



LibreOffice
Community



Draw Guide 7.3

Chapter 11, Advanced Draw Techniques

Copyright

This document is Copyright © 2022 by the LibreOffice Documentation Team. Contributors are listed below. This document maybe distributed and/or modify it under the terms of either the GNU General Public License (<https://www.gnu.org/licenses/gpl.html>), version 3 or later, or the Creative Commons Attribution License (<https://creativecommons.org/licenses/by/4.0/>), version 4.0 or later.

All trademarks within this guide belong to their legitimate owners.

Contributors

To this edition

Peter Schofield Kees Kriek

To previous editions

Martin Fox John Cleland Jean Hollis Weber
John A Smith Peter Schofield Regina Henschel

Feedback

Please direct any comments or suggestions about this document to the Documentation Team's mailing list: documentation@global.libreoffice.org



Note

Everything sent to a mailing list, including email addresses and any other personal information that is written in the message, is publicly archived and cannot be deleted.

Publication date and software version

Published May 2022. Based on LibreOffice 7.3 Community.
Other versions of LibreOffice may differ in appearance and functionality.

Using LibreOffice on macOS

Some keystrokes and menu items are different on macOS from those used in Windows and Linux. The table below gives some common substitutions for the instructions in this document. For a detailed list, see the application Help.

<i>Windows or Linux</i>	<i>macOS equivalent</i>	<i>Effect</i>
Tools > Options on Menu bar	LibreOffice > Preferences on Menu bar	Access to setup options
Right-click	Ctrl+click and/or right-click	Opens a context menu
Ctrl or Control	⌘ and/or Cmd or Command	Used with other keys
Alt	⌥ and/or Alt or Option	Used with other keys
F11	⌘+T	Open the Styles deck in the Sidebar

Contents

Copyright.....	2
Contributors.....	2
Feedback.....	2
Publication date and software version.....	2
Using LibreOffice on macOS.....	2
Drawing pages.....	6
Pages pane.....	6
Selecting pages.....	6
Navigating pages.....	7
Adding pages.....	7
Inserting new page.....	7
Duplicating pages.....	8
Renaming pages.....	8
Changing page order.....	8
Deleting pages.....	8
Master pages.....	9
Master page view.....	9
Creating master pages.....	9
Renaming master pages.....	10
Assigning master pages.....	10
Deleting master pages.....	10
Inserting fields.....	11
Editing field format.....	12
Master pages from templates.....	13
Templates.....	14
Creating drawing templates.....	14
Using Save As Template dialog.....	14
Using Save As command.....	15
Creating a drawing from templates.....	15
Start Center.....	16
Templates dialog.....	16
Default template.....	17
Setting default template.....	17
Resetting default template.....	17
Editing templates.....	17
Editing.....	18
Updating drawings from modified template.....	18
Changing templates assigned to drawings.....	18
Organizing templates.....	19
Creating template categories.....	19
Renaming template categories.....	19
Deleting template categories.....	19
Moving templates.....	20
Importing templates.....	21
Exporting templates.....	21

Deleting templates.....	22
Other ways of using templates.....	22
Drawing from a template.....	22
Template from a drawing.....	23
Multiple layers.....	23
Default layers.....	23
Normal view.....	23
Master view.....	24
Inserting layers.....	24
Modifying layers.....	24
Working with layers.....	25
Selecting a layer.....	25
Hiding layers.....	25
Showing hidden layers.....	25
Locking layers.....	26
Unlocking layers.....	26
Renaming layers.....	26
Deleting layers.....	26
Moving objects between layers.....	26
Dimensioning.....	27
Configuring dimensioning.....	27
Drawing object styles.....	27
Dimension line dialog.....	28
Dimensioning options.....	28
Guide selection handles.....	30
Dimensioning objects.....	30
Drawing to scale.....	31
Multiple views of a drawing.....	32
Gallery.....	33
Using the Gallery.....	33
Creating themes and adding images.....	34
Deleting gallery themes and images.....	35
Updating the Gallery.....	35
Renaming themes.....	35
Colors.....	35
Changing colors.....	36
Color Bar.....	36
Area dialog.....	37
Area panel on the Sidebar.....	37
Fill Color on the Line and Filling or Drawing toolbars.....	38
Line dialog.....	38
Line panel on the Sidebar.....	40
Line Color on the Line and Filling or Drawing toolbars.....	40
Changing text color.....	41
Character dialog.....	41
Character panel on the Sidebar.....	41
Creating colors.....	42
Using Pick a Color dialog.....	42

Using Area dialog.....	43
Adding custom colors.....	43
Renaming custom colors.....	43
Deleting custom colors.....	44
Bézier curves.....	44
Drawing Bézier curves.....	44
Edit Points tools.....	45
Adding comments to a drawing.....	47
Coordinate system.....	48
X and Y axes.....	48
Workspace.....	48
Object position.....	48
Accuracy.....	49

Drawing pages

Pages pane

A drawing created in Draw can consist of multiple pages allowing a drawing to be stored as one file on a computer. The drawing pages are displayed as thumbnails in the **Pages** page which is used to add, rename, delete, and arrange pages in a drawing.

By default the **Pages** page (Figure 1) appears docked on the left of the **Workspace**. If the **Pages** pane is not visible, go to **View > Page Pane** on the Menu bar. The **Pages** pane can also become a floating window using one of the following methods:

- For Windows and Linux only — press and hold the *Ctrl* key, then double-click in the title bar of the **Pages** pane to create a floating window.
- For macOS only — press and hold the ⌘ key, then double-click in the title bar of the **Pages** pane to create a floating window.
- For Windows, Linux and macOS — click in the title bar and drag the **Pages** pane to create a floating window.
- To close the **Pages** pane, click on the X on the right side of the title bar, or deselect **View > Page Pane** in the Menu bar.

Selecting pages

To make a page appear in the **Workspace**, select a page in the **Pages** pane or in the Navigator after opening the Navigator using one of the following methods to open it:

- Press the *F5* key to open the Navigator dialog (Figure 2).
- Go to **View > Navigator** on the Menu bar to open the Navigator dialog.
- Click on **Navigator** on the right of the Sidebar to open the Navigator deck (Figure 3).

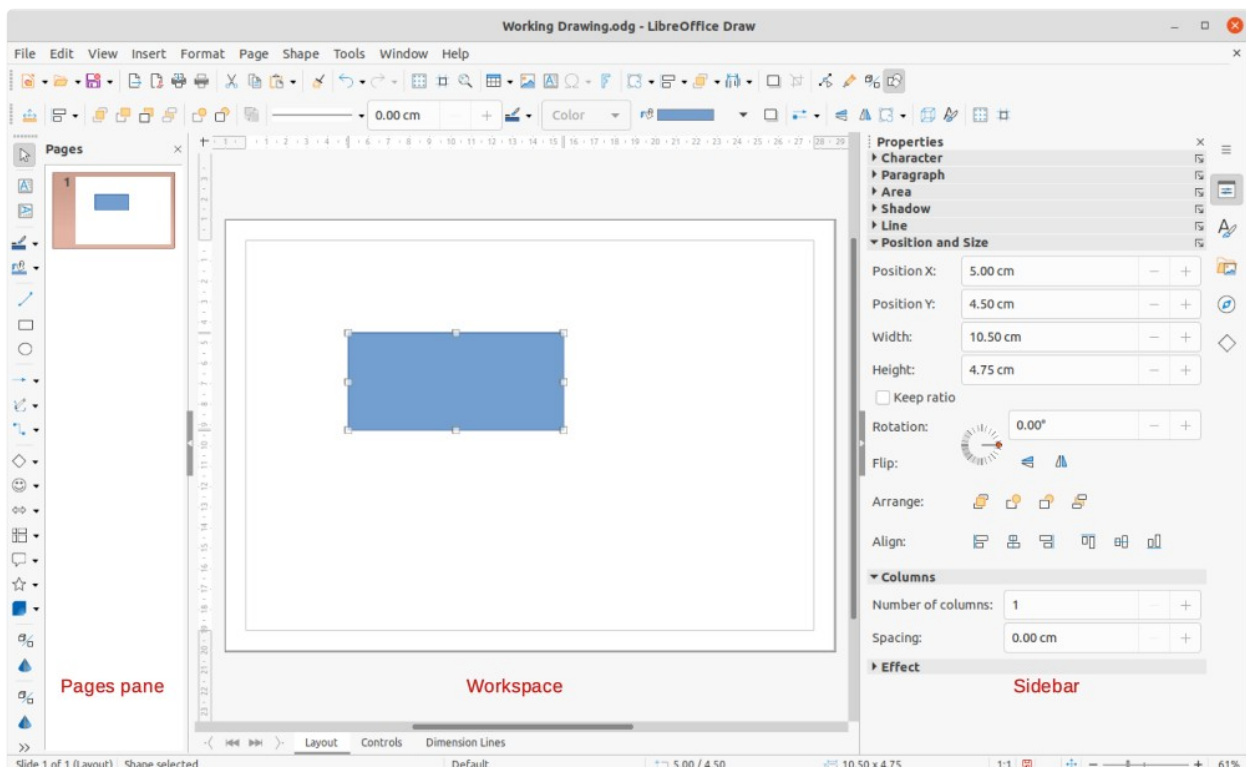

Figure 1: Draw main window

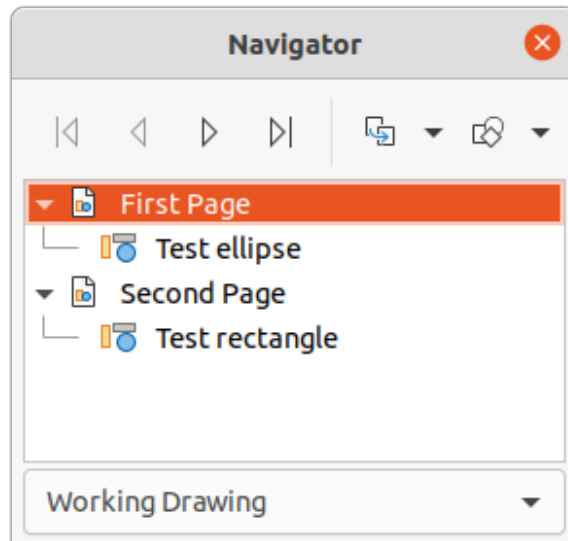

Figure 2: Navigator dialog

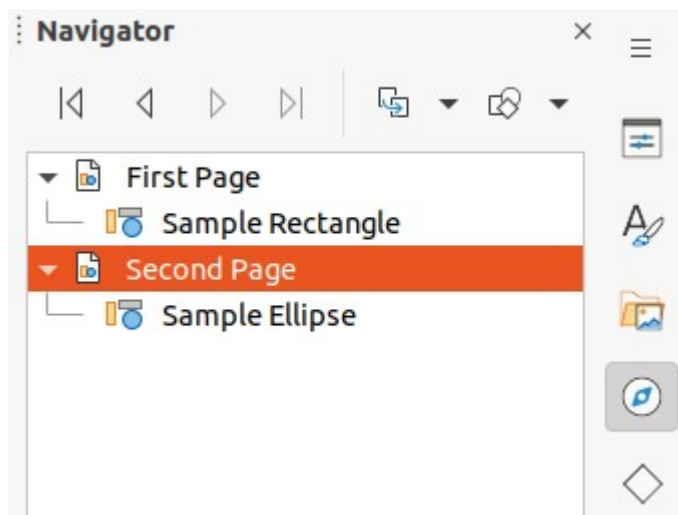

Figure 3: Navigator deck on Sidebar

Navigating pages

To quickly select a page for editing so it appears in the Workspace, either select the page in the **Pages** pane, or go to **Page > Navigate** on the Menu bar and select one of the options from the submenu:

- **To First Page** — moves the selection to the first page in the drawing.
- **To Previous Page** — moves the selection backward to the previous page.
- **To Next Page** — moves the selection forward to the next page.
- **To Last Page** — moves the selection to the last page in the drawing.

Adding pages

Inserting new page

A new page is inserted into a drawing using one of the following methods. A new page is added after the selected page in the **Pages** pane, or at the end of the pages if no page is selected.

- Go to **Page > New Page** on the Menu bar.
- Right-click in the **Pages** pane and select **New Page** from the context menu.

- Right-click on the page displayed in the **Workspace** and select **Page > New Page** from the context menu.
- Go to **Page > Insert Page from File** on the Menu bar and the Insert File dialog opens. Navigate to the folder where the file is located, select the file, click on **Open** and then click **OK**.

Duplicating pages

Select a page in the **Pages** pane, then use one of the following methods to insert the duplicate page after the selected page:

- Go to **Page > Duplicate Page** on the Menu bar.
- Right-click on a page in the **Pages** pane and select **Copy** from the context menu, then right-click in a blank area of the **Pages** pane and select **Paste** from the context menu.

Renaming pages

When pages are inserted into a drawing, they are automatically named as Page 1, Page 2, and so on in the **Pages** pane and the Navigator. As the page order is changed, pages are automatically renumbered. However, to easily identify each page, it is recommended to give each page a memorable name.

- 1) Select a page for renaming in the **Pages** pane.
- 2) Rename the selected page using one of the following methods:
 - Go to **Page** on the Menu bar and select **Rename Page** from the submenu.
 - Right-click on the selected page in the **Pages** pane and select **Rename Page** from the context menu.
 - Right-click on the page displayed in the **Workspace** and select **Page > Rename Page** from the context menu.
- 3) In the Rename Page dialog that opens, type a new name for the page and click **OK** to save.

Changing page order

- Select a page thumbnail in the **Pages** pane, then click and drag the page thumbnail to change the page order.
- Select a page thumbnail in the **Pages** pane, then go to **Page > Move** on the Menu bar and select one of the following options:
 - **Page to Start** — moves the selected page to the beginning of the drawing.
 - **Page Up** — moves the selected page up one place in the page order of the drawing.
 - **Page Down** — moves the selected page down one place in the page order of the drawing.
 - **Page to End** — moves the selected page to the end of the drawing.

Deleting pages

- 1) Select a page for deletion in the **Pages** pane.
- 2) Delete the selected page using one of the following methods:
 - Go to **Page > Delete Page** on the Menu bar.
 - Right-click on the selected page in the **Pages** pane and select **Delete Page** from the context menu.

- Right-click on the page displayed in the **Workspace** and select **Page > Delete Page** from the context menu.

✓ Note

When deleting pages in a drawing, there is no confirmation of deletion for the selected page.

Master pages

A master page is a page used as the starting point for other pages in a drawing. It is similar to a page style in Writer or master slide in Impress and controls the basic formatting of all pages based upon it. A drawing with multiple pages can have more than one master page so that a different look can be assigned to separate pages in a drawing, for example title page, contents page, and drawing pages.

A master page has a defined set of characteristics. For example, background objects (such as logos, decorative lines), formatting of text, blocks of standard text, and fields such as page numbering, date, and filename.

Master page view

To open the master page view, go to **View > Master** on the Menu bar. This also opens the Master View toolbar (Figure 4). If this toolbar does not open, go to **View > Toolbars > Master View** on the Menu bar. To return to normal page mode, click on **Close Master View** in the Master View toolbar or go to **View > Normal** on the Menu bar.

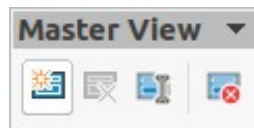

Figure 4: Master View toolbar

Creating master pages

Each drawing has a default master page. When a drawing has multiple pages, master pages can be created and added to the drawing as follows:

- 1) Go to **View > Master** on the Menu bar to open the master page view and the Master View toolbar.
- 2) Create a new master page using one of the following methods. After creation, the new master page is automatically selected.
 - Click on **New Master** in the Master View toolbar.
 - Go to **Page > New Master** on the Menu bar.
 - Right-click in the **Pages** pane and select **New Master** from the context menu.
- 3) Add the required graphic objects, logos, fields, text and so on to the selected master page, then save the drawing.
- 4) Assign the new master page to a drawing page. See “Assigning master pages” below for more information.
- 5) If necessary, rename the master page with a meaningful name, see “Renaming master pages” below.

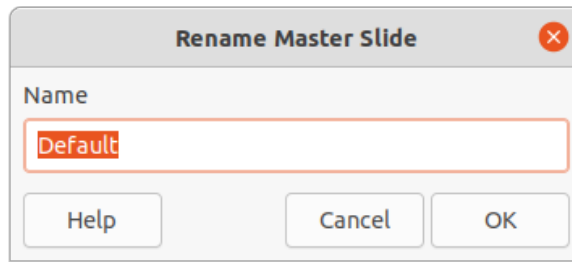

Figure 5: Rename Master Slide dialog

Renaming master pages

Each new master page created has the default name of Default 1, Default 2, and so on. It is recommended to rename a new master page with a more meaningful name. The default master page that was created when the drawing was first created can also be renamed.

- 1) Go to **View > Master** on the Menu bar to open the master page view and the Master View toolbar.
- 2) Open the Rename Master Slide dialog (Figure 5) using one of the following methods:
 - Click on **Rename Master** in the Master View toolbar.
 - Right-click on a master page in the **Pages** pane and select **Rename Master** from the context menu.
- 3) Enter a meaningful name for the master page in the **Name** text box, then click **OK** to save the changes and close the Rename Master Slide dialog.

Assigning master pages

When a drawing has more than one master page, different master pages can be assigned to different pages.

- 1) Go to **View > Normal** on the Menu bar.
- 2) In the **Pages** pane, select the page to assign a master page to it.

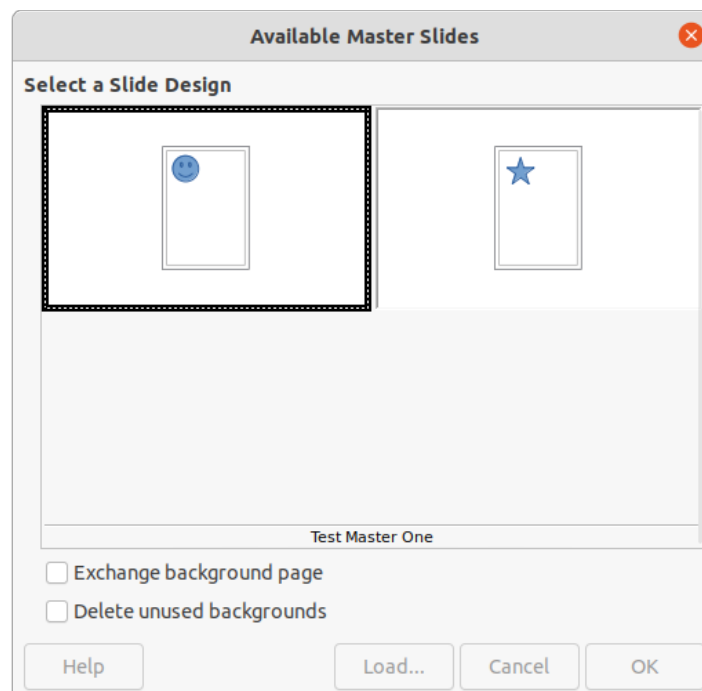

Figure 6: Available master Slides dialog

- 3) Right-click on the page in the **Workspace** and select **Change Slide Master** from the context menu to open the Available Master Slides dialog (Figure 6).
- 4) Select a master page design for the selected page in **Select a Slide Design**.
- 5) If necessary, select **Exchange background page** to use the selected master page for all pages in the drawing.
- 6) If necessary, select **Delete unused backgrounds** to delete any master pages shown in **Select a Slide Design** that have not been assigned to a page.
- 7) Click **OK** to assign the selected master page and close the Available Master Slides dialog.

Deleting master pages

The default master page created when the drawing was first created cannot be deleted. Also, if the drawing only uses one named master page, then that named master page cannot be deleted. Deleting master pages is only available when there is more than one master page in a drawing.

- 1) Go to **View > Master** on the Menu bar to open the master page view and the Master View toolbar.
- 2) Delete a master page using one of the following methods:
 - Select and right-click on a master page in the **Pages** pane, then select **Delete Master** from the context menu.
 - Click on **Delete Master** in the Master View toolbar.
 - Go to **Page > Delete Master** on the Menu bar.

Note

The deletion of the master page is immediate and there is no confirmation.

Inserting fields

- 1) Go to **View > Master** on the Menu bar to open the master page view and the Master View toolbar.
- 2) Go to **Insert > Field** on the Menu bar and select a field type from the options available on the submenu.

The field types that are available for insertion as follows:

- **Date (fixed)** — inserts the current date into the master page as a fixed field. The date is not automatically updated.
- **Date (variable)** — inserts the current date into the master page as a variable field. The date is automatically updated each time the file is opened.
- **Time (fixed)** — inserts the current time into the master page as a fixed field. The time is not automatically updated.
- **Time (variable)** — inserts the current time into the master page as a variable field. The time is automatically updated each time the file is opened.
- **Author** — inserts the first and last names listed in the LibreOffice user data into the active page. Go to **Tools > Options > LibreOffice > User Data** (macOS **LibreOffice > Preferences > LibreOffice > User Data**) on the Menu bar to enter user data details.

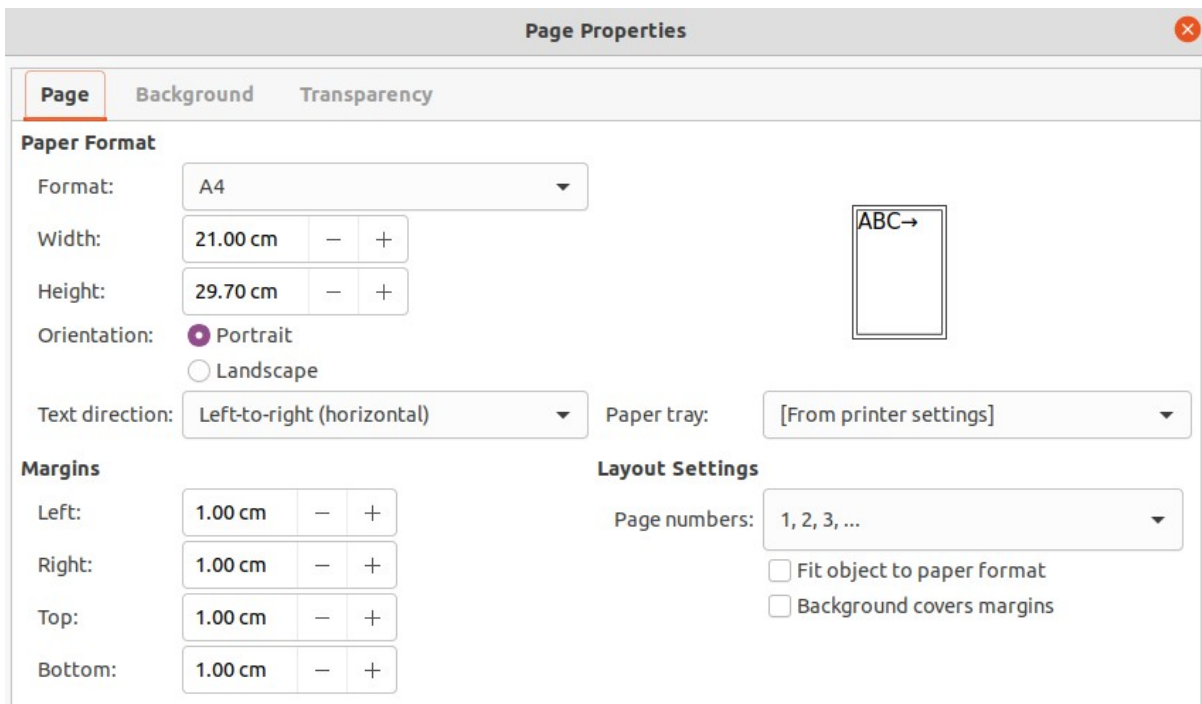

Figure 7: Page Properties dialog

- **Page Number** — inserts the page number into every page of the drawing. To change the number format, go to **Page > Page Properties** on the Menu bar to open the Page Properties dialog (Figure 7). Click on the **Page** tab and select a number format from the drop-down list in **Layout Settings**.
- **Page Title** — inserts the page title. A page title is created in Normal view by going to **Page > Rename Page** on the Menu bar and entering a title in the *Name* text box in the Rename Page dialog that opens.
- **Page Count** — inserts the total number of pages in a drawing.
- **File Name** — inserts the name of the active file. The name only appears after the file has been saved.

Editing field format

- 1) Click on a field to select it and display the selection handles.
- 2) Double click on the field contents to select the text.
- 3) Edit the field format using one of the following methods:
 - Go to **Edit > Fields...** on the Menu bar to open the Edit Field dialog (Figure 8), then select format option(s) and click **OK** to save the changes.
 - Right-click on the selected field contents and select an option from the context menu.
- 4) Click in a blank area of the master page to deselect the field.

✓ Note

The options available in the Edit Field dialog change to match the field type that has been selected for editing.

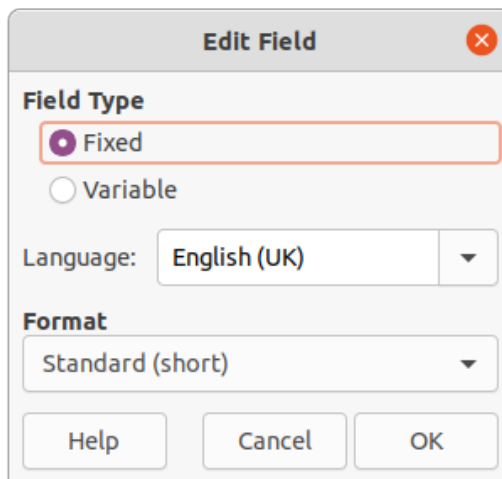

Figure 8: Edit Field dialog

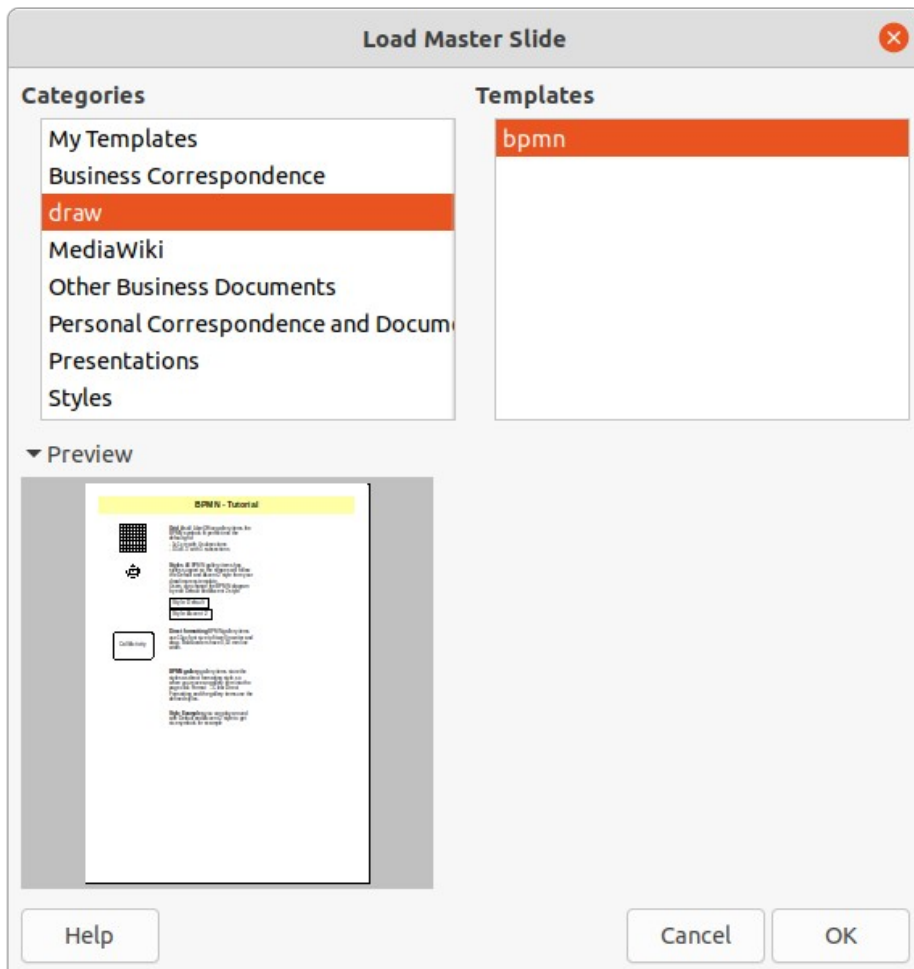

Figure 9: Load Master slide dialog

Master pages from templates

Master pages from templates available in LibreOffice can be loaded into a drawing and used. If the master pages from a template use a different page size, the master pages loaded into a drawing are adapted to the page size used in the drawing. This may cause some objects to be stretched or incorrectly positioned when adapted to fit the drawing page size.

- 1) Go to **View > Master** on the Menu bar to open the master page view and the Master View toolbar.

- 2) Right-click on a master page displayed in the drawing and select **Change Master Slide** from the context menu to open the Available Master Slides dialog.
- 3) Click on **Load...** in the Available Master Slides dialog to open the Load Master Slide dialog (Figure 9).
- 4) Chose a template category from list displayed in **Categories**.
- 5) Choose a template from the list displayed in **Templates**. Click **Preview** to display a preview of the selected template.
- 6) Click **OK** to close the Load Master Slide dialog and the Available Master Slides dialog opens displaying the template in **Select a Slide Design**.
- 7) Select the master page design required in **Select a Slide Design**.
- 8) If necessary, select **Exchange background page** to use the selected master page for all pages in the drawing.
- 9) If necessary, select **Delete unused backgrounds** to delete any master pages shown in Select a Slide Design that have not been assigned to a page.
- 10) Click **OK** to assign the selected master page to a drawing page and close the Available Master Slides dialog.

Templates

A template is a special type of drawing that is used as a basis to create a drawing. For example, a template can include a company logo, name and information on the first page of a drawing with the remaining pages in a drawing only showing the company logo and name. Templates can contain anything that regular drawings can contain, such as text, graphics, a set of styles, and so on.

All document types created using LibreOffice are based on templates. If a template is not specified when a new document is started, then the default template for that type of document is used. This default template uses a set of properties that are hard coded in LibreOffice. If necessary, the default template for drawings that is hard coded in LibreOffice can be changed, see "Default template" on page 17 for more information.

For more information on templates and obtaining templates from other sources, see the *Getting Started Guide*.

Draw does not have any predefined templates when it is installed on a computer. However, templates can be created using methods described in the following sections. Templates can also be installed that have been obtained from other sources, see "Importing templates" on page 21 for more information.

Creating drawing templates

Using Save As Template dialog

- 1) Open a drawing to use as a basis for a template, or open and edit a template to use as a basis for a new template.
- 2) Add any extra content and styles or edit the content and styles in the drawing.
- 3) Open the Save As Template dialog (Figure 10) using one of the following methods:
 - Go to **File > Templates > Save As Template** on the Menu bar.
 - Click on the triangle ▼ to the right of **Save** on the Standard toolbar and select **Save as Template** from the drop-down menu.
- 4) Enter a name for the template in the **Template Name** text box.
- 5) Select a category for the template in the **Template Category** box.

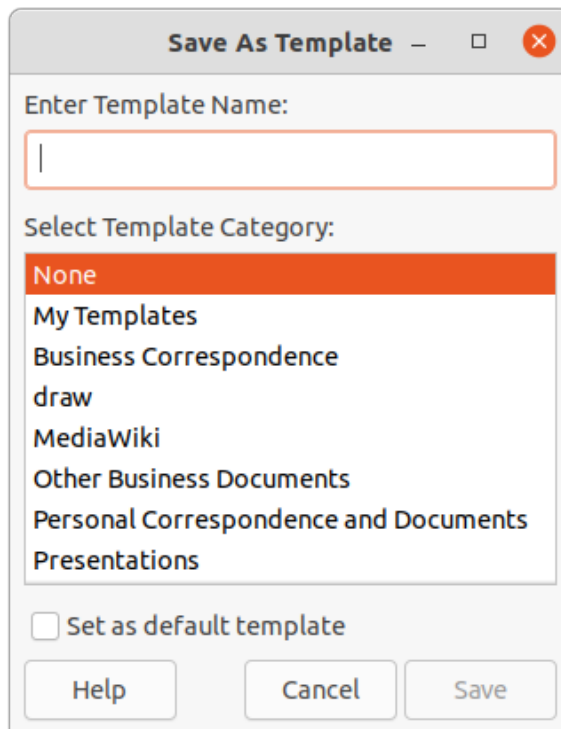

Figure 10: Save As Template dialog

- 6) If the template is to be used as the default template in Draw, then select the option **Set as default template**.
- 7) Click on **Save** to save the template and close the dialog.

Using Save As command

Alternatively, the command **Save As** can be used to save the drawing as a template using the following procedure:

- 1) Go to **File > Save As** on the Menu bar to open the Save as dialog.
- 2) Navigate to the LibreOffice templates folder. Actual location of the LibreOffice template folder depends on the computer system and setup.
- 3) Enter a filename using the extension .otg.
- 4) Select ODF Drawing Template (.otg) as the file type.
- 5) Click on **Save** to save the template and close the dialog.

Note

When saving a drawing as a template, the template must be saved in the LibreOffice templates folder for the template to be recognized and found by the LibreOffice Template Manager.

Creating a drawing from templates

Instead of using the default settings in LibreOffice to create a new drawing, a drawing can be created from a template.

Start Center

Open LibreOffice and create a new drawing from a template displayed in the **Start Center** using one of the following methods:

- Click on **Templates** in the **Start Center** to open a display of available templates for all LibreOffice applications. Click on a template and a new document opens using the relevant LibreOffice module application for the template.
- Click on the triangle ▼ to the right of **Templates** in the **Start Center**, then select **Draw Templates** to display only the available templates for LibreOffice Draw. Click on a template and a new drawing opens using LibreOffice Draw.

Templates dialog

Instead of using the default settings in LibreOffice to create a new drawing, the Templates dialog (Figure 11) can be used as follows:

- 1) Use one of the following methods to open the Templates dialog:
 - Go to **File > New > Templates** on the Menu bar.
 - Go to **File > Templates > Manage Templates** on the Menu bar.
 - Use the keyboard short cut *Ctrl+Shift+N* (macOS *⌘+Shift+N*).
- 2) In the **Filter** drop-down lists, select Draw as the application and the template category required for the new drawing.
- 3) Select a template from the options available in the preview box.
- 4) Click **Open** or double click on the template to create a new drawing using the selected template and close the Template dialog.
- 5) Go to **File > Save As** on the Menu bar and save the new drawing as a file using the extension .odg.

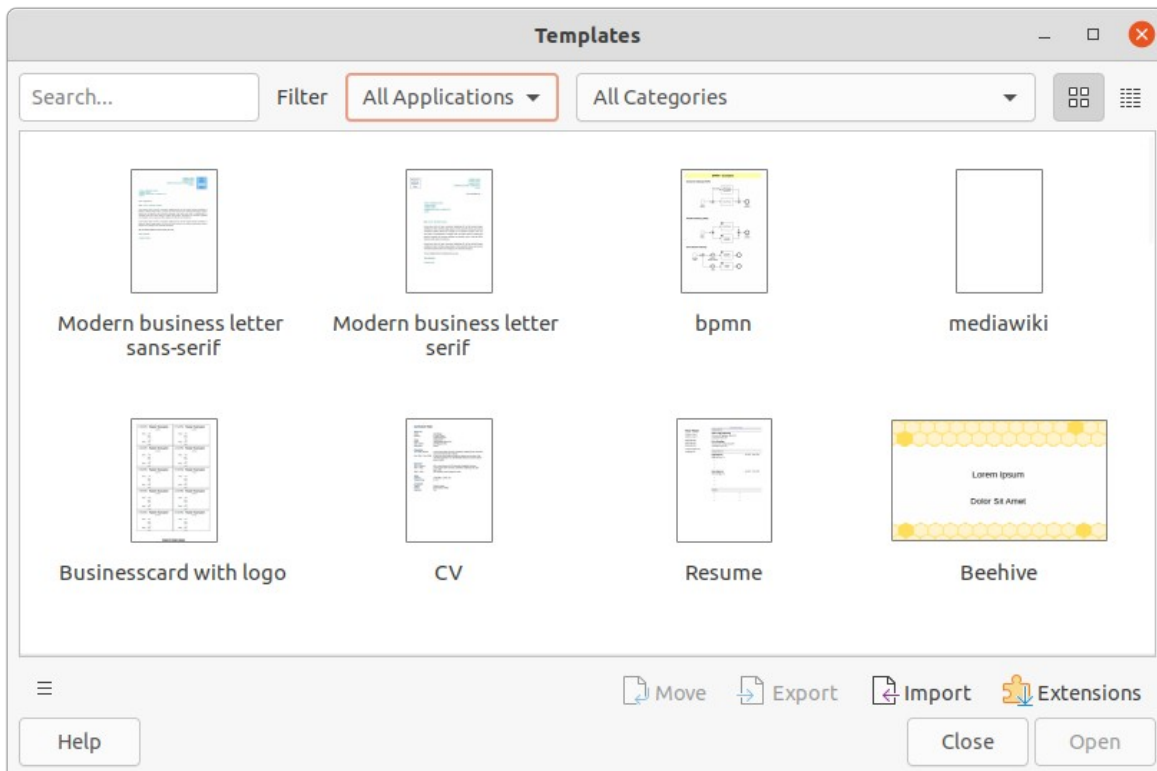

Figure 11: Templates dialog

Default template

If a new drawing is created without selecting a template, LibreOffice creates the drawing using a set of properties that are hard coded in LibreOffice. However, any drawing template can be used as the default template, but the template must be located in the templates folders used for LibreOffice applications and categories.

Setting default template

- 1) Use one of the following methods to open the Templates dialog:
 - Go to **File > New > Templates** on the Menu bar.
 - Go to **File > Templates > Manage Templates** on the Menu bar.
 - Use the keyboard short cut *Ctrl+Shift+N* (macOS *⌘+Shift+N*).
- 2) In the **Filter** drop-down lists, select **Drawings** and then the template category.
- 3) Select a template from the templates displayed in the preview box.
- 4) Right-click on the template and select **Set as default** from the context menu. There is no confirmation that the selected template has become the default template for new drawings. The default template is indicated by check mark at the top left corner of the template icon.
- 5) Click on **Cancel** to close the Templates dialog. The next time a new drawing is created, it will use the new default template.



Note

If a new drawing is suitable to use as the default template, then the drawing must be saved as a template first before it can be used as the default template. See “Creating drawing templates” on page 14 for more information.

Resetting default template

- 1) Use one of the following methods to open the Templates dialog:
 - Go to **File > New > Templates** on the Menu bar.
 - Go to **File > Templates > Manage Templates** on the Menu bar.
 - Use the keyboard short cut *Ctrl+Shift+N* (macOS *⌘+Shift+N*).
- 2) In the **Filter** drop-down lists, select **Drawings** and then the template category.
- 3) Right-click on the default template. The default template is indicated by check mark at the top left corner of the template icon.
- 4) Select **Reset Default** from the context menu. There is no confirmation that Draw has been reset to using LibreOffice default properties for creating a new drawing. The check mark is removed from the template icon.
- 5) Click on **Cancel** to close the Templates dialog. The next time a new drawing is created, it will use the LibreOffice default properties.

Editing templates



Note

Templates that were supplied with LibreOffice cannot be edited or deleted. Only templates that have been created using LibreOffice or imported into LibreOffice can be edited or deleted.

Template styles and template content can be edited, and then, if necessary, reapplied to drawings that were created from that template. Any content in the drawing, but not included in the template, cannot be reapplied.

Editing

- 1) Use one of the following methods to open the Templates dialog:
 - Go to **File > New > Templates** on the Menu bar.
 - Go to **File > Templates > Manage Templates** on the Menu bar.
 - Use the keyboard short cut *Ctrl+Shift+N* (macOS *⌘+Shift+N*).
- 2) Select a template that was created using LibreOffice or imported into LibreOffice.
- 3) Right-click on the selected template and select **Edit** from the context menu. The template opens in Draw.

Note

If the **Edit** option is greyed out, then the selected template is part of the LibreOffice installation and cannot be edited.

- 4) Edit the template as any other drawing.
- 5) Go to **File > Save** on the Menu bar or use the keyboard shortcut *Ctrl+S* (macOS *⌘+S*) to save the template.
- 6) Alternatively, save the edited template as a new template. See “Creating drawing templates” on page 14 for more information.

Updating drawings from modified template

The next time a drawing is opened created from the modified template, a confirmation dialog opens asking to update the styles in the drawing to the formatting used in the modified template.

- Click **Update Styles** to update any styles in the drawing that have been changed in the template and close the confirmation dialog.
- Click **Keep Old Styles** so that styles in the drawing that have been changed in the template are not updated. The confirmation dialog closes and will not appear again the next time the document is opened.

Note

If **Keep Old Styles** is selected, the drawing is no longer connected to the template. However, the template is still listed under **File > Properties > General**. To reconnect the document to the template, the template has to be reassigned. See “Changing templates assigned to drawings” below for more information.

Changing templates assigned to drawings

If necessary, the template associated with a drawing can be changed to a different template, or reassign the original template for the drawing back to the drawing.

- To manually change or reassign a template, create a new drawing from the required template and copy the contents from the old drawing into the new drawing.
- Download the Template Changer extension from the LibreOffice website at <https://extensions.libreoffice.org/en/extensions/show/template-changer> and install it into LibreOffice. Restart LibreOffice to activate the extension. Open the drawing and use **File > Templates > Change template (current document)** on the Menu bar to change the template. For more information, see the *Getting Started Guide*.

Organizing templates

LibreOffice can only locate templates that are in LibreOffice template folders (categories). New LibreOffice template categories can be created and used to organize templates, for example creating separate categories for different projects or clients. Templates can also be imported and exported.

Tip

The location of LibreOffice template folders varies with the computer operating system. To learn where the template folders are stored on a computer, go to **Tools > Options > LibreOffice > Paths** (macOS **LibreOffice > Preferences > LibreOffice > Paths**) on the Menu bar.

Creating template categories

- 1) Use one of the following methods to open the Templates dialog:
 - Go to **File > New > Templates** on the Menu bar.
 - Go to **File > Templates > Manage Templates** on the Menu bar.
 - Use the keyboard short cut *Ctrl+Shift+N* (macOS *⌘+Shift+N*).
- 2) In the **Filter** drop-down lists, select **Drawings** as the application.
- 3) Click on **Tools** in the bottom left corner and select **New Category** from the context menu.
- 4) Enter a name in the **Enter category name** text box in the dialog that opens.
- 5) Click **OK** to save the new category in LibreOffice and close the dialog.

Renaming template categories

Template categories supplied with LibreOffice cannot be renamed. Only template categories that have been created can be renamed.

- 1) Use one of the following methods to open the Templates dialog:
 - Go to **File > New > Templates** on the Menu bar.
 - Go to **File > Templates > Manage Templates** on the Menu bar.
 - Use the keyboard short cut *Ctrl+Shift+N* (macOS *⌘+Shift+N*).
- 2) In the **Filter** drop-down lists, select **Drawings** as the application and the template category for renaming.
- 3) Click on **Tools** in the bottom left corner and select **Rename Category** from the context menu.
- 4) Enter a name in the **Enter category name** text box in the dialog that opens.
- 5) Click **OK** to save the renamed category in LibreOffice and close the dialog.

Note

If an attempt to rename a category that was installed with LibreOffice is made, an error message opens stating that the category cannot be renamed.

Deleting template categories

Template categories supplied with LibreOffice cannot be deleted. Only template categories that have been created manually can be deleted.

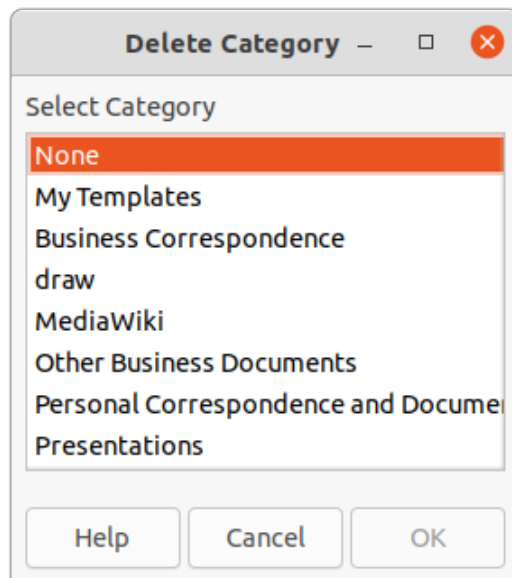

Figure 12: Delete Category dialog

- 1) Use one of the following methods to open the Templates dialog:
 - Go to **File > New > Templates** on the Menu bar.
 - Go to **File > Templates > Manage Templates** on the Menu bar.
 - Use the keyboard short cut *Ctrl+Shift+N* (macOS *⌘+Shift+N*).
- 2) Click on **Settings** and select **Delete Category** from the context menu.
- 3) Select the category in the Delete Category dialog (Figure 12) that opens.
- 4) Click **OK** to delete the selected category and close the Delete Category dialog.
- 5) Click **Yes** to confirm the deletion of the category.

✓ Note

If an attempt to delete a category that was installed with LibreOffice is made, an error message opens stating that the category cannot be deleted.

Moving templates

A template is moved from one template category to another template category as follows:

- 1) Use one of the following methods to open the Templates dialog:
 - Go to **File > New > Templates** on the Menu bar.
 - Go to **File > Templates > Manage Templates** on the Menu bar.
 - Use the keyboard short cut *Ctrl+Shift+N* (macOS *⌘+Shift+N*).
- 2) In the **Filter** drop-down lists, select **Drawings** as the application and the template category where the template is located.
- 3) Select the template that is going to be moved.
- 4) Click on **Move** and the Select Category dialog (Figure 13) opens.
- 5) Select a category from **Select from Existing Category** or enter a name for a new category in **Create a New Category**.
- 6) Click **OK** to move the template to the selected category and close the Select Category dialog.

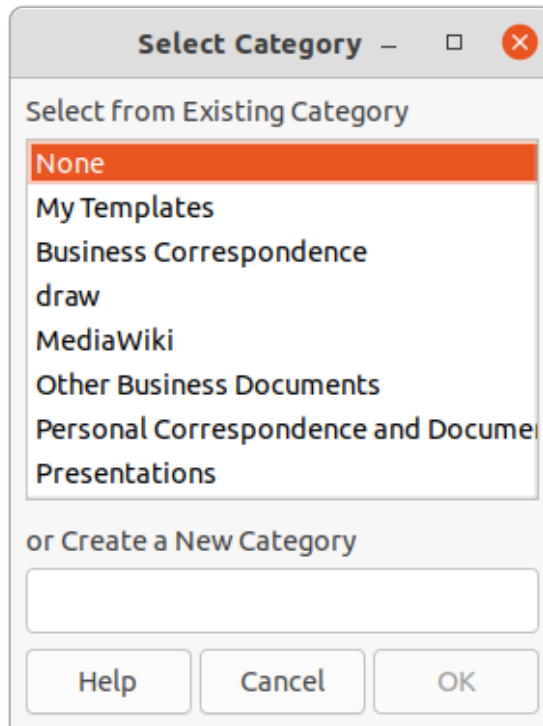

Figure 13: Select Category dialog

Importing templates

Templates can be downloaded from many sources, including the official LibreOffice template repository using the Extension Manager. Save the template anywhere on a computer, then import the template into LibreOffice as follows:

- 1) Use one of the following methods to open the Templates dialog:
 - Go to **File > New > Templates** on the Menu bar.
 - Go to **File > Templates > Manage Templates** on the Menu bar.
 - Use the keyboard short cut *Ctrl+Shift+N* (macOS *⌘+Shift+N*).
- 2) Click on **Import** and the Select Category dialog opens.
- 3) Select a category from **Select from Existing Category** or enter a name for a new category in **Create a New Category**.
- 4) Click **OK** and a file browser window opens.
- 5) Navigate to the folder containing the template, select the template and click **Open**. The file browser closes and the template appears in the selected template category in the Templates dialog.

Note

For more information about using the Extension Manager to import templates, see the *Getting Started Guide*.

Exporting templates

Export a template from a template category to another location in a computer or network as follows:

- 1) Use one of the following methods to open the Templates dialog:
 - Go to **File > New > Templates** on the Menu bar.

- Go to **File > Templates > Manage Templates** on the Menu bar.
 - Use the keyboard short cut *Ctrl+Shift+N* (macOS *⌘+Shift+N*).
- 2) In the **Filter** drop-down lists, select **Drawings** as the application and the template category where the template is located.
 - 3) Select a template for export and click **Export** to open a file browser window.
 - 4) Navigate to the folder to export the template into.
 - 5) Click **OK** and the exported template appears in the selected folder.
 - 6) Click **Cancel** to close the Templates dialog.

Note

Exporting a template does not remove it from the Templates dialog. The action places a copy of the template in the location specified.

Deleting templates

- 1) Use one of the following methods to open the Templates dialog:
 - Go to **File > New > Templates** on the Menu bar.
 - Go to **File > Templates > Manage Templates** on the Menu bar.
 - Use the keyboard short cut *Ctrl+Shift+N* (macOS *⌘+Shift+N*).
- 2) In the **Filter** drop-down lists, select **Drawings** as the application and the template category where the template is located.
- 3) Right-click on the template for deletion and select **Delete** from the context menu.
- 4) Click **Yes** to confirm the deletion of the template.
- 5) Click **Cancel** to close the Templates dialog.

Tip

Press the *Delete* or *Backspace* key on the keyboard to delete the selected template in the Templates dialog

Note

Templates that were installed with LibreOffice cannot be deleted. Only templates that have been created after the installation of LibreOffice can be deleted.

Other ways of using templates

Templates can be created and stored anywhere on a computer and then used without involving the Templates dialog. However, some results maybe different from those described above.

Drawing from a template

Create a drawing from a compatible template by double-clicking the template in a file browser window. The resulting drawing is not associated with (linked to) the template from which it was created. The template is not listed in the properties of the document and any changes to the template cannot be directly applied to the document. For many purposes, this may be what is required.

Template from a drawing

Create a template from a drawing using **File > Save As** on the Menu bar and selecting ODF Drawing Template (.otg) as the file type, then saving it anywhere on a computer, for example in a project folder.

The resulting template is visible in the Templates dialog, unless it is imported it or added to the project folder to the locations shown for templates in **Tools > Options > LibreOffice > Paths** (macOS **LibreOffice > Preferences > LibreOffice > Paths**). See “Organizing templates” on page 19 and “Importing templates” on page 21 for more information.

Multiple layers

Layers in LibreOffice Draw allow assembly of elements in a drawing that are related. Think of layers as individual workspaces that can be hidden from view, prevented from printing, or locked so that changes cannot be made.

Layers do not determine the stacking order of objects on a drawing, except for the **Controls** layer which is always in front of all other layers. The stacking order of objects on a drawing is determined by the sequence in objects are added. This stacking order can be rearranged by going to **Shape > Arrange** on the Menu bar.

Layers in a drawing are indicated by tabs located at the bottom of the **Workspace** and above the **Status bar**. Click on a tab to select a layer. Figure 14 shows the **Layout** layer has been selected.

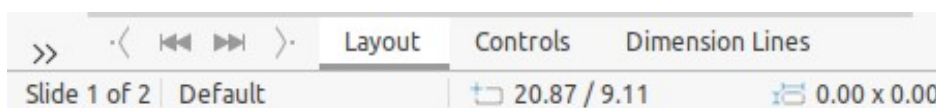

Figure 14: Layer tabs in Workspace

✓ Note

When a new layer is added, the layer is added to all pages in a drawing. However, when an object is added to a layer, the object is only added to the selected drawing page.

✓ Note

If an object is to appear on all pages of a drawing (for example, a company logo), add the object to the master page by going to **View > Master** on the Menu bar. See “Master pages” on page 9 for more information.

Default layers

Normal view

In Normal view, LibreOffice Draw provides three default layers that are visible to the user. These default layers cannot be deleted or renamed.

- **Layout** – is the default workspace where objects are normally placed.
- **Controls** – used for form controls that have been assigned an action. Objects on this layer are always in front of objects on other layers. Normally, form controls would not be printed and the **Printable** option in the Modify Layer dialog has to be deselected.
- **Dimension Lines** – is where the dimension lines are drawn. By switching the layer between show or hide, dimension lines are switched on and off.

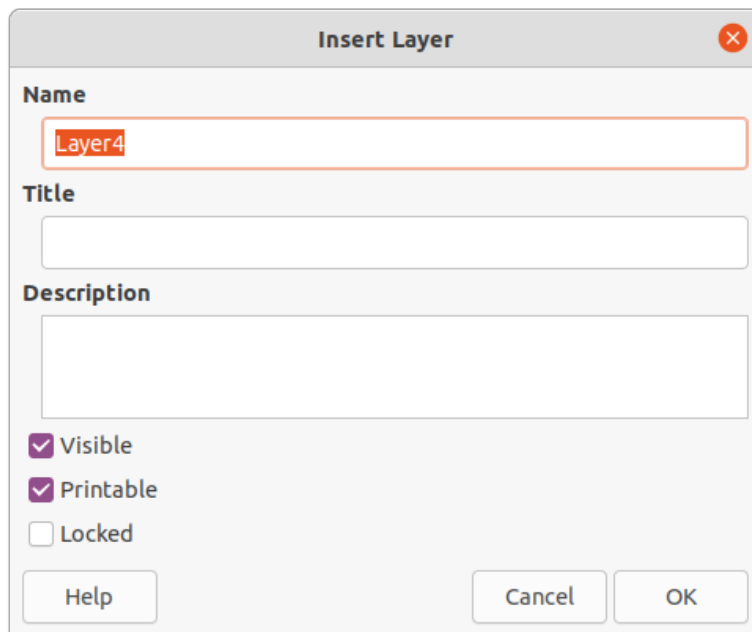

Figure 15: Insert Layer dialog

Master view

In Master view, LibreOffice provides a single layer, **Background objects**, that is visible to the user. This layer is used to place objects that appear on every page in a drawing, for example company logo, date, page number, drawing title, and so on.

Inserting layers

- 1) Use one of the following methods to open the Insert Layer dialog (Figure 15):
 - Right-click the layer tab area at the bottom of the Workspace area and select **Insert Layer** from the context menu.
 - Go to **Insert > Layer** on the Menu bar.
- 2) Enter meaningful names for the layer in the **Name** and **Title** text boxes.
- 3) If necessary, enter a description for the new layer in the **Description** text box.
- 4) Select **Visible** for the layer to be visible in a drawing. When **Visible** is not selected, the layer is hidden and its name in the layer tab changes color to blue.
- 5) Select **Printable** for the layer to print when the drawing is printed. The name of a layer is underlined in the layer tab bar when **Printable** is NOT selected. For example, not printing a layer is useful if the layer is a draft layer for guides or annotations used in creating the drawing, but this draft layer is not required for the final printed output.
- 6) Select **Locked** to prevent any objects on a layer from deletion, editing, or moving. No additional objects can be added to a locked layer. For example, locking a layer is useful when a base plan is to be protected while adding a new layer with other details. The name of a locked layer is changes to italic text in the layer tab bar.
- 7) Click **OK** to close the Insert Layer dialog and the new layer automatically becomes active.

Modifying layers

- 1) Use one of the following methods to open the Modify Layer dialog (Figure 16).
 - Right-click the name tab for the layer at the bottom of the Workspace and select **Modify Layer** from the context menu.

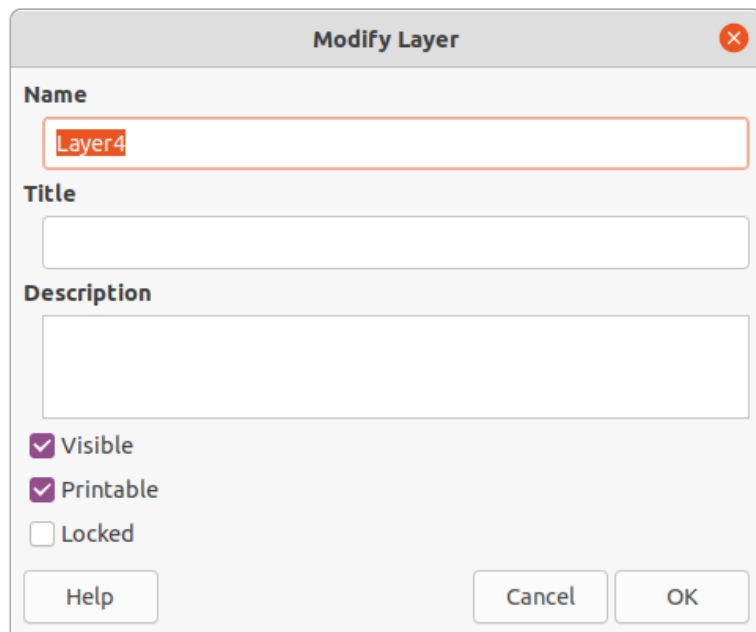

Figure 16: Modify Layer dialog

- Click on the layer tab to select it, then go to **Format > Layer** on the Menu bar.
 - Double click on the layer tab.
- 2) Make the necessary changes to the attributes for the layer, then click **OK** to save the changes and close the Modify Layer dialog.

Working with layers

Selecting a layer

To select a layer, click on the name tab for the layer at the bottom of the **Workspace**. When a layer is selected it is activated, and any objects added to the drawing are only added to that layer. Form controls are automatically added to the **Controls** layer and dimension lines are automatically added to the **Dimension Lines** layer.

If there are several layers in a drawing, a layer tab may not be visible on the layer tab bar. Use the navigation icons on the left of the layer tab bar to navigate to the layer for selection.

Hiding layers

- 1) Select the layer that is going to be hidden and open the Modify Layer dialog. See “Modifying layers” above for more information.
- 2) Deselect **Visible** and click **OK**. The text on the layer name tab changes color to blue. Any objects placed on a hidden layer are no longer visible on the other layers in the drawing.
- 3) Alternatively, hold down the *Shift* key and click on the layer name tab to hide the layer.

Showing hidden layers

- 1) Select the hidden layer and open the Modify Layer dialog. See “Modifying layers” above for more information.
- 2) Select **Visible** and click **OK**. The text on the layer name tab changes color to the default text color. Any objects placed on a hidden layer are now visible on the other layers in a drawing.
- 3) Alternatively, hold down the *Shift* key and click on the name tab of a hidden layer to make the layer visible.

Locking layers

- 1) Select the layer that is going to be locked and open the Modify Layer dialog. See “Modifying layers” above for more information.
- 2) Select **Locked** and click **OK**. The text on the layer name tab is underlined. Locking a layer prevents any modification of the layer.
- 3) Alternatively, hold down the *Ctrl* (macOS ⌘) key and click on the name tab to lock the layer.

Unlocking layers

- 1) Select the locked layer and open the Modify Layer dialog. See “Modifying layers” above for more information.
- 2) Deselect **Locked** and click **OK**. The text on the layer name tab is no longer underlined.
- 3) Alternatively, hold down the *Ctrl* (macOS ⌘) key and click on the name tab of the locked layer to unlock it.

Renaming layers

- 1) Select the layer that is going to be renamed and open the Modify Layer dialog.
- 2) Enter a new name in the **Name** text box. See “Modifying layers” above for more information.
- 3) Alternatively, right-click on the name tab of the layer and select **Rename Layer** from the context menu. The text becomes editable allowing the name to be changed. Click outside the tab area to save the change.
- 4) Alternatively, hold down the *Alt* key (macOS ⌥) and click on the name tab. The text becomes editable allowing the name to be changed. Click outside the tab area to save the change.



Note

Only layers that have been added to a drawing can be renamed or deleted. The default layers **Layout**, **Controls**, **Dimension Lines** and **Background objects** cannot be renamed or deleted.

Deleting layers

- 1) Right-click on the name tab of the layer that is going to be deleted and select **Delete Layer** from the context menu.
- 2) Confirm the deletion of the layer. The layer and all of the objects on the layer are deleted.

Moving objects between layers

If objects are selected on a layer, the **Status bar** indicates how many objects are selected. Move these selected objects from one layer to another layer using one of the following methods:

- Click and drag the selected objects to the name tab of the destination layer and release the cursor. The position of the moved objects does not change and the layer where the objects have been placed is displayed in the **Status bar**.
- Go to **Edit > Cut** on the Menu bar or right-click on the selected objects and select **Cut** from the context menu. Select the destination layer, then go to **Edit > Paste** on the Menu bar or right-click on the **Workspace** and select **Paste** from the context menu. The position of the moved objects does not change and the layer where the objects have been placed is displayed in the **Status bar**.

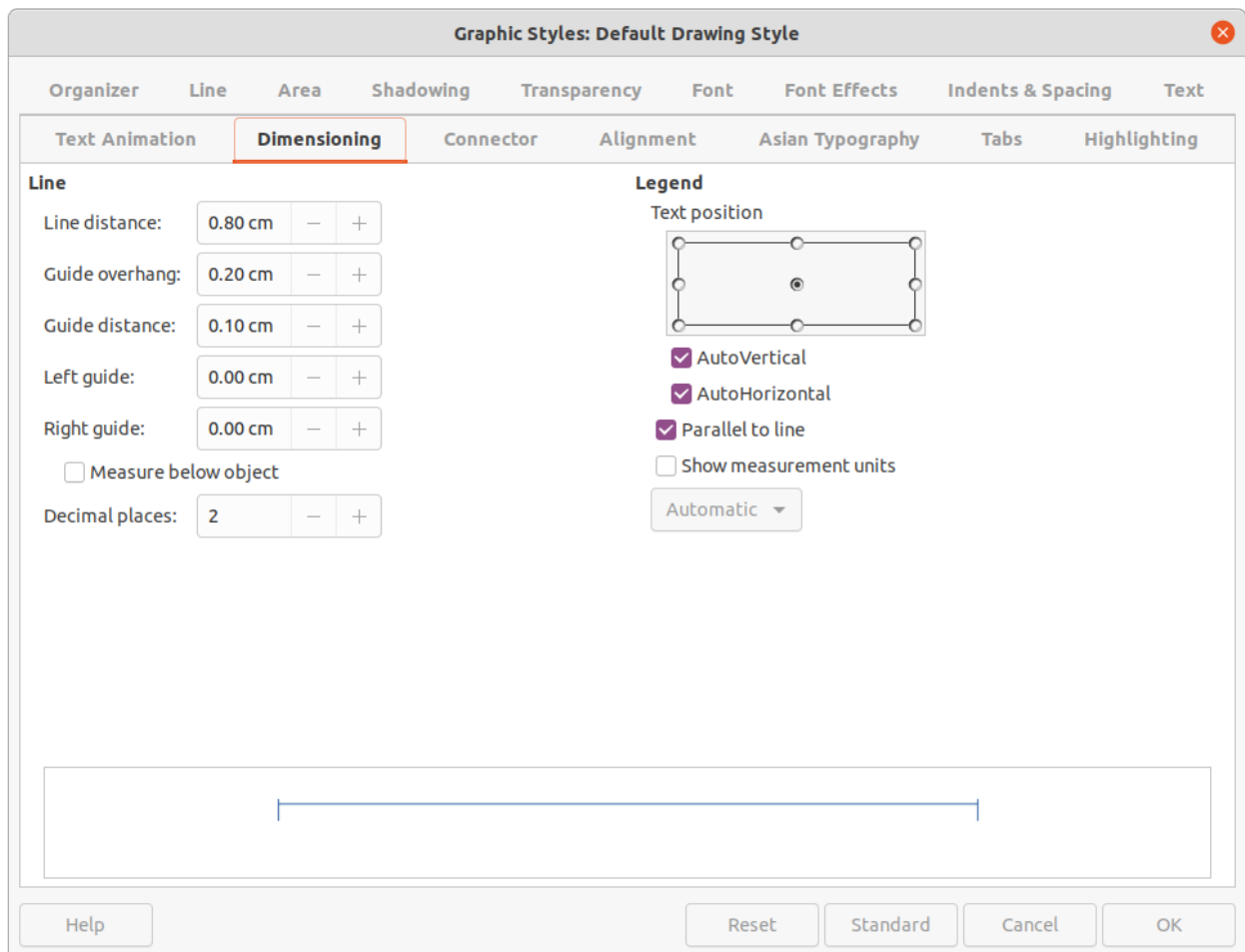

Figure 17: Graphic Styles dialog - Dimensioning page

Dimensioning

Draw allows objects to be dimensioned and display these dimensions to make a drawing look more like an engineering drawing. When dimensions are created, they are automatically placed on the **Dimension Lines** layer.

Configuring dimensioning

Two ways are available to access the options to configure dimensioning. Both methods use a dialog where the length, measurement, and guide properties of a dimension line can be changed.

Drawing object styles

- 1) Open the Graphics Styles dialog (Figure 17) using one of the following methods:
 - Go to **Format > Styles > Edit Styles** on the Menu bar.
 - Click on **Show the Styles Sidebar** on the Line and Filling toolbar to open the Styles deck on the Sidebar, then right-click on a style and select **Modify** from the context menu.
 - Use the keyboard shortcut *F11* (macOS $\text{⌘}+T$) to open the Styles deck on the Sidebar, then right-click on a style and select **Modify** from the context menu.
 - Click on **Styles** on the Sidebar to open the Styles deck, then right-click on a style and select **Modify** from the context menu.
- 2) Click on **Dimensioning** to open the **Dimensioning** page in the dialog.

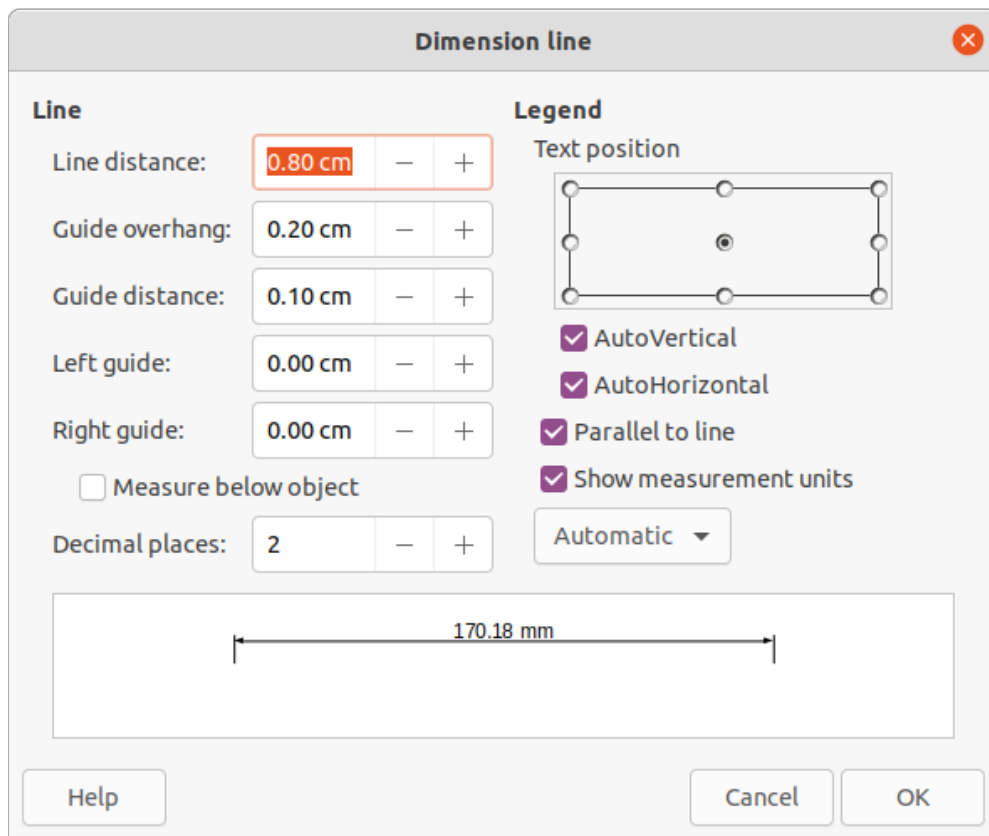

Figure 18: Dimension Line dialog

- 3) Make the changes required to dimensioning using the various options in the **Line** and **Legend** sections on the **Dimensioning** page.
- 4) Click **OK** to save the changes and close the Graphic Styles dialog.
- 5) To reset the dimensioning options to the default properties of the template, open the Graphics Style dialog as given in Steps 1 and 2 above, then click on **Standard**.

Dimension line dialog

- 1) Draw a dimension line. See “Dimensioning objects” on page 30 for more information.
- 2) Right-click on the dimension line and select **Dimensions** from the context menu to open the Dimension line dialog (Figure 18).
- 3) Make the required changes for dimensioning using the various options in the Dimension line dialog.
- 4) Click **OK** to save the changes and close the Dimension line dialog.

Dimensioning options

The dimensioning options in the Dimensions page in the Graphics Style dialog and the Dimension Line dialog are as follows. The preview in the dialogs changes as the following options are changed showing how the dimension line will appear in a drawing. An example dimension line is shown in Figure 19.

- **Line** – sets the distances between the dimension line and guides with respect to each other, the dimension baseline and the object. The baseline is not visible in a drawing, but is indicated by baseline points on each of the guides.
 - *Line distance* — specifies the distance between the dimension line and the object or the baseline. A minimum of -10mm to a maximum of 10mm can be entered in the text box. The lower the value, the closer the dimension line is to the object or baseline.

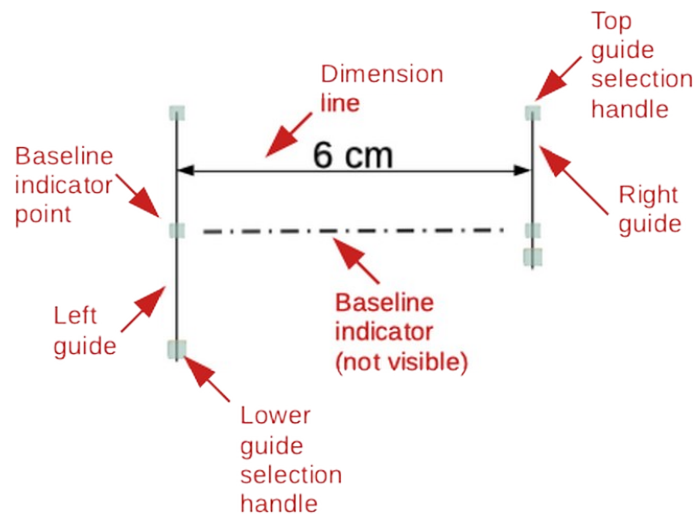

Figure 19: Example dimension line

- *Guide overhang* — is the distance the guide either extends above the dimension line or is below the dimension line. A minimum of -10mm to a maximum of 10mm can be entered in the text box. Positive values cause the guide overhang to extend above the dimension line. Negative values cause the guide overhang to be below the baseline.
- *Guide distance* — specifies the length of the right and left guides below the dimension line toward the object. A minimum of -10mm to a maximum of 10mm can be entered in the text box. Positive values extend the guides above the baseline and further away from the object. Negative values extend the guides below the baseline and closer to the object.
- *Left guide* — specifies the length of the left guide starting at the dimension line. A minimum of -10mm to a maximum of 10mm can be entered in the text box. Positive values extend the guide below the dimension line toward the object. Negative values move the guide away from the object.
- *Right guide* — specifies the length of the right guide starting at the dimension line. A minimum of -10mm to a maximum of 10mm can be entered in the text box. Positive values extend the guide below the dimension line toward the object. Negative values move the guide away from the object.
- *Measure below object* — reverses the positions and lengths of the dimension line and guides set in Line options.
- *Decimal places* — specifies the number of decimal places used for the display of line properties.
- **Legend** – sets the properties of the dimension text.
 - *Text position* — determines the position of the dimension text with respect to the dimension line and the guides. The *AutoVertical* and *AutoHorizontal* checkboxes must be empty before a text position can be assigned.
 - *AutoVertical* — determines the optimal vertical position for the dimension text.
 - *AutoHorizontal* — determines the optimal horizontal position for the dimension text.
 - *Parallel to line* — displays, when selected, the text parallel to the dimension line or, when deselected, at 90 degrees to the dimension line.
 - *Show measurement units* — shows or hides the dimension measurement units. A measurement unit can be selected from the drop-down list.

✓ Note

The dimensioning options are linked and stored with the current work page. All the changes that made apply only to this drawing. New drawings are started with the standard properties of Draw. If the dimensioning options are to be used for future drawings, save the drawing as a template.

Guide selection handles

The guide selection handles at the top and bottom of the guides are used to extend the guides more than the limits of -10mm to 10mm. With reference to the dimension example in Figure 19, the guide selection handles are used as follows:

- **Top guide selection handles** — select either selection handle and drag the handle to increase or decrease the guide overhang of both guides.
- **Lower left guide selection handle** — select the left guide selection and drag the handle to increase or decrease of the left guide distance.
- **Lower right guide selection handle** — select the right guide selection and drag the handle to increase or decrease of the right guide distance.

i Tip

When dimensioning objects, it is recommended to use the zoom function, guide lines and snap functions so dimension lines can be accurately placed on an object. See Chapter 3, Working with Objects and Object Points for more information.

Dimensioning objects

- 1) Click on the triangle ▼ next to the **Lines and Arrows** icon on the Drawing toolbar to open the Lines and Arrows pop-up toolbar (Figure 20).
- 2) Click on **Dimension Line** and the cursor changes to shape, for example to a cross. The shape depends on the computer setup.
- 3) Position the cursor at one corner of the object, then click and drag the cursor to the other corner of the object to draw the dimension line. To restrict drawing the dimension line in the horizontal or vertical direction, press and hold the *Shift* key while dragging the cursor.
- 4) Release the cursor when the other corner of the object is reached and the dimension line is drawn with the dimension automatically added (as shown in Figure 21). The dimension line is also placed automatically on the Dimension Lines layer.
- 5) To edit the text of the dimension, double-click on an unselected dimension line to enter text edit mode and make any necessary changes. Click outside the dimension line to save the changes.
- 6) To configure the dimension line, see “Configuring dimensioning” on page 27.

✓ Note

After editing the dimension text, entering text and then deleting text, save the drawing and reopen it to enable automatic measurements for dimensioning.

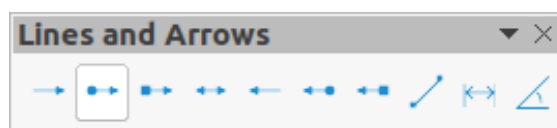

Figure 20: Lines and Arrows sub-toolbar



Figure 21: Example of dimensioning an object

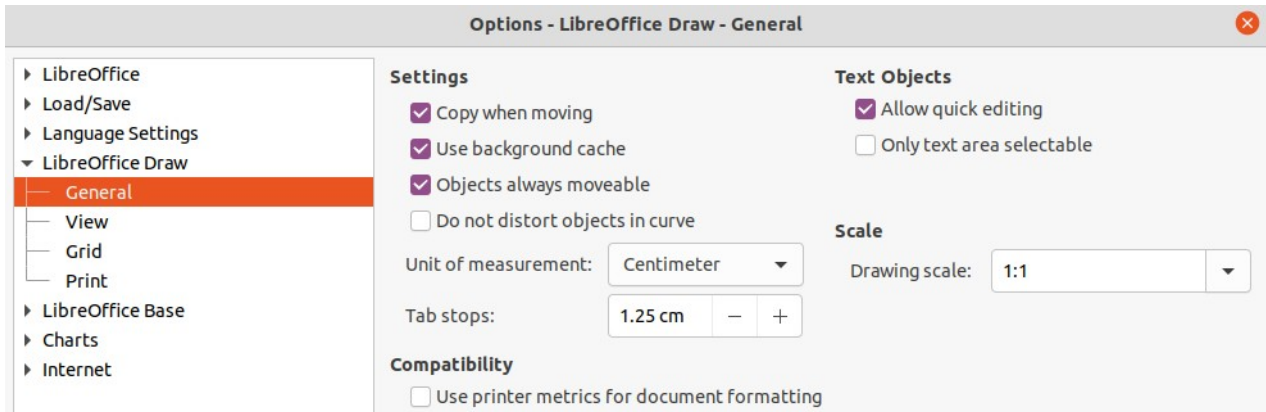

Figure 22: Options LibreOffice Draw General dialog

✓ Note

If drawing to scale, the dimension configuration values in the Graphics Style dialog and the Dimension Line dialog will also be to scale. For example, a value of 10mm in the dialog results in a dimension value of 300mm if the scale has been set to 1:30.

Drawing to scale

In Draw, the predefined drawing area is called the **Workspace** is normally Letter or A4 page size depending on the computer setup and the default printer connected to the computer. However, depending on the actual size of the drawn objects, it is often convenient to reduce or enlarge the drawing by scaling (for example 1:10 or 2:1).

Specify the drawing scale value by going to **Tools > Options > LibreOffice Draw > General** (macOS **LibreOffice > Preferences > LibreOffice Draw > General**) to open the Options dialog (Figure 22) and select a value from the **Drawing scale** drop-down list. The default setting for this option is 1:1. When a change is made to the drawing scale, it is reflected in the rulers at the top and left side of of the **Workspace**.

Any change in the drawing scale has no effect on the basic drawing operations. Draw automatically calculates the necessary values (for example, dimension lines). The spacing of the grid points is independent of drawing scale as the grid is only a visual drawing aid and not a drawing element.

An increase in scale (for example 1:4) allows large objects to be drawn that would not fit into the paper size for a drawing. A decrease in drawing scale (for example 4:1) allows small objects to be drawn accurately at an increased size and make them easier to understand. Examples of drawing to scale are shown in Figure 23 where all three rectangles are the same size in the drawing.

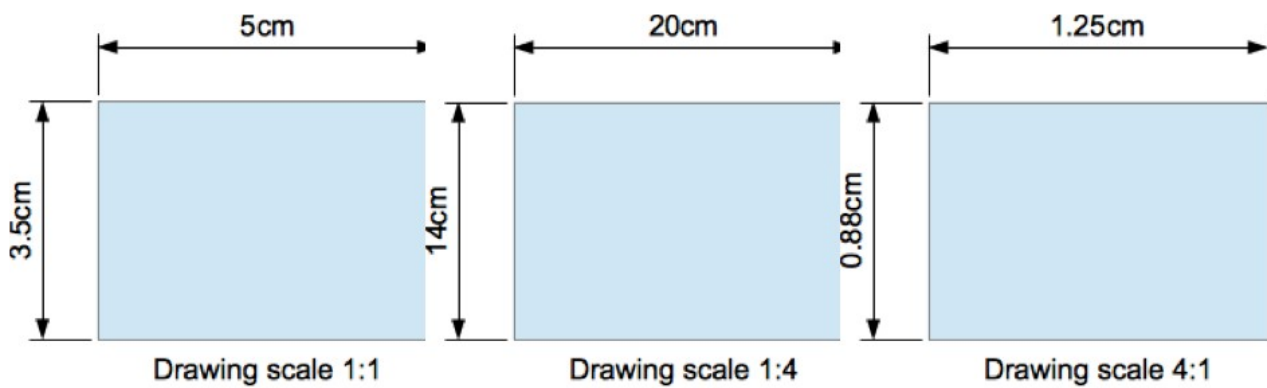

Figure 23: Examples of drawing to scale

- **Left rectangle** – drawn at the default 1:1 scale and dimensioned.
- **Center rectangle** – drawing scale changed to 1:4 and the dimensions were automatically increased by Draw to reflect the decrease in scale.
- **Right rectangle** – drawing scale changed to 4:1 and the dimensions were automatically decreased by Draw to reflect the increase in scale.

Multiple views of a drawing

Several views of the same drawing can be opened and used in LibreOffice Draw. These views are displayed in windows that can use different settings for layers (visible, printable and locked), different zoom levels, different origins, or display different pages of the drawing and even use master page and normal page at the same time. However, make sure that the correct view is active when saving a drawing.

To open a new window showing the drawing, go to **Window > New Window** on the Menu bar. Arrange the windows according to the computer operating system and display preferences. Each window open acts on the same drawing. A change to the drawing in one window is immediately reflected in the other windows.

In each window opened, the filename in the title bar is automatically numbered as shown by the example in Figure 24. If other LibreOffice documents are open at the same time, the list of windows includes all the open documents. The active window has a marker by its filename in the list. Switch between windows by clicking on a name in the list, or by clicking on the window itself if it is visible on the display.

To close a window, go to **Window > Close Window** on the Menu bar, or use the keyboard shortcut *Ctrl+W* (macOS *⌘+W*), or click on **Close** in the Menu bar of the window.

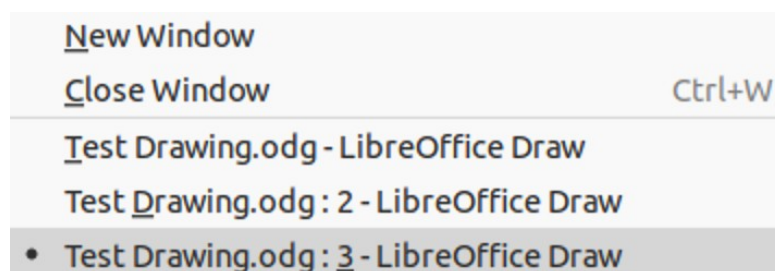

Figure 24: Example of multiple windows

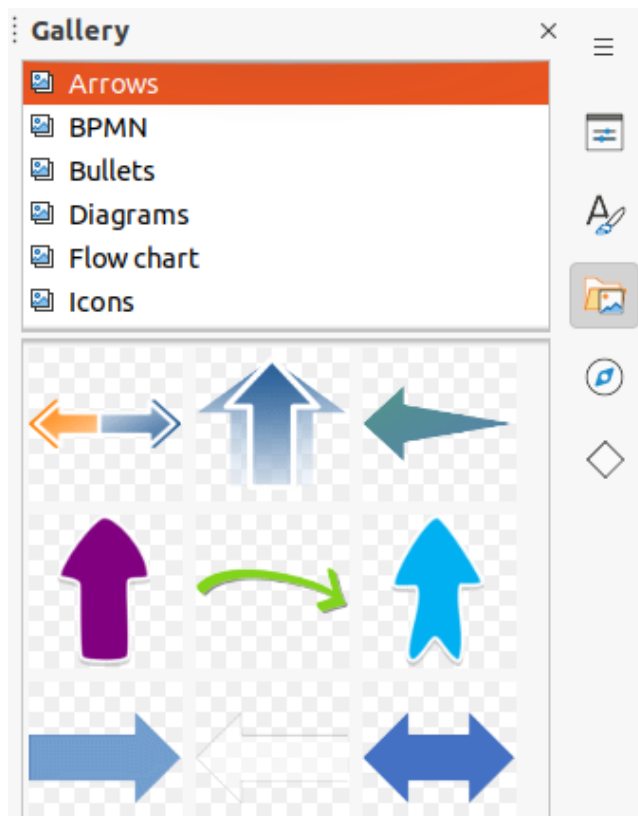

Figure 25: Arrows theme in Gallery deck on Sidebar

Gallery

Draw includes several images in the Gallery. These images are grouped into themes (for example Arrows, Bullets, Diagrams, and so on). The Gallery deck on the Sidebar (Figure 25) lists the available themes. Click on a theme and its images are displayed below the theme list.

- For a detailed view of the images in a gallery theme, click on **Detailed View** at the bottom left of the Sidebar.
- For an icon view of the images in a gallery theme, click on **Icon View** at the bottom left of the Sidebar

Using the Gallery

- 1) Click on **Gallery** on the Sidebar, or go to **Insert > Media > Gallery** on the Menu bar.
- 2) Select a theme from the available options.
- 3) Use one of the following methods to place an image into a drawing:
 - Click on an image in the Gallery deck and drag the image into a drawing.
 - Right-click on an image and select **Insert** from the context menu. The image is placed at the center of a drawing.
 - Right-click on an image and select **Copy** from the context menu. Paste the image into the drawing and the image is placed at the center of the drawing.
- 4) Edit the gallery image to the drawing requirements. For more information on editing images and pictures, see Chapter 6, Editing Pictures.

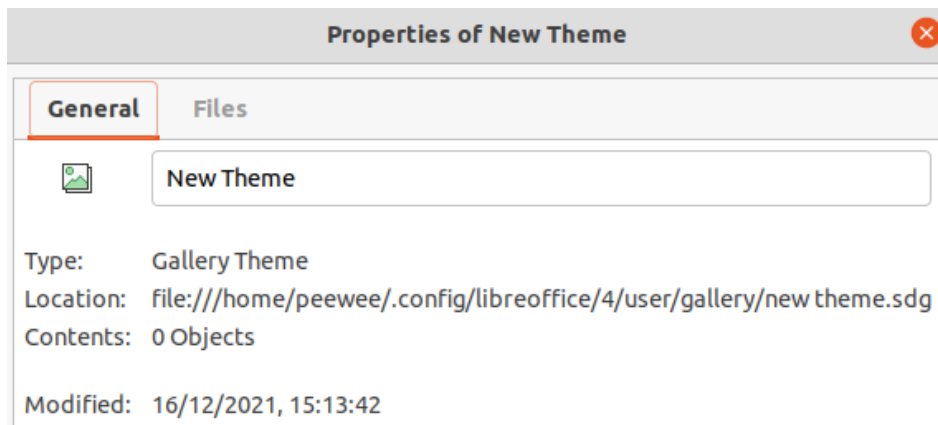

Figure 26: Properties of New Theme dialog - General page

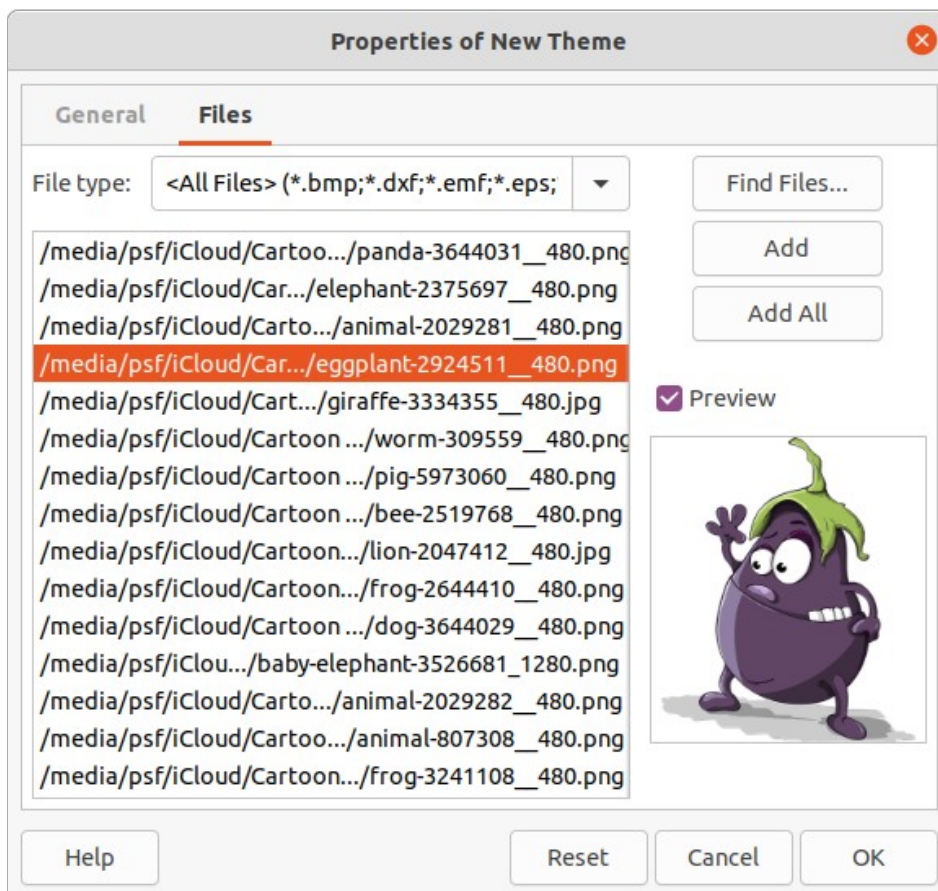

Figure 27: Properties of New Theme dialog - Files page

Creating themes and adding images

- 1) Open the Gallery deck on the Sidebar.
- 2) Click on **New** on the Gallery deck to open the Properties of New Theme dialog (Figure 26).
- 3) Enter a name for the theme in the text box.
- 4) Click on **Files** to open the **Files** page as shown by the example in Figure 27.
- 5) Click on **Find Files** to open a Select Path dialog.
- 6) Browse to the folder that contains the images required and select the folder

- 7) Click **OK** to select the files contained in the folder and the Select Path dialog closes. The list of files contained in the folder now appear in the **Files** page as shown by the example in Figure 27.
- 8) Select the files required for the new theme and click **Add**. The selected files disappear from the file list and the images appear in the Gallery.
- 9) If all the files in the list are to be added, click **Add All**. All the files disappear from the list and the images appear in the Gallery.
- 10) Click **OK** when finished adding files and close the Properties of New Theme dialog. The name of the new theme appears in the Gallery deck.

Note

If a Draw object is added to a theme, the object loses its connection to Draw graphic styles and all properties are set as direct formatting.

Deleting gallery themes and images

- 1) Right-click on a theme or image in the Gallery and select **Delete** from the context menu.
- 2) Click **Yes** in the confirmation dialog and the image or theme is deleted from the Gallery.

Note

Only themes and images that have added to Draw can be deleted. The themes and images that were included with the installation of LibreOffice cannot be deleted.

Note

An image is a linked file and only the link is deleted from the Gallery. The original image file is not deleted.

Updating the Gallery

All images in the Gallery are linked files. Occasionally, it is beneficial to update a theme that has been added to Draw to make sure that all files are still accessible. Right-click on a theme that has at least one file added to the theme and select **Update** from the context menu.

Renaming themes

To rename a theme that has been added to Draw, right-click on the theme name and select **Rename** from the context menu.

Note

Only themes and images that have added to Draw can be renamed. The themes and images that were included with the installation of LibreOffice cannot be renamed.

Colors

Draw (like all LibreOffice components) uses colors grouped into color palettes. Colors can be created to suit drawing requirements. All custom colors created are placed in the custom color palette. The following explains the color models that can be used to create a custom color.

- **RGB** — stands for Red, Green, Blue. The RGB color model is based on the additive color model of light waves and is designed for electronic displays and computers. This means, the more color added, the closer a color moves towards white. RGB is created using scales from 0 to 255. This means that black is when R=0, G=0, and B=0 and white is when R=255, G=255, and B=255. LibreOffice uses the RGB color model internally for printing in all of its software modules.
- **CMYK** — stands for Cyan, Magenta, Yellow, Key (Black). It is a subtractive color model where colors are subtracted to get to white. It is mainly used in printing, which is why the ink cartridges for a printer are labeled CMYK. CMYK works on a scale of 0 to 100. If C=100, M=100, Y=100, and K=100, the color produced is black. If C=0, M=0, Y=0, and K=0, the color produced is white.
- **HSB** — stands for Hue, Saturation, Brightness. HSB values are an alternative representation of the RGB color model and was designed to be more closely aligned with the way human vision perceives color-making attributes. Use HSB values to fine tune any custom colors that are created.

Tip

More information on color models and color values can be found at https://en.wikipedia.org/wiki/Color_model.

Changing colors

When changing colors in objects, color palettes are used to select colors. These color palettes are installed with LibreOffice and are used in all the LibreOffice modules. Using these color palettes is similar across all types of objects, but accessing the color palettes does vary according to the type of object selected.

Color Bar

Although LibreOffice includes tools to precisely specify a color, it also includes a Color Bar (Figure 28) that allows the area fill, border, or line color of an object to be quickly changed in a drawing.

- 1) Select an object in the drawing.
- 2) Go to **View > Color Bar** on the Menu bar to open the Color Bar. When the Color Bar opens, it is labeled Color Palette.
- 3) Left click on a color to change the area fill color or right-click on a color to change the border or line color of a selected object.

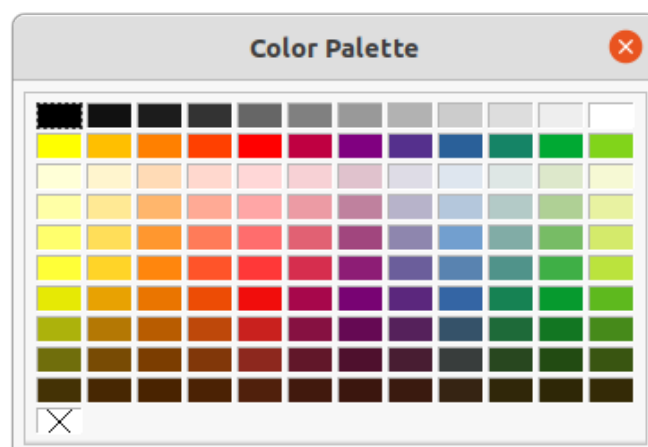

Figure 28: Color Bar (Color Palette)

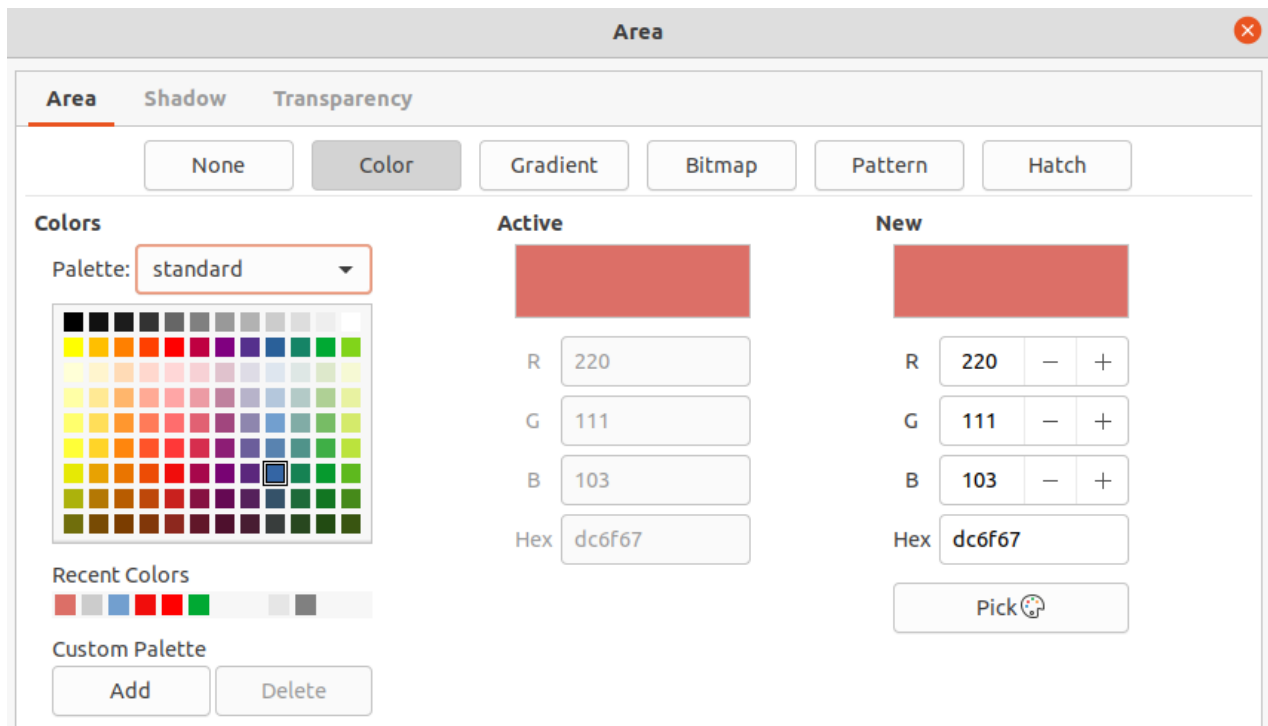

Figure 29: Area dialog - Area Color page

- 4) Left click on the X box in the bottom left corner of the Color Bar to remove the color from an object fill, or right-click on the X box in the bottom left corner of the Color Bar to remove the color from an object border,
- 5) To close the Color Bar, go to **View > Color Bar** on the Menu bar and deselect Color Bar.

✓ Note

The colors available in the Color Bar are from the **Standard** color palette that is part of the LibreOffice installation.

Area dialog

- 1) Select an object in the drawing.
- 2) Open the Area dialog (Figure 29) using one of the following methods:
 - Go to **Format > Area** on the Menu bar.
 - Right-click on the object and select **Area** from the context menu.
- 3) Click on **Area**, then click on **Color** to open the **Color** page.
- 4) In **Colors**, select a color palette from the *Palette* drop-down list.
- 5) Click on a color from the ones displayed in the color palette, or select a color that has been previously used from *Recent Colors*.
- 6) Click **OK** to save the changes and close the Area dialog. The selected fill color appears in the selected object.

Area panel on the Sidebar

- 1) Select an object in the drawing.
- 2) Open the **Area** panel in the Properties deck on the Sidebar (Figure 30).
- 3) Select *Color* from the **Fill:** drop-down list.
- 4) Click on the triangle ▼ on the right of **Fill Color** to open the palette last used.

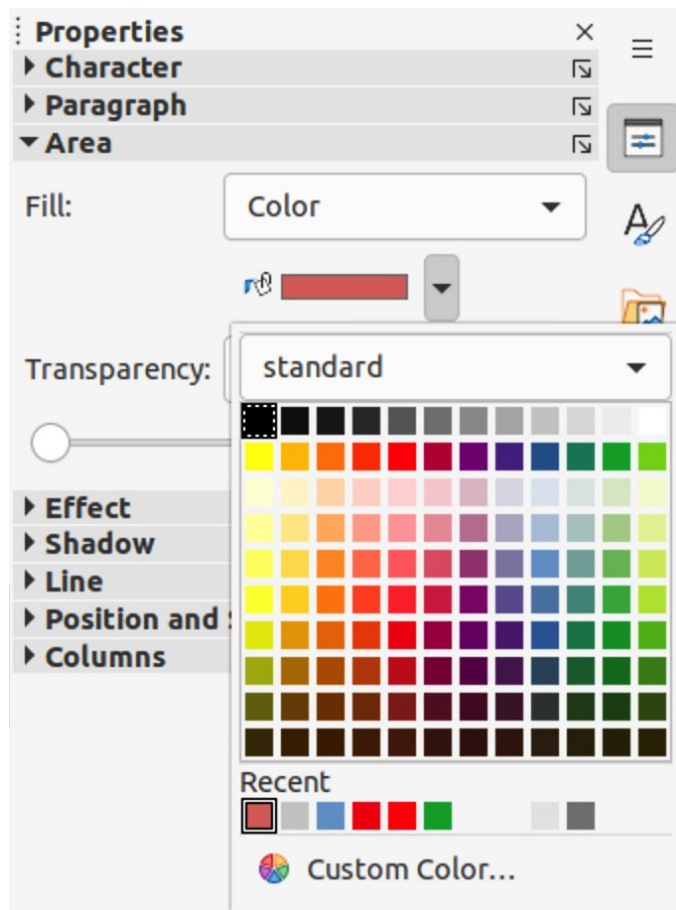

Figure 30: Area panel in Properties deck on Sidebar

- 5) Select a color palette to use from the available palettes in the drop-down list.
- 6) Click on a color from the colors displayed in the color palette, or select a color that has been previously used from those displayed in *Recent*. The color palette closes and the selected fill color is applied to the object.

Fill Color on the Line and Filling or Drawing toolbars

- 1) Select an object in the drawing.
- 2) Click on the triangle ▼ to the right of **Fill Color** on the Line and Filling or Draw toolbar to open the last color palette used.
- 3) Select a color palette to use from the *Line Color* drop-down list.
- 4) Click on a color from the colors displayed in the color palette, or select a color that has been previously used from those displayed in *Recent*. The color palette closes and the selected fill color is applied to the selected line.

Line dialog

- 1) Select a line or an object in the drawing.
- 2) Open the Line dialog (Figure 31) using one of the following methods:
 - Go to **Format > Line** on the Menu bar.
 - Right-click on the line or object and select **Line** from the context menu.
- 3) Click on **Line** to open the **Line** page.
- 4) Click on the triangle ▼ to the right of **Color** to open the last color palette used.
- 5) Select a color palette to use from the available palettes in the drop-down list.

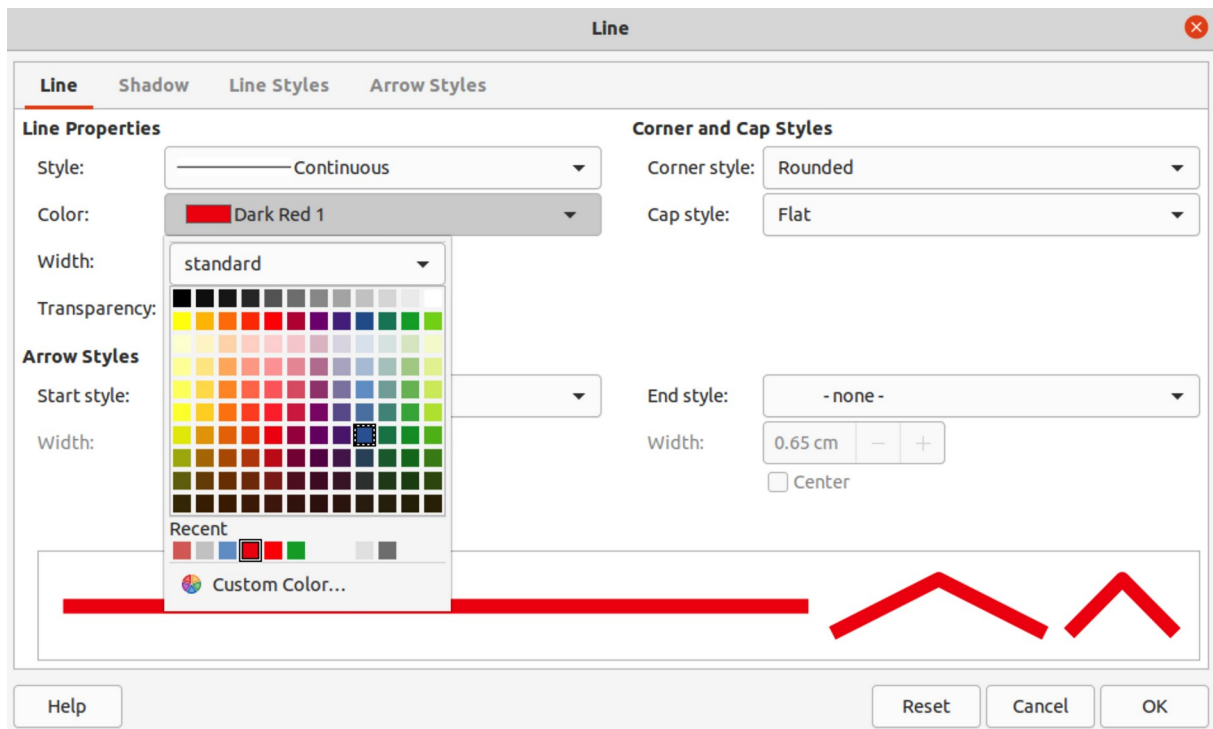

Figure 31: Line dialog - Line page - Color

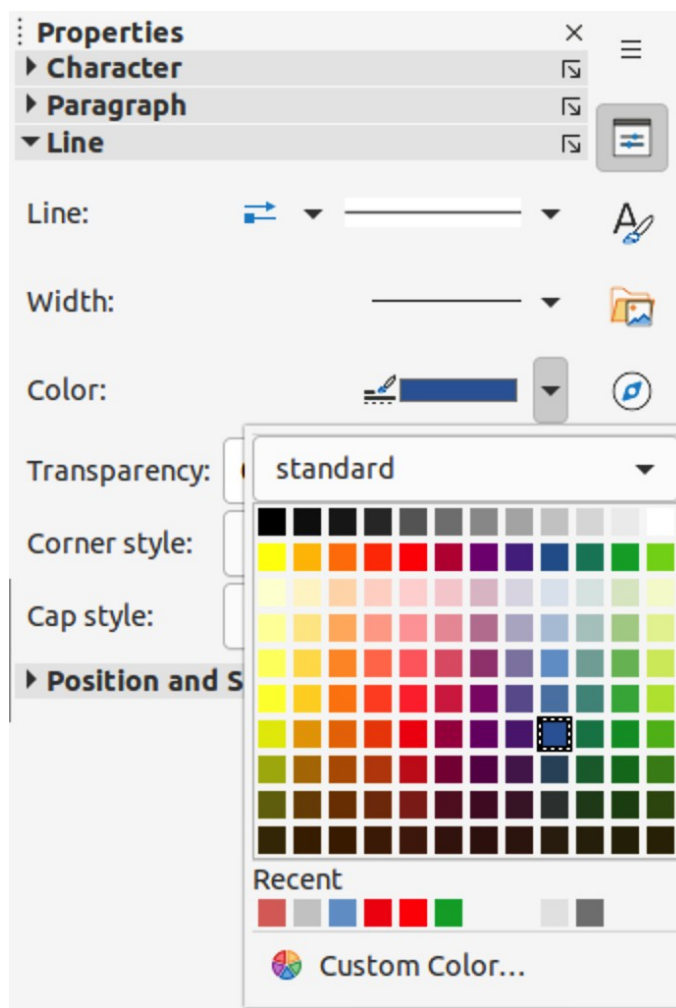

Figure 32: Line panel in Properties deck on Sidebar

- 6) Click on a color from the colors displayed in the color palette, or select a color that has been previously used from those displayed in *Recent*. The color palette closes and the selected line color is applied to the line or object border.
- 7) Click **OK** to save the color change and close the Line dialog.

Line panel on the Sidebar

- 1) Select a line or an object in the drawing.
- 2) Open the *Line* panel in the Properties deck on the Sidebar (Figure 32).
- 3) Click on the triangle ▼ to the right of **Color** to open the palette last used.
- 4) Select a color palette to use from the available palettes in the drop-down list.
- 5) Click on a color from the colors displayed in the color palette, or select a color that has been previously used from those displayed in *Recent*. The color palette closes and the selected line color is applied to the line or object border.

Line Color on the Line and Filling or Drawing toolbars

- 1) Select a line or object in the drawing.
- 2) Click on the triangle ▼ to the right of **Line Color** on the Line and Filling or Draw toolbar to open the last color palette used.
- 3) Select a color palette to use from the available palettes in the drop-down list.
- 4) Click on a color from the colors displayed in the color palette, or select a color that has been previously used from those displayed in *Recent*. The color palette closes and the selected line color is applied to the line or object border.

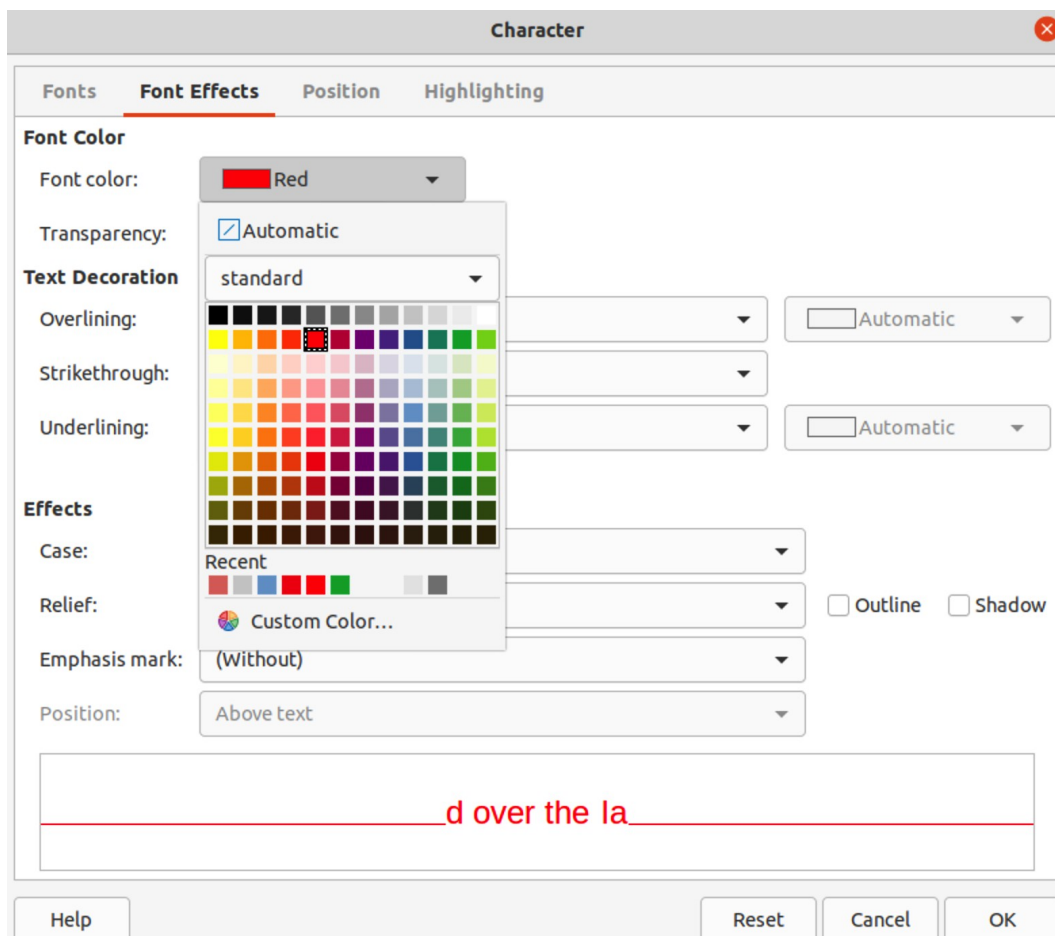

Figure 33: Character dialog - Font Effects page - Color

Changing text color

Changing text color is very similar to changing the color of an area fill, object border, or line. The Text Formatting toolbar automatically opens and replaces the Line and Filling toolbar when text is selected in a drawing. If the Text Formatting toolbar does not appear, go to **View > Toolbars** on the Menu bar and select **Text Formatting**.

Character dialog

- 1) Select the text in a text box or object and make sure the text is highlighted.
- 2) Open the Character dialog (Figure 33) using one of the following methods:
 - Go to **Format > Character** on the Menu bar.
 - Right-click on the highlighted text and select **Character** from the context menu.
- 3) Click on **Font Effects** to open the **Font Effects** page.
- 4) Click on the triangle ▼ to the right of **Font Color** to open the last color palette used.
- 5) Select a color palette to use from the available palettes in the drop-down list.
- 6) Click on a color from the colors displayed in the color palette, or select a color that has been previously used from those displayed in *Recent*. The color palette closes and the selected color is applied to the selected text.
- 7) Click **OK** to save the color change and close the Character dialog.

Character panel on the Sidebar

- 1) Select the text in a text box or object and make sure the text is highlighted.

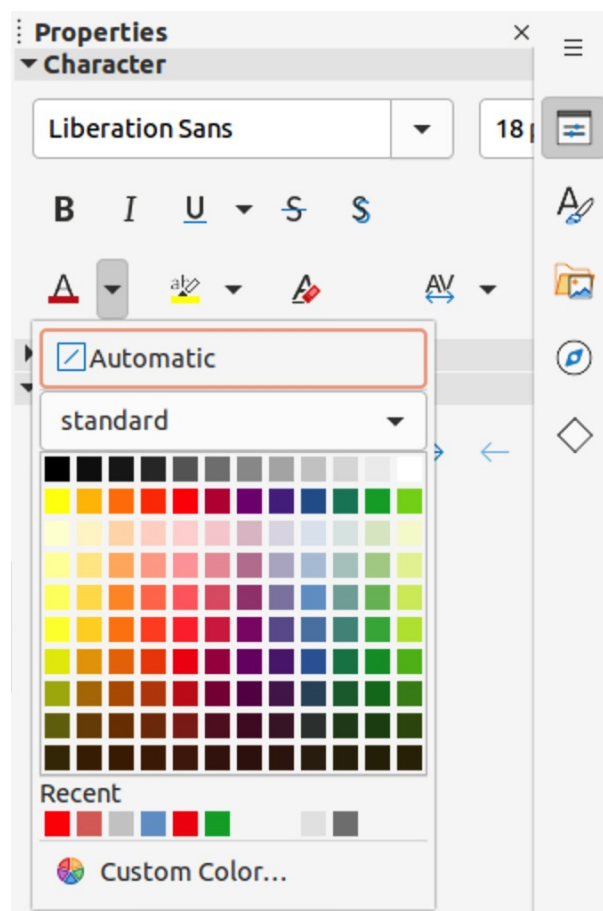

Figure 34: Character panel in Properties deck on Sidebar

- 2) Open the *Character* panel in the Properties deck on the Sidebar (Figure 34).
- 3) Click on the triangle ▼ to the right of **Font Color** to open the color palette last used.
- 4) Select a color palette to use from the available palettes in the drop-down list.
- 5) Click on a color from the colors displayed in the color palette, or select a color that has been previously used from those displayed in *Recent*. The color palette closes and the selected color is applied to the selected text.

Creating colors

Using *Pick a Color* dialog

- 1) Select the object or text and open the *Pick a Color* dialog (Figure 35) using one of the following methods:
 - Open the *Area* dialog, then click on **Color** to open the **Color** page and click on **Pick**.
 - Open the *Area* section in Properties deck on the Sidebar, click on the triangle ▼ to the right of **Fill Color** to open the color palette and click on **Custom Color** at the bottom of the color palette.
 - Open the *Line* dialog, then open a color palette in **Color** and click on **Custom Color** at the bottom of the color palette.
 - Open the *Line* section in Properties deck on the Sidebar, click on the triangle ▼ to the right of **Line Color** to open the color palette and click on **Custom Color** at the bottom of the color palette.
 - Open the *Character* dialog, then open a color palette in **Font color** and click on **Custom Color** at the bottom of the color palette.

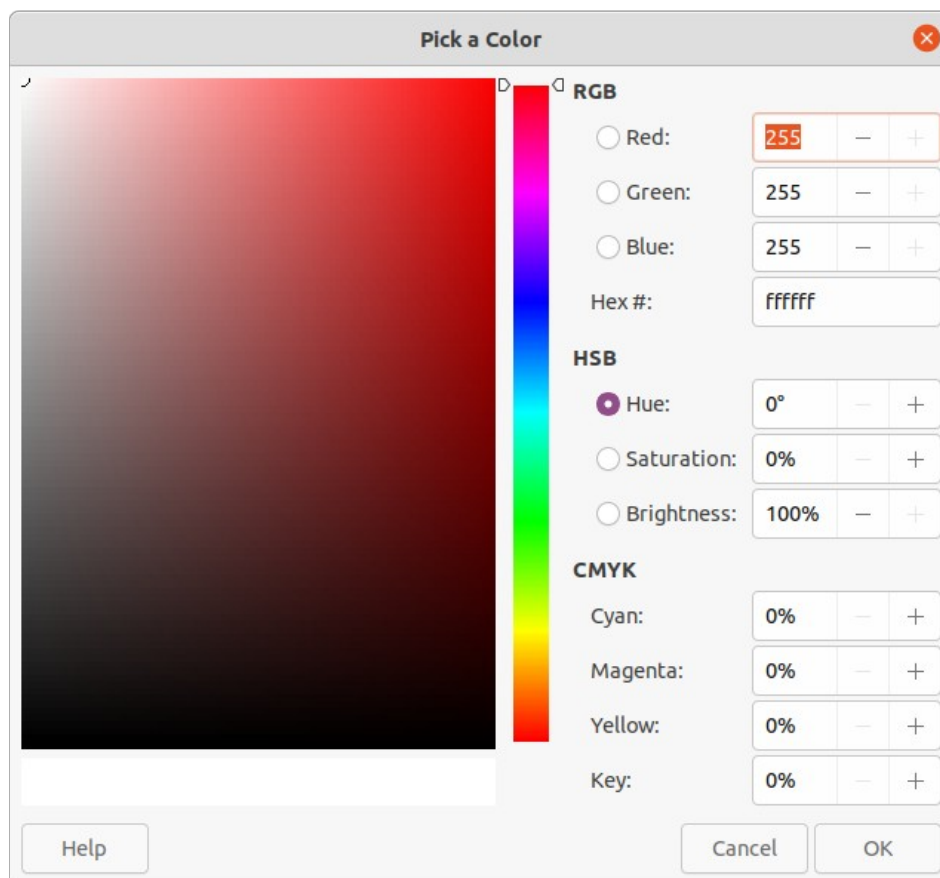

Figure 35: *Pick a Color* dialog

- Open the **Character** panel in Properties deck on the Sidebar, click on the triangle ▼ to the right of **Font Color** to open the color palette and click on **Custom Color** at the bottom of the color palette.
- 2) Select a color range in the vertical color bar on in the Pick a Color that approximately matches the custom color being created.
- 3) Click and drag the small target circle in the color box until the color matches the custom color required. The values for RGB, HSB and CMYK change as the small target circle is dragged around the color box. This helps in creating the exact color if these color values are known.
- 4) Alternatively, if the color values or hex number are known, enter these values in the appropriate text box. The values in all the text boxes changes to match the new values. For example, enter HSB values, the RGB, CMYK and Hex values also change to match.
- 5) Click **OK** to save the changes and close the Pick a Color dialog.

✓ Note

When using the Line or Character dialog to open the Pick a Color dialog, the custom color created cannot be saved into the Custom color palette or renamed with a more meaningful name. The custom color created is named using the hex value that is displayed in the Pick a Color dialog. Only the Area dialog has the ability to rename custom colors and save custom colors into the Custom palette.

✓ Note

LibreOffice uses the RGB color model for printing in color. The RGB values of a selected color are displayed below the preview boxes.

Using Area dialog

- 1) Open the Area dialog and click on **Color** to open the **Color** page.
- 2) In **New**, enter the RGB values or, if known, the Hex value into the text boxes. The color changes in the preview box to match the values entered.
- 3) Alternatively, in **New**, use the minus and plus signs for the RGB values to decrease or increase the values. The color changes in the preview box to match the values entered.
- 4) Click **OK** to change the color and close the Area dialog.

Adding custom colors

If necessary, add a custom color to the **Custom** color palette using the Area dialog as follows:

- 1) Make sure the Area dialog is open at the **Color** page.
- 2) Select the custom color that is displayed in *Recent Colors*.
- 3) Click on **Add** to open a Name dialog.
- 4) Enter a new name for the color in the text box.
- 5) Click **OK** to save the changes and close the Name dialog. The custom color appears in the *Custom* palette.
- 6) Click **OK** to close the Area dialog.

Renaming custom colors

Only a custom color can be renamed using the Area dialog as follows:

- 1) Make sure the Area dialog is open at the **Color** page.

- 2) Select the custom color that is displayed in the *Custom* color palette.
- 3) Click on **Add** to open a Name dialog.
- 4) Enter a new name for the color in the text box,
- 5) Click **OK** to save the changes and close the Name dialog. The custom color appears in the *Custom* palette.
- 6) Click **OK** to close the Area dialog.

✓ Note

Renaming a custom color does not actually rename the custom color, but adds the custom color to the *Custom* palette with a new name.

✓ Note

It is important to use a memorable names for custom colors so that they can be easily recognized in the *Custom* palette. By default, a custom color is given a hex number, which makes it difficult identifying colors when there is more than one custom color.

Deleting custom colors

Only a custom color can be deleted using the Area dialog as follows:

- 1) Make sure the Area dialog is open at the **Color** page.
- 2) Select the custom color that is displayed in the *Custom* color palette.
- 3) Click on **Delete**. There is no confirmation given when deleting custom colors.
- 4) Click **OK** to close the Area dialog.

Bézier curves

In LibreOffice, Bézier¹ curves can be used in a drawing. A curve is defined by means of a start point, an end point, and, where necessary, control points. For points on the curve the terms nodes or anchors are often used. For more information and an explanation of the mathematical background of Bézier curves, see https://en.wikipedia.org/wiki/Bézier_curve.

Bézier curves are very useful for experimenting with the shape and form of curves. In point mode the curve alignment can be changed by dragging the points with the cursor. In the example shown in Figure 36, the curve leaves the start point P0 in the direction of the first control point P1 and arrives at the end point P3 from the direction of the second control point P2. The more distant a control point is from the start or end point, the smaller the curvature at that point.

Drawing Bézier curves

- 1) Click on **Curve** in the **Curves and Polygons** panel in the Shapes deck on the Sidebar or in the Drawing toolbar.
- 2) Click at the start point for the curve and drag the cursor to the approximate position of the end point for the curve.
- 3) Release the cursor and drag the end point of the curve to its end position.
- 4) Double-click when the end position of the curve is reached and a curve is drawn. The arc of the curve is determined by the distance dragged to create the end point.

1 Bézier curves were invented by Pierre Bézier, an engineer working with the Renault car manufacturer, who developed the technique in the 1960s. The technology was intended to make modeling the surface of vehicles easier.

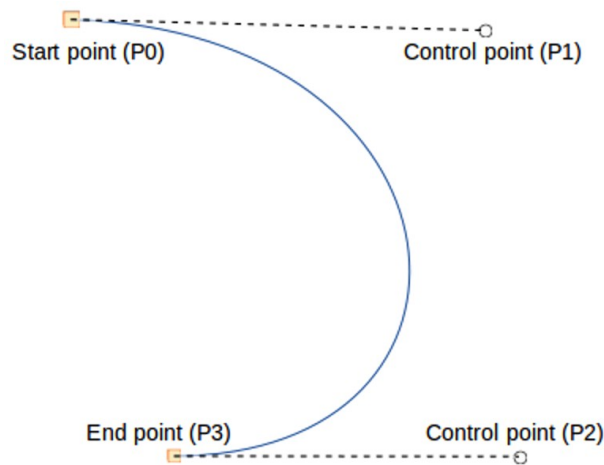

Figure 36: Example of a Bézier curve



Figure 37: Edit Points toolbar

- 5) Switch to points mode using one of the following methods:
 - Go to **Edit > Points** on the Menu bar.
 - Click on **Points** on the Standard toolbar.
 - Use the keyboard shortcut *F8*.
- 6) Open the Edit Points toolbar (Figure 37) using one of the following methods. The Edit Points toolbar does not become visible until a point has been selected on a curve.
 - Go to **View > Toolbars** on the Menu bar and select **Edit Points**.
 - Click on **Points** on the Standard toolbar.
 - Use the keyboard shortcut *F8*.
 - If added to the toolbar, click on **Points** on the Drawing toolbar.
- 7) Click once on the curve to display the start and end points. The start point of the curve is larger than the end point.
- 8) Click on a start or end point to display the control points. Control points appear at the end of a dashed line connected to the selected point, as shown in Figure 36.
- 9) Click on the control point and drag it to a new position to change the shape of the curve.
- 10) When the shape of the curve is correct, release the mouse button to fix the curve.
- 11) Click anywhere on the workspace to deselect the curve and stop editing points.

Edit Points tools

After the initial opening of the Edit Points toolbar, when an object is selected that has been converted to a curve or polygon, the toolbar is displayed. The tools available on the Edit Points toolbar allow the editing of a Bézier curve and changing of the curve shape. A point on a Bézier curve has to be selected for all the tools on the Edit Points toolbar to become available.

- **Move Points** — click and drag on a point to move it to another location.
 - The curve on both sides of the point follows the movement and changes shape as the selected point changes position.

- Click and drag on the curve between points to move the entire curve without distorting the form.
- **Insert Points** — activates the insert mode when selected and inserts smooth points onto a curve. Insert mode remains active after inserting points. Select **Move Points** to deactivate insert mode.
 - The inserted point can be moved while insert mode is activated.
 - If a corner or symmetrical point is required, insert a smooth point first and convert the point to a corner or symmetrical point.
- **Delete Points** — deletes selected points. If several points are to be deleted, hold down the *Shift* key whilst selecting points and before clicking on **Delete Points**.
- **Convert To Curve** — converts a curve into a straight line or a straight line into a curve as shown in Figure 38.
 - Select a single point and the curved segment after the point converts to a straight line, or converts a straight line segment to a curve after the point.
 - When converting a segment from a curve to a straight line, each point at each end of the segment becomes a control point similar to the start or end point.
 - When converting a segment from a straight line to a curve, each control point at each end of the segment becomes a smooth point.



Figure 38: Example of converting a curved segment to a line

- **Close Bézier** — closes a freeform line or curve by connecting the start point with the end point creating an object with area fill.
- **Split Curve** — splits a curve into two or more curves. Select a point or points and click on **Split Curve** to create separate segments of a curve. Deselect the curve, then select a segment to move or edit it.
- **Corner Point** — converts a selected point into a corner point, as shown in Figure 39. Corner points have two movable control points, which are independent from each other, and allows a corner to be created in a curve.

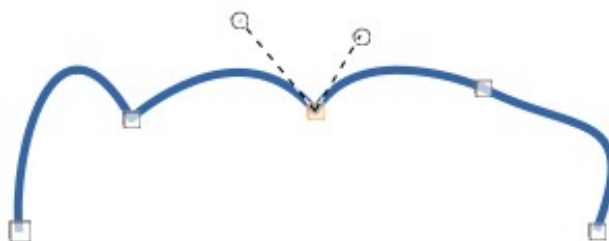

Figure 39: Example of a corner point

- **Smooth Transition** — converts a corner or symmetrical point into a smooth point, as shown in Figure 40. Both control points of a smooth transition point are aligned in parallel and can only be moved simultaneously. The control points may differ in length, allowing the degree of curvature to be varied.

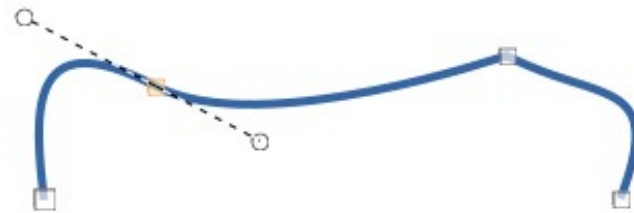

Figure 40: Example of a smooth transition point

- **Symmetric Transition** — converts a corner point or a smooth point into a symmetrical point, as shown in Figure 41. Both control points of a symmetrical transition point are aligned in parallel and have the same length. These control points can only be moved simultaneously and the degree of curvature is the same in both directions.



Figure 41: Example of a symmetrical transition point

- **Eliminate Points** – allows selection of several points before using the **Delete Points** tool. This is useful when deleting a straight line segment to create a complete curve.

Adding comments to a drawing

Draw supports comments similar to those in Writer and Calc. For more about adding, navigating, and replying to comments, see the *Getting Started Guide* for more information. Comments in Draw cannot be printed. To reply to a comment in Draw, a new comment has to be added.

- 1) Go to **Insert > Comment** on the Menu bar and a comment box (Figure 42) appears in the upper left-hand corner of a drawing. Draw automatically adds the user name and date at the bottom of the comment and places a comment marker on the drawing page.
- 2) Type or paste a comment into the comment text box.
- 3) To apply basic formatting to the text, right-click on the text and select the formatting option from the context menu.
- 4) To delete a comment, use one of the following methods:
 - Right-click in the comment box and select a delete option from the context menu.
 - Right-click on the comment marker and select a delete option from the context menu.
 - Click on the triangle ▼ in the bottom right of the comment box and select a delete option from the context menu.
- 5) To move a comment, click on the comment marker and drag it to a new position.
- 6) To hide comments, use one of the following methods:
 - Go to **View** on the Menu bar and deselect **Comments** to hide the comment and the comment marker.
 - Click on the drawing outside of the comment to hide the comment. The comment marker remains visible.
- 7) To show comments, go to **View > Comments** on the Menu bar and click on the comment marker.

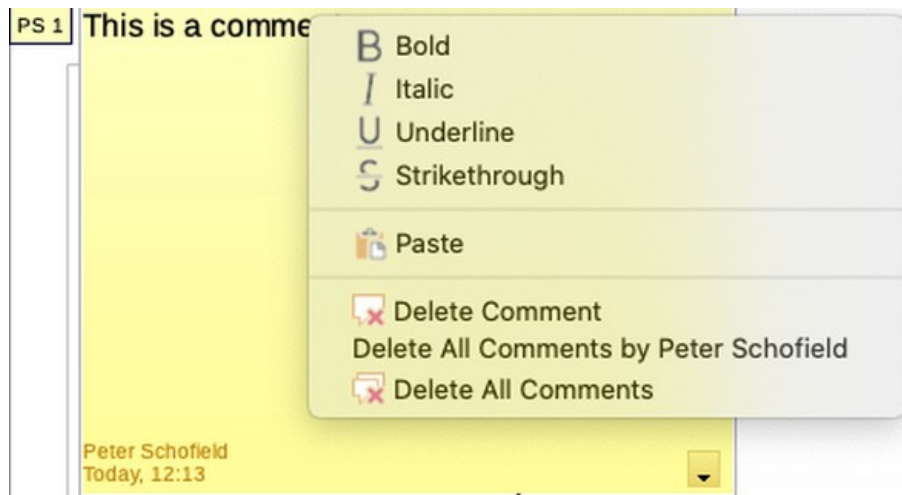

Figure 42: Comments in Draw

✓ Note

For the user name and initials to appear in a comment, enter the user data in **Tools > Options > LibreOffice > User Data** dialog (macOS **LibreOffice > Preferences > LibreOffice > User Data**). If more than one person edits the document, each author is automatically allocated a different background color.

Coordinate system

X and Y axes

The x-axis is the horizontal position of an object and the y-axis is the vertical position of an object. The rulers do not show a minus sign if there are negative coordinates. However, the minus sign for negative coordinates is shown in the position field in the **Status Bar** and the Position and Size dialog.

Workspace

The **Workspace** in Draw is larger than the drawing page. The area outside the drawing page is one page width right and left and a half page above and below the drawing page. The size of the drawing page is indicated by highlighted portions in the horizontal and vertical rulers.

Draw objects can be drawn partly or wholly outside the drawing page and these objects are saved with the drawing. However, when the drawing is printed or exported, any object or portion of an object not on the drawing page is not included. This allows the **Workspace** area around the drawing page to be used for drafts when creating objects.

Object position

The coordinates of objects and snap guides are shown relative to the origin. The default origin for coordinates (0.00/0.00 position) is the top-left corner of the drawing page without margins or the top left corner of the drawing page where the margins intersect. To change the default origin, click and drag the intersection of the rulers in the top left corner of the **Workspace** to the desired position. Guide lines appear as the intersection is dragged from its default origin to its new position. This origin setting is only for the current view and is not saved in the document.

The area inside the default origin is the area used for the grid when the option **Snap to Grid** and **Display Grid** are selected.

To reset the default origin back to its original setting at the top-left corner of the page, double-click in the top-left corner on the **Workspace** where the horizontal and vertical rulers meet.

Accuracy

Draw internally uses integer values in 1/100 mm. Therefore, for example, it is not possible to get an exact position for 1/8 inch. Also, many dialog fields are restricted to two decimals.

To work with the maximum possible accuracy, go to **Tools > Options > LibreOffice Draw > General** (macOS **LibreOffice > Preferences > LibreOffice Draw > General**) and set the option **Unit of measurement** to *Millimeter*. The rulers will show metric units after this option has been selected. To use another measurement unit for the rulers, right-click on a ruler and select the measurement unit from the context menu. The horizontal and vertical rulers can have different measurement units.