

LibreOffice
The Document Foundation

Draw Guide

Chapter 4
Changing Object Attributes

Copyright

This document is Copyright © 2005–2011 by its contributors as listed below. You may distribute it and/or modify it under the terms of either the GNU General Public License (<http://www.gnu.org/licenses/gpl.html>), version 3 or later, or the Creative Commons Attribution License (<http://creativecommons.org/licenses/by/3.0/>), version 3.0 or later.

All trademarks within this guide belong to their legitimate owners.

Contributors

John Cleland

Martin Fox

Jean Hollis Weber

Feedback

Please direct any comments or suggestions about this document to:

documentation@global.libreoffice.org

Acknowledgments

This chapter is based on an original French document written for OpenOffice.org 1.x by Michel Pinquier (translated into English by Alex Thurgood) and previous content revised by Jim Taylor. The chapter was revised for OpenOffice.org 2.0 by Linda Worthington, Daniel Carrera, Jean Hollis Weber, and Agnes Belzunce, and later translated into German by Wolfgang Uhlig. The German revisions were then translated into English and revised for OpenOffice.org 3.3 and LibreOffice 3.3 by Martin Fox. Other contributors included Peter Hillier-Brook, Hazel Russman, Gary Schnabl, and Claire Wood.

Publication date and software version

Published 3 July 2011. Based on LibreOffice 3.3.3.

Note for Mac users

Some keystrokes and menu items are different on a Mac from those used in Windows and Linux. The table below gives some common substitutions for the instructions in this chapter. For a more detailed list, see the application Help.

<i>Windows/Linux</i>	<i>Mac equivalent</i>	<i>Effect</i>
Tools > Options menu selection	LibreOffice > Preferences	Access setup options
Right-click	Control+click	Open context menu
Ctrl (Control)	⌘ (<i>Command</i>)	Used with other keys
F5	Shift+⌘+F5	Open the Navigator
F11	⌘+T	Open Styles and Formatting window



Contents

Copyright.....	2
Note for Mac users.....	2
Toolbars and menus.....	4
Line and Filling toolbar.....	4
Text Formatting toolbar.....	4
The context menu.....	4
Editing lines and borders.....	5
Common line properties.....	6
Drawing arrows.....	7
Line shadows.....	8
Customizing line and arrow styles.....	8
Customizing line styles.....	8
Customizing arrow styles.....	9
Editing the inside (fill) of an object.....	11
Common fill properties.....	11
Fill with a uniform color.....	11
Fill with a gradient.....	12
Fill with a line pattern.....	12
Fill with an image.....	12
Adding a shadow to an area.....	13
Advanced area fill options.....	13
Creating your own fill color.....	13
Creating your own gradient.....	14
Creating your own hatching (line pattern).....	15
Creating your own bitmap fill.....	16
Customizing shadows.....	17
Adding transparency.....	18
Using styles.....	19
Creating a new style.....	19
Applying a style.....	19
Modifying a style.....	20
Special effects.....	20
Rotating an object.....	20
Flip an object.....	20
Mirror copies.....	21
Distorting an image.....	21
Distort an object.....	22
Set in circle (perspective).....	22
Set to circle (slant).....	23
Dynamic gradients.....	23

Toolbars and menus

To change an object's attributes (such as color or border width) you can use the Line and Filling toolbar, the Text Formatting toolbar, or the context menu.

Line and Filling toolbar

If the Line and Filling toolbar is not visible, you can display it using **View > Toolbars > Line and Filling**. From here you can edit the most common object attributes. You can also open the Line dialog by clicking on the Line  icon and the Area dialog by clicking on the Area  icon to see more options.

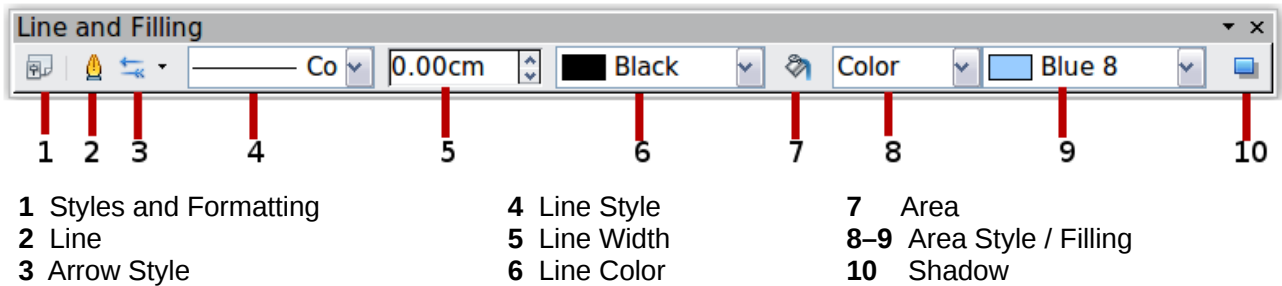

Figure 1: Line and Filling toolbar

Text Formatting toolbar

When you select text, the Line and Filling toolbar changes to show text formatting options. You can also display the Text Formatting toolbar by choosing **View > Toolbars > Text Formatting**.

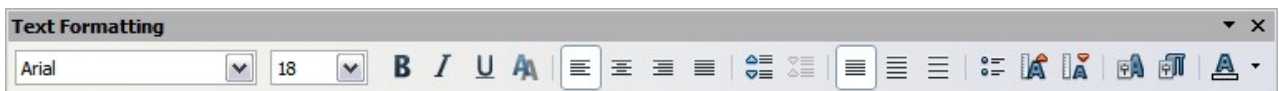

Figure 2: Text Formatting toolbar (when text is selected)

The context menu

When an object is selected, you can right-click on the object to open a context menu (Figure 3). The context menu provides additional access to the options shown above and another way to change an object's attributes. The entries with a small arrow on the right-hand side contain a submenu.

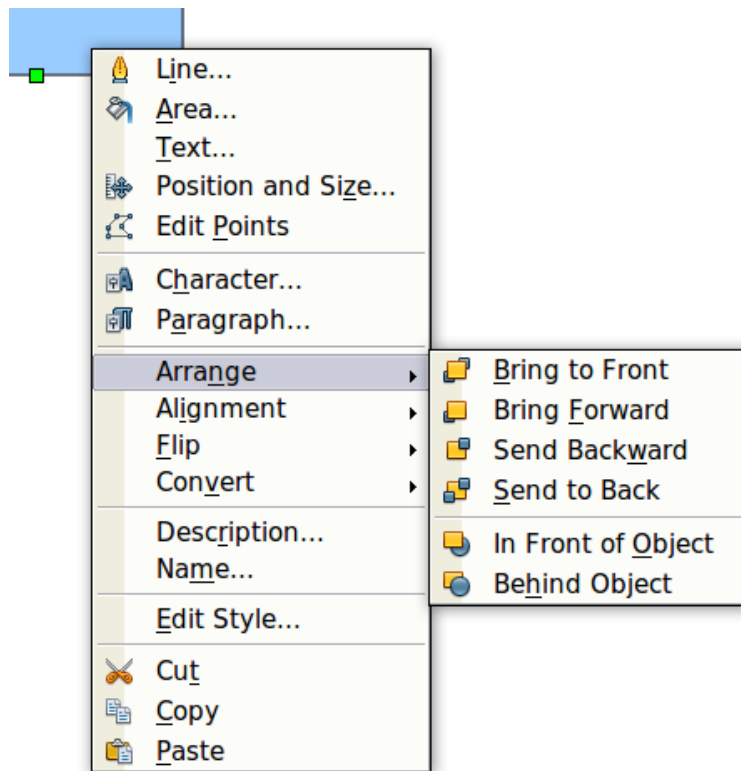

Figure 3: Right-click on an object to see the context menu

Editing lines and borders

Lines, arrows, and the borders of an object are managed through the same dialog (Figure 5).

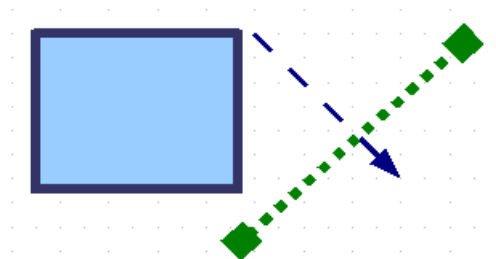

Figure 4: Lines and borders

You can change some properties from the **Line and Filling** toolbar. To see more options, select the object and right-click on the object and choose **Line** from the context menu. This opens the Line dialog.

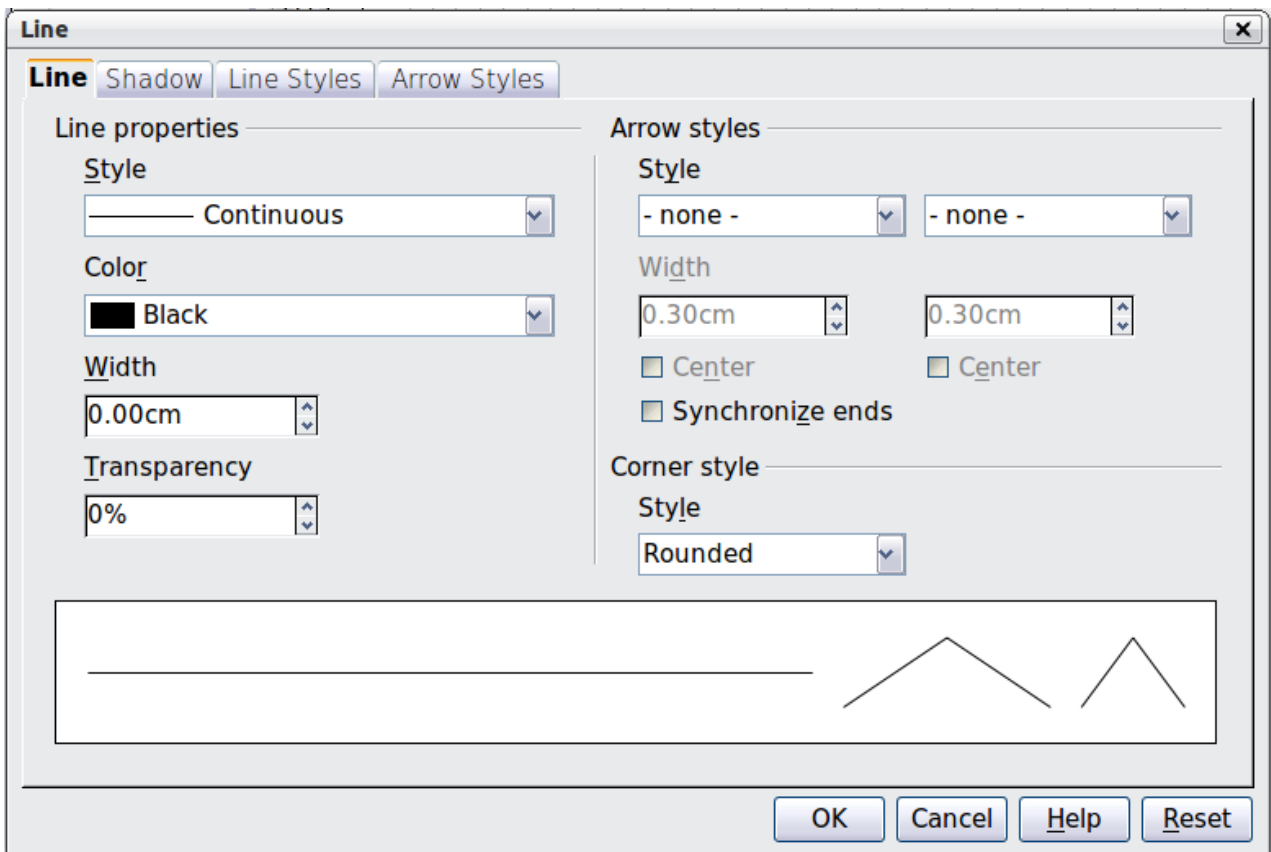

Figure 5: Line dialog (right-click on an object and choose Line).

Common line properties

In most cases the property you want to change is the line's style (solid, dashed, invisible, and so on), its color, or its width. These options are all available from the Line and Filling toolbar.



Figure 6: Common line options (style, width, color)

You can also edit these properties from the Line dialog. They are on the first tab, left column (see Figure 5). From the Line dialog you can also change the line's transparency. Figure 7 illustrates different degrees of transparency.

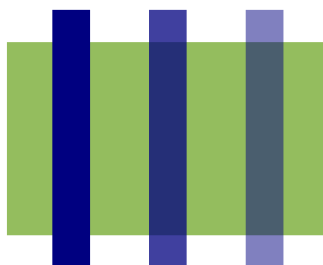



Figure 7: The vertical lines have different levels of transparency (0%, 25%, and 50%).

Drawing arrows

Arrowheads (and other line endings—usually referred to in this guide collectively as arrows) are a line property. Select a line and click on the **Arrow Style**  icon. This opens the Arrowheads menu.

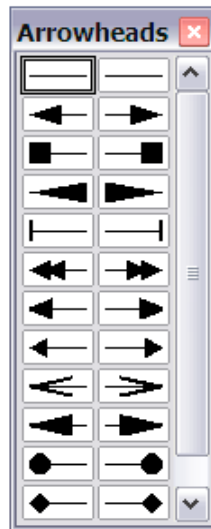

Figure 8: Arrowheads menu

There are several types of arrowheads available. Each end of the line can have a different arrowhead (or no arrowhead).

Note

Arrowheads are only applicable to lines. They have no effect on the border of an object.

In the Line dialog (Figure 5), *Arrow styles* on the right-hand side contains a number of options to fine tune the arrow properties. If **Synchronize ends** is selected, both line endings will have the same appearance. The **Center** option places the center of the arrow over the end point of the line. If this option is not selected, the line ends at the far edge of the arrow. The following sketch illustrates the difference.

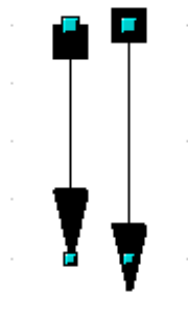

Figure 9: Default arrowheads (left) vs centered arrowheads (right)

Line shadows

Lines can have a shadow property associated with them.

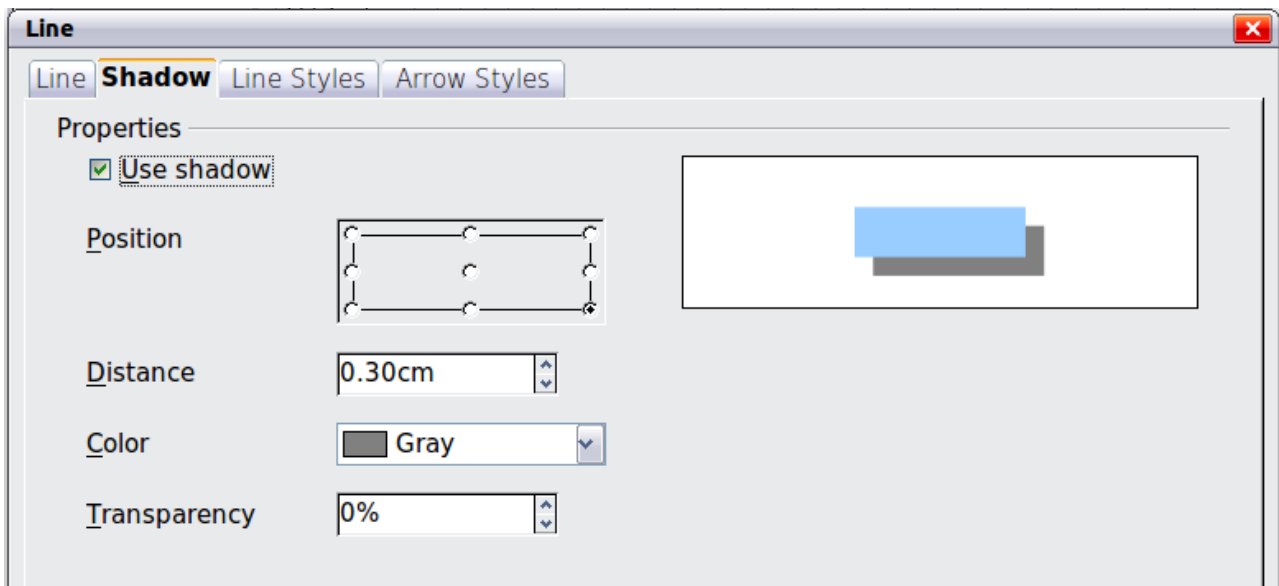



Figure 10: Shadow page of Line dialog

Check the box *Use shadow* to enable this feature. The properties shown—position, distance, color, and transparency—may be independently adjusted to your choice and the results seen in the preview window. You can also click on the Filling  icon on the **Line and Filling** toolbar—next to the area fill functions – to get a basic shadow.

Customizing line and arrow styles

You are not constrained to using the line and arrow styles provided by default in Draw. You can modify the styles and create your own.

Customizing line styles

In the Line dialog, click on the **Line Styles** tab (see Figure 11). From here you can customize the line styles or create your own by clicking on the **Add** button. You can change the length of the dashes, the space between them, and several other attributes.

Use the **Load Line Style**  and **Save Line Style**  icons to save a new definition or read one from disk (file extension **.sod**).

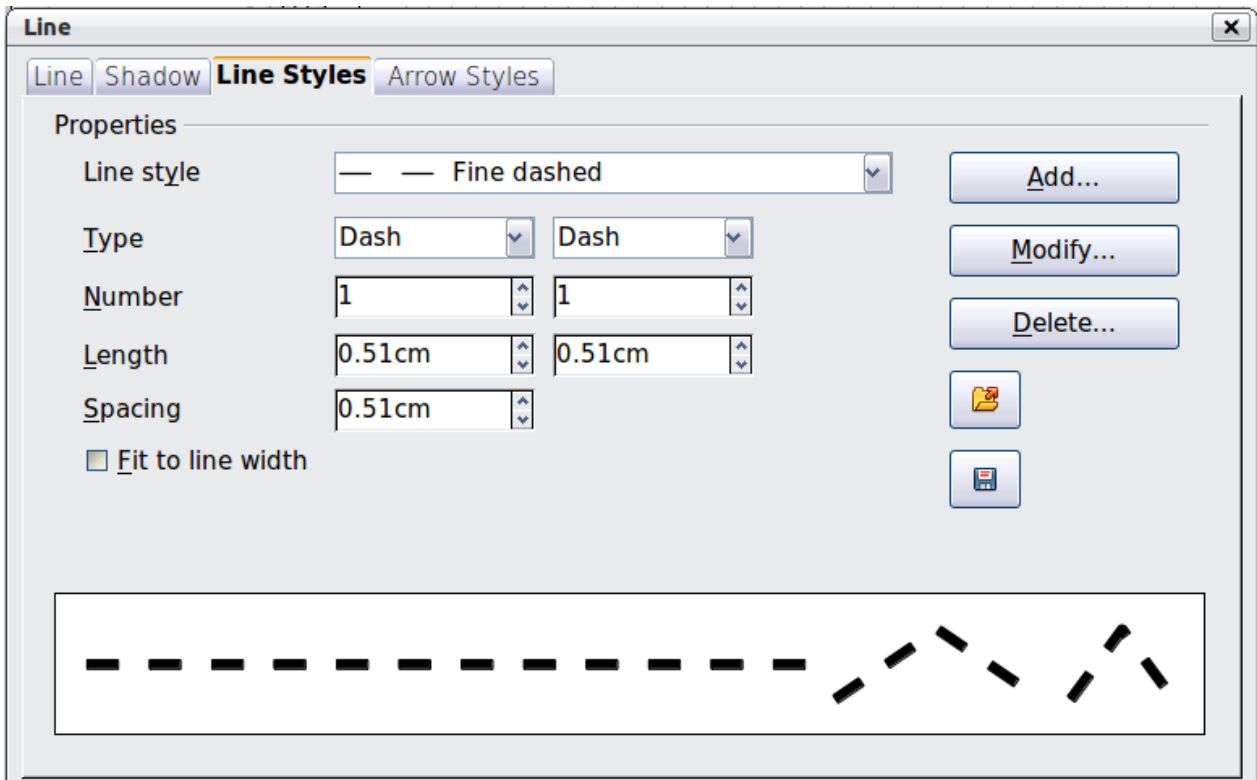
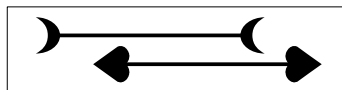

Figure 11: Editing line styles

Customizing arrow styles

You can also create your own arrowheads to provide some interesting effects, such as:



The first step is to draw a curve with the shape you want for the arrowhead.

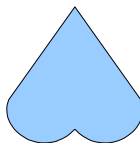

Figure 12: To create your own arrowhead, you must first draw a curve.

Note

The arrowhead must be a curve. A curve is something you could draw without lifting a pencil. For example, ☆ is a curve but ☺ is not a curve. You can however draw forms which are not curves and then at the end convert them to a curve.

Select the curve, open the Line dialog, and go to the **Arrow Styles** page. Click on **Add**, enter a name for the arrow style and click OK (see Figure 13).

Tip

The part of the shape which should point in the direction of the line must be drawn facing upwards. In Figure 12 the top of the shape will point towards the “outside” of the line.

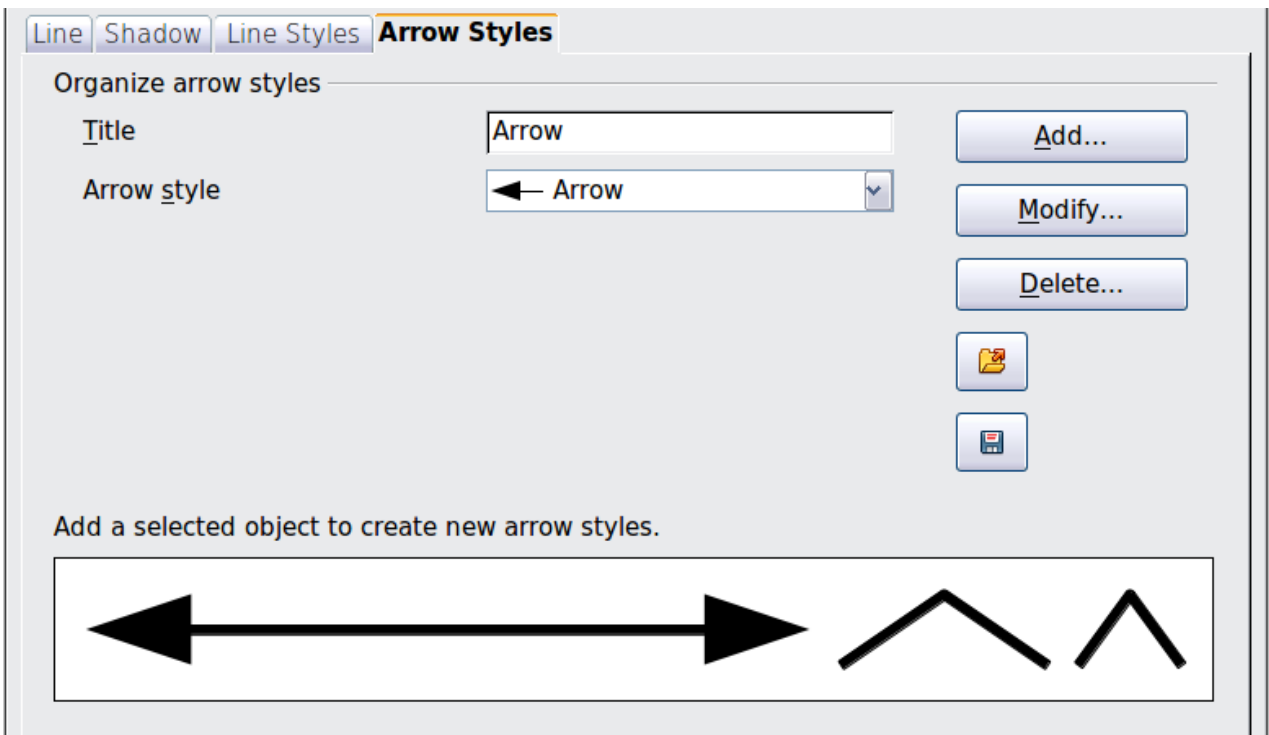

Figure 13: Adding an arrow style

Now you can access the new style from the *Arrow style list* (Figure 14) or the *Arrowheads* dialog (Figure 8).



Figure 14: Arrow style list

Editing the inside (fill) of an object

The LibreOffice term for the inside of an object is **Area fill**. The area fill of an object can be a uniform color, a gradient, a hatching pattern, or an image. It can be made partly or wholly transparent and can throw a shadow.

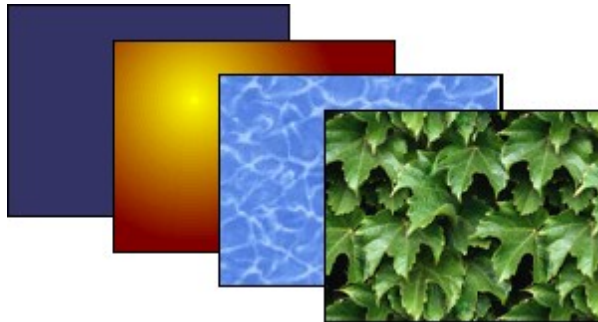

Figure 15: Different types of area fill

Common fill properties

In most cases, you will choose one of the standard fill options, whether it is a color, a gradient or an image. These options are all available from the Line and Filling toolbar.

If you want no fill at all, select the object you wish to edit and on the **Line and Filling** toolbar select the option **Invisible** on the pull down list at the right of the paint can.

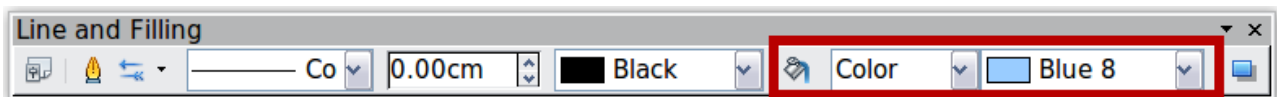

Figure 16: Common fill options

Fill with a uniform color

Select the object you wish to edit. On the **Line and Filling** toolbar, select **Color** on the pull down list at the right of the paint can, and then choose a color from the right-hand menu.

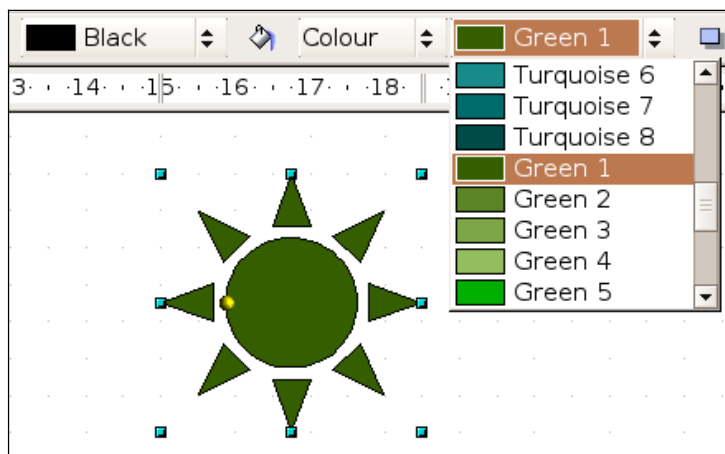

Figure 17: Filling with a color

Fill with a gradient

Select the object you wish to edit. On the **Line and Filling** toolbar, select **Gradient** and then choose a gradient from the right-hand menu.

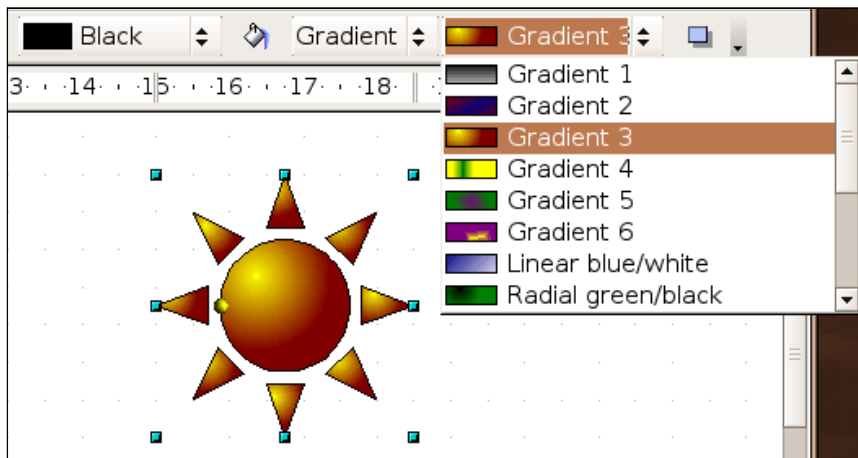

Figure 18: Filling with a gradient

Fill with a line pattern

The OOO term for line patterns is Hatching. Select the object you wish to edit. On the Line and Filling toolbar, select **Hatching** and then choose an option from the menu.

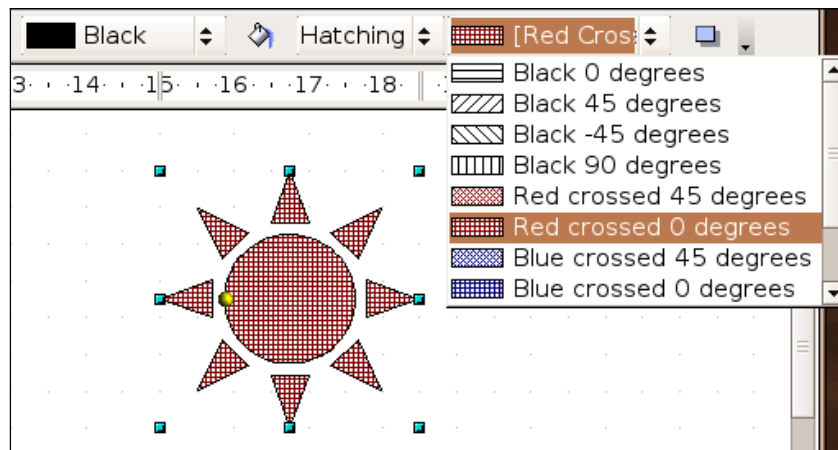

Figure 19: Filling with a line pattern

Fill with an image

You can fill an object with a bitmap image (as opposed to a vector graphic image). Select the object you wish to edit. On the **Line and Filling** toolbar, select **Bitmap** and then choose an option from the menu.

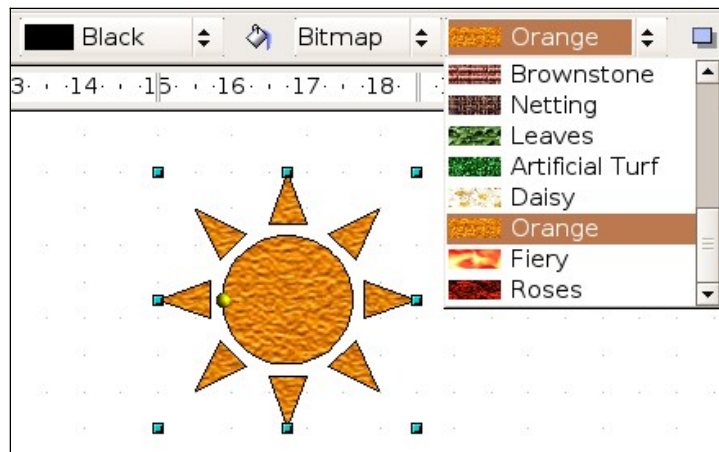

Figure 20: Filling with an image

Adding a shadow to an area

Click on the Filling  icon on the **Line and Filling** toolbar—next to the area fill functions (Figure 21).

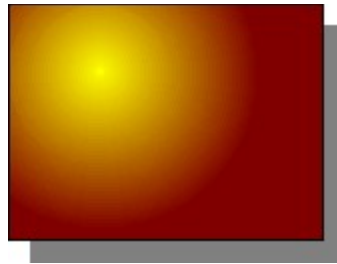



Figure 21: Adding a shadow

Advanced area fill options

Click on the **Area** icon  to bring up the Area dialog. From this dialog, you can fine tune the area fill of an object in greater detail.

Creating your own fill color

Click on the **Colors** tab of the Area dialog (Figure 22). From here you can modify existing colors or create your own.

Depending on the color model in use (RGB or CMYK can be selected from the pull down menu), you can change the individual values of the constituent colors—Red, Green, and Blue or Cyan, Magenta, Yellow, and Black. Click on **Add** to add this color to the color table. Clicking on the **Modify** button will change the values of the current color (here it is Blue 8, shown in the upper rectangle) to those on the screen in the lower rectangle. The **Edit** button allows you to fine tune the color using a palette with visual feedback.

Further explanation about color palettes can be found in Chapter 8, Tips and Tricks.

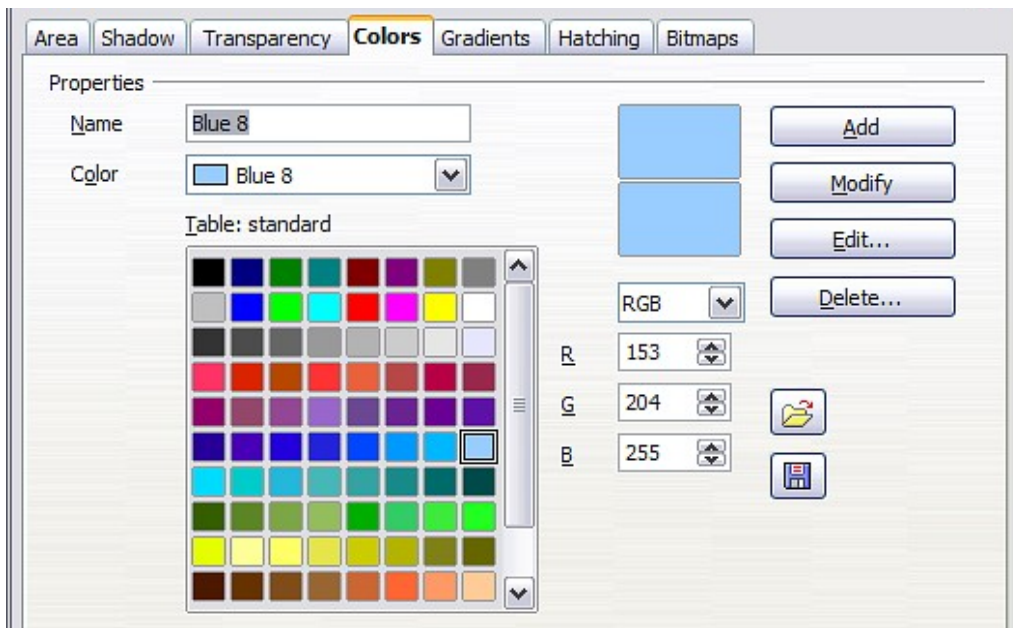

Figure 22: Customizing the color palette

Creating your own gradient

On the Area dialog, click on the **Gradients** tab. From here you can modify existing gradients or create your own.

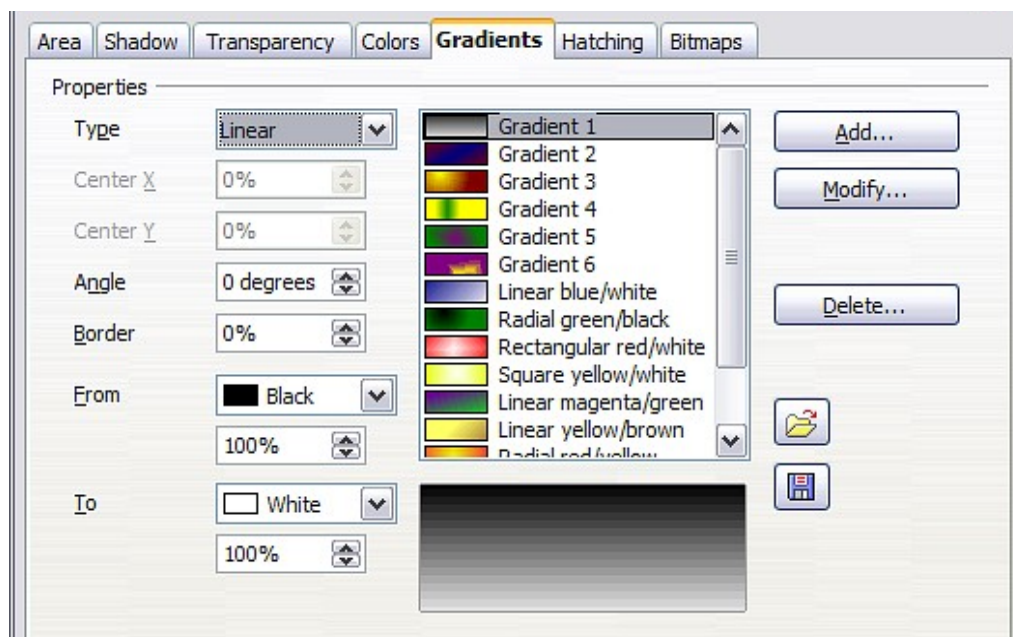

Figure 23: Customizing gradients

A gradient works by creating a smooth transition from one color to another. First, you need to choose two colors (Figure 24).

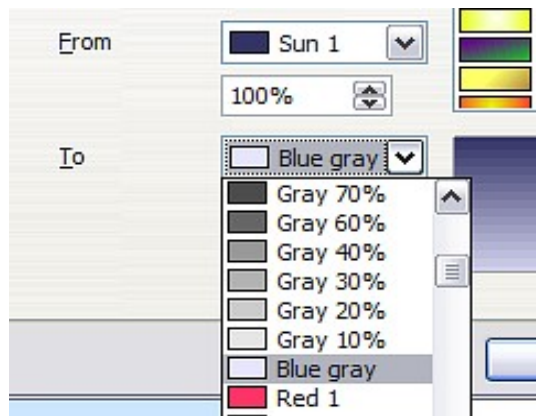

Figure 24: Choosing colors for a gradient

Then choose a type of gradient. There are several available (Linear, Axial, Radial, and so on) and each has up to four different options to specify it in detail. For example, a radial gradient has a center you can specify (Figure 25).



Figure 25: Center option in a radial gradient

Figure 26 shows how an ellipsoid gradient is rotated, moved vertically and horizontally, and the color of the border area varied.

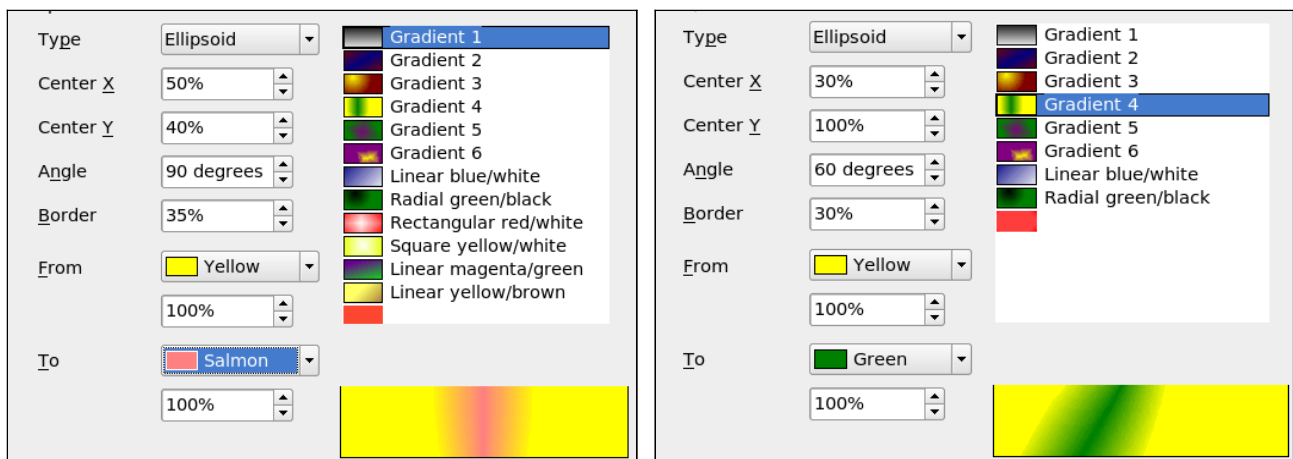

Figure 26: Center, Angle, and Border options for a gradient

Creating your own hatching (line pattern)

On the Area dialog, click on the **Hatching** tab (Figure 27). From here you can modify existing hatchings (line patterns) or create your own.

You can customize options like the spacing between lines, the angle and the color of the lines. There is no way to edit the line thickness.

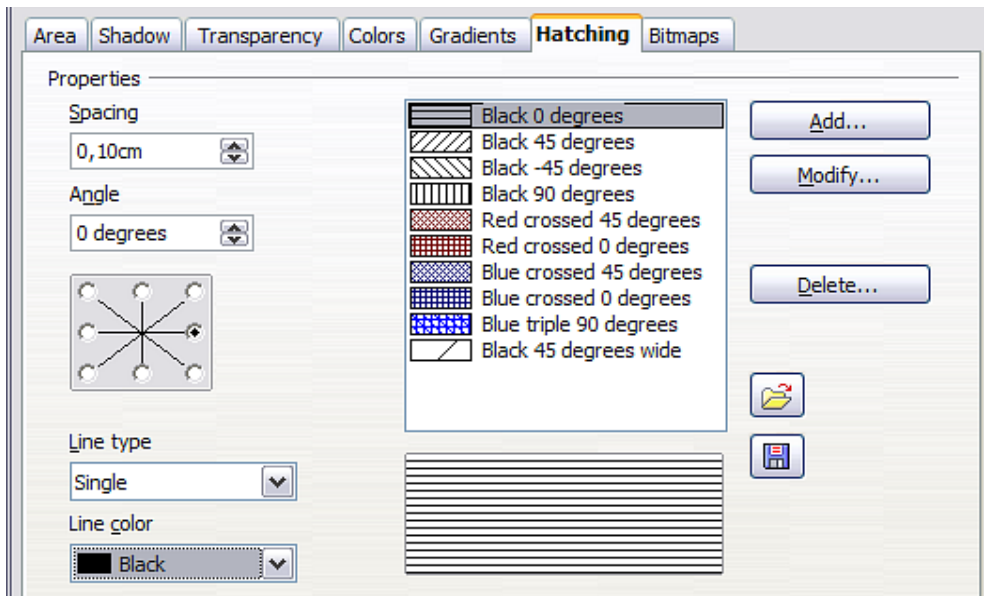

Figure 27: Modifying hatchings

Creating your own bitmap fill

You can add your own bitmap images to fill an area. First, you need to create the bitmap image. This could be a photo or another sketch you have created in another program. For example, you can draw something with Draw and **export** it as a PNG format image file.

To export a PNG image file: Create the image, select it, then choose **File > Export**, choose **PNG** from the pull-down list of file formats, give the file a name, and save it.

To use an image as a bitmap fill, open the Area dialog and click on the **Bitmaps** tab (Figure 28).

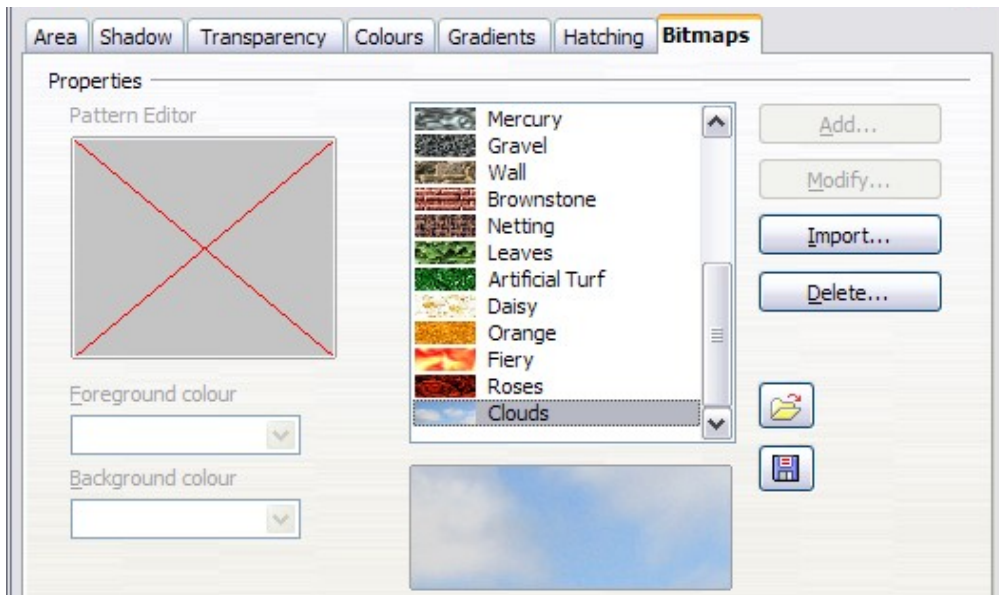

Figure 28: Adding your own bitmap images

From there you can add new bitmap images to serve as area fills. Click on **Import** and choose a file you previously saved. Give it a name that will make it easy to remember. The last imported image will appear at the bottom of the pull-down list of bitmap fills. Now you can use that image as an area fill.

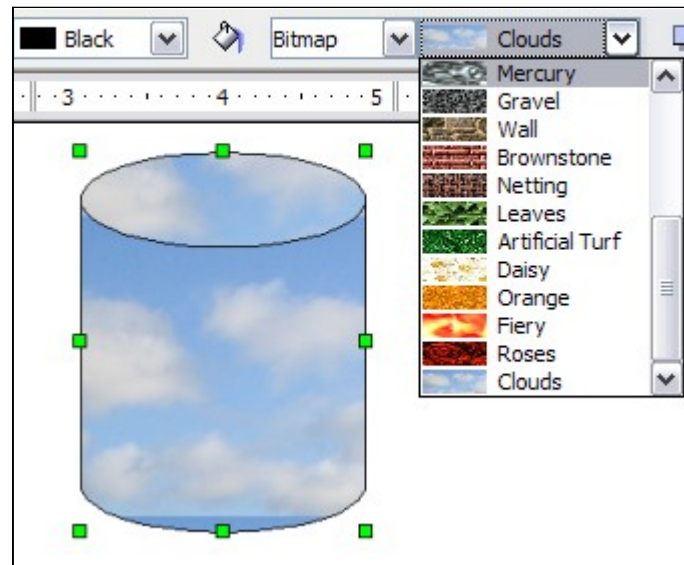

Figure 29: Adding your own bitmap images

Tip

If the imported image seems to be very small in the preview (Figure 27) you probably forgot to select the image before you exported it. In that case, the exported image would be the whole page with a (small) drawing on it.

Customizing shadows

First, select the object you want to apply a custom shadow to. Open the Area dialog and go to the **Shadow** tab (Figure 28). There you can customize the shadow's position, distance and color.

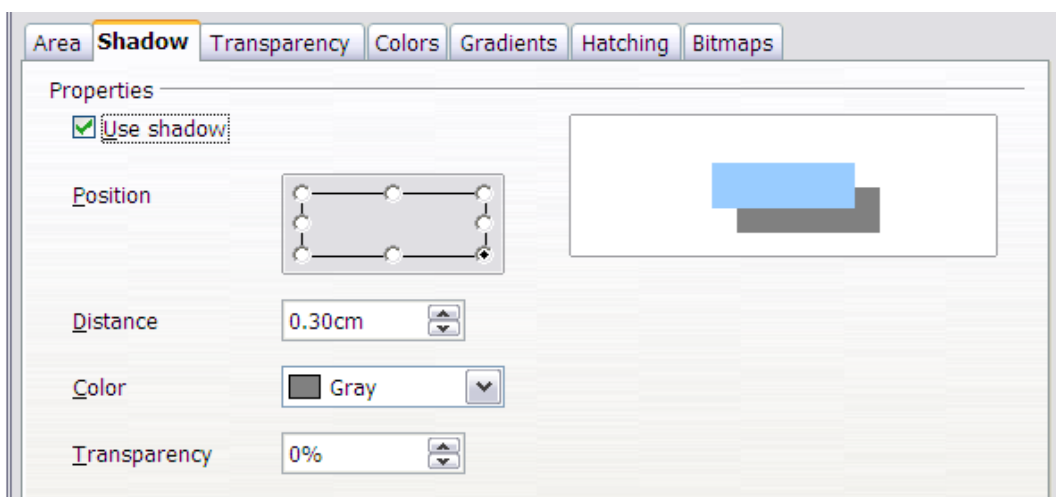

Figure 30: Customizing shadows

Shadows can also have transparency, so the shadow does not hide objects behind it.

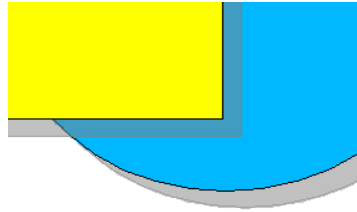

Figure 31: Shadow with 50% transparency

Adding transparency

You can make objects partly or fully transparent, or even a with a varying degree of transparency (as a gradient). On the **Transparency** page (Figure 32), choose **Transparency** (for a uniform transparency) or **Gradient** for a gradient transparency.

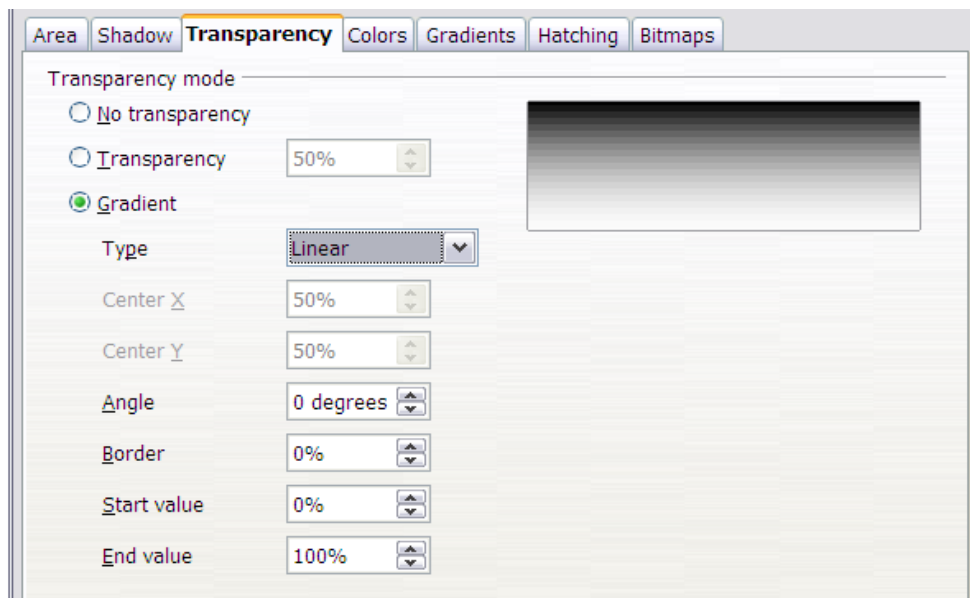

Figure 32: Transparency page of Area dialog

An example of gradient transparency is shown in Figure 33. See also “Dynamic gradients” on page 23.



Figure 33: Example of gradient transparency

Using styles

Suppose that you want to apply the same area fill, line thickness, and border to a set of objects. This repetitive process can be greatly simplified by the use of styles. Styles allow you to define a formatting template (a style) and then to apply that style to multiple objects. For more about styles, see Chapter 6, Introduction to Styles, in the *Writer Guide*.

Click on the **Styles and Formatting**  icon on the **Line and Filling** toolbar or press the *F11* key to open the Styles and Formatting window (Figure 34). This window can be docked to the left or right side of the main Draw window, if you wish.

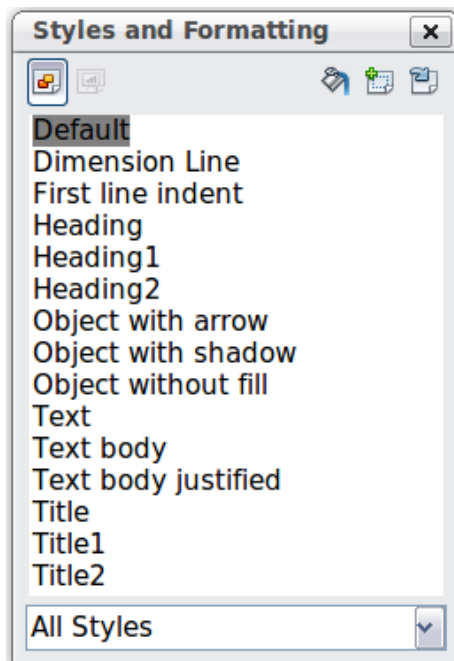



Figure 34: Styles and Formatting window

Creating a new style

Select an object and customize the area fill and border. When you are satisfied, click on the **New Style from Selection**  icon on the Styles and Formatting window. This defines a new style based on the selected object. Type a name for the new style and click **OK**.

Applying a style

Once the new style is defined, you can apply it to other objects. Select another object and double-click on the style name you defined. The new object will acquire the area fill and line properties of that style.

Tip

Question: What happens if I modify a style after it has been applied?

Answer: Then every object with that style is updated automatically!

Modifying a style

Modifying a style is similar to creating a new style. Select an object **with that style** and change the area and line properties. When satisfied, click on the **Update Style** icon . Alternatively click the **Styles and Formatting** icon or press *F11*, right-click the style you wish to modify and select **Modify**. Edit the properties you want to change and click **OK** to finish.

Special effects

First make sure that the Drawing toolbar is selected (**View > Toolbars > Drawing**). On the Drawing toolbar, locate the **Effects** icon . Click on the **arrow** next to that icon. This opens the Mode toolbar with all the special effect tools (see Figure 35).

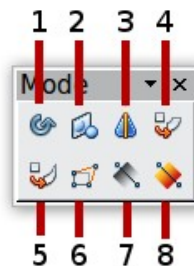

- | | | |
|-------------------------|-------------------------------|----------------|
| 1 Rotate | 4 Set in Circle (perspective) | 7 Transparency |
| 2 Flip | 5 Set to Circle (slant) | 8 Gradient |
| 3 In 3D Rotation Object | 6 Distort | |

Figure 35: Mode tear-off submenu

The tools are described in the following sections with the exception of the 3D rotation tool, which is described in Chapter 7, Working with 3D Objects.

Rotating an object

Click on the **Effects**  icon to select the **Rotate** tool. Then select an object. The selected object will have red handles instead of the usual green handles.

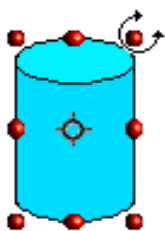

Grab one of the handles and move it to rotate the object. The black circle in the middle of the object is the pivot (center of rotation). You can move the location of the pivot with the mouse.

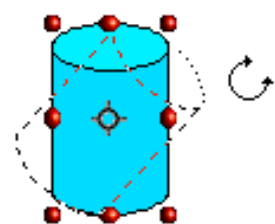

Flip an object

Select an object and click on the **Flip** icon . You will see a dashed line through the middle of the object.

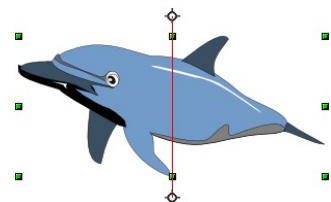

This dashed line is the **axis of symmetry**. The object will be reflected about this line. Move one or both ends of the line with your mouse to set the orientation of the axis.

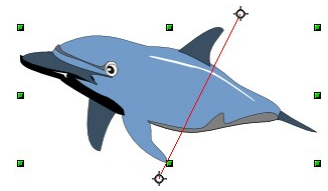

Then, grab any one of the eight green handles and move it across to the other side of the dashed line. The new position of the figure is shown faintly until the mouse is released.

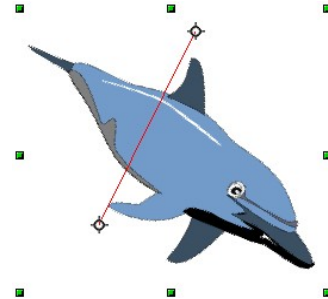

Note

If you press the *Shift* key while moving the line, the line will rotate in 45-degree increments.

Mirror copies

Officially, this useful command does not (yet) exist in Draw. It can, however, be easily emulated.

Move the axis of symmetry to the desired location of the mirror axis. Copy the object to the clipboard. Flip the object, then click on an empty area of the Draw screen in order to deselect the object. Paste from the clipboard to put a copy of the object in its original location and now you have a mirror copy.

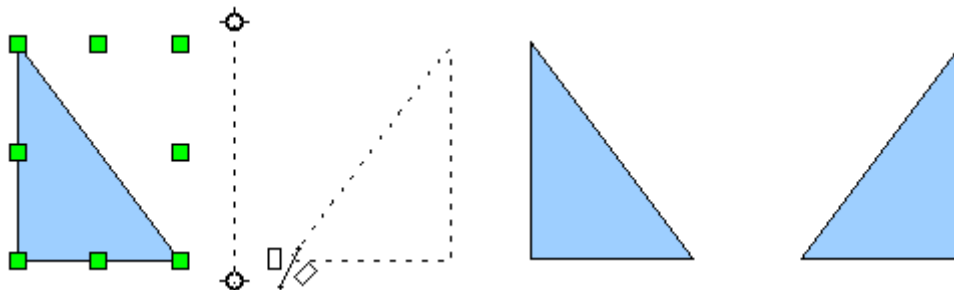

Figure 36: Making a mirror copy of an object

Distorting an image

There are three tools on the **Effects** menu that let you drag the corners and edges of an object to distort the image.

The **Distort** tool distorts an object in perspective, the **Set to Circle (slant)** and **Set in Circle (perspective)** tools both create a pseudo three-dimensional effect.

The results of using these tools are shown in the following figures.

Distort an object

Select an object and click on the **Distort** icon . Draw will ask if you want to transform the object to a curve. This is a necessary step before distortion, so click **Yes**. Then you can move the object handles to stretch it.

The corner handles distort, as shown in Figure 37. The midpoint handles distort the figure either horizontally (handle on vertical side of figure) or vertically (handle on horizontal side of figure).

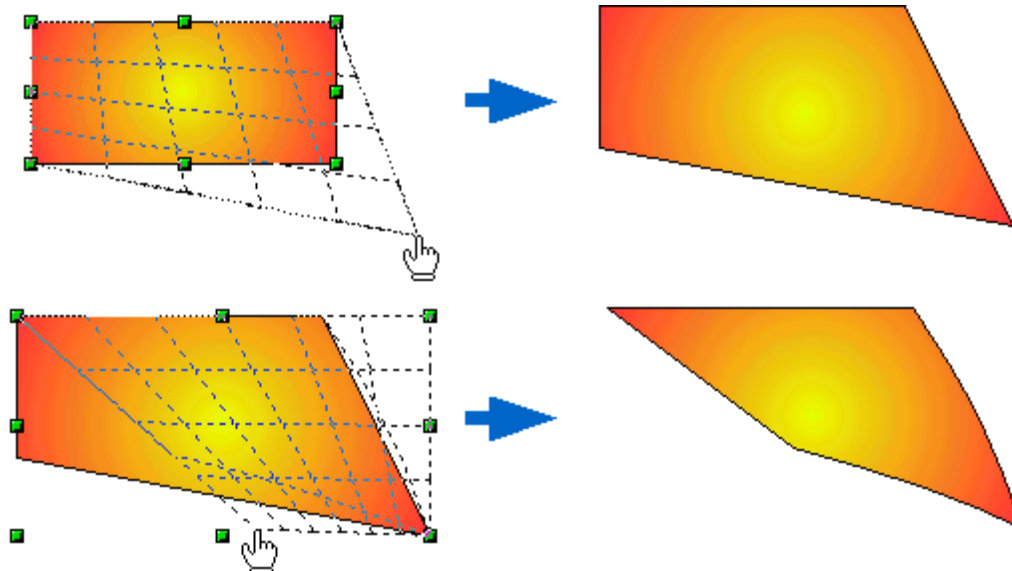



Figure 37: Distort an image

Set in circle (perspective)

Select an object and click on the **Set in Circle (perspective)** icon . Draw will ask if you want to transform the object to a curve. This is a necessary step before distortion, so click **Yes**. Then you can move the object handles to give a pseudo three-dimensional perspective).

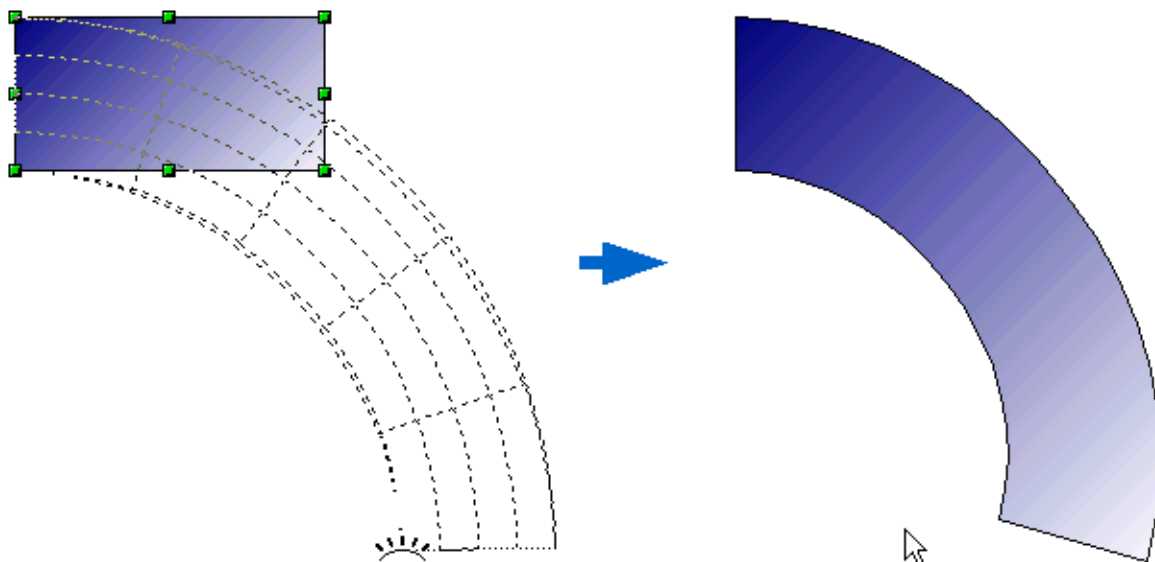



Figure 38: Set an image in a circle with perspective

Set to circle (slant)

Select an object and click on the **Set to Circle (slant)**  icon. Draw will ask if you want to transform the object to a curve. This is a necessary step before distortion, so click **Yes**. Then you can move the object handles to give a pseudo three-dimensional slant perspective.

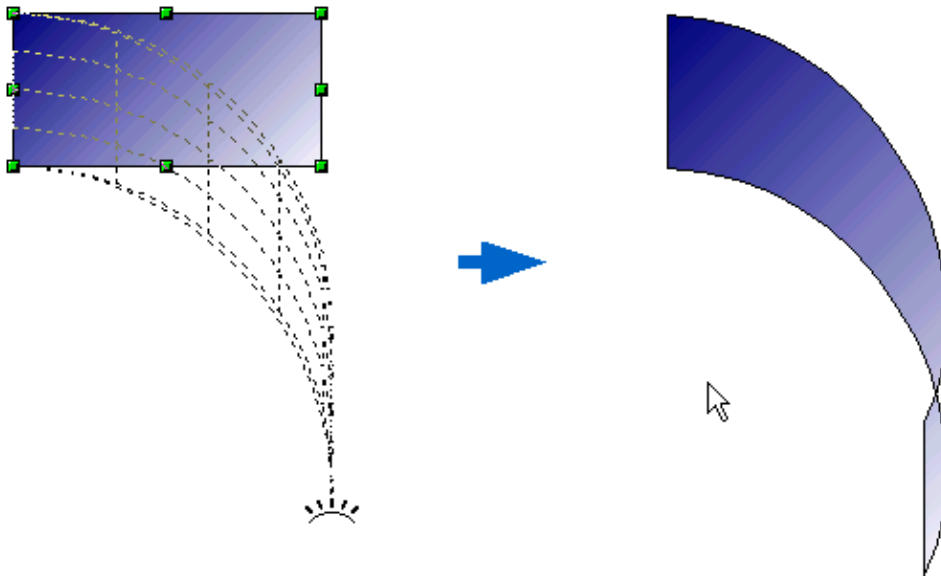

Figure 39: Set an image to a circle with slant perspective

Note

Transforming an object into a curve is a safe operation, but it cannot be reversed other than by clicking the **Undo** button.

Dynamic gradients

You can control transparency gradients in the same manner as color gradients. Both types of gradient can be used together. With a transparency gradient, the direction and degree of an object's fill color changes from opaque to transparent (in a regular gradient, the fill changes from one color to another, but the degree of transparency remains the same).

If you have assigned transparency to an object with a color fill, you can control the transparency by

clicking on the **Transparency** icon . To define a transparent gradient, select an object, choose a transparency fill from the **Line and Filling** toolbar. The transparency icon is now active. When you click on this icon, a dashed line connecting two squares appears on the object. Move the two squares to modify the gradient. You can define the direction of the gradient (vertical, horizontal, or at any angle) and the spot at which the transparency begins.

A regular color gradient can be defined in the same manner. Select an object, choose a gradient fill

from the **Line and Filling** toolbar. The **Gradient** icon  is now active. When you click on the gradient icon, a dashed line connecting two squares appears on the object, just as it does for a transparency gradient.

In both cases, click outside the object to set the gradient.

Note

If the transparency and gradient icons are not visible, you can display them using **View > Toolbars > Mode**.

Moving the squares will have different effects, depending on the type of gradient. For example, for a linear gradient, the start and end squares of the gradient will always be situated to either side of the center point of the object.

The three examples in Figure 40 demonstrate how the type and degree of transparency can be controlled.

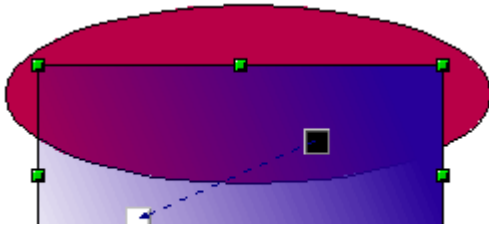

A single color object and a transparency gradient, covering part of the underlying object.

The gradient can be dynamically adjusted, made more transparent by moving the white square or more opaque by moving the black square.

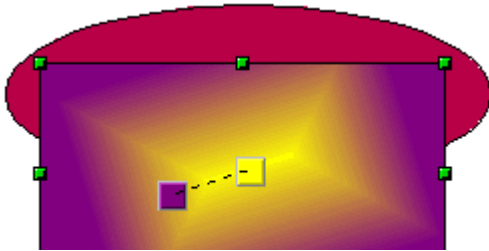

An object with a color gradient, completely covering another object.

The gradient is adjusted dynamically by moving the squares – the color of the square relating to the increase or decrease in that color.

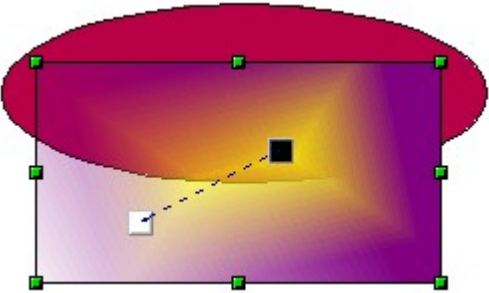

An object with both color and transparency gradients, partly covering the underlying object.

Figure 40: Dynamic gradients