

**LibreOffice**  
The Document Foundation

Draw Guide

*Chapter 10*  
*Advanced Draw Techniques*

## Copyright

---

This document is Copyright © 2005–2012 by its contributors as listed below. You may distribute it and/or modify it under the terms of either the GNU General Public License (<http://www.gnu.org/licenses/gpl.html>), version 3 or later, or the Creative Commons Attribution License (<http://creativecommons.org/licenses/by/3.0/>), version 3.0 or later.

All trademarks within this guide belong to their legitimate owners.

## Contributors

Martin Fox  
John A Smith

John Cleland  
Peter Schofield

Jean Hollis Weber

## Feedback

Please direct any comments or suggestions about this document to:  
[documentation@global.libreoffice.org](mailto:documentation@global.libreoffice.org)

## Acknowledgments

This chapter is based on an original French document written for OpenOffice.org 1.x by Michel Piquier (translated into English by Alex Thurgood) and previous content revised by Jim Taylor. The chapter was revised for OpenOffice.org 2.0 by Linda Worthington, Daniel Carrera, Jean Hollis Weber, and Agnes Belzunce, and later translated into German by Wolfgang Uhlig. The German revisions were then translated into English and revised for OpenOffice.org 3.3 and LibreOffice 3.3 by Martin Fox. Other contributors included Peter Hillier-Brook, Hazel Russman, Gary Schnabl, and Claire Wood.

## Publication date and software version

Published 20 October 2012. Based on LibreOffice 3.5.

## Note for Mac users

---

Some keystrokes and menu items are different on a Mac from those used in Windows and Linux. The table below gives some common substitutions for the instructions in this chapter. For a more detailed list, see the application Help.

<b>Windows or Linux</b>	<b>Mac equivalent</b>	<b>Effect</b>
<b>Tools &gt; Options</b> menu selection	<b>LibreOffice &gt; Preferences</b>	Access setup options
<i>Right-click</i>	<i>Control+click</i> and/or <i>right-click</i> depending on computer system	Open context menu
<i>Ctrl (Control)</i>	⌘ ( <i>Command</i> )	Used with other keys
<i>F5</i>	<i>Shift+⌘+F5</i>	Open the Navigator
<i>F11</i>	⌘+T	Open Styles and Formatting window

# Contents

---

<b>Copyright</b> .....	<b>2</b>
<b>Note for Mac users</b> .....	<b>2</b>
<b>Multi-page documents</b> .....	<b>5</b>
Using the page pane.....	5
Master pages.....	6
Master page view.....	6
Creating master pages.....	6
Renaming master pages.....	7
Deleting master pages.....	7
Inserting fields.....	7
Assigning master pages.....	7
<b>Multiple layers</b> .....	<b>8</b>
Default layers.....	8
Inserting layers.....	9
Modifying layers.....	9
Working with layers.....	10
Selecting a layer.....	10
Hiding layers.....	10
Showing hidden layers.....	10
Locking layers.....	10
Unlocking layers.....	10
Renaming layers.....	10
Deleting layers.....	10
<b>Dimensioning</b> .....	<b>11</b>
Configuring dimensioning.....	11
Configuring using graphic styles.....	11
Configuring using context menu.....	11
Dimensioning options.....	12
Dimensioning objects.....	13
<b>Drawing to scale</b> .....	<b>13</b>
<b>Gallery images</b> .....	<b>14</b>
Using the Gallery.....	14
Adding images to My themes.....	15
Deleting graphics.....	16
Adding a new theme.....	16
<b>Colors and color palettes</b> .....	<b>17</b>
Using colors.....	17
Selecting colors.....	19
Color palettes.....	19
Creating colors.....	19
Using color values.....	19
Using the color picker.....	19
Deleting colors.....	20
<b>Bézier curves</b> .....	<b>20</b>

Drawing a Bézier curve.....	21
Edit Points tools.....	22
<b>Adding comments to a drawing.....</b>	<b>24</b>
<b>Connecting and breaking lines.....</b>	<b>24</b>

## Multi-page documents

Draw documents, like Impress presentation documents, can consist of multiple pages. This allows you to create a drawing that has several sections, but is stored as one file on a computer.

When pages are inserted into a drawing, they are automatically named as *Slide 1*, *Slide 2*, and so on. As you change page order, the pages are automatically renumbered. However, if you want to identify each page easily, you are recommended to give each page a memorable name.

### Using the page pane

By default the **Page Pane** (Figure 1) appears docked on the left of the workspace when you open Draw. It shows every page in a drawing as a thumbnail. If the Page Pane is not displayed, go to **View > Page Pane** on the main menu bar.

#### Note

The **Page Pane** is called **Pages** when it is in its docked position on the left of the workspace.

- Select a thumbnail in the Page Pane and the corresponding page is loaded in the workspace. Click on the page in the workspace to activate it for editing. Alternatively, click on the **Navigator** icon  or press the **F5** key or go to **View > Navigator** on the main menu bar to open the **Navigator** dialog (Figure 2) and select pages using this dialog.

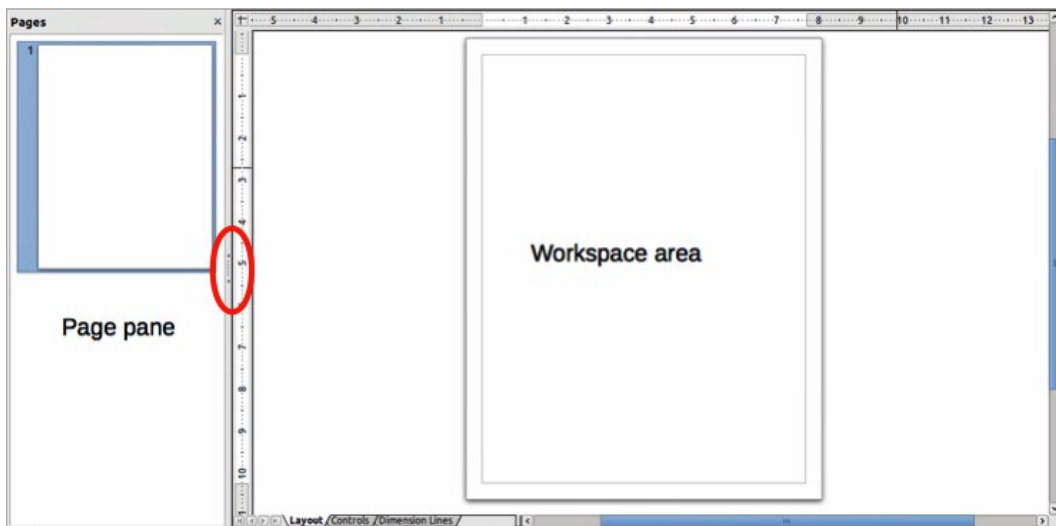

Figure 1: Page pane and workspace

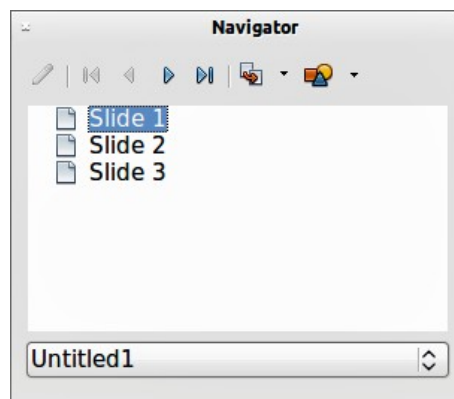

Figure 2: Navigator dialog

- Select a thumbnail in the Page pane, then drag and drop the thumbnail to change the order of pages in the document.
- Click and drag on the separator line between the Page pane and the workspace to change the width of the Page pane.
- Click on the middle of this line to show or hide the Page pane (highlighted in Figure 1).
- Press and hold the *Ctrl* key, then double-click in the title bar of the Page pane to undock it and turn it into a floating window.
- Press and hold the *Ctrl* key, then double-click in the title bar of the undocked Page pane to dock it back into its default position on the left of the workspace.
- Right-click in the page pane and use the options in the context menu to insert, delete or rename pages and to cut, copy and paste pages.
- Go to **Insert > Slide** on the main menu bar to insert a new page or **Insert > Duplicate Slide** to insert a duplicate page.

## Master pages

A master page is a page that is used as the starting point for other pages in your drawing. It is similar to a page style in Writer: it controls the basic formatting of all pages based on it. A drawing can have more than one master page so that you can assign a different look to other pages in your drawing.

A master page has a defined set of characteristics, including the background color, graphic, or gradient; objects (such as logos, decorative lines, and other graphics) in the background, the formatting of text, blocks of standard text, and inserted fields such as page numbering, date and filename.

### Note

LibreOffice uses interchangeable terms for one concept: slide master, master slide, and master page. All refer to a page which is used to create other pages. When searching for information in Draw Help, it may be necessary to use alternative search terms.

## Master page view

To add objects and fields to a master page, go to **View > Master** to open the master page view. The **Master View** toolbar (Figure 3) also opens when you switch to master view. If this toolbar does not appear, go to **View > Toolbars > Master View**.

To return to normal page mode, click on **Close Master View** in the Master View toolbar or go to **View > Normal** on the main menu bar.

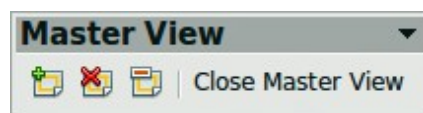



Figure 3: Master View toolbar

## Creating master pages

Each drawing you create already has a default master page, but you can create extra master pages to change the look of some of the pages in your multi-page drawing.

Switch to Master View and then click on the **New Master** icon  in the Master View toolbar to create a new master page. The new master page is automatically selected allowing you to add a new set of items to create a new look for your pages.

## Renaming master pages

Each new master page created has the default name of Default 1, Default 2, and so on. It is recommended to rename your new master page with a more meaningful name. The default master page that was created when you first created your drawing can also be renamed.

Switch to Master View and then right-click on a master page in the Page pane and select **Rename Page** from the context menu or click on the **Rename Master** icon  on the Master View toolbar. This opens a dialog where you can type a new name. Click on the **OK** button to save the new name.

## Deleting master pages

Switch to Master View and then select the master page you want to delete. Right-click on a master page that you created in the Page pane and select **Delete Page** from the context menu or click on the **Delete Master** icon  on the Master View toolbar.

The delete option and delete icon are only available when there is more than one master page in your drawing. You cannot delete the default master page that was created when you first created your drawing.

## Inserting fields

You can insert fields on each master page by going to **Insert > Fields** on the main menu bar and selecting a field from the context menu. The following fields can be inserted into a master page.

- **Date (fixed)** – inserts the current date into your master page as a fixed field. The date is not automatically updated.
- **Date (variable)** – inserts the current date into your master page as a variable field. The date is automatically updated when you reload the file.
- **Time (fixed)** – inserts the current time into your master page as a fixed field. The time is not automatically updated.
- **Time (variable)** – inserts the current time into your master page as a variable field. The time is automatically updated when you reload the file.
- **Author** – inserts the first and last names listed in the LibreOffice user data into the active page.
- **Page Number** – inserts the page number into every page of your drawing. To change the number format, go to **Format > Page** on the main menu bar and select a format from the drop down list in *Layout Settings*.
- **File name** – inserts the name of the active file. The name only appears after you save the file.

## Assigning master pages

When your drawing has more than one master page, you can assign different master pages to different pages.

- 1) Make sure you are in normal page view by going to **View > Normal** on the main menu bar and select the page to which you want to assign a new master page.
- 2) Right-click on the page in the workspace area and select **Page > Slide Design** from the context menu to open the **Slide Design** dialog (Figure 4).
- 3) Click the **Load** button to open the **Load Slide Design** dialog and use any predefined master pages. All Draw and Impress templates can be used for this purpose.

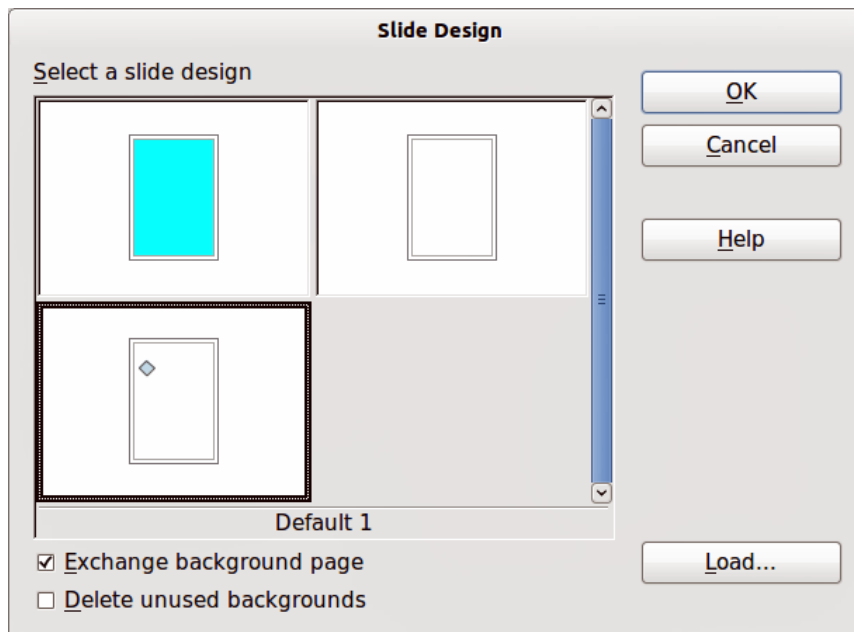

Figure 4: Slide design dialog

- 4) Select the **Exchange background page** option and the selected master page will be used on all pages of the drawing.
- 5) Select the **Delete unused backgrounds** option to delete any master pages shown in the Slide Design dialog that have not been assigned to a page.
- 6) Click on the **OK** button to assign the selected master page to your page.

## Multiple layers

Layers in LibreOffice Draw allow you to assemble elements on a drawing page that are related. Think of layers as individual workspaces that you can hide from view, hide from printing, or lock. Any layers that do not contain any objects are transparent.

### Note

You can lock a layer to protect its contents, or hide a layer and its contents from view or from printing. When you add a new layer, the layer is added to all of the pages in your drawing. However, when you add an object to a layer, it is only added to the current drawing page.

If you want the object to appear on all of the pages (for example, a company logo), add the object to the master page by going to **View > Master**. To return to your drawing, go to **View > Normal**.

Layers do not determine the stacking order of objects on your drawing page, except for the **Controls** layer which is always in front of all other layers. The stacking order of objects on your drawing page is determined by the sequence in which you add the objects. You can rearrange the stacking order by going to **Modify > Arrange** on the main menu bar.

## Default layers

LibreOffice Draw provides three default layers, which cannot be deleted or renamed.

- **Layout** – is the default workspace and determines the location of title, text and object placeholders on your drawing page.



- **Controls** – used for buttons that have been assigned an action, but should not be printed and the layer properties are set to not printable. Objects on this layer are always in front of objects on other layers.
- **Dimension Lines** – is where the dimension lines are drawn. By switching the layer to show or hide, you can easily switch dimension lines on and off.

## Inserting layers

- 1) Right-click the layer tab area at the bottom and select **Insert Layer** from the context menu, or go to **Insert > Layer** on the main menu bar to open the **Insert Layer** dialog (Figure 5).
- 2) Type a meaningful name for the layer in the *Name* text box.
- 3) Type a meaningful title for the layer in the *Title* text box.
- 4) If necessary, type a description for the layer in the *Description* text box.
- 5) Select *Visible* if you want the layer to be visible in your drawing. When *Visible* is not selected, a layer is hidden and the title in the layer tab changes color to blue.
- 6) Select *Printable* if you want the layer to print when you print your drawing. Not printing is useful if you want use a draft layer for guides or annotations that you use in making the drawing, but do not want to appear in the final output.
- 7) Select *Locked* to prevent any objects on this layer from deletion, editing, or moving. No additional objects can be added to a locked layer. Locking a layer is useful, for example, when a base plan is to be protected while adding a new layer with other details.
- 8) Click **OK** and the new layer automatically becomes active.

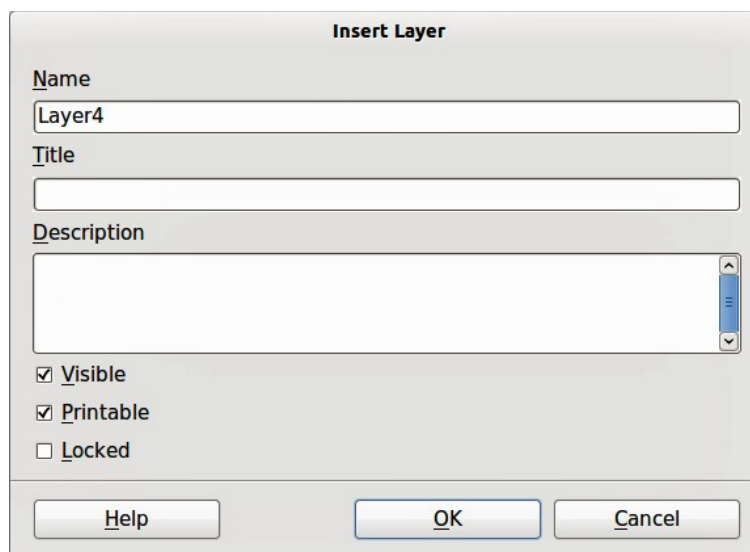

Figure 5: Insert Layer dialog

## Modifying layers

- 1) Right-click on the name tab of the layer and select **Modify Layer** from the context menu or double-click on the name tab to open the **Modify Layer** dialog. This dialog is similar to the Insert Layer dialog in Figure 5.
- 2) Make your changes to the layer, then click **OK** to save the changes and close the dialog.

## Working with layers

### Selecting a layer

To select a layer, click on the name tab of the layer at the bottom of the drawing workspace.

### Hiding layers

- 1) Select a layer, and right-click on the name tab of the layer and select **Modify Layer** from the context menu or double-click on the name tab to open the **Modify Layer** dialog.
- 2) Clear the *Visible* check box and click **OK**. The text for the name tab changes color to blue. Any objects placed on a hidden layer will no longer be visible on the other layers in your drawing. Alternatively, hold down the *Shift* key and click on the name tab.

### Showing hidden layers

- 1) Select a hidden layer, and right-click on the name tab of the layer and select **Modify Layer** from the context menu or double-click on the name tab to open the **Modify Layer** dialog.
- 2) Check the *Visible* check box and click **OK**. The text for the name tab changes to the default color for text for your computer setup. Any objects placed on a hidden layer will now become visible on the other layers in your drawing. Alternatively, hold down the *Shift* key and click on the name tab.

### Locking layers

- 1) Select a layer, and right-click on the name tab of the layer and select **Modify Layer** from the context menu or double-click on the name tab to open the **Modify Layer** dialog.
- 2) Check the *Locked* check box and click **OK** to prevent any modification of the layer.

### Unlocking layers

- 1) Select a layer, and right-click on the name tab of the layer and select **Modify Layer** from the context menu or double-click on the name tab to open the **Modify Layer** dialog.
- 2) Uncheck the *Locked* check box and click **OK** to allow modification of the layer.

### Renaming layers

To rename a layer that you have added to your drawing:

- 1) Right-click on the name tab of the layer and select **Rename Layer** from the context menu.
- 2) Type a new name for your layer and click outside the tab area to save the change.

#### Note

You can also rename a layer using “Modifying layers” on page 9.

### Deleting layers

To delete a layer that you have added to your drawing:

- 1) Right-click on the name tab of the layer and select **Delete Layer** from the context menu.
- 2) Confirm the deletion and the layer and all its objects are deleted.

## Dimensioning

Draw allows you to dimension objects and display these dimensions to make your drawing look more like an engineering drawing. When you create dimensions, they are automatically placed on the **Dimension Lines** layer (see “Default layers” on page 8 for more information).

### Configuring dimensioning

Two ways are available to access the options to configure dimensioning. Both methods use a similar dialog to set the dimensioning options where you can change length, measurement and guide properties of a dimension line.

#### Configuring using graphic styles

- 1) Go to **Format > Styles and Formatting** or press the *F11* key on your keyboard to open the **Styles and Formatting** dialog.
- 2) Select *Dimension Line* in the Styles and Formatting dialog.
- 3) Right-click on *Dimension Line* and select *Modify* from the context menu to open the **Graphics Styles** dialog (Figure 6). See the *Impress Guide* for more information about graphic styles.
- 4) Click on the **Dimensioning** tab to open the **Dimensioning** options page.
- 5) To reset the dimensioning options to the default properties of the template, click **Standard**.

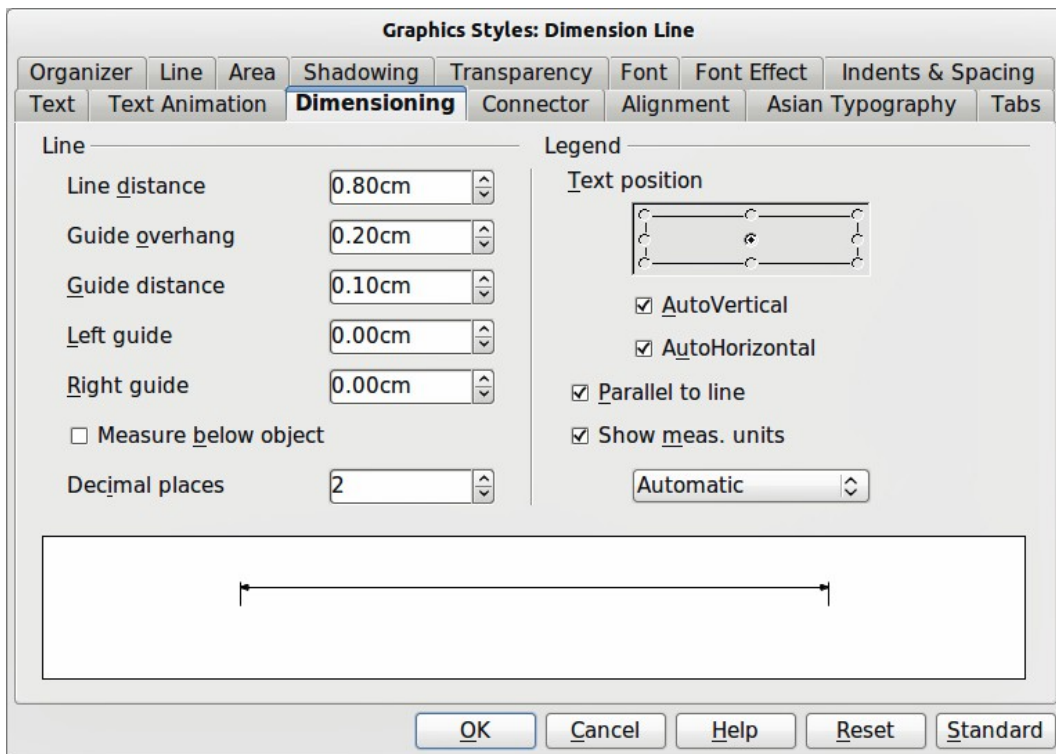

Figure 6: Graphic Styles Dimensioning dialog

#### Configuring using context menu

- 1) Draw a dimension line. See “Dimensioning objects” on page 13 for more information.
- 2) Right-click on the dimension line and select **Dimensions** from the context menu to open the **Dimensioning** dialog (Figure 7).

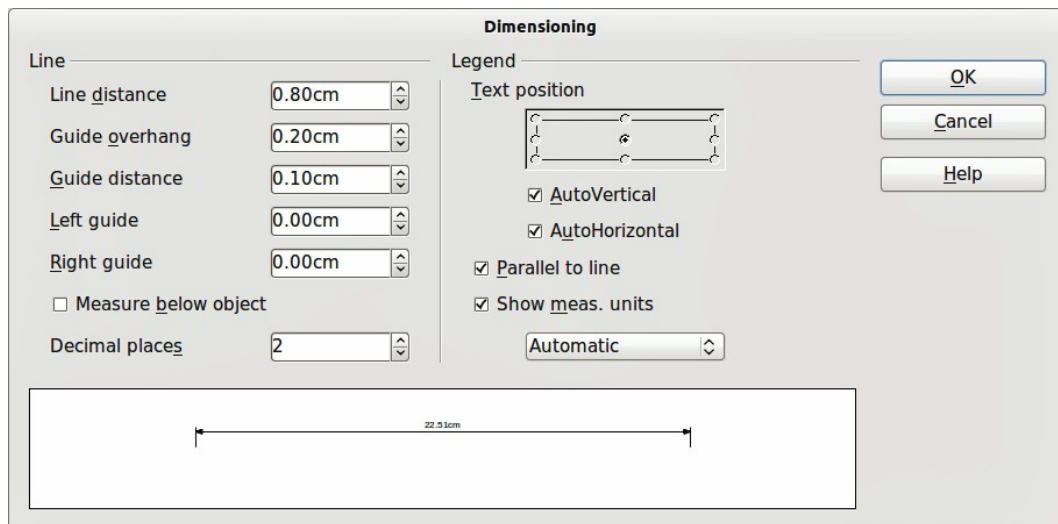

Figure 7: Context menu Dimensioning dialog

### Dimensioning options

With reference to Figure 6 and Figure 7, the dimensioning options are as follows.

- **Line** – sets the distance properties of the dimension line and the guides with respect to each other and to the baseline.
  - *Line distance* – specifies the distance between the dimension line and the baseline (line distance = 0).
  - *Guide overhang* – specifies the length of the left and right guides starting at the baseline (line distance = 0). Positive values extend the guides above the baseline and negative values extend the guides below the baseline.
  - *Guide distance* – specifies the length of the right and left guides starting at the dimension line. Positive values extend the guides above the dimension line and negative values extend the guides below the dimension line.
  - *Left guide* – specifies the length of the left guide starting at the dimension line. Positive values extend the guide below the dimension line and negative values extend the guide above the dimension line.
  - *Right guide* – specifies the length of the right guide starting at the dimension line. Positive values extend the guide below the dimension line and negative values extend the guide above the dimension line.
  - *Measure below object* – reverses the properties set in the Line options.
  - *Decimal places* – specifies the number of decimal places used for the display of line properties.
- **Legend** – sets the properties of the dimension text.
  - *Text position* – determines the position of the dimension text with respect to the dimension line and the guides. The *AutoVertical* and *AutoHorizontal* checkboxes must be cleared before you can assign a text position.
  - *AutoVertical* – determines the optimal vertical position for the dimension text.
  - *AutoHorizontal* – determines the optimal horizontal position for the dimension text.
  - *Parallel to line* – displays the text parallel to or at 90 degrees to the dimension line.
  - *Show meas. units* – shows or hides the dimension measurement units. You can also select a measurement unit you want to display from the list.

## Note

The dimensioning style Dimension Line is always linked and stored with the current work page. All the changes that you make apply only to this page. New drawings are started with the standard properties of Draw. If you want to use the amended style for future drawings, save your drawing as a template.

## Tip

When dimensioning objects, it is recommended to use the zoom function, guide lines and snap functions so that you can accurately place dimension lines on an object. See *Chapter 3 Working with Objects and Object Points* for more information.

## Dimensioning objects

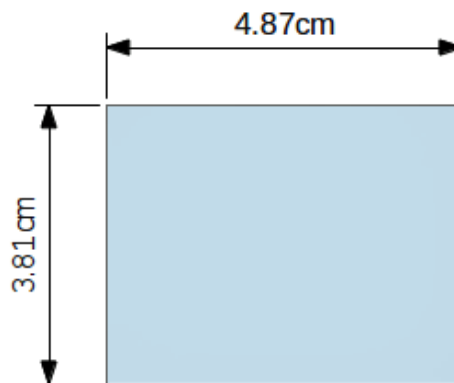



Figure 8: Dimensioning objects

- 1) Click on the small triangle next to the **Lines and Arrows** icon  on the Drawing toolbar to open the **Arrows** pop-up toolbar. Note that this icon changes depending on the last **Lines and Arrows** tool used. Also, this toolbar can become a floating toolbar by clicking on the bottom of the pop-up toolbar and dragging it into your workspace.
- 2) Click on the **Dimension Line** icon  on the **Arrows** toolbar and the cursor normally changes to a cross.
- 3) Position the cursor at one corner of your object, then click and drag the cursor to the other corner of your object to draw the dimension line. To restrict your dimension line to the horizontal or vertical direction, press and hold the *Shift* key while dragging the cursor.
- 4) Release the mouse button when you reach the other corner of your object and the dimension line is drawn with the dimension automatically added. The dimension line is also placed automatically on the **Dimension Lines** layer; see “Default layers” on page 8 for more information.
- 5) If you want to edit the text of the dimension, double-click on an unselected dimension line to enter text edit mode and make your changes. Click outside the dimension line to save the changes.
- 6) If you want to configure your dimension line, see “Configuring dimensioning” on page 11.

## Drawing to scale

In Draw a drawing is made on a predefined drawing area. This is normally Letter or A4 page size depending on your locale, computer setup and the default printer connected to your computer. However, depending on the actual size of the drawn objects, it is often convenient to reduce or enlarge the drawing by scaling (for example 1:10 or 2:1).

You can specify a scale value by going to **Tools > Options > LibreOffice Draw > General** and selecting a value from the *Drawing scale* drop-down list. The default setting for this option is 1:1. When you make a change to the drawing scale, it is reflected in the rulers at the top and left side of your drawing.

Changes in the drawing scale have no effect on the basic drawing operations. Draw automatically calculates the necessary values (for example, dimension lines). The spacing of the grid points is independent of drawing scale, as the grid is an optical drawing aid and not a drawing element.

An increase in scale (for example 1:4) allows you to draw objects that would not fit into the paper size for your drawing. A decrease in drawing scale (for example 4:1) allows you to draw small objects accurately at an increased size to make them easier to understand.

- An example of drawing to scale is shown in Figure 9. All three rectangles are the same size.
- The left rectangle was drawn at the default 1:1 scale and dimensioned.
- The drawing scale was then changed to 1:4 and the dimensions were automatically increased by Draw to reflect the decrease in scale for the center rectangle.
- The drawing scale was then changed to 4:1 and the dimensions were automatically decreased by Draw to reflect the increase in scale for the right rectangle.

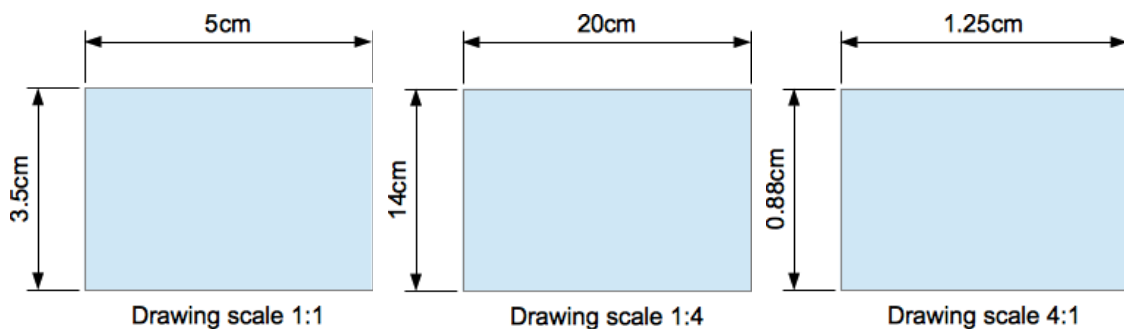

Figure 9: Examples of drawing to scale

## Gallery images

Draw includes several images in a **Gallery** which are grouped in themes: *Bullets*; *Rulers*; *Homepage*; *Rulers*; *Sounds*. The left pane of the gallery window lists the available themes. Click on a theme to see its images displayed in the right pane of the **Gallery** dialog (Figure 10).

The default themes are read only; no images can be added to or deleted from these themes. The default themes are easily recognizable by right-clicking on each category and the only available option in the pop-up menu is **Properties**.

In a default installation of LibreOffice, the *My themes* is the only category that is customizable and allows you add or delete your own graphics. You can also create new theme categories where you can add or delete your own images and this is explained in “Adding a new theme” on page 16.

## Using the Gallery

- 1) Click on the **Gallery** icon  on the Drawing toolbar or go to **Tools > Gallery** on the main menu bar to open the **Gallery** dialog.
- 2) Choose a theme in the left pane of the Gallery dialog.
- 3) Click on an image in the right pane of the Gallery dialog and drag the image into your drawing.

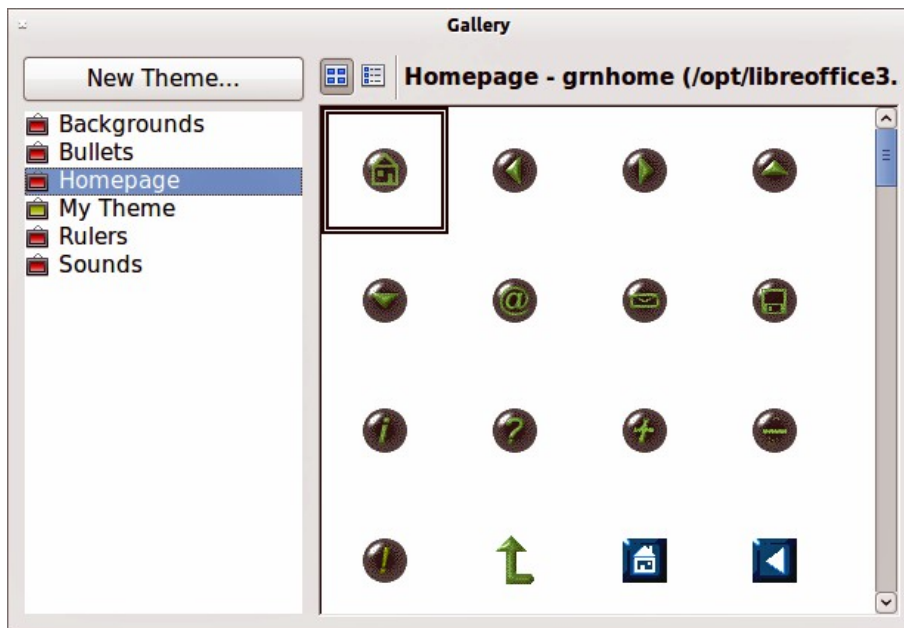

Figure 10. Gallery dialog

- 4) Alternatively, right-click on a gallery image and select **Insert > Copy** from the context menu.
- 5) Move to your drawing and paste the gallery image into your drawing.

## Adding images to My themes

You can add images only to *My themes* or themes that you have created.

- 1) Right-click on *My themes* or a theme name that you created in the list of theme categories and choose **Properties** from the pop-up menu to open the **Properties of My Theme** dialog (Figure 11).

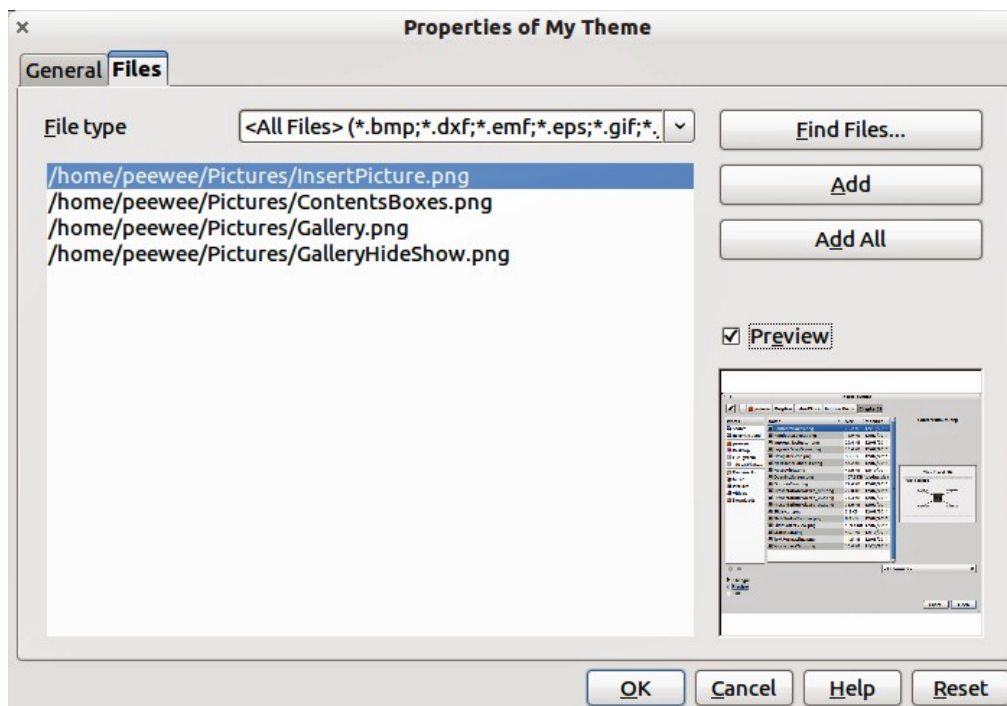

Figure 11. Properties of My Theme dialog

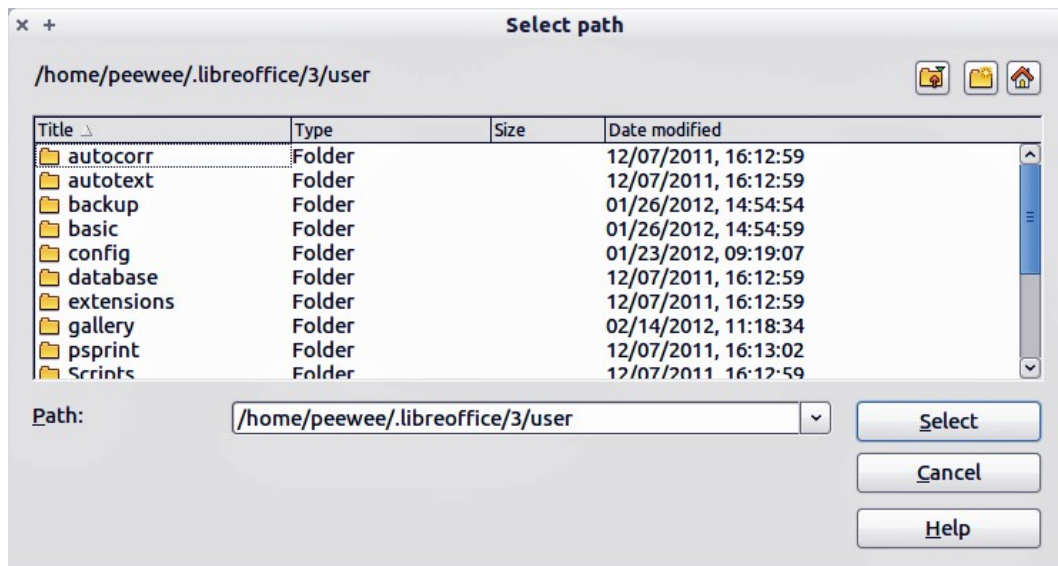

Figure 12. Selecting path for new images in themes

- 2) Click on the **Files** tab.
- 3) Click on **Find Files** to open the **Select Path** dialog (Figure 12).
- 4) Browse to the folder that contains the images you want to use.
- 5) Click **OK** to select the files contained in the folder and the **Select Path** dialog closes. The list of files contained in the folder now appear in the Theme Properties dialog.
- 6) Select the files you want to use in *My themes* and click on **Add**. The added files will disappear from the file list and the images will appear in the Gallery.
- 7) If you want to add all the files in the list, then click on **Add All**. All the files will disappear from the list and the images will appear in the Gallery.
- 8) Click **OK** when finished and the **Properties of My Theme** dialog will close.

## Deleting graphics

You can delete images only from *My themes* or themes that you have created.

- 1) Right-click on the image in the Gallery window.
- 2) Choose **Delete** from the pop-up menu.
- 3) A confirmation message appears, asking if you want to delete this object. Click **Yes**.

### Note

The image is a linked file and is deleted from the Gallery only. The original image file is not deleted.

All the images in a gallery are linked files. From time to time it is beneficial to update the gallery theme to make sure that all the files are still there. To do so, right-click on the theme where you added at least one file and then select **Update** from the pop-up menu.

## Adding a new theme

You can add a new theme to the list of theme categories in the gallery as follows:

- 1) Click the **New Theme** button above the list of theme categories and the Properties dialog opens.
- 2) Click the **General** tab and type a name for the new theme in the text box (Figure 13).



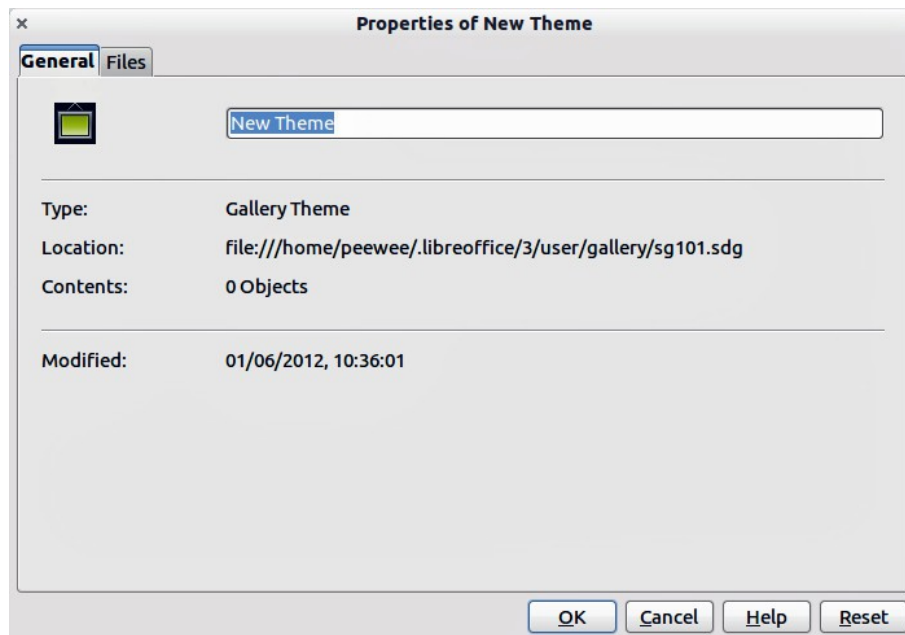

Figure 13. Adding new theme to the Gallery

- 3) Click the **Files** tab and follow Steps 3 through to 8 in “Adding images to My themes” on page 15.
- 4) The new theme will now be displayed in the list of theme categories in the Gallery.

#### Note

If you wish, you can rename this new theme by manually by right-clicking the theme name and selecting **Rename**.

## Colors and color palettes

Draw (like all LibreOffice components) uses color palettes for the representation of colors. Also, you can customize the color palette to suit your own needs by modifying colors in a palette, adding other colors, or creating new color palettes.

#### Note

LibreOffice uses the RGB color model internally for printing in all of its software modules. The CMYK controls are provided only to ease the input of color values using CMYK notation.

## Using colors

Two color dialogs are available where you can select, add, modify, edit or delete colors. Go to **Tools > Options > LibreOffice > Colors** (Figure 14) or **Format > Area > Colors** (Figure 15) on the main menu bar to open these color dialogs. Also, if you right-click on a selected object and go to **Area** in the context menu, then click on the **Colors** tab, you will open the **Area** dialog in Figure 15.

Color values are numeric and can be input directly as numbers. The color values for the RGB color model (Red, Green and Blue) can be any integer value between 0 and 255. The color values for the CMYK color model (Cyan, Magenta, Yellow and Black (K)) are percentages. When selecting between the RGB and CMYK color models, the value boxes automatically change in both dialogs to show RGB or CMYK.

When using CMYK values, the conversion to RGB values used in LibreOffice is made automatically. Any modifications made to colors apply only to the active palette in your drawing unless you save the modified color palette for future use.

**Tip**

For more information about color models, go to [http://en.wikipedia.org/wiki/Color\\_model](http://en.wikipedia.org/wiki/Color_model)

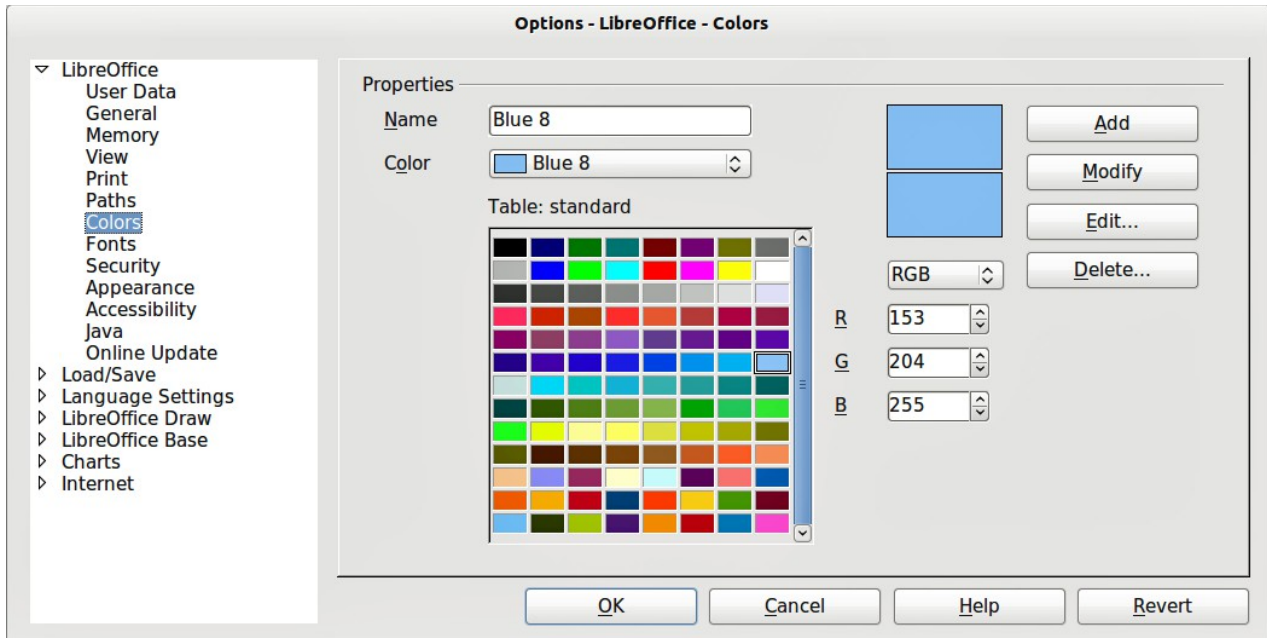

Figure 14: Options LibreOffice Colors dialog

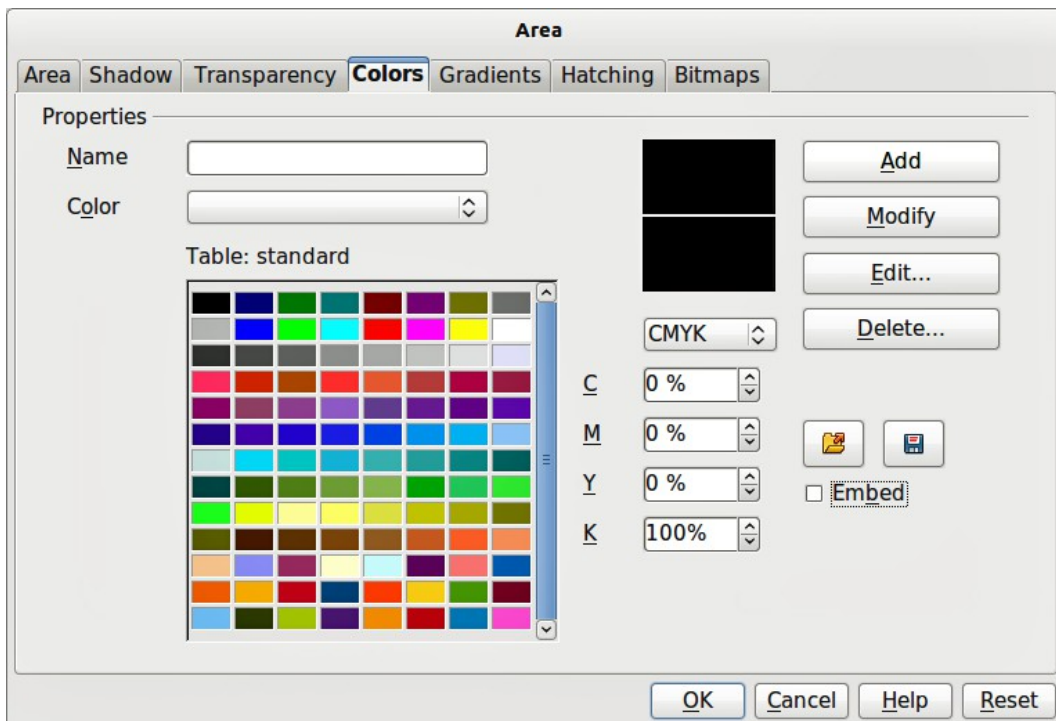



Figure 15: Format Area Colors dialog

## Selecting colors

- 1) Go to **Tools > Options > LibreOffice > Colors** (Figure 14) or **Format > Area > Colors** (Figure 15) on the main menu bar to open a color dialog.
- 2) Alternatively, right-click on a selected object and select **Area** from the context menu, then click on the **Colors** tab to open the color dialog (Figure 15).
- 3) Select a color from the *Color* drop down list, or select a color from the color table, or enter the RGB or CMYK values if you know these values for the color you want to use.
- 4) Click **OK** to use the selected color and close the dialog.

## Color palettes

The **Format > Area Colors** dialog (Figure 15) allows you to load color palettes, and to create and save color palettes for future use.

- Click on the Load Color List icon  to open a dialog where you can select a color palette to use in Draw.
- If you have made any changes to the color palette, click on the Save Color List icon  to open a dialog where you can save your color palette for future use in Draw. The file format used in LibreOffice for color palettes is .soc.

### Note

The **Load Color List** and **Save Color List** icons are only available if you select the color dialog using the **Format > Area > Colors** command or right-clicking on a selected object and selecting **Area** from the context menu.

## Creating colors

### Using color values

- 1) Select either RGB or CMYK from the drop down options on the color dialog.
- 2) Enter integer values or percentage values in each of the RGB or CMYK boxes or use the spinners at the right of each box.
- 3) The original color is shown in the top color sample and the new color is shown in the lower color sample.
- 4) Click **Modify** to apply and store the new setting in the color palette without changing the color name. Alternatively click **Add** and you will be prompted to give the color a new name. Entering a name and clicking **OK** will add the new color to the end of the color list and store it in the currently active palette.,
- 5) Click **OK** to use the modified or new color and close the dialog.

### Note

To store your new color in a color palette for future use in Draw, see “Color palettes” on page 19.

### Using the color picker

You can define colors using the **Color Picker** dialog (Figure 16).

- 1) Go to **Format > Area > Colors** on the main menu bar or right-click on a selected object and go to **Area** in the context menu to open the **Area** dialog and then click on the **Colors** tab to open the colors dialog (Figure 15).

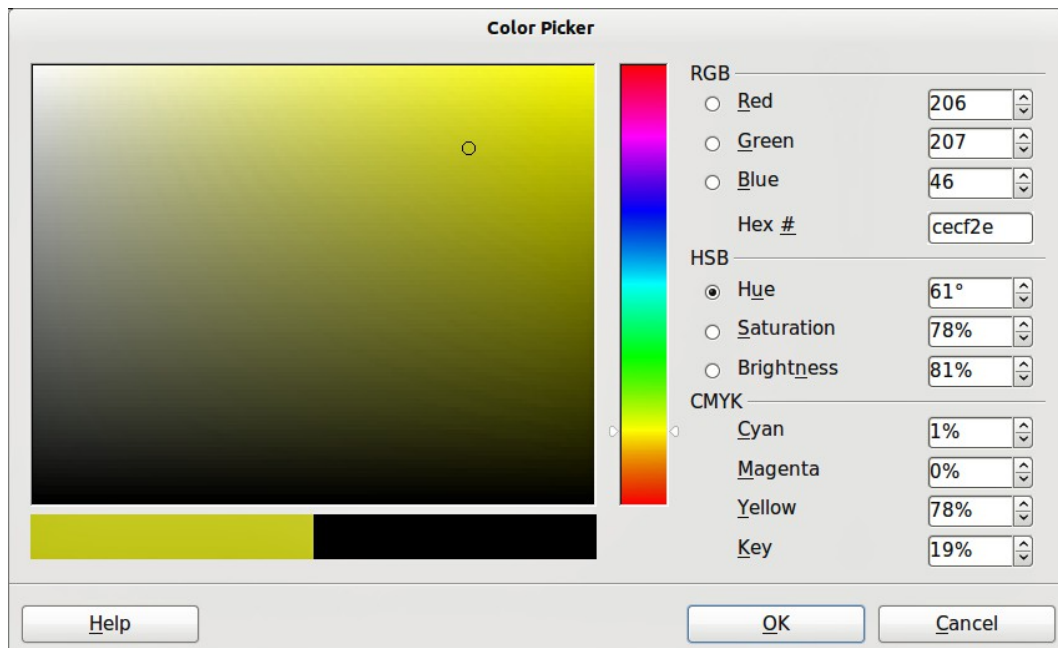

Figure 16: Color Picker dialog

- 2) Click **Edit** to open the **Color Picker** dialog, where you have three ways of selecting a color to create and use.
  - Click on the colored bar to the right of the color sample area to select a color. The values in the RGB, HSB (Hue, Saturation and Brightness) and CMYK boxes will change.
  - Or enter values in either the RGB, HSB or CMYK boxes to create the color. Entering values in one set of value boxes will change the values in the other two sets of boxes.
  - Or click on the small circle in the color sample area and drag it to a new position to create a new color.
- 3) The color bar below the sample color area will show the new color on the left half of this bar so that you can compare it with the original color on the right half of this bar.
- 4) If you are satisfied with the color created, click **OK** to use the color.
- 5) See “Using color values” on page 19 to save the color.

## Deleting colors

- 1) To delete a color from a color palette, open the color dialog (Figure 14 or Figure 15).
- 2) Select the color from the **Color** drop down list or the color table and click **Delete**.
- 3) Click **Yes** to confirm the deletion of the color.
- 4) Click **OK** to close the color dialog.

## Bézier curves

In LibreOffice you can use Bézier curves in your drawing. A curve is defined by means of a start point  $P_0$ , an end point  $P_3$ , and two control points  $P_1$  and  $P_2$  (Figure 17). For points on the curve, the terms *nodes* or *anchors* are often used. For the mathematical background of Bézier curves, see [http://en.wikipedia.org/wiki/Bezier\\_curve](http://en.wikipedia.org/wiki/Bezier_curve).

Bézier curves are very useful for experimenting with the shape and form of curves. In point mode you can change the curve alignment by dragging the points with the mouse. The curve leaves the start point  $P_0$  in the direction of the control point  $P_1$  and arrives at the end point  $P_3$  from the direction of the control point  $P_2$ . The more distant a control is from its start or end point the smaller

the curvature at that point. If a control point lies directly on one of these points, it has no influence on the curve.

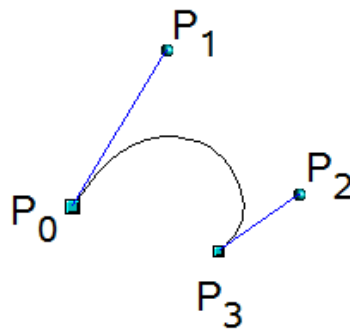

Figure 17: Points in Bézier curves

## Drawing a Bézier curve



- 1) Click on the small triangle to the right of the **Curve** icon  on the **Drawing** toolbar to open the **Lines** toolbar (Figure 18). The **Curve** icon will show the last tool selected from the **Lines** toolbar. To make this toolbar a floating toolbar, click at the bottom of the pop-up toolbar and drag it onto your workspace.



Figure 18: Lines toolbar

- 2) Click on the **Curve** icon  on the **Lines** toolbar. Note that this may be a different icon to the **Curve** icon on the **Drawing** toolbar.
- 3) Click at the start point where you want to draw the curve and, keeping the mouse button pressed, drag the cursor to the approximate position of the end point for the curve.
- 4) Double-click when you have reached the end position of your curve and a curve is drawn. The arc of the curve is determined by the distance you have dragged to create the end point.

### Note

If you single-click when you have reached the end point of your curve, you will continue drawing straight lines until you double-click to end the drawing of a curve.

- 5) Click on the **Points** icon  on the Drawing toolbar or press the *F8* key to open the **Edit Points** toolbar (Figure 19).
- 6) Click once on your curve to display the start and end points. The colored square marking the start point of the curve is larger than the one at the end point.
- 7) Move the cursor over the start or end point and drag it to the position where you want the control point to be. The control point appears at the end of a dashed line connected to the point you have selected (Figure 21).
- 8) When you have the correct position, release the cursor and the control point remains active.
- 9) Click on the control point and drag it to change the shape of the curve.
- 10) When you have finished editing your curve, click anywhere on your workspace to deselect the curve and stop editing points.



Figure 19: Edit Points toolbar

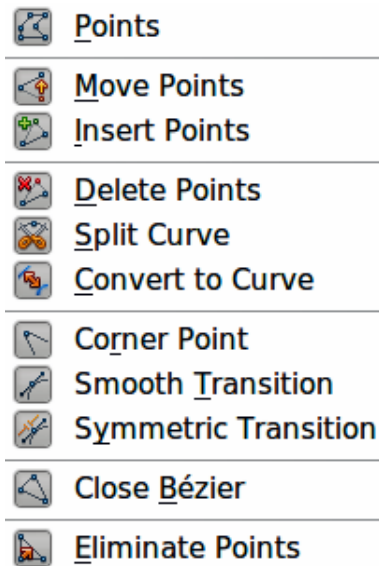

Figure 20: Edit Points tools

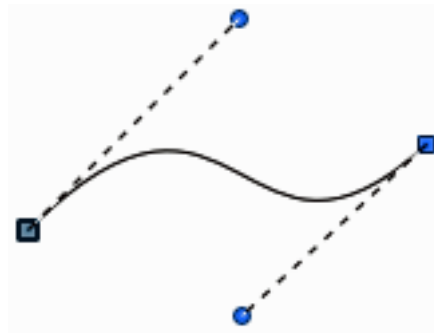

Figure 21: Control points on a curve

## Edit Points tools

The tools available on the **Edit Points** toolbar (Figure 19 and Figure 20), allow you to edit and change the shape of a Bézier curve:

- **Points** – allows you to activate or deactivate the edit mode for Bézier objects. In the edit mode, individual points of the drawing object can be selected.
- **Move Points** – activates a mode in which you can move points. The mouse pointer displays a small empty square when resting on a point. Drag that point to another location. The curve on both sides of the point follows the movement; the section of the curve between points changes shape. Point at the curve between two points or within a closed curve and drag the mouse to shift the entire curve without distorting the form.
- **Insert Points** – activates the insert mode and allows you to insert points. You can also move points, just as in the move mode. If, however, you click at the curve between two points and move the mouse a little while holding down the mouse button you insert a new point. The point is a smooth point, and the lines to the control points are parallel and remain so when moved. If you wish to create a corner point you must first insert either a smooth or a symmetrical point which is then converted to a corner point by using **Corner Point**.

- **Delete Points** – used to delete one or several selected points. If you wish to select several points, click the appropriate points while holding down the *Shift* key. First select the points to be deleted, and then click this icon or press *Delete* key.
- **Split Curve** – this tool splits a curve. Select the point or points where you want to split the curve, then click.
- **Convert To Curve** – converts a curve into a straight line or a straight line into a curve. If you select a single point, the portion of the curve before the point will be converted. If two points are selected, the curve between both points will be converted. If you select more than two points, each time you click this icon, a different portion of the curve will be converted. If necessary, round points are converted into corner points and corner points are converted into round points. If a section of the curve is straight, the end points of the line have a maximum of one control point each. They cannot be modified to control points unless the straight line is converted back to a curve.
- **Corner Point** – converts the selected point or points into corner points (Figure 22). Corner points have two movable control points, which are independent of each other. A curved line does not go straight through a corner point, but forms a corner.

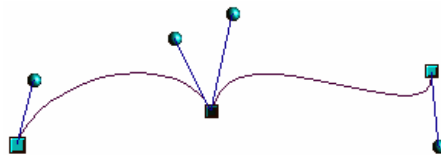

Figure 22: Corner point

- **Smooth Transition** – converts a corner point or symmetrical point into a smooth point (Figure 23). Both control points of the corner point are aligned in parallel and always move simultaneously. The control points may be different in length, allowing you to vary the degree of curvature.

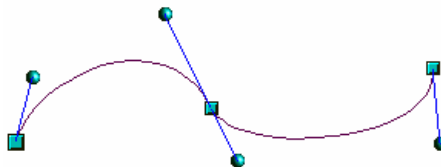

Figure 23: Smooth transition point

- **Symmetric Transition** – converts a corner point or a smooth point into a symmetrical point (Figure 24). Both control points of the corner point are aligned in parallel and have the same length. They can only be moved simultaneously and the degree of curvature is the same in both directions.

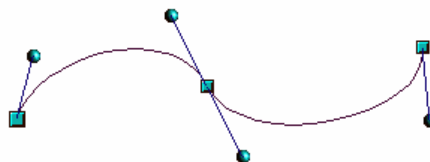

Figure 24: Symmetric transition point

- **Close Bézier** – closes a line or a curve. A line is closed by connecting the last point with the first point, indicated by an enlarged square.
- **Eliminate Points** – marks the current point or the selected points for deletion. This happens in the event that the point is located on a straight line. If you convert a curve or a

polygon with the **Convert to Curve** tool into a straight line or you change a curve with the mouse so that a point lies on the straight line, it is removed. The angle from which the point reduction is to take place can be set by going to **Tools > Options > LibreOffice Draw > Grid**.

## Adding comments to a drawing

---

Draw supports comments similar to those in Writer and Calc.

- 1) Go to **Insert > Comment** in the main menu bar. A comment box appears with a small marker box containing your initials in the upper left-hand corner of your drawing. Draw automatically adds your name and the date at the bottom of the comment (Figure 25).
- 2) Type or paste your comment into the text box.
- 3) To apply basic formatting to the text, right-click and select the formatting option from the context menu.
- 4) To delete a comment, right-click on the comment or marker box and select an option from the context menu or click on the small triangle in the bottom right of the comment and select an option from the context menu.
- 5) To move a comment, click on the small marker box and drag it to a new position on your drawing.
- 6) To show or hide the comments, go to **View > Comments**.



Figure 25: Comment in a drawing

### Note

For your initials and name to appear in a comment, you have to enter your user data. Go to **Tools > Options > LibreOffice > User Data** and enter all the necessary data. If more than one person edits the document, each author is automatically allocated a different background color.

## Connecting and breaking lines

---

It is possible in Draw to connect separate line elements together making one line, or break a line that has been created from separate elements.

Select a number of lines and go to **Modify > Connect**. The lines are converted to curves and adjacent end points are joined together. The resulting shape is a polyline, not a closed shape.

Select a line that is composed of separate elements and go to **Modify > Break**. Each separate element is now indicated with start and end points. Click on an element and drag it to a new position.