

LibreOffice
Community

LibreOffice Documentation Team

Draw Guide



7.2

LibreOffice is a registered trademark of The Document Foundation
Further Information is available at libreoffice.org

Copyright

This document is Copyright © 2022 by the LibreOffice Documentation Team. Contributors are listed below. This document maybe distributed and/or modify it under the terms of either the GNU General Public License (<https://www.gnu.org/licenses/gpl.html>), version 3 or later, or the Creative Commons Attribution License (<https://creativecommons.org/licenses/by/4.0/>), version 4.0 or later.

All trademarks within this guide belong to their legitimate owners.

Contributors

To this edition

Peter Schofield

To previous editions

Jean Hollis Weber

Martin Fox

Vipul Gupta

Regina Henschel

Winston Min Tjong

T. Elliot Turner

Peter Schofield

John Cleland

Kees Kriek

Dave Barton

Martin Saffron

Ron Faile Jr.

Elzett Kotze

John A Smith

Claire Wood

Hazel Russman

Low Song Chuan

Feedback

Please direct any comments or suggestions about this document to the Documentation Team's mailing list: documentation@global.libreoffice.org



Note

Everything sent to a mailing list, including email addresses and any other personal information that is written in the message, is publicly archived and cannot be deleted.

Publication date and software version

Published January 2022. Based on LibreOffice 7.2 Community.

Other versions of LibreOffice may differ in appearance and functionality.

Contents

Copyright.....	2
Preface.....	6
Who is this user guide for?.....	7
What is in this user guide?.....	7
Minimum requirements for using LibreOffice.....	7
How to get LibreOffice.....	7
Installing LibreOffice.....	7
Setting up and customizing LibreOffice.....	7
Extensions and add-ons.....	8
Where to get more help.....	8
What you see may be different.....	10
Using LibreOffice on macOS.....	11
Who wrote this user guide?.....	12
Frequently asked questions.....	12
What is new in LibreOffice 7.2?.....	13
Chapter 1, Introducing Draw.....	14
Introduction.....	15
Draw main window.....	16
Choosing and defining colors.....	22
Grid, snap guides, and helplines.....	23
Chapter 2, Drawing Basic Shapes.....	24
Introduction.....	25
Drawing basic shapes.....	25
Glue points and connectors.....	36
Drawing geometric shapes.....	37
Adding, inserting and formatting text.....	39
Chapter 3, Working with Objects.....	40
Introduction.....	41
Selecting objects.....	41
Positioning and adjusting objects.....	42
Using grid and snap functions.....	51
Using Helplines.....	56
Changing object shape.....	57
Chapter 4, Changing Object Attributes.....	69
Formatting lines.....	70
Formatting area fills.....	78
Working with area fills.....	81
Working with shadows.....	96
Working with transparencies.....	98
Drawing styles.....	99
Special effects.....	104

Chapter 5, Combining Multiple Objects.....	111
Grouping objects.....	112
Combining, splitting, breaking, and connecting.....	114
Merging, subtracting, or intersecting objects.....	116
Duplication and cross-fading.....	118
Positioning objects.....	121
Chapter 6, Editing Images.....	124
Introduction.....	125
Importing images.....	125
Exporting graphics.....	129
Formatting images (raster objects).....	130
Cropping images.....	133
Image filters.....	137
Replacing colors.....	142
Conversion.....	145
Chapter 7, Working with 3D Objects.....	148
Introduction.....	149
3D object types.....	150
Creating 3D objects.....	151
Editing 3D objects.....	154
Combining objects.....	165
Assembling 3D objects.....	166
Chapter 8, Connections, Flowcharts, and Organization Charts.....	168
Connectors and glue points.....	169
Flowcharts.....	178
Organization charts.....	179
Chapter 9, Adding and Formatting Text.....	181
Introduction.....	182
Text mode.....	182
Text boxes.....	183
Text in Draw objects.....	187
Pasting text.....	190
Formatting text.....	191
Bullet or numbered lists.....	203
Text columns.....	207
Using tables.....	209
Using fields.....	218
Using hyperlinks.....	219
Image maps.....	221
Fontwork.....	223
Chapter 10, Printing, Exporting and Emailing.....	226
Printing.....	227
Exporting.....	233

Emailing documents.....	235
Digital signatures.....	236
Removing personal data.....	236
Redaction.....	238
Chapter 11, Advanced Draw Techniques.....	240
Drawing pages.....	241
Master pages.....	244
Templates.....	249
Multiple layers.....	258
Dimensioning.....	262
Drawing to scale.....	266
Multiple views of a drawing.....	267
Gallery.....	268
Colors.....	270
Bézier curves.....	279
Adding comments to a drawing.....	282
Coordinate system.....	283
Chapter 12 User Interface Variants.....	285
Introduction.....	286
Selecting user interface.....	286
Standard Toolbar UI.....	287
Tabbed UI.....	287
Single Toolbar UI & Sidebar UI.....	297
Tabbed Compact UI.....	297
Groupedbar Compact UI.....	297
Contextual Single UI.....	298
Appendix A, Keyboard Shortcuts.....	299
Introduction.....	300
Draw function key and keyboard shortcuts.....	300
Menu function key and keyboard shortcuts.....	304
General function key and keyboard shortcuts.....	308
Toolbar function key and keyboard shortcuts.....	309
Appendix B, Toolbars.....	314
Introduction.....	315
Using toolbars.....	315
Toolbars.....	319



LibreOffice
Community



Draw Guide 7.2

Preface

Drawing Vector Graphics in LibreOffice

Who is this user guide for?

Anyone who wants to quickly acquire knowledge on LibreOffice Draw and is new to drawing software, or may be familiar with another office suite, will find this user guide very useful.

LibreOffice is an open-source office productivity software suite containing capabilities for word processing, spreadsheets, presentations, graphics, databases, and formula editing. LibreOffice Draw is the vector graphics drawing application for LibreOffice.

What is in this user guide?

This user guide introduces the main features of LibreOffice Draw. Although Draw is a vector graphics drawing tool, it can also perform some operations on raster graphics (pixels) such as photographs. Using Draw, a wide variety of graphical images can be quickly created.

A few examples of the drawing functions are: layer management, snap functions and grid-point system, dimensions and measurement display, connectors for making organization charts, 3D functions that enable small 3D drawings to be created (with texture and lighting effects), drawing and page-style integration, and Bézier curves.

The Draw Guide is not a course book to be worked through from beginning to end. Rather, it is a reference work which can be browsed for guidance on particular topics.

Minimum requirements for using LibreOffice

For a detailed list of requirements and operating systems supported, see the LibreOffice website, <https://www.libreoffice.org/get-help/system-requirements/>.

How to get LibreOffice

Versions of LibreOffice for Windows, Linux, and macOS are freely available and can be downloaded from <https://www.libreoffice.org/download>. Linux users will also find LibreOffice included free in many of the latest distributions.

Portable and other versions of LibreOffice are listed on the download page. Linux, Vanilla, and other versions may differ in a few features from the descriptions in this user guide.

Installing LibreOffice

Information on installing and setting up LibreOffice on the various supported operating systems is given here: <https://www.libreoffice.org/get-help/install-howto/>.

Setting up and customizing LibreOffice

To change the default settings (options) in LibreOffice to match the required preferences, go to **Tools > Options** on the Menu bar (**LibreOffice > Preferences** in macOS).

Tip

Some settings are intended for power users and programmers. If it is difficult to understand what an option does, LibreOffice recommends leaving the option on its default setting unless instructions in this user guide recommend changing the setting.

Settings are described in LibreOffice Help and the *Getting Started Guide*. These two sources provide information on how to customize menus, toolbars, and keyboard shortcuts in LibreOffice Draw, add new menus and toolbars, and assign macros to events.

Extensions and add-ons

Functionality can be added to LibreOffice with extensions and add-ons. Several extensions are installed with the program and other extensions from the official extensions repository, <https://extensions.libreoffice.org/> or from other sources. See the *Getting Started Guide* for more information on installing extensions and add-ons.

Where to get more help

This user guide and other LibreOffice user guides, the built-in Help system, and user support systems assume that users are familiar with computers and basic functions such as starting a program, opening and saving files.

Help system

LibreOffice comes with an extensive Help system and this can be used as the first line of support. Windows and Linux users can choose to download and install the offline Help for use when not connected to the Internet. Offline Help is installed with the MacOS version of LibreOffice.

To display the LibreOffice Help, press *F1* or go to **Help > LibreOffice Help** on the Menu bar. If the offline help is not installed on a computer, but is connected to the Internet, a dialog opens giving the option to **Read Help Online**. Select this option and the default web browser opens at the LibreOffice online help pages in the LibreOffice website.

The Help menu also includes links to other LibreOffice information and support facilities.

- **What's This?** – for quick tips when a toolbar is visible, place the mouse cursor over any of the tool icons to see a small tooltip box with a brief explanation of the tool function. Also **Extended Tips** can be activated by going to **Tools > Options > LibreOffice > General** on the Menu bar. **Extended Tips** provide a brief description about tools and commands. To display an extended tip, use the keyboard *Shift+F1*, then point to a tool or command.
- **User Guides** – opens the default browser at the Documentation page of the LibreOffice website <https://documentation.libreoffice.org/en/english-documentation/>. This page gives access to the LibreOffice User Guides and other useful information that can be opened in the default browser. Also, the User Guides are available in PDF format as a free download or to buy as printed copies.
- **Show Tip of the Day** – opens a small window with a random tip on how to use LibreOffice.
- **Get Help Online** – opens the default browser at the Ask LibreOffice forum of questions and answers from the LibreOffice community, <https://ask.libreoffice.org/en/questions/>.
- **Send Feedback** – opens the default browser at the Feedback page of the LibreOffice website <https://www.libreoffice.org/get-help/feedback/>. From this page, bugs can be reported, new features suggested and communicated with other users in the LibreOffice community.
- **Restart in Safe Mode** – opens a dialog window giving options to restart LibreOffice and reset the software to its default settings. Restarting in safe mode also provides an opportunity to restore LibreOffice from a backup.

- **Get Involved** – opens the default browser at the Get Involved page of the LibreOffice website, <https://www.libreoffice.org/community/get-involved/>. Choose a topic of interest to help improve the program.
- **Donate to LibreOffice** – opens the default browser at the Donation page of the LibreOffice website, <https://donate.libreoffice.org/> providing an opportunity to make a donation to support LibreOffice.
- **License Information** – outlines the licenses under which LibreOffice is made available.
- **Check for Updates** – opens a dialog and checks the LibreOffice website for updates to version of the software. The dialog provides an opportunity to download and install any updates to LibreOffice.
- **About LibreOffice** – opens a dialog and displays information about the version of LibreOffice and the operating system being used. This information is often requested if the community is asked for help or assistance with the software (on macOS, this option is found under **LibreOffice** on the Menu bar).

Other free online support

The LibreOffice community not only develops software, but provides free, volunteer-based support. See Table 1 and this web page: <https://www.libreoffice.org/get-help/> For comprehensive online support from the community, look at mailing lists and the Ask LibreOffice website, <https://ask.libreoffice.org/en/questions/>. Other user websites also offer free tips and tutorials.

Table 1: Free support for LibreOffice users

Free LibreOffice support	
FAQs	Answers to frequently asked questions https://wiki.documentfoundation.org/Faq
Mailing lists	Free community support is provided by a network of experienced users https://www.libreoffice.org/get-help/mailling-lists/
Questions & Answers and Knowledge Base	Free community assistance is provided in a Question & Answer formatted web service. Search similar topics or open a new one in https://ask.libreoffice.org/en/questions The service is available in several other languages; just replace /en/ with de, es, fr, ja, ko, nl, pt, tr, and many others in the web address above.
Native language support	The LibreOffice website in various languages https://www.libreoffice.org/community/nlc/ Mailing lists for native languages https://wiki.documentfoundation.org/Local_Mailing_Lists Information about social networking https://wiki.documentfoundation.org/Website/Web_Sites_services
Accessibility options	Information about available accessibility options. https://www.libreoffice.org/get-help/accessibility/
OpenOffice Forum	Another forum that provides support for LibreOffice, among other open source office suites. https://forum.openoffice.org/en/forum/

Paid support and training

Support and training is available through service contracts from a vendor or consulting firm specializing in LibreOffice. For information about certified professional support, see The Document Foundation website: <https://www.documentfoundation.org/gethelp/support/>.

What you see may be different

Illustrations

LibreOffice runs on Windows, Linux, and macOS operating systems, each of which has several versions and can be customized by users (fonts, colors, themes, window managers). The illustrations in this guide were taken from a variety of computers and operating systems. Therefore, some illustrations will not look exactly like what is seen on a computer display.

Also, some of the dialogs may differ because of the settings selected in LibreOffice. Either use dialogs from the computer system (default) or dialogs provided by LibreOffice.

To change to using LibreOffice dialogs:

- 1) On Linux and Windows operating systems, go to **Tools > Options > LibreOffice > General** on the Menu bar to open the dialog for general options.
- 2) On a Mac operating system, go to **LibreOffice > Preferences > General** on the Menu bar to open the dialog for general options.
- 3) Select *Use LibreOffice* dialogs in **Open/Save dialogs** to display the LibreOffice dialogs on a computer display, as shown in Figure 1.
- 4) Click **OK** to save the settings and close the dialog.

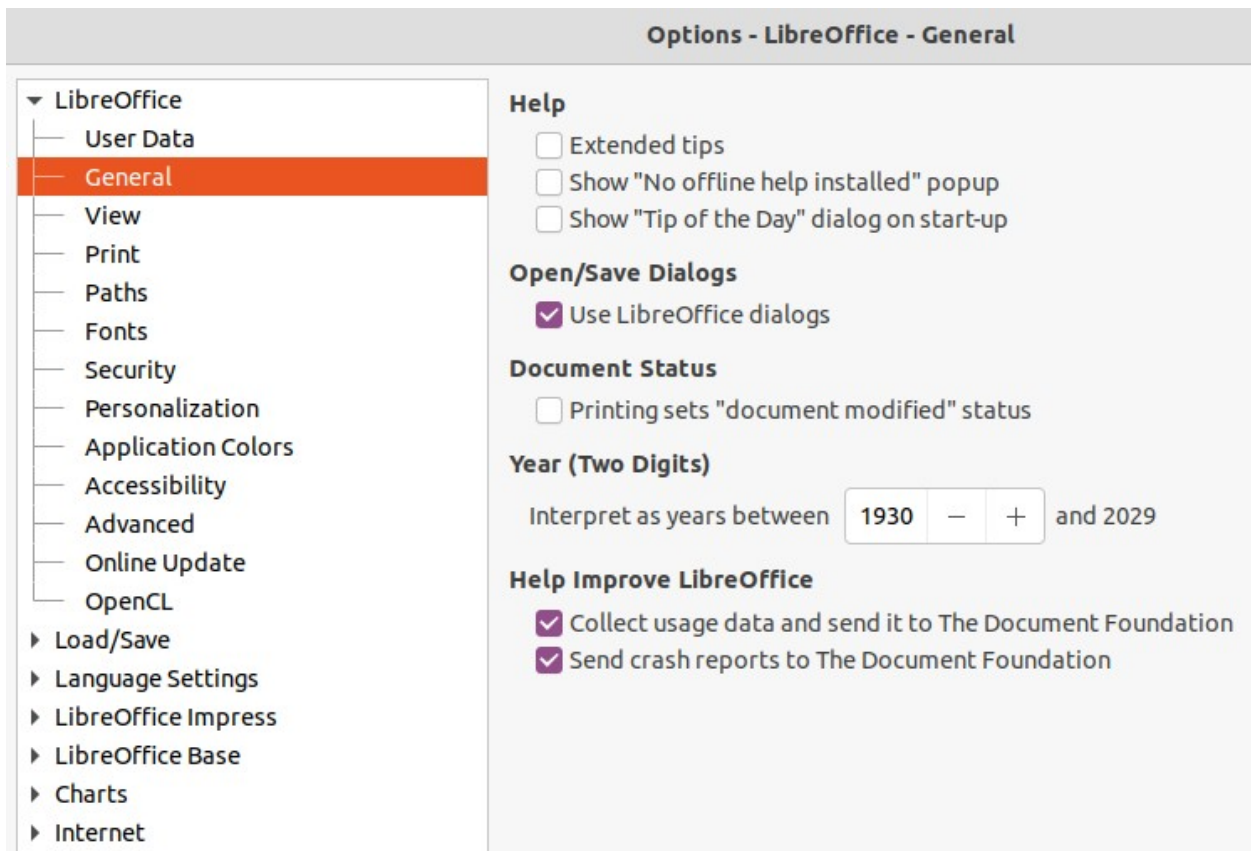

Figure 1: Options LibreOffice General dialog

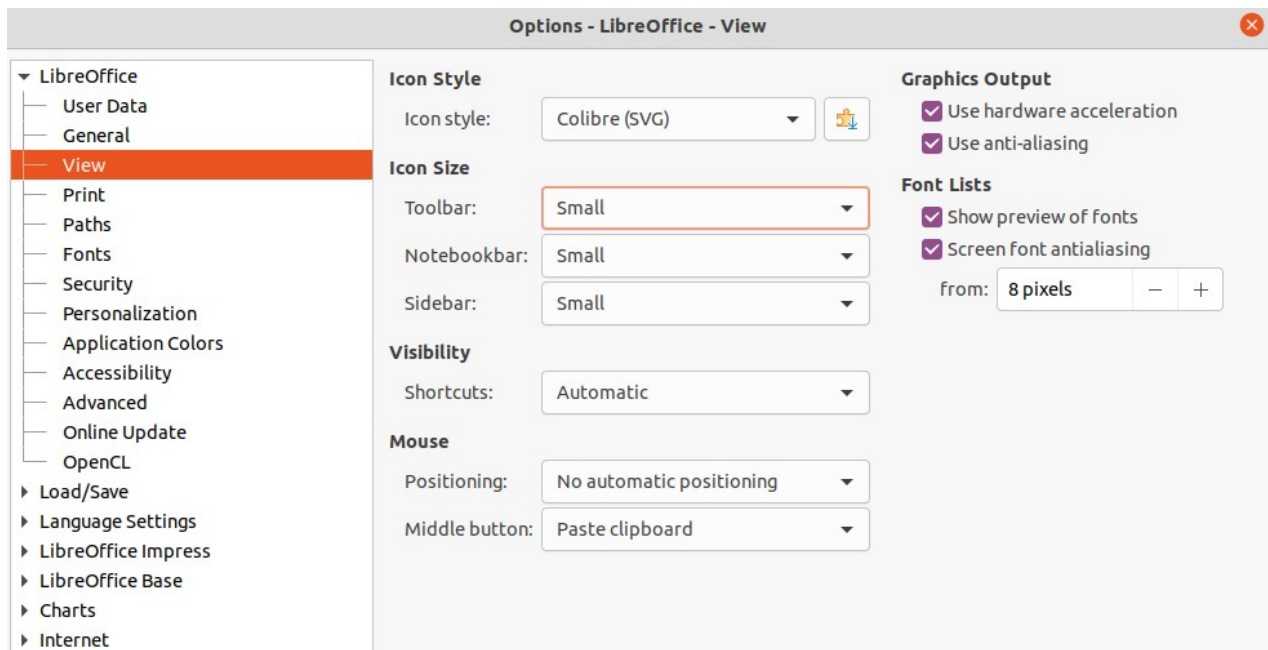

Figure 2: Options LibreOffice View dialog

Icons

The LibreOffice community has created icons for several icon sets, including Breeze, Colibre, Elementary, Sifr, and Tango. Each user can select a preferred set. The icons used to illustrate some of the many tools available in LibreOffice may differ from the ones used in this guide. The icons in this user guide have been taken from a LibreOffice installation that has been set to display the Colibre set of icons.

Change the icon set used in a LibreOffice installation as follows:

- 1) On Linux and Windows operating systems, go to **Tools > Options > LibreOffice > View** on the Menu bar to open the dialog for view options.
- 2) On a Mac operating system, go to **LibreOffice > Preferences > LibreOffice > View** on the Menu bar to open the dialog for view options.
- 3) In **Icon Style** select Colibre (SVG) from the options available in the drop down list as shown in Figure 2.
- 4) In **Icon Size**, select **Small** from the drop down lists for *Toolbar*, *Notebookbar* and *Sidebar*, as shown in Figure 2.
- 5) Click **OK** to save the settings and close the dialog.

Note

Some Linux operating systems, for example Ubuntu, include LibreOffice as part of the installation and may not include the Colibre icon set. This icon set can be downloaded from the software repository for the Linux operating system being used.

Using LibreOffice on macOS

Some keystrokes and menu items are different on macOS from those used in Windows and Linux. Table 2 below gives some common substitutions for the instructions in this user guide. For a more detailed list, see the application help.

Table 2: Example of macOS keyboard shortcuts

Windows or Linux	macOS equivalent	Effect
Tools > Options on Menu bar	LibreOffice > Preferences on Menu bar	Access setup options
Right-click	Ctrl +click and/or right-click depending on computer setup	Open a context menu
Ctrl (Control)	⌘ (Command)	Used with other keys
F11	⌘+T	Open the Styles deck in the Sidebar

Who wrote this user guide?

This user guide was written by volunteers from the LibreOffice community. Profits from sales of the printed edition will be used to benefit the community.

Frequently asked questions

How is LibreOffice licensed?

LibreOffice is distributed under the Open Source Initiative (OSI) approved Mozilla Public License (MPL). See <https://www.libreoffice.org/about-us/licenses/>. It is based on code from Apache OpenOffice made available under the Apache License 2.0 but also includes software that differs from version to version under a variety of other Open Source licenses. New code is available under LGPL 3.0 and MPL 2.0.

May I distribute LibreOffice to anyone?

Yes.

May I sell it?

Yes.

May I use it in my business?

Yes.

How many computers may I install it on?

As many as you like.

Is LibreOffice available in my language?

LibreOffice has been translated (localized) into over 40 languages, so your language probably is supported. Additionally, there are over 70 spelling, hyphenation, and thesaurus dictionaries available for languages, and dialects that do not have a localized program interface. The dictionaries are available from the LibreOffice website at: www.libreoffice.org.

How can you make it for free?

LibreOffice is developed and maintained by volunteers and has the backing of several organizations.

I am writing a software application. May I use programming code from LibreOffice in my program?

You may, within the parameters set in the MPL and/or LGPL. Read the licenses: <https://www.mozilla.org/MPL/2.0/>.

Why do I need Java to run LibreOffice? Is it written in Java?

LibreOffice is not written in Java; it is written in the C++ language. Java is one of several languages that can be used to extend the software. The Java JDK/JRE is only required for some features. The most notable one is the HSQLDB relational database engine. Java is available at no cost. More information and download links to the appropriate edition for your operating system can be found at: <https://java.com/en/download/manual.jsp>

Note

If the LibreOffice features that require Java are to be used, it is important that the correct 32-bit or 64-bit edition matches the installed version of LibreOffice. For more information, see the *Getting Started Guide*. If Java is not to be used, nearly all of the LibreOffice features can still be used.

How can I contribute to LibreOffice?

You can help with the development and user support of LibreOffice in many ways, and you do not need to be a programmer. To start, check out this webpage:
<https://www.libreoffice.org/community/get-involved/>

May I distribute the PDF of this user guide, or print and sell copies?

Yes, as long as requirements are met for one of the licenses in the copyright statement at the beginning of this user guide. There is no need to request special permission. LibreOffice request that you share with the project some of the profits you make from sales of user guides, in consideration of all the work we have put into producing them.

Donate to LibreOffice: <https://www.libreoffice.org/donate/>

What is new in LibreOffice 7.2?

The LibreOffice 7.2 Release Notes are available at this link
<https://wiki.documentfoundation.org/ReleaseNotes/7.2>

Also at this link, the release notes for earlier versions of LibreOffice are located giving more information on the features that are included in LibreOffice.



LibreOffice
Community



Draw Guide 7.2

Chapter 1, Introducing Draw

Introduction

LibreOffice Draw is a vector graphics drawing program, although it can also perform some operations on raster graphics (pixels). Using Draw, a wide variety of graphical images can easily and quickly be created.

Vector graphics store and display an image as an assembly of simple geometric elements such as lines, circles, and polygons, rather than a collection of pixels (points on the screen). Vector graphics allow for easier storage and scaling of the image.

Draw is fully integrated into the LibreOffice suite, and this simplifies exchanging graphics with all components of the LibreOffice suite. If an image is created in Draw, reusing it in a Writer document is relatively easy. For example, select and copy the drawing in Draw and then paste the image directly into a Writer document. Also, drawings can be worked on directly from within Writer or Impress, using a subset of the functions and tools from Draw.

The functionality of LibreOffice Draw is extensive. Draw was not designed to rival high-end graphics applications, but it possesses more functionality than the drawing tools that are generally integrated with the majority of office productivity suites.

A few examples of the drawing functions are: layer management, magnetic grid-point system, dimensions and measurement display, connectors for making organization charts, 3D functions that enable small three-dimensional drawings to be created (with texture and lighting effects), drawing and page-style integration, and Bézier curves.

This Draw Guide is not a course book to be worked through from beginning to end. Rather, it is a reference work in which can be browsed for guidance on particular topics.

This document describes only the functions associated with Draw. Some concepts, such as file management or the way the LibreOffice environment works, are mentioned only briefly and are covered in more detail in the *Getting Started Guide*.

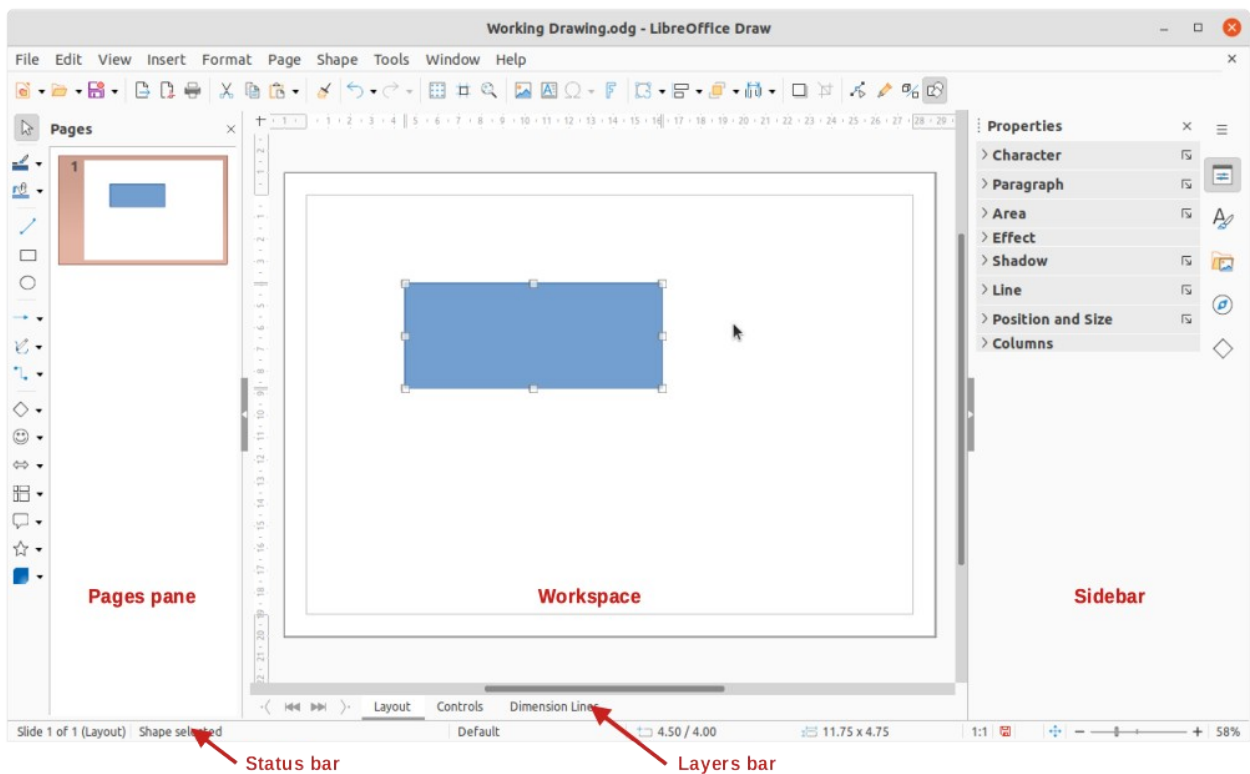

Figure 3: Draw main window

Draw main window

Workspace

The large area in the center of the Draw main window (Figure 3) is the Workspace where drawings are created. This drawing area can be surrounded with toolbars and information areas. The number and position of the visible tools vary with the task being carried out, user preferences, and computer setup.

The maximum size of a drawing page in LibreOffice Draw is limited by the computer setup and the page size that can be set and used in the printer connected to the computer.

Pages pane

In Draw, drawings can be split over several pages. Multi-page drawings are used mainly for presentations. The Pages pane, on the left side of the Draw main window, gives an overview of the pages that created in a drawing. If the Pages pane is not visible, go to **View > Page Pane** on the Menu bar. To make changes to the page order, drag and drop one or more pages displayed in the Pages pane.

Layers bar

By default, the Workspace consists of three layers (**Layout**, **Controls** and **Dimension Lines**) and the tabs for these default layers appear at the bottom of the Workspace. The default layers cannot be deleted or renamed, but layers can be added as and when necessary. A layer is a workspace where drawing elements and objects can be inserted.

Tabs for layers appear in the Layers bar at the bottom of the Workspace. The Layers bar allows for navigation between layers, adding layers as required, or deleting layers that have been created. For more information on layers, see Chapter 11, Advanced Draw Techniques.

Sidebar

The Sidebar has five main decks in Draw and is similar to the Sidebar in the other LibreOffice modules. To open a deck, click on its icon on the right of the Sidebar, or click on **Sidebar Settings** icon at the top of the tab bar and select a deck from the drop-down list. If the Sidebar is not visible, go to **View > Sidebar** on the Menu bar, or use the keyboard shortcut *Ctrl+F5*.

Properties

Contains panels for object properties, for example, *Character*, *Paragraph*, *Area*, *Effect*, *Shadow*, *Line*, *Position and Size* and *Columns*. The available panels depends on the object selected.

Styles

Provides options to edit and apply *Drawing Styles* to objects within a drawing. When a style is edited or modified, the changes are automatically applied to all of the elements formatted using that style. In Draw, *Presentation Styles* are not available.

Gallery

From the Gallery deck, objects can be inserted into a drawing either as a copy or as a link. The Gallery is divided into categories: *Arrows*, *BPMN* (Business Process Model and Notation), *Bullets*, *Diagrams*, *Flowchart*, *Icons*, *Network*, *Shapes*, and *Sounds*. See Chapter 11, Advanced Draw Techniques for more information on using the Gallery.

Navigator

On the Navigator deck, pages and objects in a drawing can be quickly selected. It is recommended to give pages and objects in a drawing meaningful names so that they are easily identified when using the Navigator.

Shapes

Provides quick selection of most items that are available on the Drawing toolbar: *Lines and Arrows, Curves and Polygons, Connectors, Basic Shapes, Symbol Shapes, Block Arrows, Flowchart, Callouts, Stars and Banners, and 3D Objects.*

Rulers

Rulers are positioned on the upper and left-hand sides of the Workspace. If they are not visible, go to **View > Rulers** in the Menu bar, or use the keyboard shortcut *Shift+Ctrl+R*. The rulers show the size of a selected object on the page using double lines (highlighted in Figure 4). Also, rulers can be used to manage object handles and guide lines when positioning objects.

The page margins in the drawing area are also represented on the rulers. Change the margins directly on the rulers by dragging them with the cursor. The margin areas are normally indicated by a grayed out area on the rulers as shown in Figure 4, but this does depend on computer operating system and setup.

To change the measurement units of the rulers, right-click on a ruler and select the measurement unit from the drop down list, as shown in Figure 5 for the horizontal ruler. Measurement units for the horizontal and vertical rulers can be set to different measurement units.

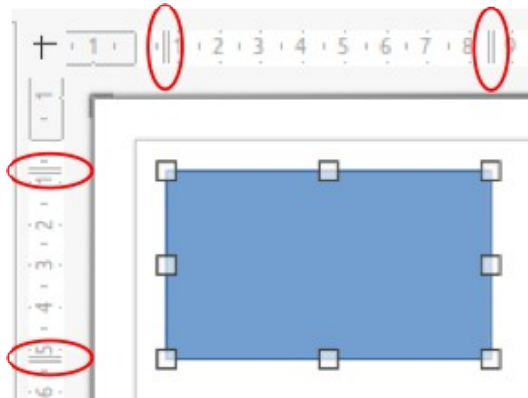

Figure 4: Rulers showing object size

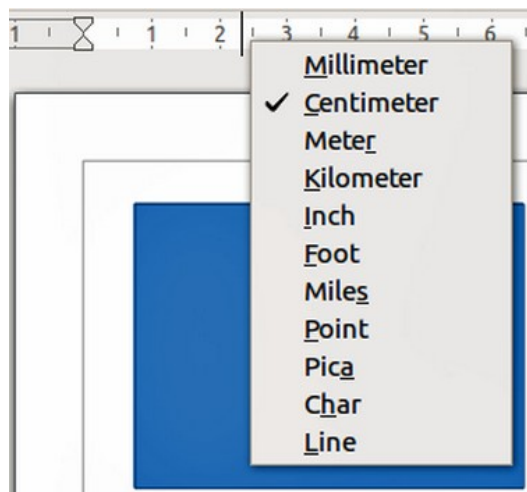

Figure 5: Ruler measurement units

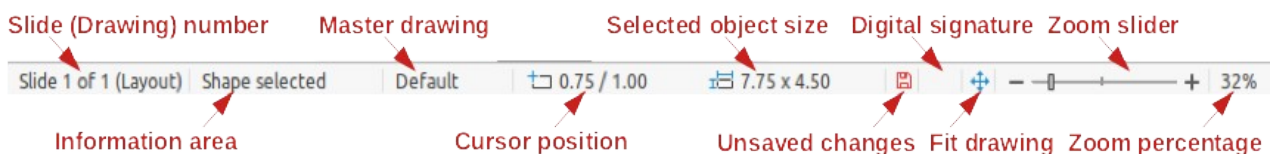

Figure 6: Status bar

Status bar

The Status Bar (Figure 6) is located at the bottom of the Workspace in all LibreOffice modules. To hide the Status Bar, go to **View** on the Menu bar and deselect **Status Bar**.

Note

The measurement units shown on the Status Bar are set by going to **Tools > Options > LibreOffice Draw > General** on the Menu bar. These measurement units can be different to the measurement units set for the rulers.

- **Slide number** – shows the number of the drawing pane that is selected.
- **Information area** – shows which action is being carried out, or object type selected.
- **Cursor position** and **Object size** – shows different information depending on whether objects are selected or not.
 - When no object is selected, the position numbers show the current position (X and Y coordinates) of the mouse cursor.
 - When an object is selected and being resized with the mouse, the object size numbers show the size of the object (width and height).
 - If an object is selected, the position numbers shows the X and Y coordinates of the upper-left corner and the object size number pair displays the size of the object. These numbers do not relate to the object itself, but to the selection outline, which is the smallest possible rectangle that can contain the visible part or parts of the object; see Chapter 3, Working with Objects and Object Points for more information.
 - When an object is selected, clicking in either of these areas opens the Position and Size dialog. See Chapter 4, Changing Object Attributes for more information.
- **Unsaved changes** – indicates that the file needs saving. The icon displayed depends on computer setup. Clicking on this icon opens the Save as dialog if the file is new and has not been saved before. If the file has been saved already, then clicking on this icon automatically saves the file after any changes have been made.
- **Digital signature** – indicates if the document is digitally signed. The icon only appears if the drawing has a digital signature certificate. After the file has been saved, double-clicking on this icon opens the digital signatures dialog. See LibreOffice Help for more information on digital signature certificates.
- **Fit drawing** – resizes the drawing so that the whole drawing appears in the Workspace.
- **Zoom slider** and **Zoom percentage** – adjusts and indicates the zoom percentage of the Workspace displayed. Double-clicking on zoom percentage opens the Zoom & View Layout dialog.

Toolbars

To display or hide the various Draw toolbars, go to **View > Toolbars** on the Menu bar and select from the drop down menu the toolbar required. For example, the Standard and Drawing toolbars are shown by default, but the Line and Filling, Text Formatting, and Options toolbars are not shown.

The appearance of the tool icons on toolbars depends on the computer operating system and the selection of icon style and size in **Tools > Options > LibreOffice > View**.

The tools available on a toolbar are indicated, either, by a shaded outline around the tool icon, or a check mark as shown by the example in Figure 7. For more information about working with toolbars, see the *Getting Started Guide*.

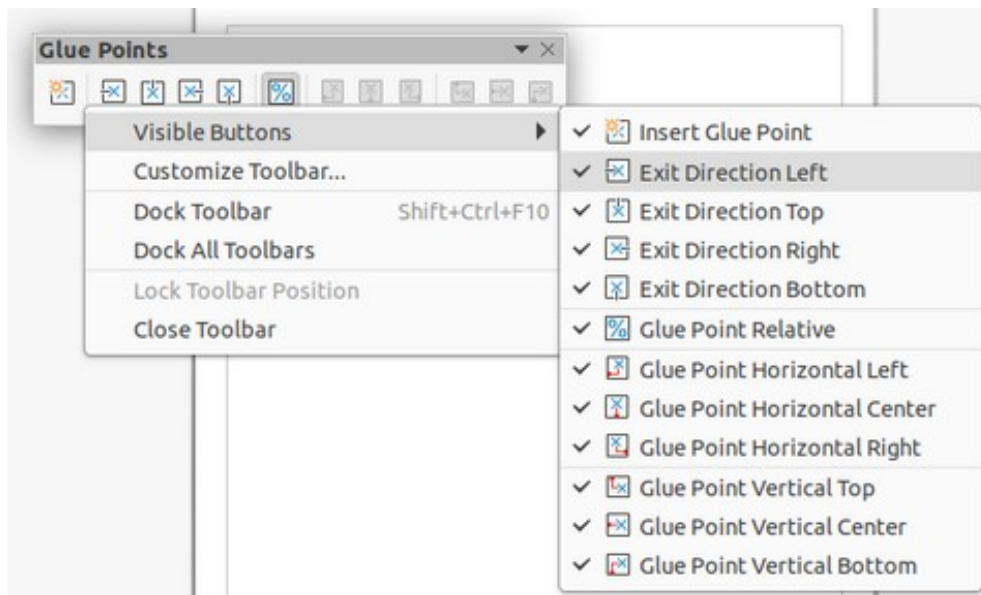

Figure 7: Visible buttons on a toolbar

The four main toolbars used in Draw are as follows:

Standard toolbar

The Standard toolbar (Figure 8) is the same for all LibreOffice components and is not described in detail in this chapter. By default, it is locked into position at the top of the Draw main window.

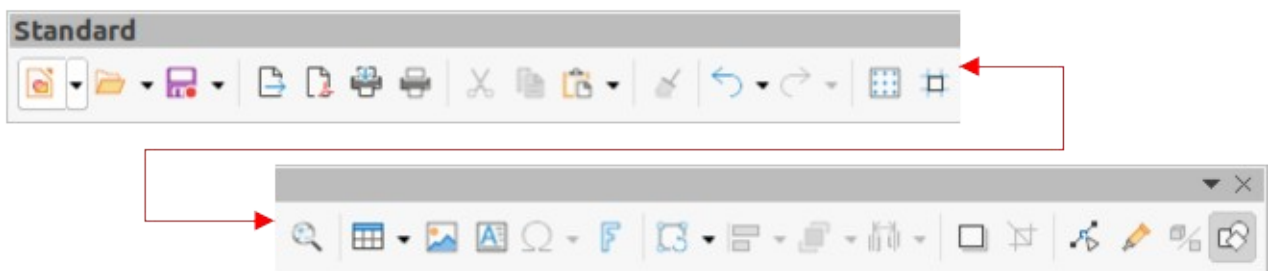

Figure 8: Standard toolbar

Drawing toolbar

The Drawing toolbar (Figure 9) contains all the necessary functions for drawing various geometric and freehand shapes, and for organizing them in the drawing. By default, it is locked into position on the left of the Draw main window. It is described in detail in Chapter 2, Drawing Basic Shapes.



Figure 9: Drawing toolbar

Line and Filling toolbar

The Line and Filling toolbar (Figure 10) is used to modify the main properties of a drawing object. The tools and pull-down lists vary according to the type of object selected. For example, to change the style of a line, click on the up and down arrows for **Line Style** and select the required style.

The functions on the Line and Filling toolbar are used to change the color, style, and width of the line drawn, the fill color and style, and other properties of a selected object. If the selected object is a text frame, the Line and Filling toolbar is replaced by the Text Formatting toolbar. For more information, see Chapter, 4 Changing Object Attributes.

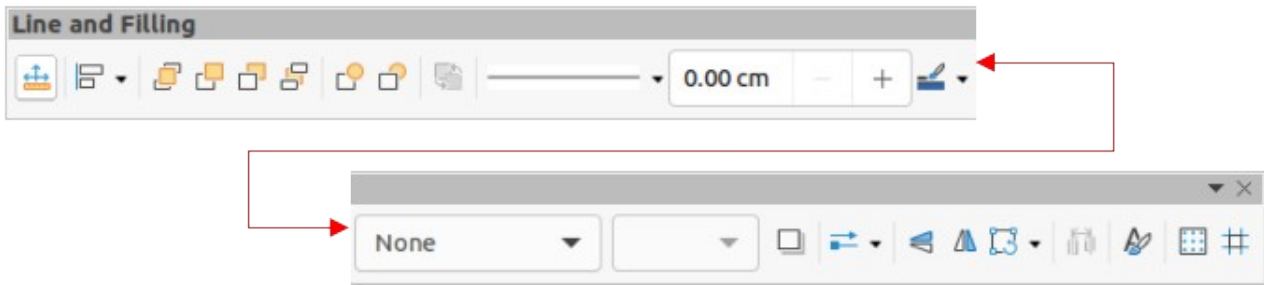

Figure 10: Line and Filling toolbar

Text Formatting toolbar

The Text Formatting toolbar (Figure 11) is similar to the Formatting toolbar in Writer. It is only available when text or a text object has been selected in a drawing, replacing the Line and Filling toolbar. For more information, see Chapter, 4 Changing Object Attributes, and Chapter 9 Adding and Formatting Text.



Figure 11: Text Formatting toolbar

Adding and removing tools

The default set of tools on each toolbar can be modified using **Visible Buttons**. Adding or removing a tool is as follows:

- 1) Either, right-click in an empty area on the toolbar, or click on the triangle ▼ in the toolbar title and select **Visible Buttons** from the context menu.
- 2) Click on a tool name to add or remove the tool.

✓ Note

For more information on the available tools that can be added to a toolbar, see Appendix B, Toolbars and the *Getting Started Guide*. When a tool is added to a toolbar, its position on the toolbar (from left to right) is the same as its position in the **Visible Buttons** context menu.

Available toolsets

Some tools on a toolbar have a triangle ▼ to the right side of the tool icon. This indicates that the tool has additional tools available. Click on this triangle ▼ to display the full set of tools (Figure 12).

This toolset can be turned into a floating toolbar. Click the area at the top of the toolset as shown in Figure 12, drag it across the screen to a convenient location and release the mouse button. To close a floating toolbar, click on the X on the right of the toolbar title.

✓ Note

When a toolset is made into a floating toolbar, the tool on the existing toolbar remains in the toolbar and always shows the last tool used. This means that the tool icon on a screen may differ from the tool icon shown in this guide.



Figure 12: Available toolsets

i Tip

When double-clicking on a tool, the command corresponding to that tool becomes active and remains active. The tool command can be repeated as often as required. To exit from this mode, press the *Esc* key or click on another tool. Please note that this may not work for every tool on every toolbar.

Docked and floating toolbars

When Draw is opened, the Standard and Drawing toolbars, by default, are already locked and docked into their positions on the main Draw window. These toolbars can be undocked creating floating toolbars as follows:

- 1) Move the mouse cursor to the far left of the toolbar and over the toolbar handle (Figure 13). The cursor changes shape, normally to a grabbing hand, depending on computer setup and operating system.
- 2) Click and drag on the toolbar handle to move the toolbar until it becomes a floating toolbar. This floating toolbar capability is common to all components of LibreOffice.

To dock a floating toolbar, press and hold the *Ctrl* key, then double click on the title of the toolbar. The toolbar moves into available space at the top of the Draw main window.

An alternative method of docking a toolbar is to click in the toolbar title and drag the toolbar to the docked position required. This can be the top, bottom or one of the sides of the Draw main window.

Unlocking and locking toolbars

By default when Draw is opened, any docked toolbars are locked into position and have to be unlocked before they can become floating toolbars or repositioned on the Draw main window.

To unlock a toolbar, right-click in a blank area on the toolbar and deselect **Lock Toolbar Position** from the context menu. A toolbar handle, as shown in Figure 13, appears at the left end of the toolbar, indicating that the toolbar is unlocked and can be moved.



Figure 13: Toolbar handles

To lock a toolbar into position, dock the toolbar into position, then right-click in a blank area on the toolbar and select **Lock Toolbar Position** from the context menu. The toolbar handle disappears from the left end of the toolbar.

Customizing toolbars

Draw toolbars can be customized by adding or removing commands to or from a toolbar. Also, customization allows the creation of toolbars for specific purposes. Customizing toolbars is in addition to using “Adding and removing tools” above.

For more information when adding a new commands, modifying toolbars, or creating toolbars, see Appendix B, Toolbars and the *Getting Started Guide*.

Choosing and defining colors

Color palette

The Color Palette (Figure 14) provides quick access to a standard set of colors to use for selected objects and text in a drawing.

- 1) Go to **View** on the Menu bar and select **Color Bar** to open the Color Palette.
- 2) Select an object or text.
- 3) Left click on the color required for the area fill or text and change the color of the object or text.
- 4) Right click on the color required for the object or text box border and change the color of the border.
- 5) Go to **View** on the Menu bar and deselect **Color Bar** to close the Color Palette.

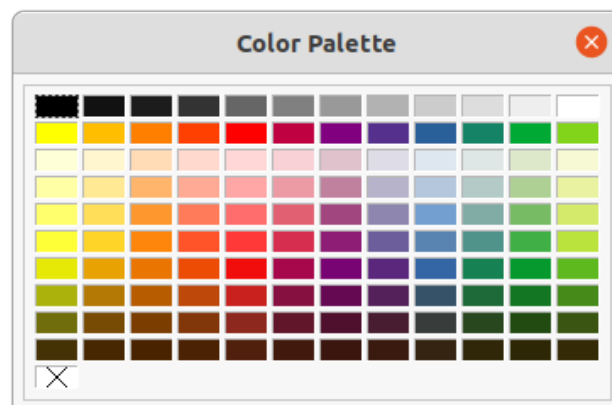

Figure 14: Color Palette (Color Bar)

✓ Note

The box with the X at the bottom left of the Color Palette corresponds to none (no color).

Specialized color palettes

In addition to the standard Color Palette, Draw has several specialized color palettes available, giving a greater choice of color: for example, chart-palettes, material, html, and so on. After selecting an object or text in a drawing, use one of the following to access the specialized color palettes.

- Area or fill color – **Color** page in the Area dialog, **Fill Color** on the Drawing or Line and Filling toolbar, or *Fill* in the **Area** section in the Properties deck on the Sidebar.

- Line color – **Line** page in the Line dialog, **Line Color** on the Drawing or Line and Filling toolbar, or *Color* in the **Line** section in the Properties deck on the Sidebar
- Text color – **Font Color** tool on the Text Formatting toolbar, or *Font Color* in the **Character** section in the Properties deck on the Sidebar.

For more information on selecting a color and a color palette for an object or text, see Chapter 4, Changing Object Attributes, Chapter 9, Adding and Formatting Text and Chapter 11, Advanced Draw Techniques.

Custom colors

In Draw, custom colors can be created using the Color Picker dialog, specific CMYK values, or specific RGB values to match the color schemes used in a company. For more detailed information on creating custom colors and color palettes, as well as more information on CMYK and RGB color schemes, refer to Chapter 11, Advanced Draw Techniques.

Grid, snap guides, and helplines

The grid, snap guides, and helplines in Draw act as drawing aids when moving and positioning objects in a drawing. These drawing aids can be turned on or off as follows:

- Line and Filling toolbar – click on **Display Grid** or **Helplines While Moving** to turn the grid or helplines on or off.
- Options toolbar – click on **Display Grid**, **Display Snap Guides**, or **Helplines While Moving** to turn the grid, snap guides, or helplines on or off.
- Go to **View > Grid and Helplines** on the Menu bar and select or deselect **Display Grid** or **Helplines While Moving** on the submenu.
- Go to **View > Snap Guides** on the Menu bar and select or deselect **Display Snap Guides** on the submenu.

The grid and snap guides are displayed only on the screen and are not shown on a printed drawing or when the drawing is used in another LibreOffice module. The color, spacing and resolution of the grid points can be individually chosen for each axis. Draw also offers several snap functions to position objects exactly in a drawing.

Helplines show the position of the object while moving and makes positioning an object much easier. If this function is activated, pairs of vertical and horizontal lines enclosing the object are shown while moving the object. These helplines extend to the edges of the drawing area.

For more information on the grid, snap guides, snap functions, and helplines, see Chapter 3, Working with Objects and Object Points.



LibreOffice
Community



Draw Guide 7.2

Chapter 2, Drawing Basic Shapes

Introduction

LibreOffice Draw can create 2D and 3D objects. This chapter shows how to draw simple 2D objects. The following chapters describe how to work with and edit such objects. For more information on 3D objects, see Chapter 7, Working with 3D Objects.

All shapes, whether they are lines, rectangles, or more complicated shapes, are called objects. This is common notation in vector drawing software.

The drawing tools are found on the Drawing toolbar (Figure 15). This toolbar is normally located on the left side of the main Draw window. If the toolbar is not visible, go to **View > Toolbars** on the Menu bar and select **Drawing** from the available options.

As with all the components of LibreOffice, the Drawing toolbar can be unlocked and placed the Draw workspace as a floating toolbar. Toolbars can be configured by adding, moving, hiding, or deleting tools. See Chapter 1, Introducing Draw for more information.

When a shape is drawn, an object selected for editing, or text added to the drawing, the information field in the Status Bar (Figure 16) changes to reflect the action taken or in progress. See Chapter 1, Introducing Draw for more information on the Status Bar.



Figure 15: Drawing toolbar

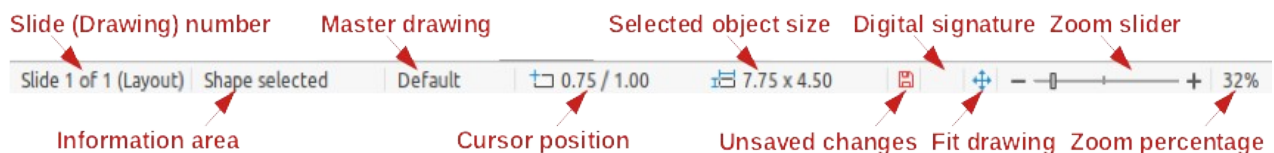

Figure 16: Status Bar

Drawing basic shapes

Basic shapes, including text, are treated as objects in Draw. The default set of tools available for drawing basic shapes on the Drawing toolbar are shown in Figure 15. To add more tools to the Drawing toolbar, see Appendix B, Toolbars and the *Getting Started Guide* for more information.

Some tool icons on the Drawing toolbar change shape according to the last tool used from the selection of available tools. Each tool that has a triangle ▼ next to the tool icon indicates that more tools are available. See “Drawing geometric shapes” on page 37 for information on the available shapes.

Note

When a basic shape is drawn, or one selected for editing, the information area at the left side in the status bar changes to reflect the present action. For example *Line created*, *Text frame xxyy selected*, and so on.

Straight lines

Creating straight lines

A straight line is the simplest element or object in Draw to create.

- 1) Use one of the following options to draw a straight line:
 - Click **Insert Line** on the Drawing toolbar.

- Click on the triangle ▼ next to **Lines and Arrows** on the Drawing toolbar and select **Insert Line** from the options available.
 - Click **Insert Line** in the **Line and Arrows** panel of the Shapes deck on the Sidebar (Figure 17).
- 2) Place the cursor at the starting point on the drawing, then click and drag the cursor to draw a straight line.
 - 3) Release the mouse button when the end point is reached and a straight line is created. A selection handle appears at each end of the line, showing that this object is the currently selected object. The selection handle at the starting point of the line is slightly larger than the selection handle at the end point, as shown in Figure 18.

 **Note**

To snap the end of a straight line to the nearest grid point, keep the *Ctrl* key pressed while drawing the straight line. This is the default behaviour of the *Ctrl* key. However, if the **Snap to Grid** option on **View > Snap Guides** on the Menu bar has been selected, pressing the *Ctrl* key while drawing a straight line temporarily deactivates the **Snap to Grid** option.

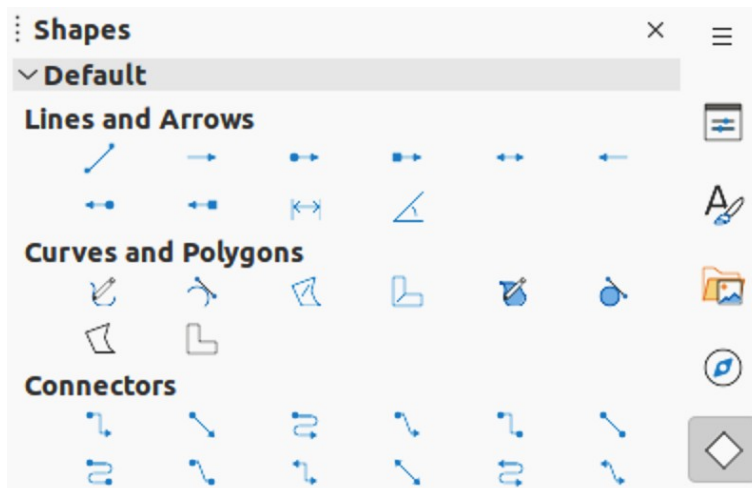

Figure 17: Lines and Arrows panel in Shapes deck on Sidebar

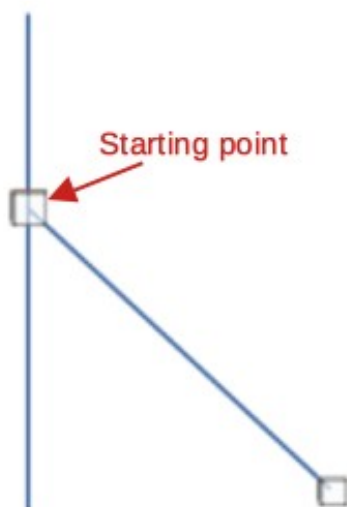

Figure 18: Line starting point

✓ Note

To restrict the drawing angle of a straight line to a multiple of 45 degrees (0, 45, 90, 135, and so on), keep the *Shift* key pressed while drawing a straight line. However, if the option **When creating or moving objects** in the *Constrain Objects* section of **Tools > Options > LibreOffice Draw > Grid** has been selected, pressing the *Shift* key temporarily deactivates this restriction.

✓ Note

To draw a straight line symmetrically outwards in both directions from the start point, keep the *Alt* key pressed while drawing the straight line. This draws straight lines from the middle of the straight line.

Formatting straight lines

When a straight line is drawn, it uses default attributes. To change any of these attributes and format a straight line to the drawing requirements:

- 1) Select the straight line by clicking on it and display the selection handles.
- 2) Use one of the following methods to access and use the formatting options for a straight line:
 - Open the **Line** panel in the Properties deck on the Sidebar (Figure 19).
 - Use the tools **Line Style**, **Line Width**, and **Line Color** on the Line and Filling toolbar (Figure 20).
 - Go to **Format > Line** on the Menu bar to open the Line dialog (Figure 21).
 - Right-click and select **Line** from the context menu to open the Line dialog.

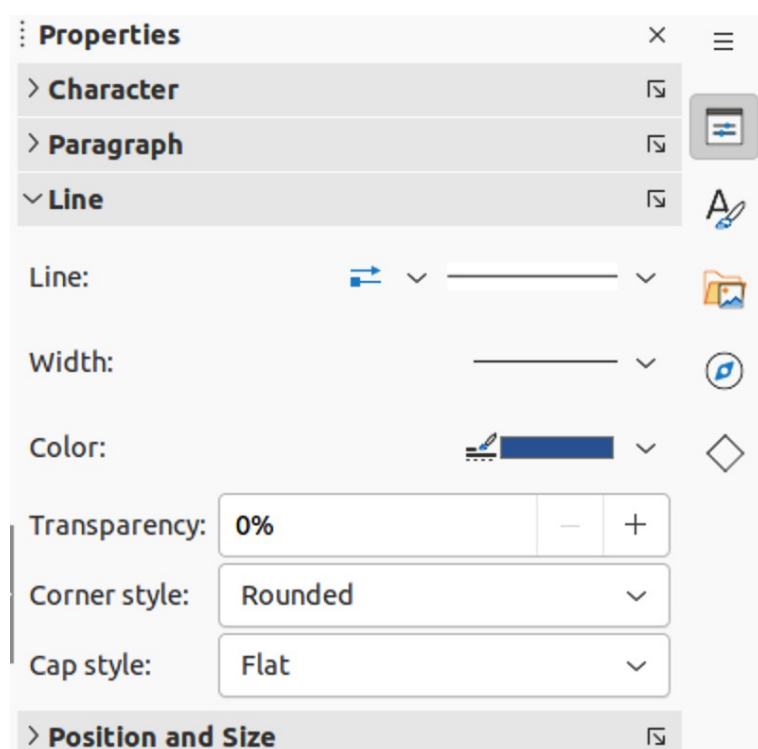

Figure 19: Line panel in Properties deck on Sidebar

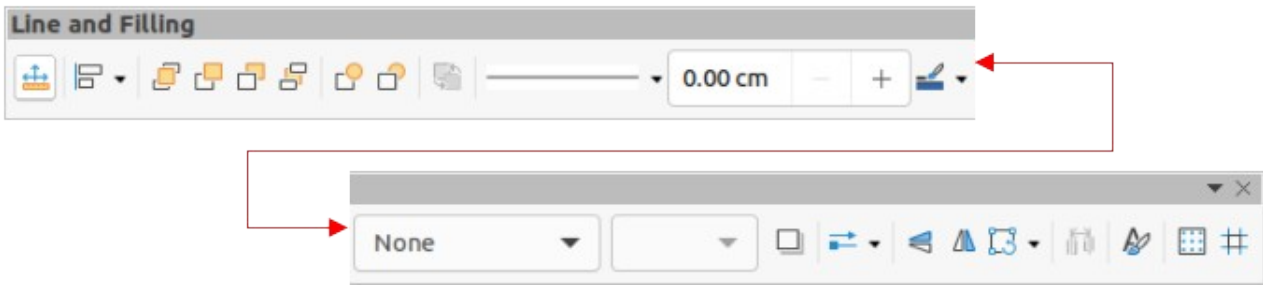

Figure 20: Line and Filling toolbar

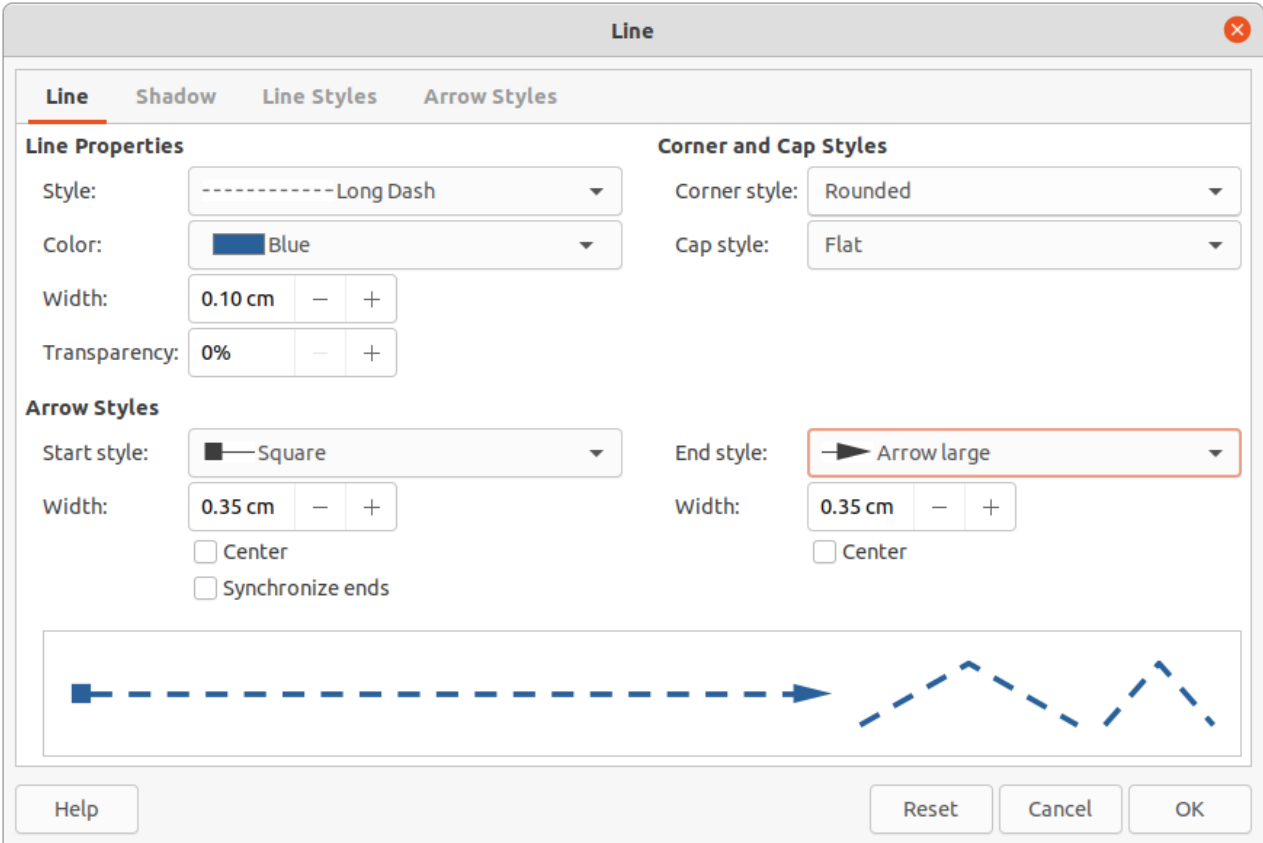

Figure 21: Line dialog - Line page

Lines and arrows

Draw classifies both lines and arrows as lines and are drawn like straight lines (for more information, see “Straight lines” on page 25). Hovering the cursor over each tool in the Lines and Arrows sub-toolbar, or the **Line and Arrows** panel in the Shapes deck on the Sidebar indicates what type of line or arrow each tool draws. The information field on the Status Bar shows them only as lines.

Creating lines or arrows

The tools available on the Lines and Arrows sub-toolbar (Figure 22) for creating lines or arrows are, from left to right:

- 1) Insert Line
- 2) Line Ends with Arrow
- 3) Line with Circle/Arrow
- 4) Line with Square/Arrow
- 5) Line with Arrows
- 6) Line Starts with Arrow
- 7) Line with Arrow/Circle
- 8) Line with Arrow/Square
- 9) Dimension Line
- 10) Line (45°)

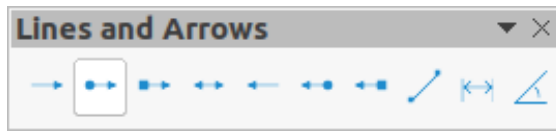

Figure 22: Lines and Arrows sub-toolbar

✓ Note

The tool icon for the last tool used is already selected on the Drawing toolbar. This makes it easier to use the same tool again.

- 1) Use one of the following methods to draw a line or arrow:
 - Click on the triangle ▼ next to **Lines and Arrows** on the Drawing toolbar and select the type of line or arrow required from the Lines and Arrows sub-toolbar (Figure 22).
 - Select the type of line or arrow required in the **Lines and Arrows** panel of the Shapes deck on the Sidebar (Figure 17 on page 26).
- 2) Place the cursor at the starting point for the line or arrow, then click and drag the cursor. The arrowhead(s) is drawn when the mouse button is released.
- 3) For more information on how to draw lines and arrows, see “Straight lines” on page 25.

Formatting line or arrow

After drawing a line or arrow, make sure it is selected and format the line or arrow to the drawing requirements using one of the following methods:

- 1) To format the line used for an arrow, see “Straight lines” on page 25 for more information.
- 2) To format an arrow using the same arrowhead style for both ends of the arrow:
 - a) Select the arrow so that the selection handles are displayed.
 - b) Go to **Format > Line** on the Menu bar or right-click on the arrow to open the Line dialog.
 - c) Click on **Arrow Styles** to open the **Arrow Styles** page (Figure 23).
 - d) Select an arrow style from the options available in the *Arrow style* drop-down list.
 - e) Click **OK** to apply the arrow style and close the Line dialog.
 - f) Click in an empty space on the drawing to deselect the arrow.
- 3) To format an arrow using different arrowhead styles for each end of the arrow:
 - a) Select the arrow so that the selection handles are displayed.
 - b) Open the **Line** panel on the Properties deck of the Sidebar (Figure 24).
 - c) In *Line*, click on **Arrow Style** to open the drop-down list for arrowhead styles
 - d) Select an arrowhead style from the left-hand list of arrowhead styles for the start point of the arrow, when the arrow was drawn.
 - e) Select an arrowhead style from the right-hand list of arrowhead styles for the end point of the arrow, when the arrow was drawn.
 - f) Click in an empty space on the drawing to deselect the arrow.

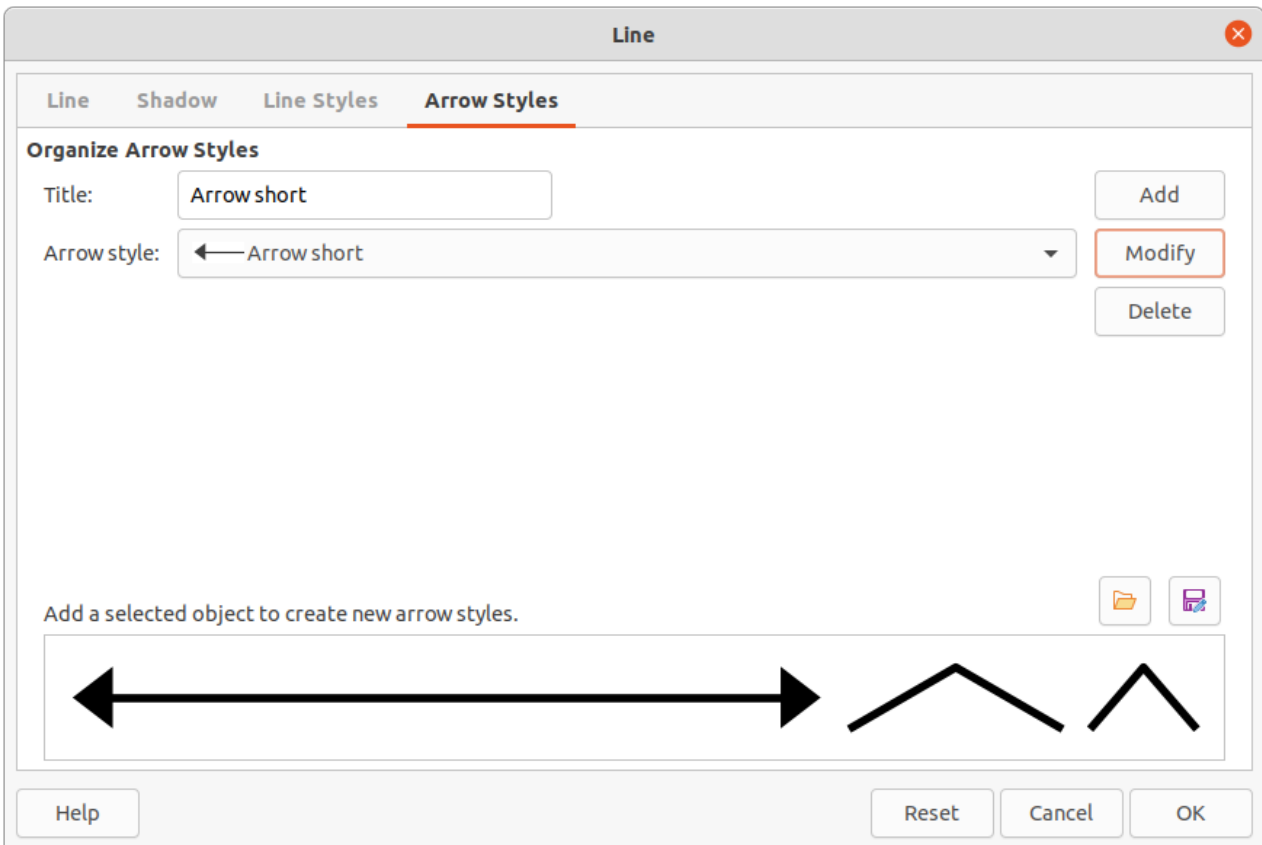

Figure 23: Line dialog - Arrow Styles page

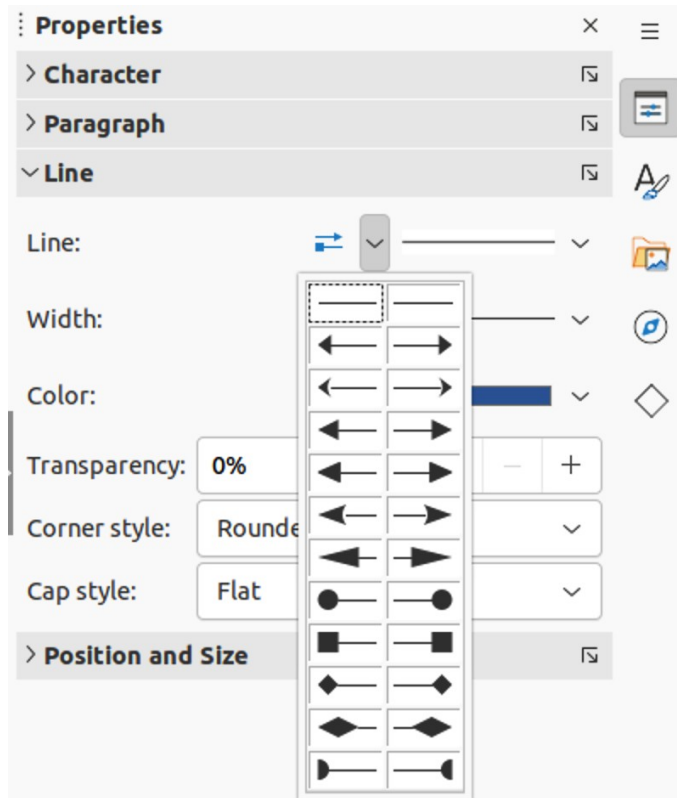

Figure 24: Arrowhead styles in Line panel in Properties deck on Sidebar

Rectangles or squares

- 1) Use one of the following methods to start drawing a rectangle or square:
 - Click on **Rectangle** in the Drawing toolbar.
 - Select the type of rectangle or square in the **Basic Shapes** panel on the Shapes deck in the Sidebar (Figure 25).
 - Click on the triangle ▼ next to **Basic Shapes** on the Drawing toolbar and select the type of rectangle or square required from the drop-down list.
 - Select the type of rectangle or square from the Legacy Rectangles toolbar (Figure 26). To display the Legacy Rectangles toolbar, go to **View > Toolbars** on the Menu bar and select it.
- 2) Place the cursor at the starting point for the rectangle or square, then click and drag the cursor until the required size is drawn. The rectangle or square is drawn from the starting point using the bottom right corner as the anchor point.
- 3) If a rectangle option is selected, hold down the *Shift* key while dragging the cursor to draw a square.
- 4) If a rectangle option is selected, hold down the *Alt* key while dragging the cursor to draw a rectangle from its center.
- 5) If a rectangle option is selected, hold down the *Shift* and *Alt* keys while dragging the cursor to draw a square from its center.
- 6) If a square option is selected, hold down the *Alt* key while dragging the cursor to draw a square from its center.

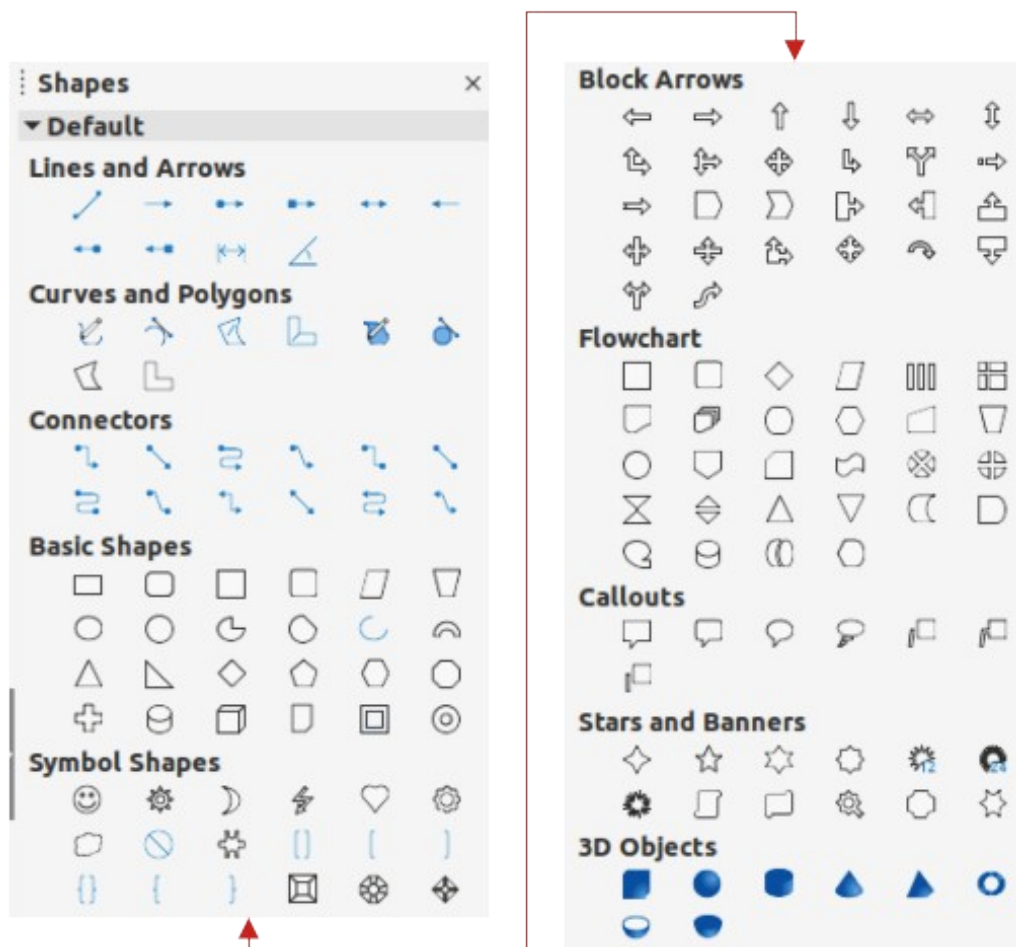

Figure 25: Shapes deck on Sidebar

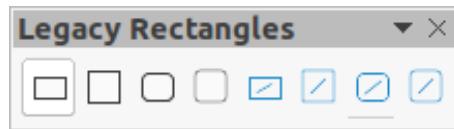

Figure 26: Legacy Rectangles toolbar

✓ Note

If the option *When creating or moving objects* has been selected in the **Constrain Object** section of **Tools > Options > LibreOffice Draw > Grid**, the action of the *Shift* key reversed. A square is drawn instead of a rectangle. To draw a rectangle, hold down the *Shift* key. This reversal of the *Shift* key action also applies when drawing ellipses, circles, arcs, and segments.

Ellipses or circles

- 1) Use one of the following methods to start drawing an ellipse or circle:
 - Click on **Ellipse** in the Drawing toolbar.
 - Select the type of ellipse or circle in the **Basic Shapes** panel on the Shapes deck in the Sidebar.
 - Click on the triangle ▼ next to **Basic Shapes** on the Drawing toolbar and select the type of ellipse or circle required from the drop-down list.
 - Select the type of ellipse or circle from the Legacy Circles and Ovals toolbar (Figure 27). To display the Legacy Circles and Ovals toolbar, go to **View > Toolbars** on the Menu bar and select it.
- 2) Place the cursor at the starting point for the ellipse or circle, then click and drag the cursor until the required size is drawn.
- 3) Place the cursor at the starting point for the ellipse or circle, then click and drag the cursor until the required size is drawn. The ellipse or circle is drawn from the starting point using the bottom right corner as the anchor point.
- 4) If an ellipse option is selected, hold down the *Shift* key while dragging the cursor to draw a circle.
- 5) If an ellipse option is selected, hold down the *Alt* key while dragging the cursor to draw an ellipse from its center.
- 6) If an ellipse option is selected, hold down the *Shift* and *Alt* keys while dragging the cursor to draw a circle from its center.
- 7) If a circle option is selected, hold down the *Alt* key while dragging the cursor to draw a circle from its center.



Figure 27: Legacy Circles and Ovals toolbar

i Tip

To quickly insert a line, rectangle, ellipse, or text, press and hold down the *Ctrl* key and then click on **Line**, **Rectangle**, **Ellipse**, or **Text** and a standard sized object is drawn automatically in the Workspace. The size, shape, and color are all standard values. These attributes can be changed later, if desired. See Chapter 4, Changing Object Attributes for more information.

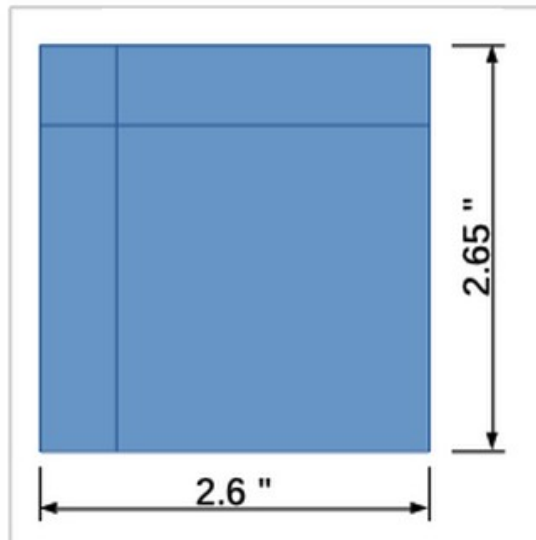

Figure 28: Dimension lines on an object

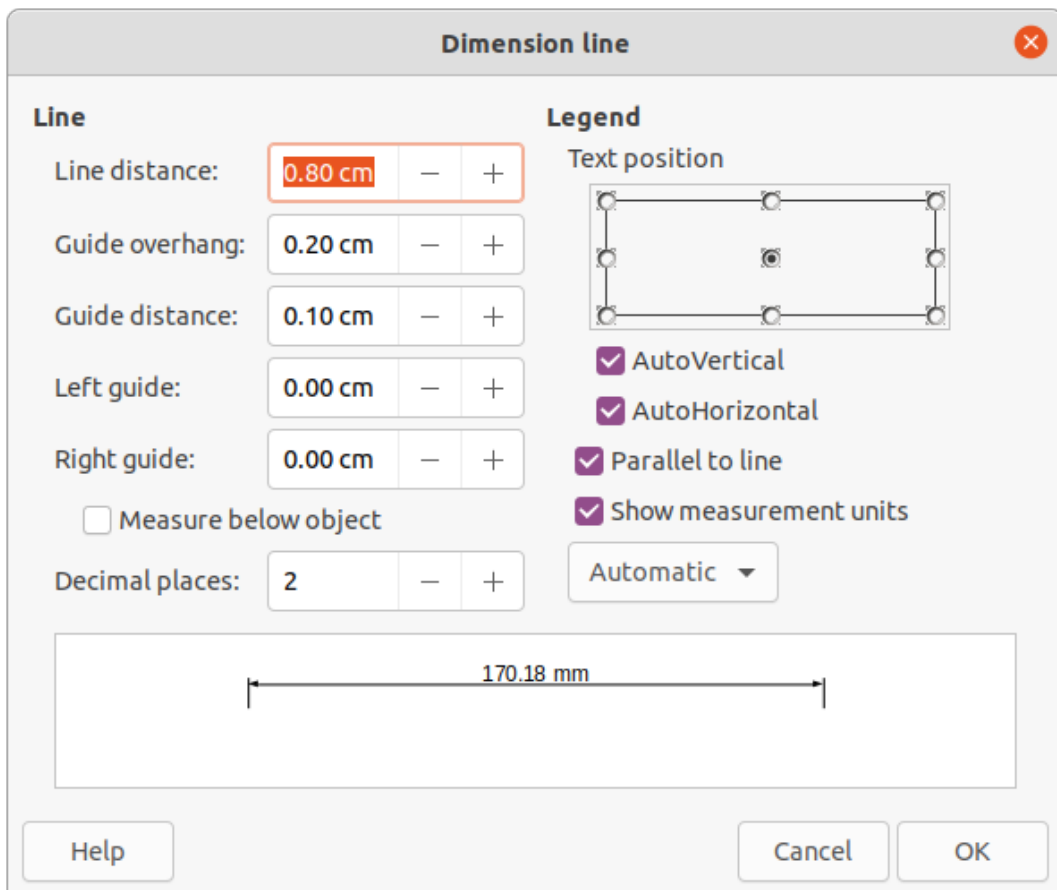

Figure 29: Dimension Line dialog

Dimension lines

Dimension lines display a measurement of an object in the drawing (Figure 28). The dimension line does not belong to the object itself, but is positioned close to it. An object can have as many dimension lines as necessary to indicate the size of its sides, edges, and distances.

To format the display of a dimension line components by right-clicking on the dimension line and selecting **Dimensions** from the context menu to open the Dimension line dialog (Figure 29).

Inserting dimension lines

- 1) Use one of the following options to start drawing a dimension line:
 - Click on the triangle ▼ next to **Lines and Arrows** on the Drawing toolbar and select **Dimension Line** from the drop-down list.
 - Click on **Dimension Line** in the **Lines and Arrows** panel of the Shapes deck on the Sidebar.
- 2) Place the cursor at the point close to the object to position the start of the dimension line.
- 3) Click and drag to draw the dimension line. As the dimension line is drawn, the dimension is displayed and automatically calculated.
- 4) Select the dimension line, then right-click on the dimension and select **Dimensions** from the context menu to open the Dimension Line dialog.
- 5) Format the dimension line using the options available the. For more information dimension line options, see Chapter 11, Advanced Draw Techniques.
- 6) Click **OK** to save the changes and close the Dimension Line dialog.
- 7) Click in an empty space on the drawing to deselect the dimension line.

Note

The measurement units used for dimension lines can be changed by going to **Tools > Options > LibreOffice Draw > Grid** on the Menu bar and select a measurement unit from the available options in the *Units of measurement* drop-down list.

Arcs and segments

- 1) Use one of the following methods to start drawing an arc or segment (partial circles or ellipses):
 - Select the type of arc or segment in the **Basic Shapes** panel on the Shapes deck in the Sidebar.
 - Click on the triangle ▼ next to **Basic Shapes** on the Drawing toolbar and select the type of arc or segment required from the drop-down list.
 - Select the type of arc or segment from the Legacy Circles and Ovals toolbar. To display the Legacy Circles and Ovals toolbar, go to **View > Toolbars** on the Menu bar and select it.
- 2) Click at the approximate start point and drag the cursor to start creating an arc or segment. Release the mouse button when the required object size is reached.
- 3) Move the cursor to the position where the arc or segment starts and click to start drawing the arc or segment. The Status Bar indicates the angle in degrees.
- 4) Move the cursor to the end position of where the arc or segment finishes. The Status Bar shows the angle in degrees.
- 5) Click again to complete the arc or segment.

Curves, polygons or freeform lines

Select the required tool for drawing curves, polygons, or freeform lines using one of the following methods:

- Click on the triangle ▼ next to **Curves and Polygons** on the Drawing toolbar and select the type of curve, polygon or freeform line from the drop-down list.
- Select the type of curve, polygon or freeform line in the **Curve and Polygons** panel of the Shapes deck on the Sidebar.

Curves

- 1) Click to create the starting point of the curve, then drag the cursor from the starting point to draw a line.
- 2) Release the mouse button and continue to drag the cursor to bend the line into the required curve shape.
- 3) Click to set the end point of the curve and position the curve on the drawing.
- 4) Continue dragging the cursor to draw straight lines at the end of the curve. Each mouse click sets a corner point and allows drawing of another straight line from each corner point.
- 5) Double-click to end the drawing of a curve and straight lines.

✓ Note

A filled curve automatically joins the last point to the first point to close off the object and fills it with the selected fill. A curve without filling is not closed at the end of the drawing.

Polygons

- 1) Click to create the start point, then drag the cursor to draw a line between the first and second corner points.
- 2) Click again to end the drawing between the first and second corner points of the polygon.
- 3) Move the cursor to draw the next line and click to finish drawing to the next corner point. Each mouse click sets a corner point and draws another line.
- 4) Double-click to end the drawing of a polygon.

✓ Note

A filled polygon automatically joins the last corner point to the first corner point to close off the figure and fills it with the selected fill. A polygon without filling is not closed at the end of the drawing.

Polygons 45°

Like ordinary polygons, these are formed from lines, but the angles between lines are restricted to 45 or 90 degrees. If required, hold down the *Shift* key as the line is drawn so that the line is drawn at an angle other than 45 or 90 degrees.

Freeform lines

Using freeform line tools is similar to drawing with a pencil on paper.

- 1) Click and drag the cursor to the line shape required.
- 2) Release the mouse button to complete the drawing of the freeform line.
- 3) If **Freeform Line Filled** is selected, the end point is joined automatically to the start point and the object is filled with the selected fill.

✓ Note

The points in curves, polygons and freeform lines can be moved and edited. See Chapter 3, Working with Objects and Chapter 11, Advanced Draw Techniques for more information.

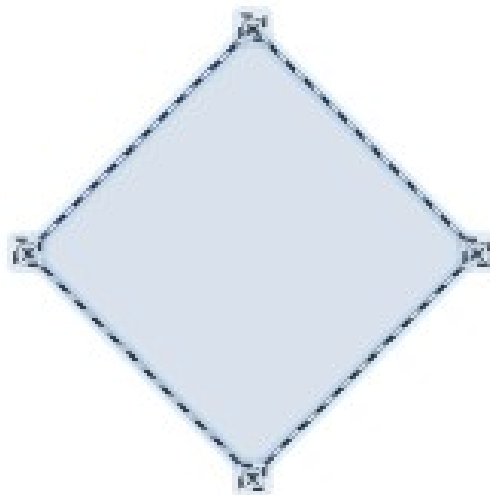

Figure 30: Example of glue points on an object

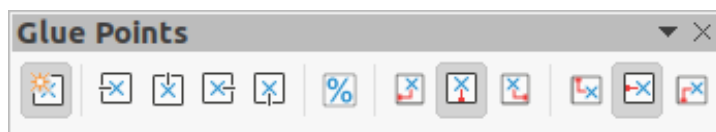

Figure 31: Glue Points toolbar

Glue points and connectors

Glue points

All Draw objects have glue points, which are not normally displayed. Glue points become visible when **Connectors** is selected on the Drawing toolbar or a connector tool is selected in the **Connectors** panel on the Shapes deck in the Sidebar.

Most objects have four glue points, as shown in the example in Figure 30. More glue points can be added and customized using the Glue Points toolbar (Figure 31). Go to **View > Toolbars > Glue Points** on the Menu bar to open the toolbar.

Glue points are not the same as the selection handles of an object. Selection handles are for moving or changing the shape of an object. Glue points are used to fix or glue a connector to an object so that when the object moves, the connector stays fixed to the object. For a more detailed description on the use of glue points, see Chapter 3, Working with Objects and Object Points and Chapter 8, Connections, Flowcharts, and Organization Charts.

Connectors

Connectors are lines or arrows whose ends automatically snap to a glue point of an object. Connectors are not the same as lines and arrows. When objects are moved or reordered, the connectors remain attached to a glue point. Figure 32 shows an example of two objects and a connector.

Draw offers a range of different connectors and connector functions. On the Drawing toolbar, click on the triangle ▼ next to Connectors and select a connector type from the drop-down list, or select a connector from the **Connectors** panel in the Shapes deck in the Sidebar. For a more detailed description of the use of connectors, see Chapter 8, Connections, Flowcharts, and Organization Charts.

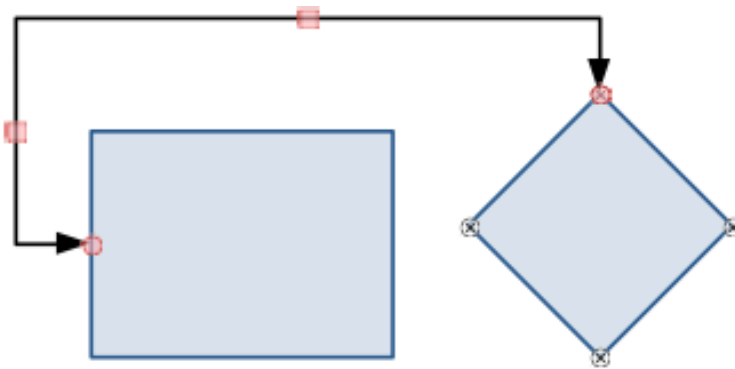

Figure 32: Example of connector between two objects

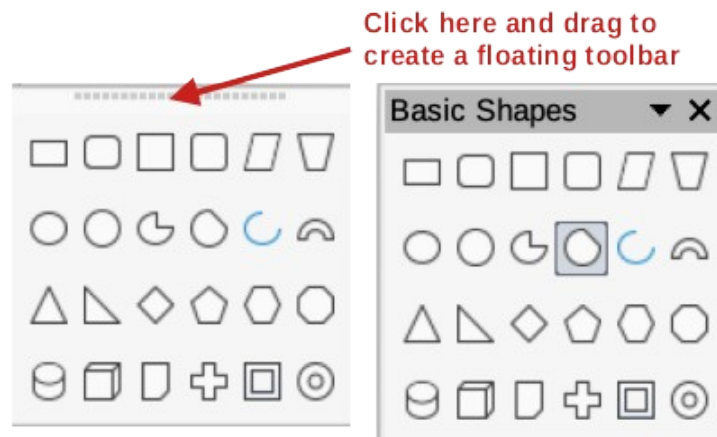

Figure 33: Creating floating toolbar

Drawing geometric shapes

The tools for drawing geometric shapes are located on the Drawing toolbar and on the Shapes deck in the Sidebar. The use of these tools for geometric shapes is similar to the tools used for drawing rectangles and squares, or ellipses and circles. For more information, see “Drawing basic shapes” on page 25.

Clicking on the triangle ▼ to the right of a tool icon on the Drawing toolbar opens a drop-down list giving access to the toolset for that shape. If necessary, this drop-down list can be “torn off” to create a floating sub-toolbar.

- Click the dotted line at the top of the toolset as shown in Figure 33, drag it across the screen to the Workspace and release the mouse button to create a floating toolbar
- To close a floating toolbar, click on the X on the right of the toolbar title.

✓ Note

The tool icons on the Drawing toolbar always indicate the last geometric shape drawn and may not be the same as the tool icons shown on the Drawing toolbar in this chapter. Indicating the last tool used makes it easier to use the same tool again.

✓ Note

Text can be added to all of these geometric shapes. For more information, see Chapter 11, Advanced Draw Techniques.

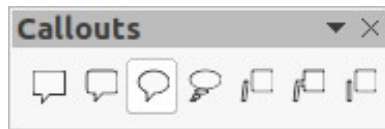

Figure 38: Callouts sub-toolbar

Stars and banners

Clicking on the triangle ▼ to the right of **Stars and Banners** on the Drawing toolbar opens the Stars and Banners sub-toolbar (Figure 39). Alternatively, select the required tool in the **Stars and Banners** panel in the Shapes deck on the Sidebar.



Figure 39: Stars and Banners sub-toolbar

3D Objects

Clicking on the triangle ▼ to the right of **3D Objects** on the Drawing toolbar opens the 3D-Objects sub-toolbar (Figure 40). Alternatively, select the required tool in the **3D-Objects** panel in the Shapes deck on the Sidebar.



Figure 40: 3D-Objects sub-toolbar

Adding, inserting and formatting text

In Draw text can be added, inserted, and formatted to a drawing, objects, and shapes. For more information on how to add, insert, and format text in a drawing or drawing objects, see Chapter 9, Adding and Formatting Text.



LibreOffice
Community



Draw Guide 7.2

Chapter 3, Working with Objects

Introduction

This chapter looks at the tools and functions to modify existing drawings. All of the functions apply to a selected object or a group of selected objects, which can be distinguished by selection handles on a rectangular frame that is large enough to contain the object. Where several objects are selected, the frame around the objects corresponds to the smallest rectangle that can contain all of the objects. This frame is called the selection rectangle.

✓ Note

The color and shape of the selection handles changes depending on the tool and function that has been selected to change the object properties. The color of the selection handles also depends on the computer operating system and how the computer has been set up.

Selecting objects

Direct selection

The easiest way to select an object is to click directly on it. For objects that are not filled, click on the object border to select it. To select more than one object, hold the *Shift* key down while clicking on objects. To deselect an object, move the cursor into a blank space on the drawing and click.

Selection by framing

Several objects can be selected at once by clicking and dragging the cursor around the objects drawing a selection rectangle around the objects. Only objects that lie entirely within this selection rectangle are selected. To select multiple objects by framing, **Select** on the Drawing toolbar must be active, as shown in Figure 41.



Figure 41: Drawing toolbar

Selecting hidden objects

If objects are located behind others and not visible, they can still be selected. When a hidden object is selected, its selection handles appear through the objects covering it.

- **Windows, Mac or Linux** – press the *Tab* key to select and cycle through the selection of objects in a drawing, stopping at the hidden object to select it. To cycle through the objects in reverse order, press *Shift+Tab*.
- **Windows or Mac only** – select the object in front of a hidden object, then press the *Alt* key and click to select the hidden object. If there are several hidden objects, keep holding down the *Alt* key and clicking until the object required is reached. To cycle through the objects in reverse order, hold down the *Alt+Shift* keys and click.

Arranging objects

In a complex drawing, several objects may be stacked on top of one another. This stacking order can be rearranged by moving an object forward or backward using one of the following methods:

- Select an object, go to **Shape > Arrange** on the Menu bar, or right-click on the object and select **Arrange** from the drop down menu, then select one of the following options:

- **Bring to Front** (*Ctrl+Shift++*)
- **Bring Forward** (*Ctrl++*)
- **Send Backward** (*Ctrl+-*)
- **Send to Back** (*Ctrl+Shift+-*)
- **In Front of Object**
- **Behind Object**
- Select an object, then select one of the **Arrange** tools at the left end of the Line and Filling toolbar (Figure 42). When the cursor is hovered over a tool, its function is indicated.

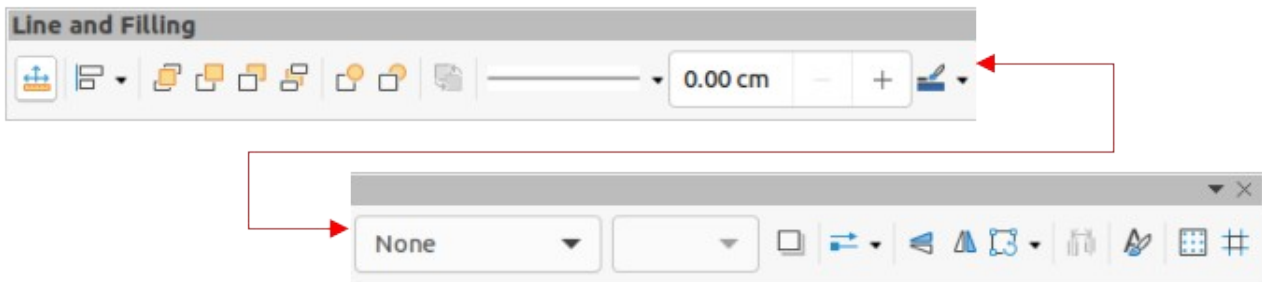

Figure 42: Line and Filling toolbar

✓ Note

The Line and Filling toolbar is not visible in the default installation of LibreOffice. To make this toolbar visible, go to **View > Toolbars > Line and Filling** on the Menu bar.

Positioning and adjusting objects

Using zoom

To help in the positioning and adjustment of objects, Draw has a zoom function that reduces or enlarges the screen display of the current drawing. For example, zoom in to position objects on a drawing with greater accuracy; zoom out to see the complete drawing. Zooming is controlled using the Status Bar, Zoom & View Layout dialog, or Zoom toolbar.

✓ Note

Zooming is handled differently in Linux and Windows operating systems. A drawing saved with a 100% zoom factor in Windows is displayed at a larger zoom factor in Linux.

Status bar

The zoom controls are located on the right side of the Status Bar (Figure 43) and these controls give quick and easy access to zooming.

- Fit slide to current window – fits the drawing to the open window.
- Minus sign (-) – reduces the zoom factor
- Plus sign (+) – increases the zoom factor.
- Click and drag the zoom slider to increase or decrease the zoom factor.
- Right-click on the zoom percentage number and select a zoom factor from the context menu that opens.

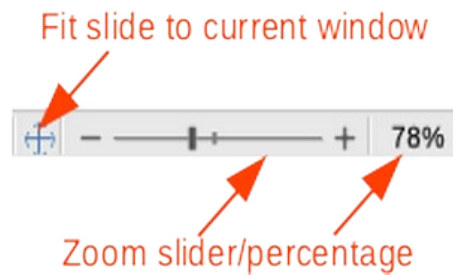

Figure 43: Zoom controls on Status Bar

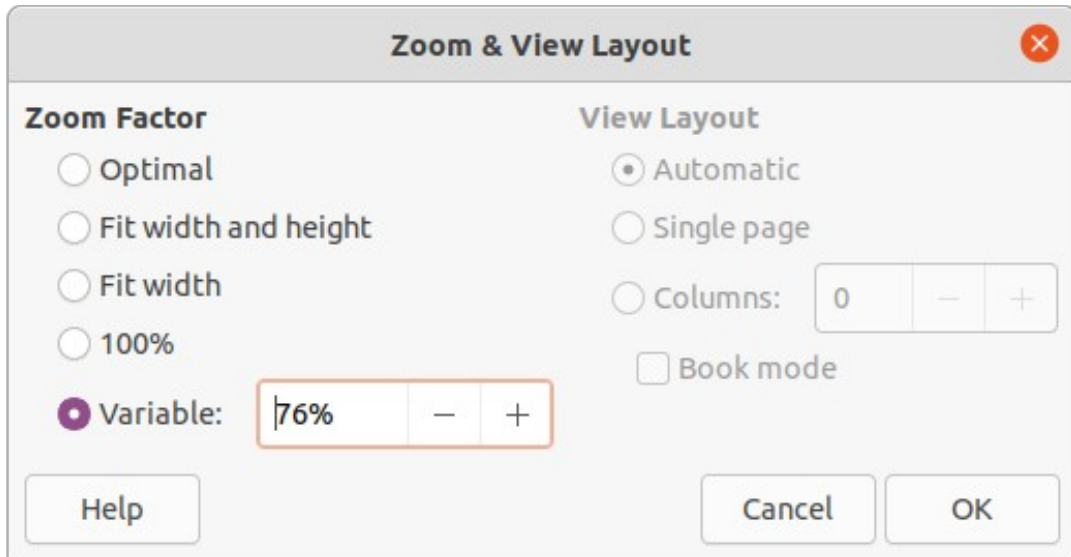

Figure 44: Zoom & View Layout dialog

- Double-click on the zoom percentage number and select a zoom factor from the Zoom & View Layout dialog (Figure 44), or go to **View > Zoom > Zoom** on the Menu bar to open the Zoom & View Layout dialog.

Zoom & View Layout dialog

The Zoom & View Layout dialog provides the following options to control how a drawing is viewed on a monitor.

- **Zoom Factor** – sets the zoom factor at which to display the current document and all documents of the same type that are subsequently opened.
 - *Optimal* – resizes the display to fit the width of the text in the document.
 - *Fit width and height* – displays the entire page on the screen.
 - *Fit width* – displays the complete width of the document page. The top and bottom edges of the page may not be visible.
 - *100%* – displays the document at its actual size.
 - *Variable* – enter a percentage in the box for the zoom factor to display the document.
- **View Layout** – used to set the view layout and is not available for drawings. View layout is normally used in text documents to see the effects of different layout settings.

Zoom toolbar

Go to **View > Toolbars > Zoom** on the Menu bar to open the Zoom toolbar (Figure 45). The tools available on this toolbar, from left to right, are as follows:

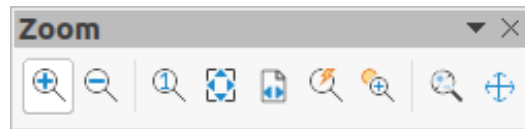

Figure 45: Zoom toolbar

- **Zoom In** – displays the drawing at two times its current size each time the tool is selected.
- **Zoom Out** – displays the drawing at half its current size each time the tool is selected.
- **100%** – displays the drawing at its actual size.
- **Zoom Previous** – returns the display of the drawing to the previous zoom factor applied.
- **Zoom Next** – undoes the action of the previous zoom command.
- **Entire Page** – displays the whole drawing in the Workspace.
- **Page Width** – displays the complete width of the drawing. The top and bottom edges of the slide may not be visible.
- **Optimal** – resizes the display to include all of the objects on the slide.
- **Object Zoom** – resizes the display to fit the selected object(s).
- **Zoom & Pan** – zooms in for each mouse click. *Ctrl+click* zooms out for each click. *Shift+click* allows panning of the drawing.
- **Shift** – moves the drawing within the Draw workspace. Place the cursor on the drawing and drag to move the drawing.

Moving and adjusting object size

When moving an object or changing its size, check the left-hand area of the Status Bar at the bottom of the Workspace (Figure 46). From left to right, this area shows that a shape is selected, its position on the drawing in X/Y coordinates and dimensions of the object. The measurement units are those selected in **Tools > Options > LibreOffice Draw > General**.

Moving objects

To move an object (or a group of objects), select it and then click and drag within the object borders. During movement, a ghost image of the object appears to help with repositioning (Figure 47). When the object reaches its new location, release the mouse button.

Adjusting object size

To change the size of a selected object (or a group of selected objects), move the mouse cursor to one of the selection handles. The cursor changes shape to indicate the direction of movement for that selection handle. As the object size changes, a ghosted outline of the object appears (Figure 48). When the desired size of the object is reached, release the mouse button.

The results depend on which selection handle is used. To resize an object along one axis, use a side, top, or bottom handle. To resize along both axes, use a corner handle.



Note

Press and hold the *Shift* key while resizing an object. The change in size is carried out symmetrically with respect to object width and height so that the aspect ratio of the object remains the same. This *Shift* key behavior works on all selection handles.

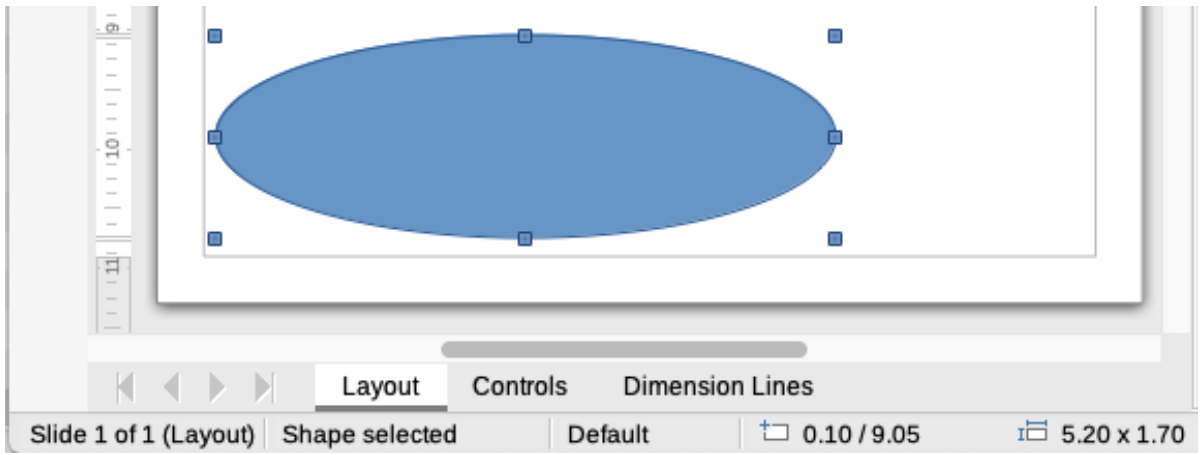

Figure 46: Left end of Status Bar when working with objects

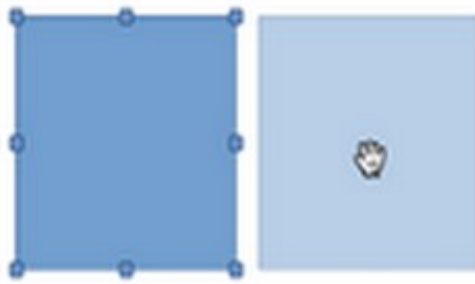

Figure 47: Moving objects



Figure 48: Adjusting object size

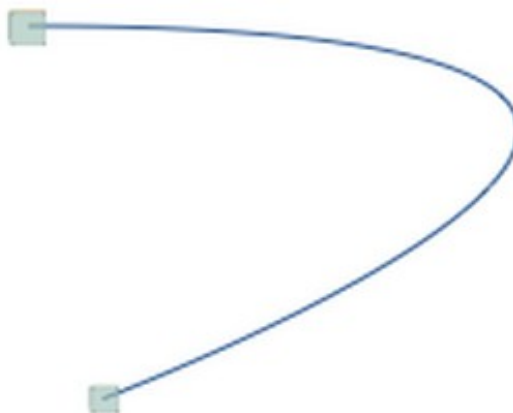

Figure 49: Modifying arcs

Modifying arcs

The size of an arc can be changed by adjusting the positions of the start and end points of an arc. Select an arc, then right click on the arc and select **Points** from the drop down menu or press the *F8* key. Two handles appear at the start and end of the arc (Figure 49). Click on one of these handles and drag it to a new position to change the shape of the arc.

Rotating and slanting objects

Rotating objects

To rotate an object (or a group of objects), select the object, then go to rotation mode using one of the following methods.

- 1) Select or click on an object
- 2) Use one of the following methods to switch to rotation mode. The selection handles change shape and color and a center of rotation indicator appears in the center of the object, as shown in Figure 50.
 - Click again on a selected object.
 - Click on the triangle ▼ on the right of **Transformations** on the Line and Filling toolbar and select **Rotate** from the pop up menu.
 - Go to **View > Toolbars > Transformations** on the Menu bar to open the Transformations toolbar (Figure 51) and select **Rotate**.
- 3) Move the cursor over the handles and the cursor changes shape. The corner handles are for rotating the object, and the top, bottom and side handles are to shear or slant the object.

✓ Note

The rotation center is normally located at the center of an object. To change the position of the rotation center, click on the rotation center and drag until it is at the desired position. This rotation center can even be outside of the object.

✓ Note

Rotation works in a slightly different way for 3D objects because it occurs in a three dimensional space and not in a single plane. See Chapter 7, Working with 3D Objects for more information.

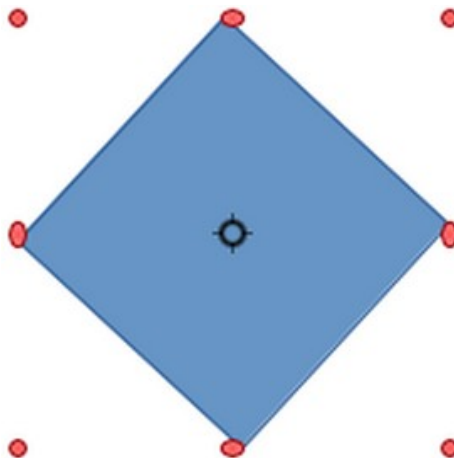

Figure 50: Rotating objects

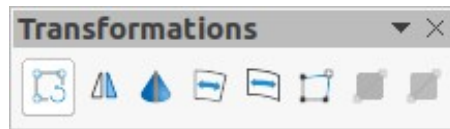

Figure 51: Transformations toolbar

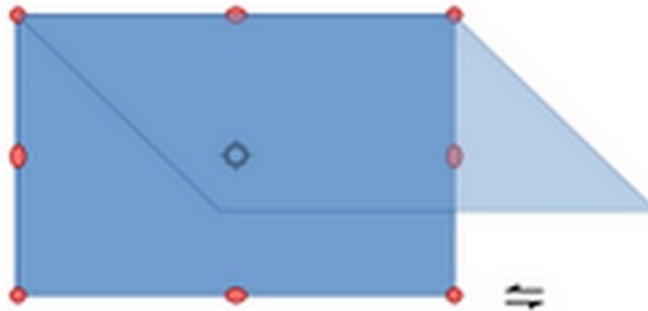

Figure 52: Slanting objects

Slanting objects

To slant an object, select the object and switch on rotation mode (see “Rotating objects” above). Click on the handles located at the midpoints on the top, bottom and sides of a selected object. The cursor changes shape when it hovers over one of these midpoint handles indicating the direction of slanting.

The axis used for slanting an object is the object edge directly opposite the midpoint handle being used to slant the object. This axis stays fixed in location while the other sides of the object move in relation to it as the selection is dragged (Figure 52). Click and drag the cursor to slant the object. A ghosted outline of the object being slanted appears and the current angle of slanting is shown in the status bar.

✓ Note

Press and hold the *Shift* key while rotating or slanting an object, movement is restricted to 15°. This is the default behavior of the *Shift* key. However, if **When creating or moving objects** has been selected in **Tools > Options > LibreOffice Draw > Grid**, the action of the *Shift* key is reversed and rotation or slanting is restricted to 15° of movement unless the *Shift* key is pressed.

Setting exact position, size, rotation and slant

Using the mouse to position and resize objects is not exact. If greater accuracy is required to position and size an object, it is recommended to use the Position and Size dialog (Figure 53) or the **Position and Size** panel (Figure 54) in the Properties deck on the Sidebar.

- To open the Position and Size dialog, select the object and use one of the following methods:
 - Go to **Format > Position and Size** on the Menu bar.
 - Right-click on the object and select **Position and Size** from the context menu.
 - Use the keyboard shortcut *F4*.
- To open the **Position and Size** panel in the Properties deck on the Sidebar, select the object, then click on **Properties** on the Sidebar and click on the down arrow next to the **Position and Size** title bar to open the panel.

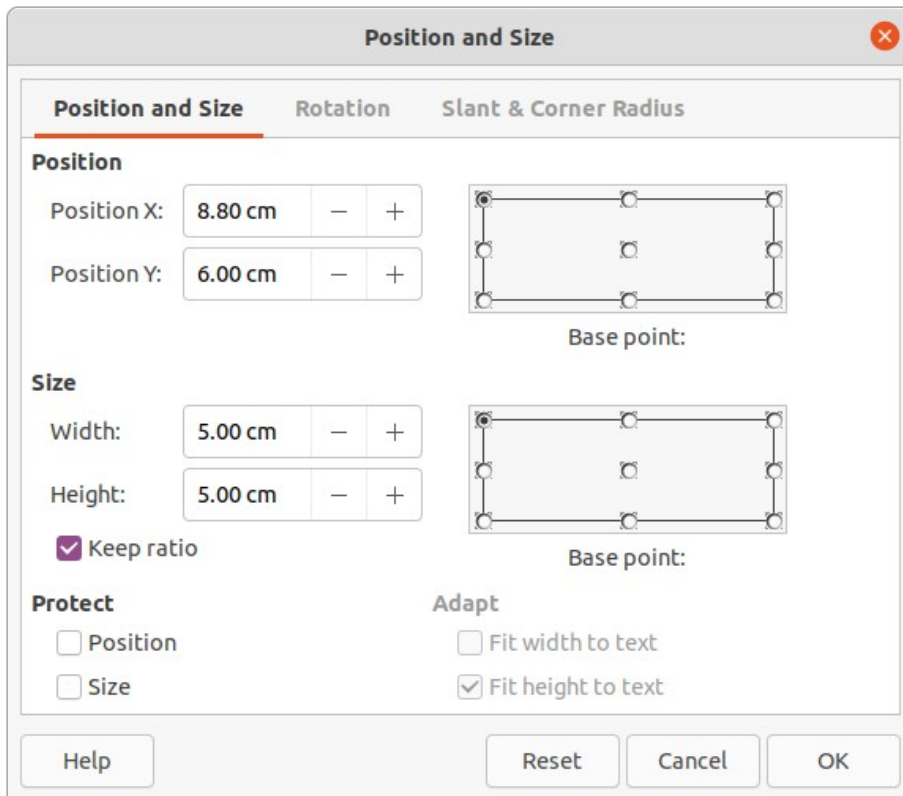

Figure 53: Position and Size dialog

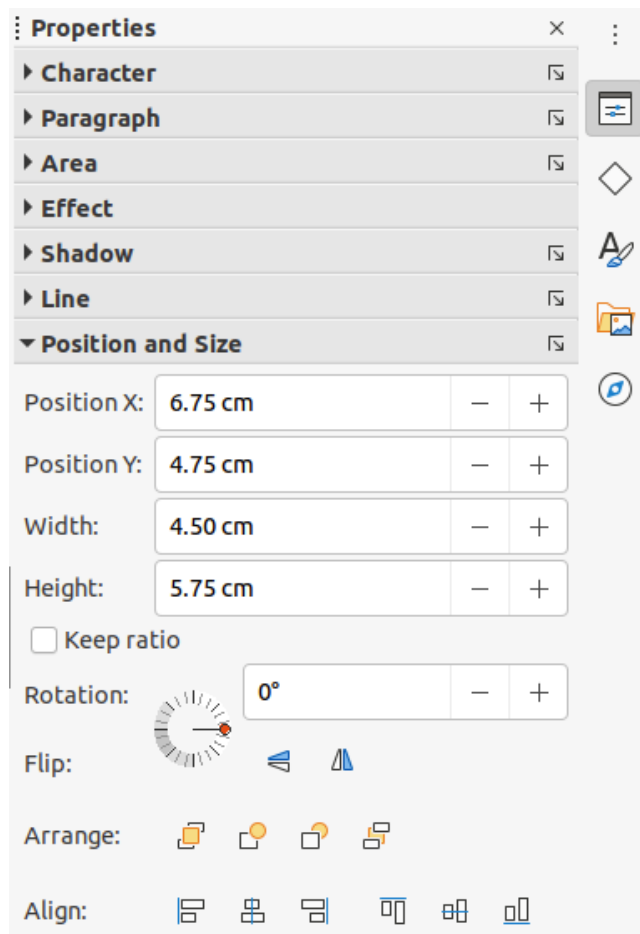

Figure 54: Position and Size panel in Properties deck on Sidebar

The options available in the Position and Size dialog and the **Position and Size** panel in the Properties deck on the Sidebar are similar. On the Sidebar, however, the following options are not available:

- Position and size of an object cannot be protected.
- Adapt an object to fit any text.
- Set the base point position for position and size.

Position and Size

- **Position** – specify the location of the selected object on the page.
 - *Position X* – enter the horizontal distance required to move the object relative to the base point selected in the grid.
 - *Position Y* – enter the vertical distance required to move the object relative to the base point selected in the grid.
 - *Base point* – select a base point in the grid and then enter the amount required to shift the object relative to the base point that is selected in the *Position Y* and *Position X* boxes. The base points correspond to the selection handles on an object. This option is only available in the Position and Size dialog.
- **Size** – specify the amount required to resize the selected object with respect to the selected base point.
 - *Width* – enter a width for the selected object.
 - *Height* – enter a height for the selected object.
 - *Keep ratio* – maintains proportions when resizing the selected object.
 - *Base point* – select a base point in the grid, and then enter the new size dimensions for the selected object in the *Width* and *Height* boxes. This option is only available in the Position and Size dialog.
- **Protect** – this option is only available in the Position and Size dialog.
 - *Position* – prevents changes to the position or the size of the selected object.
 - *Size* – prevents resizing of the object.
- **Adapt** – specifies, if the size of a text box should be adjusted to fit the size of entered text. This option is only available for text boxes.
 - *Fit width to text* – expands the width of the object to the width of the text, if the object is smaller than the text.
 - *Fit height to text* – expands the height of the object to the height of the text, if the object is smaller than the text.

The units of measurement used for X/Y coordinates and the width and height of the object are set by going to **Tools > Options > LibreOffice Draw > General**.

The default location of the base points for position and size is the upper left corner of the drawing area. This base point can be temporarily change to make positioning or dimensioning simpler by clicking on a position corresponding to the location of the base point required. This change in base point is only valid for single use and the base point is reset to the standard position of top left corner when the Position and Size dialog is closed.

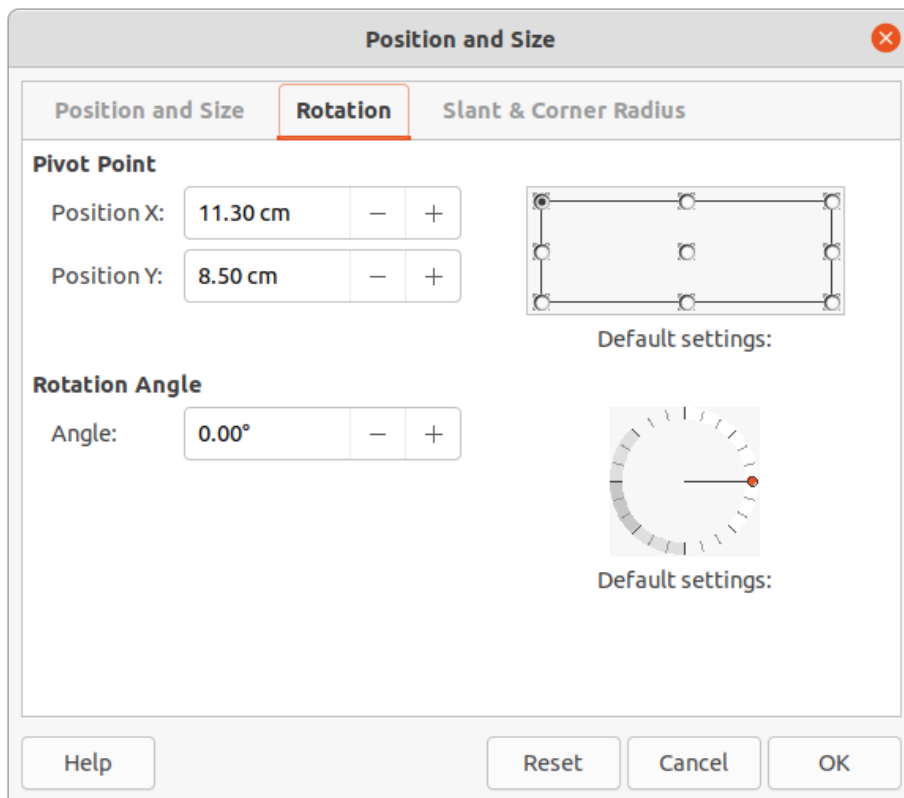

Figure 55: Position and Size dialog - Rotation page

Rotating objects

To accurately rotate an object, click on the **Rotation** tab of the Position and Size dialog (Figure 55). The options available allow the rotation angle and the location of the pivot point to be defined. Alternatively, use the available options for rotation in the *Position and Size* panel in the Properties deck on the Sidebar.

- **Pivot Point** – the selected object is rotated around a specified pivot point. The default pivot point is at the center of the object. If a pivot point is set too far outside of the object boundaries, the object could be rotated off of the page. This option is only available in the Position and Size dialog.
 - *Position X* – enter horizontal distance from the left edge of the page to the pivot point.
 - *Position Y* – enter vertical distance from the top edge of the page to the pivot point.
 - *Default settings* – select the position of the pivot point. Default position is the center of the object. Changing the rotation pivot point is only valid for single use. The pivot point is reset to default settings when the Position and Size dialog is closed.
- **Rotation** – specify the number of degrees that required to rotate the selected object, or click in the rotation grid.
 - *Angle* – enter the number of degrees that required to rotate the selected object. This option is only available in the Position and Size dialog.
 - *Default settings* – click on the indicator to rotate the object. The number of degrees is shown in the Angle box as the indicator is rotated. This option is only available in the Position and Size dialog.
 - *Rotation* – click on the indicator to rotate the selected object, or set the angle in the text box, or select a predetermined angle from the drop down list. This option is only available in the **Position and Size** panel in the Properties deck on the Sidebar.

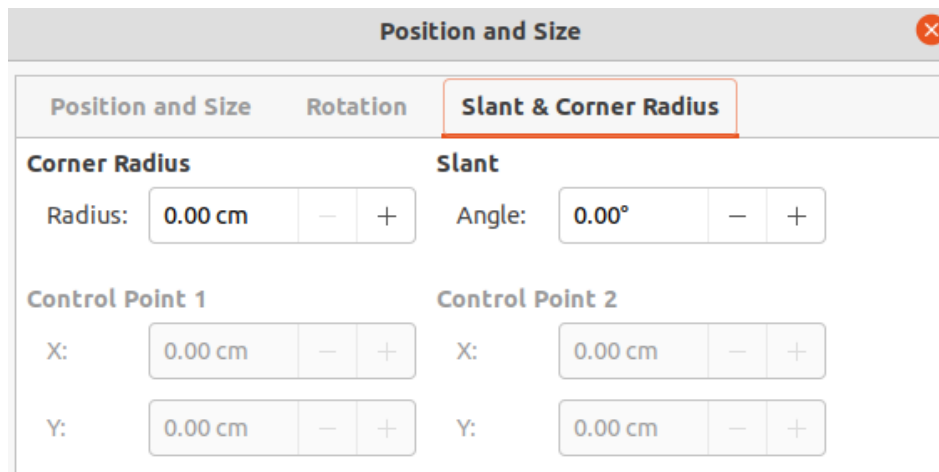

Figure 56: Position and Size dialog - Slant & Corner Radius page

Slant and corner radius

To accurately set the corner radius or slant angle of an object, click on the **Slant & Corner Radius** tab of the Position and Size dialog (Figure 56). Options for slant and corner radius are only available in the Position and Size dialog.

✓ Note

To set the **Corner Radius**, rectangles and squares available on the Legacy Rectangles have to be used. This toolbar is optional and is opened by going to **View > Toolbars > Legacy Rectangles** on the Menu bar.

- **Corner Radius** – this option is only available for the corners of a rectangular or square object that has been created using the Legacy Rectangles toolbar. If this option is grayed out, the corner radius cannot be set.
 - *Radius* – enter the radius of the circle that to be used to round the corners. The larger the value for corner radius set, the rounder corners of a rectangle or square become.
- **Slant** – slants the selected object along the bottom edge of the object.
 - *Angle* – enter the angle of the slant axis. The slant angle relates to how much an object inclines or slants from its normal vertical position on a drawing.
- **Control Point 1 and 2** – enter a value to set the X and Y coordinates of the top left corner of the object. If these options are grayed out, then coordinates cannot be set.

Using grid and snap functions

In Draw, objects can be positioned accurately and consistently using grid points, snap points and lines, object frames, individual points on objects, or page edges. This function is known as snap and it is easier to use snap functions at the highest practical zoom value for a drawing. Two different snap functions can be used at the same time. For example, snapping to a guide line and the page edge. However, it is recommended to activate only those snap functions that are really required.

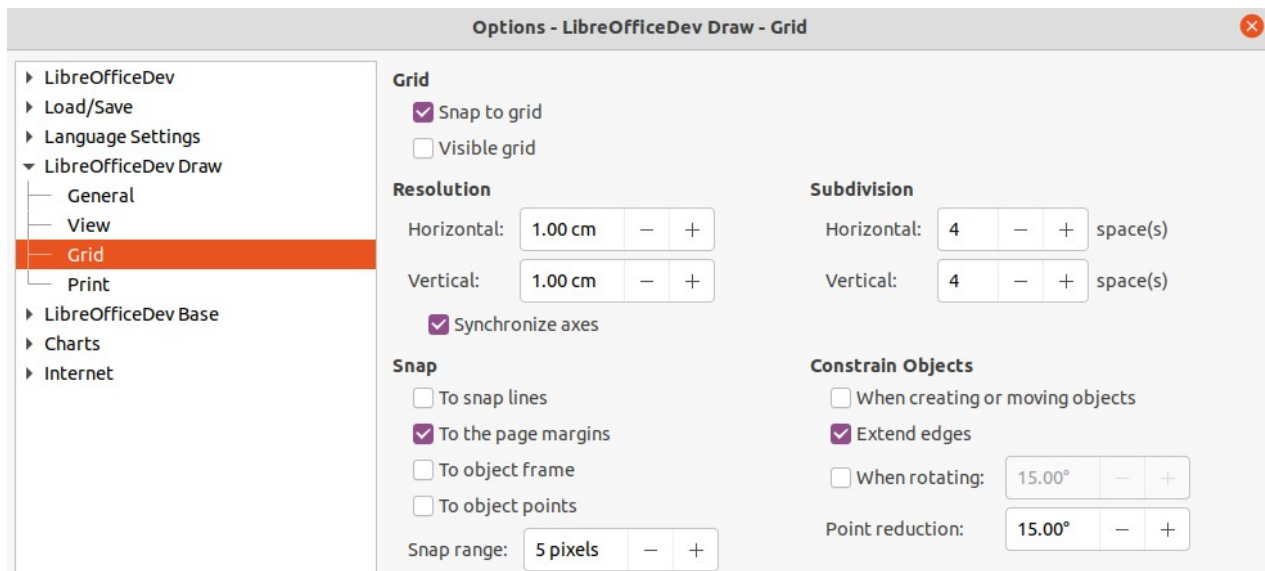

Figure 57: Options LibreOffice Draw Grid dialog



Figure 58: Options toolbar

Configuring grid and snap functions

To configure the grid and snap functions in a drawing, go to **Tools > Options > LibreOffice Draw > Grid** on the Menu bar to display the Grid dialog (Figure 57). The grid and snap functions can also be displayed and switched on or off using this dialog, right-clicking on a drawing and using the options in the context menu, or using the icons in the Options toolbar (Figure 58). If the Options toolbar is not open, go to **View > Toolbars > Options** on the Menu bar.

- **Grid** – specifies the settings for the configurable grid on document pages. This grid helps to determine the exact position of objects. Also, this grid can be set in line with the magnetic snap grid. If the snap grid is activated, but want to move or create individual objects without snap positions, keep the *Shift* key pressed to deactivate this function.
 - *Snap to grid* – specifies whether to move frames, drawing elements, and controls only between grid points. To change the status of the snap grip only for the current action, drag an object while holding down the *Ctrl* key.
 - *Visible grid* – specifies whether to display the grid.
- **Resolution**
 - *Horizontal* – defines the unit of measure for the spacing between grid points on the X-axis.
 - *Vertical* – defines the grid points spacing in the desired unit of measurement on the Y-axis.
- **Subdivision**
 - *Horizontal* – specify the number of intermediate spaces between grid points on the X-axis.
 - *Vertical* – specify the number of intermediate spaces between grid points on the Y-axis.
- **Synchronize axes** – specifies whether to change the current grid settings symmetrically. The resolution and subdivision for the X and Y axes remain the same.

- **Snap**
 - *To snap lines* – snaps the edge of a dragged object to the nearest snap line when the mouse button is released. This setting can also be defined using **Snap to Snap Guides** on the Options toolbar.
 - *To the page margins* – specifies whether to align the contour of the graphic object to the nearest page margin. The cursor or a contour line of the graphics object must be in the snap range. This function can also be accessed using **Snap to Page Margins** in the Options toolbar.
 - *To object frame* – specifies whether to align the contour of the graphic object to the border of the nearest graphic object. The cursor or a contour line of the graphics object must be in the snap range. This function can also be accessed with **Snap to Object Border** in the Options toolbar.
 - *To object points* – specifies whether to align the contour of the graphic object to the points of the nearest graphic object. This only applies if the cursor or a contour line of the graphics object is in the snap range. This function can also be accessed with **Snap to Object Points** in the Options toolbar.
 - *Snap range* – defines the snap distance between the mouse pointer and the object contour. Snaps to a snap point if the cursor is closer than the distance selected.
- **Constrain Objects**
 - *When creating or moving objects* – specifies that graphic objects are restricted vertically, horizontally or diagonally (45°) when creating or moving them. This setting can be temporarily deactivated by pressing the *Shift* key.
 - *Extend edges* – specifies that a square is created based on the longer side of a rectangle when the *Shift* key is pressed before releasing the mouse button. This also applies to an ellipse (a circle is created based on the longest diameter of the ellipse). When *Extend edges* is not selected, a square or a circle is created based on the shorter side or diameter.
 - *When rotating* – specifies that graphic objects can only be rotated within the rotation angle that is selected. To rotate an object outside the defined angle, press the *Shift* key when rotating. Release the key when the desired rotation angle is reached.
 - *Point reduction* – defines the angle for point reduction. When working with polygons, this may be useful in reducing the editing points.

Snap to grid

Using Snap to Grid

Using **Snap to Grid** moves an object exactly onto a grid point in a drawing. This function can be switched on and off using one of the following methods:

- Go to **View > Snap Guides > Snap to Grid** on the Menu bar.
- Right-click on a drawing and select **Snap Guides > Snap to Grid** from the context menu.
- Click on **Snap to Grid** on the Options toolbar.

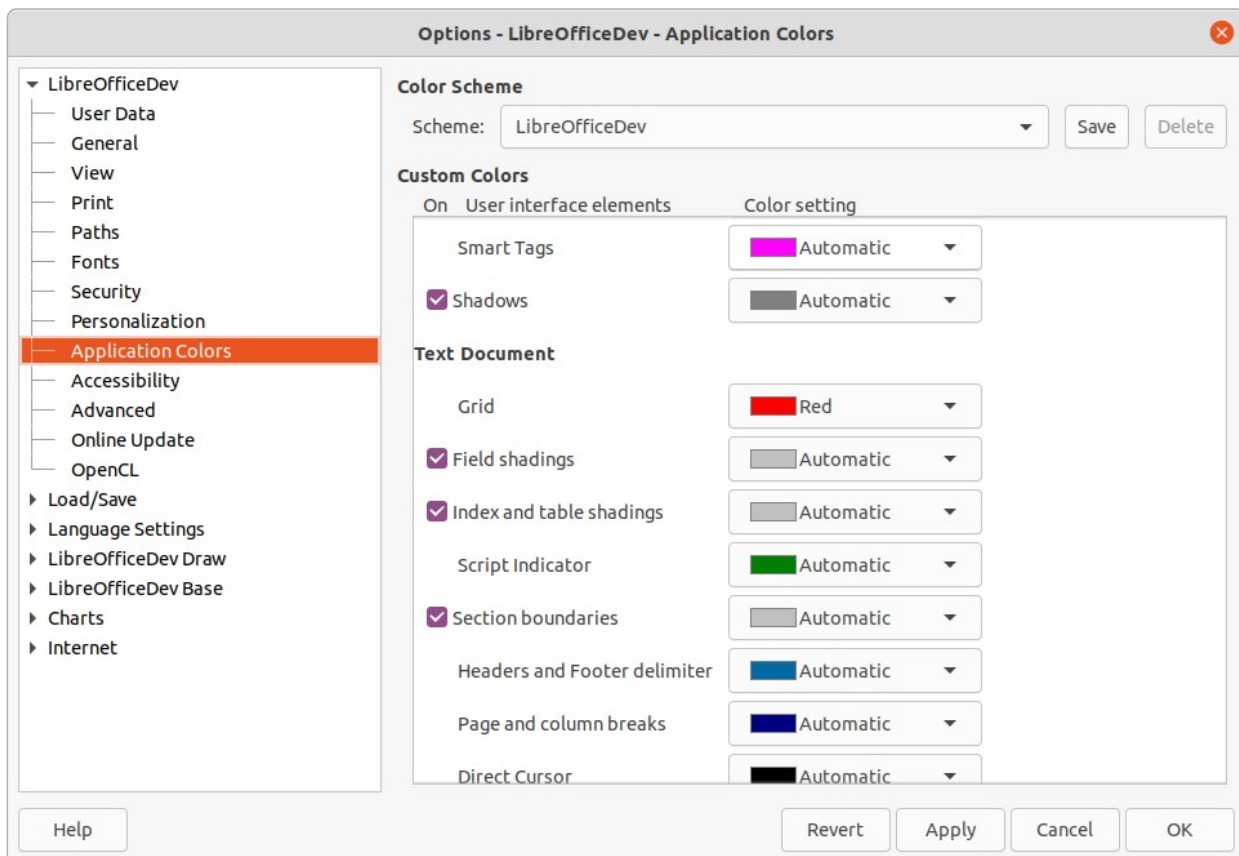

Figure 59: Options LibreOffice Application Colors dialog

Displaying grid

Displaying or turning off the grid in a drawing is done using one of the following methods:

- Go to **View > Grid and Helplines > Display Grid** on the Menu bar.
- Click on **Display Grid** on the Options toolbar.
- Right-click on a drawing and select **Grid and Helplines > Display Grid** from the context menu.
- Select **Visible grid** in the Options LibreOffice Draw Grid dialog.

Changing color of grid points

By default and depending on the display and computer setup, the grid points are gray and are not always easy to see. To change the color of the grid points, go to **Tools > Options > LibreOffice > Application Colors** to open the Application Colors dialog (Figure 59). In

Drawing/Presentation, select a more suitable color for the grid from the drop-down list.

Snap points and lines

Unlike the grid, snap lines and snap points can be inserted when to position an object to a specific position on a drawing. Snap lines can either be horizontally or vertically and appear as dashed lines. Snap points appear as small crosses with dashed lines. Snap points and snap lines do not appear in printed output.

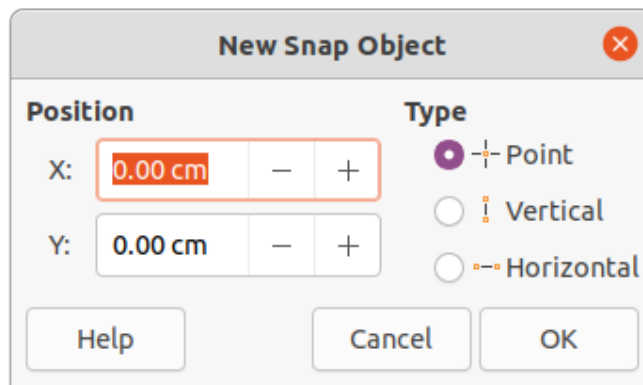

Figure 60: New Snap Object dialog

Inserting snap points and snap lines

To insert a snap point or snap line, go to **Insert > Snap Guide** on the Menu bar to open the New Snap Object dialog (Figure 60).

- **Position** – sets the position of a selected snap point or line relative to the top left corner of the page.
 - *X axis* – enter the amount of space required between the snap point or line and the left edge of the page.
 - *Y axis* – enter the amount of space required between the snap point or line and the top edge of the page.
- **Type** – specifies the type of snap object being inserted.
 - *Point* – inserts a snap point.
 - *Vertical* – inserts a vertical snap line.
 - *Horizontal* – inserts a horizontal snap line.

Displaying snap points and lines

Displaying or turning off snap points and lines in a drawing can be done using one of these methods:

- Go to **View > Snap Guides > Display Snap Guides** on the Menu bar.
- Click on **Display Snap Guides** in the Options toolbar.
- Right-click on a drawing and select **Snap Guides > Display Snap Guides** from the context menu.

Editing snap points and lines

To edit a snap point, right-click on the snap point and select **Edit Snap Point** from the context menu to open the Edit Snap Point dialog (Figure 61). Enter new X and Y coordinate settings for the snap point and click **OK**. Alternatively, drag a snap point to a new position on a drawing.

To edit a snap line, right-click on the snap line and select **Edit Snap Line** from the context menu to open the Edit Snap Line dialog (Figure 62). Enter a new X coordinate setting for vertical snap lines or a new Y coordinate setting for horizontal snap lines and click **OK**. Alternatively, drag a snap line to a new position on a drawing.

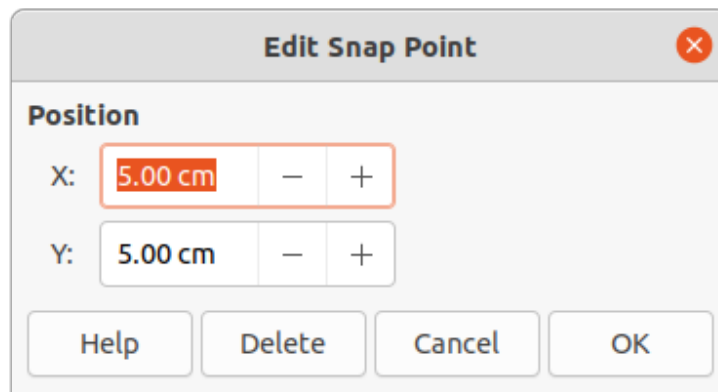

Figure 61: Edit Snap Point dialog

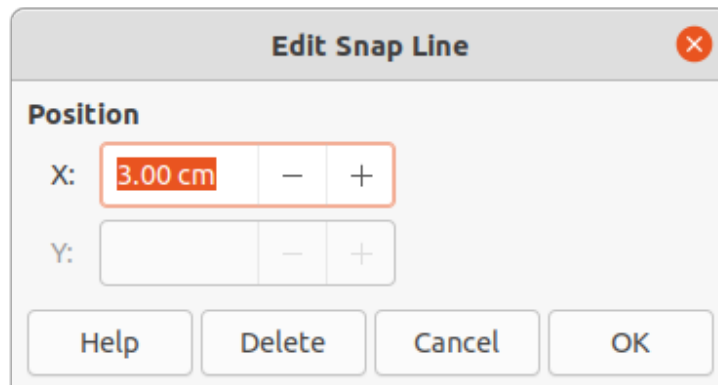

Figure 62: Edit Snap Line dialog

Deleting snap points and lines

To delete a snap point, drag it back to a ruler or right-click on the snap point and select **Delete Snap Point** from the context menu. To delete a snap line, drag it back to the ruler or right-click on the snap line and select **Delete Snap Line** from the context menu.

Configuring snap range

To configure the snap range of when an object snaps to position

- 1) Go to **Tools > Options > LibreOffice Draw > Grid** on the Menu bar to open the Options LibreOffice Grid dialog.
- 2) Enter the number of pixels to set the proximity of when the object will snap into position in the *Snap range* box. The default setting is 5 pixels.
- 3) Click **OK** to set the new snap range and close the dialog.

Using Helplines

Helplines are a function in Draw to help in positioning of objects. Helplines can be displayed while the object is being moved. They extend from the edges of the object to the rulers at the top and left side of a drawing and do not have a snap function (Figure 63).

To use guide lines, go to **Tools > Options > LibreOffice Draw > View** on the Menu bar to open the Options LibreOffice Draw View dialog (Figure 64) and select *Helplines when moving* option or click *Helplines While Moving* in the Options toolbar.

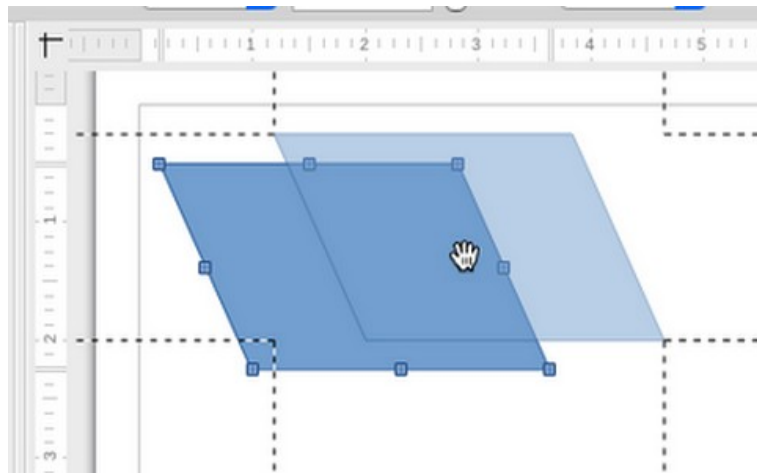

Figure 63: Helplines while moving

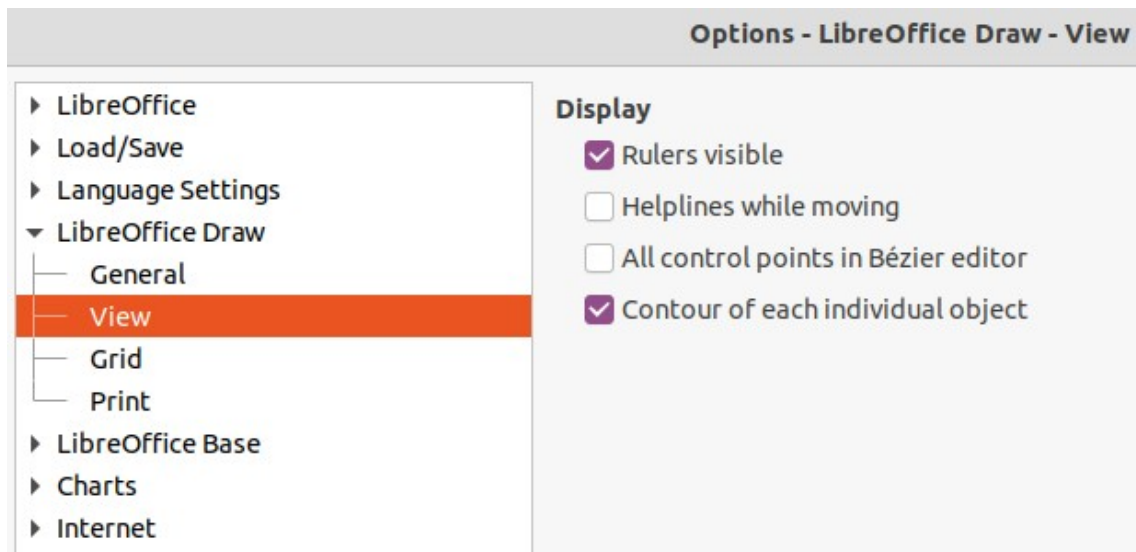

Figure 64: Options LibreOffice Draw View dialog

Changing object shape

Regular shapes

When drawing certain regular shapes, one or more dots are displayed in a different color to the selection handles when an object is selected. When the cursor hovers over one of these dots, it changes shape. Clicking and dragging on one of these dots modifies the shape of the object. For example, increasing the corner radius of a rounded rectangle or square, changes the angles of an arc, and so on.

These dots perform different functions according to the shape selected. The shapes with form changing dots and their functions are listed as follows.

Note

Regular shapes can also be changed after conversion to a curve or polygon and editing the points. See “Curves and polygons” on page 60 and “Editing points” on page 61 for more information.

Basic shapes

Refer to Figure 65 to identify the following shapes with adjustment dots.

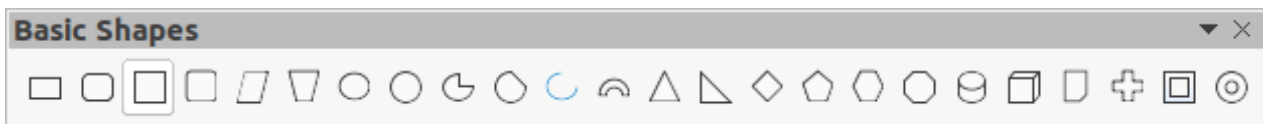

Figure 65: Basic Shapes sub-toolbar

- **Rectangle, Rounded** – use the dot to change the radius of the curve that replaces the angled corners of a rectangle or square.
- **Square, Rounded** – use the dot to change the radius of the curve that replaces the angled corners of a rectangle or square.
- **Parallelogram** – use the dot to change the internal angles between the sides.
- **Trapezoid** – use the dot to change the internal angles between the sides.
- **Circle Pie** – use the dots to change the size of the filled sector.
- **Block Arc** – use the dot to change both internal diameter and size of the filled area.
- **Isosceles Triangle** – use the dot to modify the shape and type of the triangle.
- **Hexagon** – use the dot to change the internal angles between the sides.
- **Octagon** – use the dot to change the internal angles between the sides.
- **Cylinder** – use the dot to change the perspective.
- **Cube** – use the dot to change the perspective.
- **Folded Corner** – use the dot to change the size of the folded corner.
- **Cross** – use the dot to change the thickness of the four arms of the cross.
- **Frame** – use the dot to change the thickness of the frame.
- **Ring** – use the dot to change the internal diameter of the ring.

Symbol Shapes

Refer to Figure 66 to identify the following shapes with adjustment dots.



Figure 66: Symbol Shapes sub-toolbar

- **Smiley Face** – use the dot to change the smile on the face.
- **Heart** – use the dot to change the shape of the symbol.
- **Sun** – use the dot to change the shape of the symbol.
- **Moon** – use the dot to change the shape of the symbol.
- **Prohibited** – use the dot to change the thickness of the ring and the diagonal bar.
- **Square Bevel** – use the dot to change the thickness of the bevel.
- **Octagon Bevel** – use the dot to change the thickness of the bevel.
- **Diamond Bevel** – use the dot to change the thickness of the bevel.
- **Double Bracket** – use the dot to change the curvature of the bracket.
- **Left Bracket** – use the dot to change the curvature of the bracket.
- **Right Bracket** – use the dot to change the curvature of the bracket.
- **Double Brace** – use the dot to change the curvature of the bracket.

- **Left Brace** – use the dots to change the curvature of the brace and the position of the point.
- **Right Brace** – use the dots to change the curvature of the brace and the position of the point.

Block Arrows

Refer to Figure 67 to identify the following shapes with adjustment dots.



Figure 67: Block Arrows sub-toolbar

- **Right Arrow** – use the dot to change the shape and thickness of the arrow.
- **Left Arrow** – use the dot to change the shape and thickness of the arrow.
- **Down Arrow** – use the dot to change the shape and thickness of the arrow.
- **Up Arrow** – use the dot to change the shape and thickness of the arrow.
- **Left and Right Arrow** – use the dot to change the shape and thickness of the arrow.
- **Up and Down Arrow** – use the dot to change the shape and thickness of the arrow.
- **Circular Arrow** – use the dot to change the shape and thickness of the arrow.
- **4-way Arrow** – use the dots to change the shape and thickness of the arrow.
- **Chevron** – use the dot to change the angle between the sides and the shape.
- **Pentagon** – use the dot to change the angle between the sides and the shape.
- **Striped Right Arrow** – use the dot to change the shape and thickness of the arrow.
- **Up, Right and Down Arrow** – use the dots to change the shape and thickness of the arrow.
- **Notched Right Arrow** – use the dot to change the shape and thickness of the arrow.
- **Up and Right Arrow** – use the dots to change the shape and thickness of the arrow.
- **Right Arrow Callout** – use the dots to change the shape and thickness of the callout.
- **Left Arrow Callout** – use the dots to change the shape and thickness of the callout.
- **Down Arrow Callout** – use the dots to change the shape and thickness of the callout.
- **Up Arrow Callout** – use the dots to change the shape and thickness of the callout.
- **Left and Right Arrow Callout** – use the dots to change the shape and thickness of the callout.
- **Up and Down Arrow Callout** – use the dots to change the shape and thickness of the callout.
- **4-way Arrow Callout** – use the dots to change the shape and thickness of the callout.
- **Up and Right Arrow Callout** – use the dots to change the shape and thickness of the callout.

Callouts

For all callouts (Figure 68) use the adjustment dots to change the length, position and angle of the pointer.

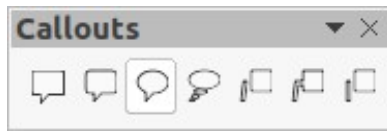

Figure 68: Callouts sub-toolbar

Stars and Banners

Refer to Figure 69 to identify the following shapes with adjustment dots.



Figure 69: Stars and Banners sub-toolbar

- **4-Point Star** – use the dot to change the thickness and shape of the star points.
- **8-Point Star** – use the dot to change the thickness and shape of the star points.
- **24-Point Star** – use the dot to change the thickness and shape of the star points.
- **Vertical Scroll** – use the dot to change the width and shape of the scroll.
- **Horizontal Scroll** – use the dot to change the width and shape of the scroll.
- **Doorplate** – use the dot to change the inward curvature of the corners.

Curves and polygons

Bézier curves

The editing of curves and polygons depends on the mathematics of Bézier curves¹. Explaining Bézier curves goes beyond this scope of this chapter. See Chapter 11, Advanced Draw Techniques for more information on drawing and manipulating Bézier curves.

The editing a Bézier curve consists in principle of moving points or tangents passing through these points. Each tangent has one control point at each end and a junction point where it meets the curve. The relative angle and distance between the control points determine the shape of the curve. Figure 70 shows what happens to a basic square and changing only one point on the square.

Converting objects to curve or polygon

When changing the shape of an object and before modifying the points on an object, it must be converted to a curve or a polygon. Depending on what kind of shape and effect required to produce using one of the following methods to create a curve or a polygon:

- After selecting an object, go to **Shape > Convert** on the Menu bar and select either **To Curve** or **To Polygon**.
- Right click on an object and select **Convert > To Curve** or **To Polygon** from the context menu.

¹ Bézier curves were invented by Pierre Bézier, who developed the technique in the 1960s and was an engineer working with the Renault car manufacturer. The technology was intended to make modeling the surface of vehicles easier.

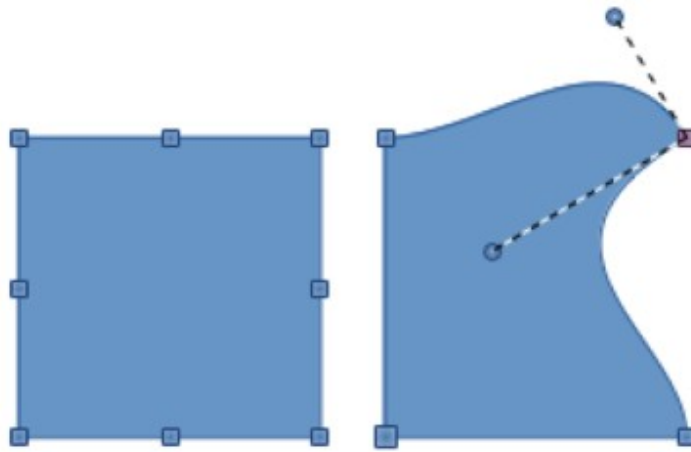

Figure 70: Creating different shapes by changing the tangent



Figure 71: Edit Points toolbar

Editing points

Many different shapes can be created by moving either the point itself, or one or both of the round handle points at either end of the tangent, as shown in Figure 70. Points can be added, deleted, or points type changed using tools available on the Edit Points toolbar (Figure 71).

After converting a shape to a curve or polygon, object points are edited as follows:

- 1) Select the object and switch to points editing mode using one of the following methods.
 - Go to **Edit > Points** on the Menu bar.
 - Click on the **Points** tool on the Standard toolbar.
 - Right click on the converted object and select **Points** from the context menu.
 - Use the keyboard shortcut **F8**.

✓ Note

After switching to points editing mode, the selection handles become points. The number of points may increase or reduce in number. This change in number depends on the shape of the object and is normal behavior.

- 2) Click on an object point to change the object shape. The Edits Points toolbar opens and the tools become active when a point is selected. Tangents also appear attached to the selected point.
- 3) Use the various tools on the Edit Points toolbar to add, delete, or change the point type.
- 4) Click on and drag the point to move the point and change the object shape.
- 5) If the selected object is a curve, click on and drag the round points at the end of a tangent to make further changes to the object shape.
- 6) When satisfied with the shape, click outside of the object to cancel points editing mode and close the Edit Points toolbar.

Point types

The available tools on the Edit Points toolbar depend on the object and type of object point that has been selected.

- **Move Points** – activates a mode allowing movement of points. Click and drag the selected point to another location. The object border follows the movement on both sides of the selected point to the next point on each side of the selected point.
- **Insert Points** – activates the insert mode and allows points to be inserted. Points can also be moved. A point is inserted onto the selected object each time the mouse button is clicked and the object changes shape to include the new point into the border of the object. The inserted point is a smooth point.
- **Delete Points** – used to delete points from the selected object. Select **Delete Points** and then click on a point to delete it. To delete several points, hold down the *Shift* key as each point is selected for deletion, then click on **Delete Points**.
- **Convert To Curve** – converts a curve into a straight line or a straight line into a curve. If a single point is selected, the curve before the point will be converted. If two points are selected, the curve between both points will be converted. If more than two points are selected and each time this icon is clicked, a different portion of the curve will be converted. If necessary, round points are converted into corner points and corner points are converted into round points.

If a section of the curve is a straight line, the end points of the line have a maximum of one control point each. They cannot be modified to round points unless the straight line is converted back to a curve.

- **Close Bézier** – closes a line or a curve. A line is closed by connecting the last point with the first point, indicated by an enlarged square.
- **Split Curve** – select the point or points where the curve will be split, then click on **Split Curve**.
- **Corner Point** – converts the selected point or points into corner points. Corner points have two movable control points, which are independent from each other. A curved line, therefore, does not go straight through a corner point, but forms a corner.

To create a corner point, a smooth or a symmetrical point must be inserted first and then converted to a corner point by clicking on **Corner Point**.

- **Smooth Transition**-- converts a corner point or symmetrical point into a smooth point. Both control points of the corner point are aligned in parallel, and can only be moved simultaneously. The control points may differentiate in length, allowing variation in the degree of curvature.
- **Symmetric Transition** – converts a corner point or a smooth point into a symmetrical point. Both control points of the corner point are aligned in parallel and have the same length. They can only be moved simultaneously and the degree of curvature is the same in both directions.
- **Eliminate Points** – marks selected points for deletion. This happens if the point is located on a straight line. If converting a curve or a polygon using **Convert to Curve** into a straight line or alter a curve using the cursor so that a point lies on the straight line, the selected point is removed. The angle from which the point reduction is to take place is 15° by default.

Tangents

Before using tangents on an object, the object must be converted to a curve. Tangents are only used on curves. If an object has been converted to a polygon and a tangent is added, the object is automatically converted to a curve.

✓ Note

The angle that a tangent relates to an object shape can be changed by clicking on one of the tangent control points at the end of a tangent and moving it with the cursor. As the tangent angle is changed, the shape of the object changes in response.

Symmetric transition

Symmetric transition converts a corner point or a smooth point into a symmetrical point. The tangents have the same length and are aligned in a straight line, as shown in Figure 72. The tangents can only be moved simultaneously and the degree of curvature is the same in both directions.

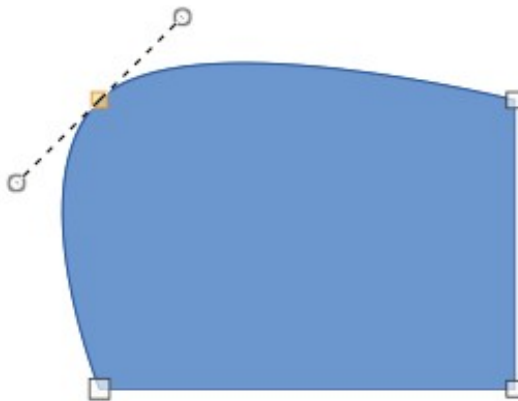

Figure 72: Symmetric transition

- 1) Convert the object to a curve or polygon.
- 2) Switch the selected object into editing points mode and open the Edit Points toolbar.
- 3) Select the point to be changed to a symmetrical point.
- 4) Click on **Symmetric Transition** in the Edit Points toolbar. The straight line on each side of the symmetric transition point is converted to a curve.
- 5) Click and drag one of the tangent control handles to change the curvature and shape of the object. Any change to one tangent is carried over symmetrically to the other tangent.

Smooth transition

Smooth transition converts a corner point or symmetrical point into a smooth point. The tangents are aligned in a straight line and can only be moved simultaneously. The tangents can have different lengths with the curvature controlled by the longest tangent being the largest curvature, as shown in Figure 73.

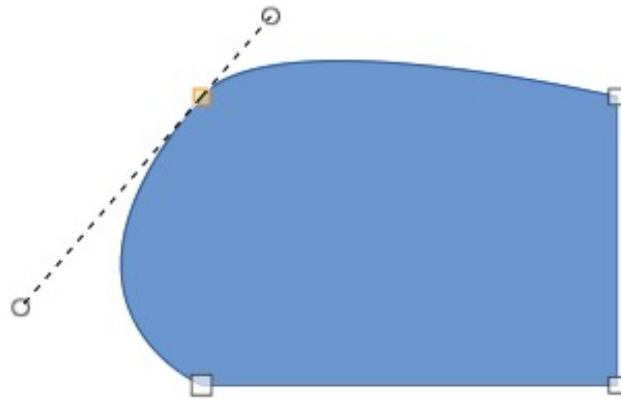

Figure 73: Smooth transition

- 1) Convert the object to a curve or polygon.
- 2) Switch the selected object into editing points mode and open the Edit Points toolbar.
- 3) Select the point to be changed to a symmetrical point.
- 4) Click on **Smooth Transition** on the Edit Points toolbar.
- 5) Click and drag one of the tangent control handles to change the shape of the object. This creates an asymmetric tangent with the largest curvature on the longest side of the tangent.

Corner point

Converts a selected point or points into corner points. Corner points have two movable control points, which are independent from each other. It is possible to independently change the angle on each side of a tangent using the central point of the tangent as a corner point, as shown in Figure 74.

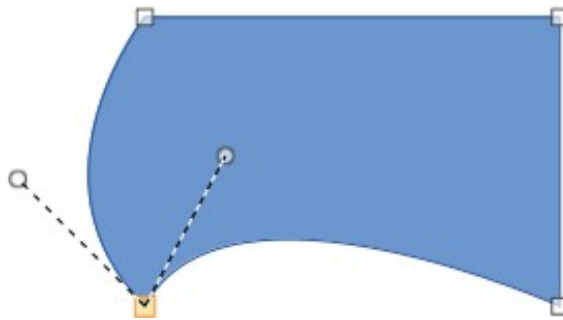

Figure 74: Corner point

- 1) Convert the object to a curve or polygon.
- 2) Switch the selected object into editing points mode and open the Edit Points toolbar.
- 3) Select the point to be changed to a symmetrical point.
- 4) Click on **Corner Point** on the Edit Points toolbar.
- 5) Click and drag the end of one of the tangents to change its angle. Each tangent can be moved independently to create spikes and troughs in an object shape.

Points

Moving points

When moving points, the object border on both sides of the point follows the movement of the point changing the object shape.

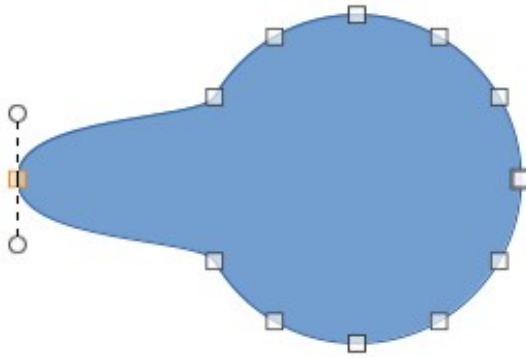

Figure 75: Moving points

- 1) Convert the object to a curve or a polygon.
- 2) Switch the selected object into editing points mode and open the Edit Points toolbar.
- 3) Select the point to be changed to a symmetrical point.
- 4) Click on **Move Points** on the Edit Points toolbar.
- 5) Place the cursor on the selected point, then click and drag the point to create a new shape. Figure 75 illustrates how a different shape can be created from a circle by dragging the left hand side point to the left.

Inserting points

A point is inserted onto the selected object each time the mouse button is clicked. Clicking inside the border of the object, the object changes shape to include the new point into the border of the object, as shown in Figure 76. The inserted point is a smooth point.

Points can also be moved in insert point mode. Hover the cursor over the point until it changes shape, then click and drag the point to change the object shape.

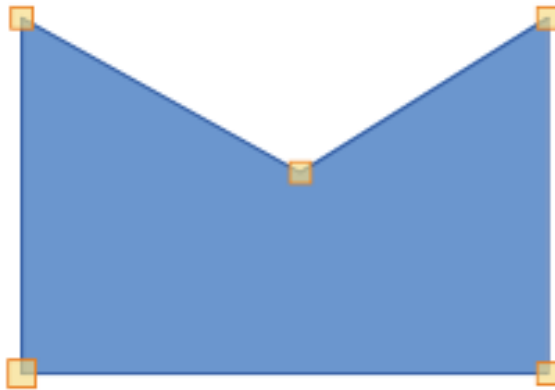

Figure 76: Inserting points

- 1) Convert the object to a curve or a polygon.
- 2) Switch the selected object into editing points mode and open the Edit Points toolbar.
- 3) Click on **Insert Points** on the Edit Points toolbar.
- 4) Click on the object border to insert a point at the required position on the border.
- 5) Alternatively, click inside the object border to insert a point. The object automatically changes shape to include the new point into the object border.

Deleting points

Figure 77 shows what happens when three points on the left were deleted from a circle. The left image is a the full circle and the right image is where three points have been deleted creating a new shape.

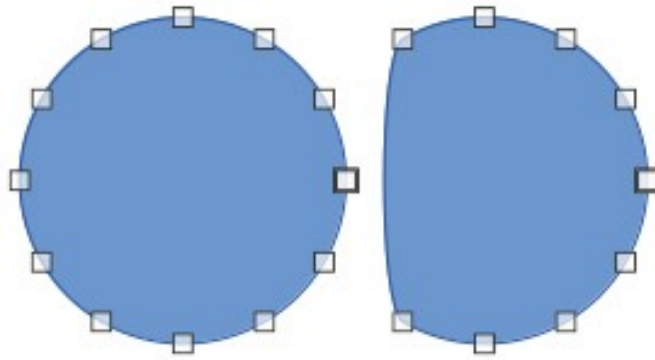

Figure 77: Deleting points

- 1) Convert the object to a curve or a polygon.
- 2) Switch the selected object into editing points mode and open the Edit Points toolbar.
- 3) To delete a single point, proceed as follows
 - a) Select the point for deletion.
 - b) Click on **Delete Points** on the Edit Points toolbar.
- 4) To delete several points at the same time, proceed as follows:
 - a) Hold down the *Shift* key.
 - b) Select all the points for deletion.
 - c) Click on **Delete Points** on the Edit Points toolbar.

Eliminating points

The **Eliminate Points** tool on the Edit Points toolbar only functions on lines with multiple points. These lines are created when a curve is converted to a line using the **Convert to Curve** tool. An example of creating a straight line and eliminating points is shown in Figure 78.

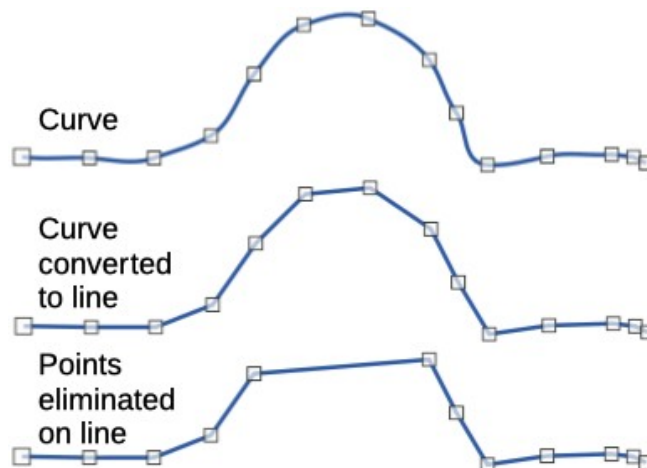

Figure 78: Converting curve to line and eliminating points

- 1) Convert the curve to a curve or a polygon.
- 2) Switch the curve into editing points mode and open the Edit Points toolbar.
- 3) Select the curve with multiple points and convert to a line, see "Converting curves or lines" below.
- 4) Select the point or points on the line for elimination. The selected point is emphasized.
- 5) Select the **Eliminate Points** tool on the Edit Points toolbar.

- 6) Accurately position the cursor over the selected point, then click and drag the selected point. As the cursor is dragged, a dotted line forms between the neighboring points.
- 7) When this dotted line appears to be a straight line between the neighboring points, release the mouse button. The selected point is eliminated and a straight line now exists between the neighboring points.

Converting curves or lines

Curves and lines are easily converted using the **Convert to Curve** tool on the Edit Points toolbar. When a curve is converted to a line, a straight line is created between selected points on a curve. When a line is converted to a curve, a curve is created between selected points on a line. An example of converting a curve to a line is shown in Figure 78.

- 1) Convert the object to a curve or a polygon.
- 2) Switch the object into editing points mode and open the Edit Points toolbar.
- 3) Select the points for converting from curve to line or from line to curve.
- 4) Click on **Convert to Curve** on the Edit Points toolbar. Between the selected points, a curve is converted into a line or a line is converted into a curve.

Splitting objects

- 1) Convert the object to a curve or a polygon.
- 2) Switch the object into editing points mode and open the Edit Points toolbar.
- 3) Select the point or points on the object where it is to be split. Keep the *Shift* key pressed down when selecting more than one point.
- 4) Click on **Split Curve** on the Edit Points toolbar to split or cut the object border at the selected point. If the object is filled, it will be emptied because the object border is no longer closed, as shown in Figure 79.
- 5) Deselect the object, then drag the cut segment and move it away from the original object.

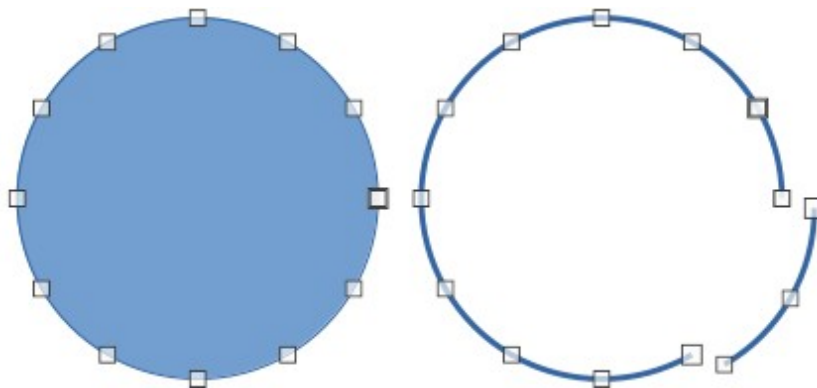

Figure 79: Splitting objects

✓ Note

The point where the object was split is now larger than the remaining points visible on the object.

Closing objects

- 1) Select an open object (Figure 80).
- 2) Switch the object into editing points mode and open the Edit Points toolbar.

- 3) Select a point where the object has been split. Note that the start point of an object is larger than the other points visible on the object.
- 4) Click on **Close Bézier** in the Edit Points toolbar to close the object. If the open object was originally a closed and filled object, then the original color fills the object when it is closed.

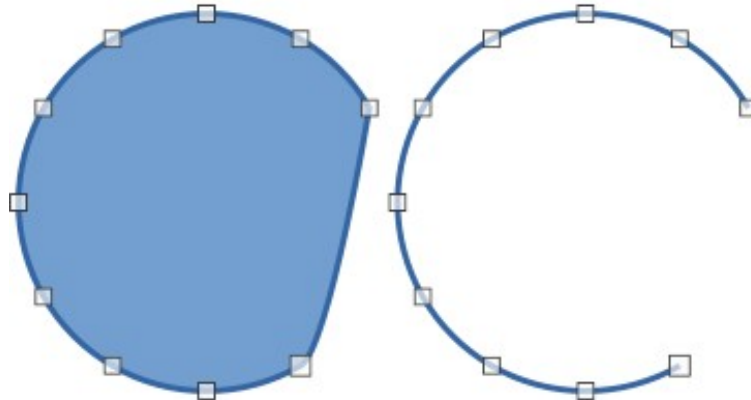

Figure 80: Closing objects

Distorting objects

- 1) Select the object and switch into editing points mode to display the points on the object. This also opens the Edit Points toolbar.
- 2) Select one of the points on the object and drag it to a new position to distort the object (Figure 81).

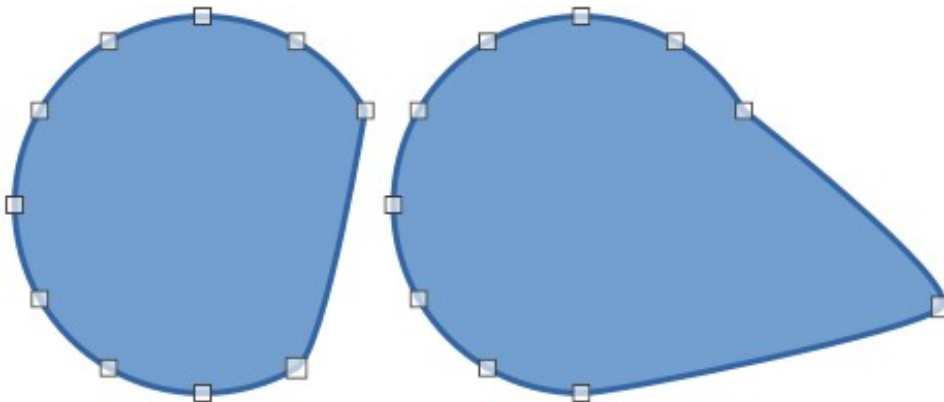

Figure 81: Distorting objects



LibreOffice
Community



Draw Guide 7.2

Chapter 4, Changing Object Attributes

Formatting lines

In LibreOffice the term *Line* indicates a freestanding segment (line), the outer edge of a shape (border), or an arrow. In most cases, the properties of the line that can be modified are its style (solid, dashed, invisible, and so on), its width, its color and the type of arrowhead.

Tip

Hovering the cursor over a tool icon on a toolbar or in the Sidebar, a pop up displays the name of the tool.

Note

For more information on using color when formatting lines, line styles, arrows, and arrow styles, see “Working with area fills” on page 81.

Line and Filling toolbar

Format a line using the Line and Filling toolbar (Figure 82) as follows:

- 1) Make sure the line is selected in a drawing.
- 2) Select the line style required from the **Line Style** drop-down list.
- 3) Either type the line width in the **Line Width** text box, or use the up and down arrows to change the line width.
- 4) Click on the triangle ▼ to the right of **Line Color** and select a color from one of the available color palettes.
- 5) Click on the triangle ▼ to the right of **Line Style** and select a line style from one of the options in the drop-down list.
- 6) If necessary, select from the **Arrow Style** drop-down list the type of arrowhead for each end of the line and change the line into an arrow. The left drop-down list adds an arrow head to the beginning of the line. The right drop-down list adds an arrow head to the end of the line.
- 7) If necessary, click on **Shadow** to add a shadow to the line. The shadow applied uses the settings set in the Line dialog (Figure 87 on page 73).
- 8) Deselect the line to save the changes to the line.

Sidebar

Format a line using the **Line** panel in the Properties deck on the Sidebar (Figure 83) as follows:

- 1) Make sure the line is selected in a drawing.
- 2) Click on **Properties** on the Sidebar to open the Properties deck.
- 3) Click on **Line** to open the **Line** panel.

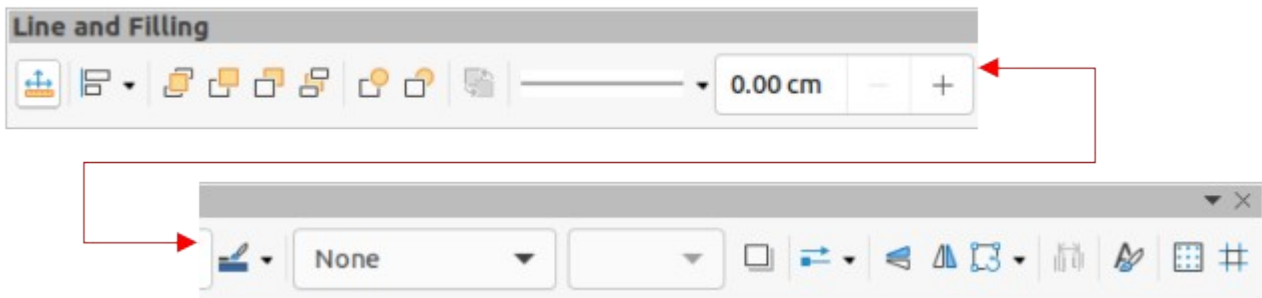

Figure 82: Line and Filling toolbar

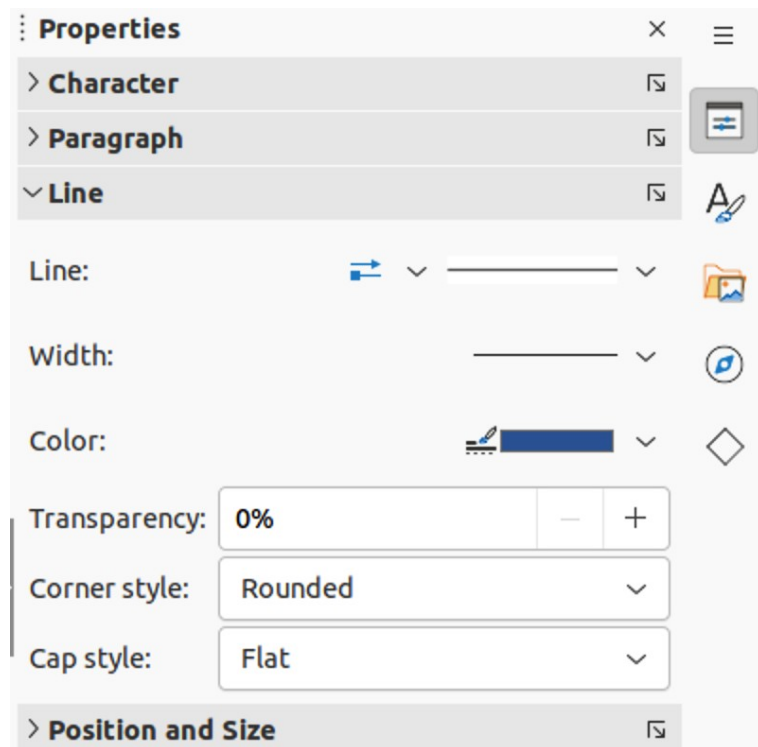

Figure 83: Line panel in Properties deck on Sidebar

- 4) In *Line*, select from the **Arrow Style** drop-down lists the type of arrowhead for each end of the line and change the line into an arrow. The left drop-down list adds an arrowhead to the beginning of the line. The right drop-down list adds an arrowhead to the end of the line.
- 5) In *Line*, select the type of line required from the **Line Style** drop-down list.
- 6) In *Width*, select the line width from the **Width** drop-down list or enter a width in the **Custom Line Width** text box.
- 7) In *Color*, click on the triangle ▼ to the right of **Line Color** and select a color from one of the available color palettes.
- 8) In *Transparency*, enter a percentage for the amount of transparency for the line.
- 9) In *Corner style*, select a corner style from the drop-down list.
- 10) In *Cap style*, select a cap style from the drop-down list.
- 11) Deselect the line to save the changes to the line.
- 12) If necessary, click on **More Options** on the right of the title bar and open the Line dialog for more control over formatting lines.

Line dialog

To fully change the appearance of a line, use the Line dialog.

- 1) Make sure a line is selected on a slide.
- 2) Open the Line dialog (Figure 84) using one of the following methods:
 - Go to **Format > Line** on the Menu bar.
 - Right-click on the line and select **Line** from the context menu.
 - Click on **More Options** on the right of the *Line* panel title on the Sidebar.

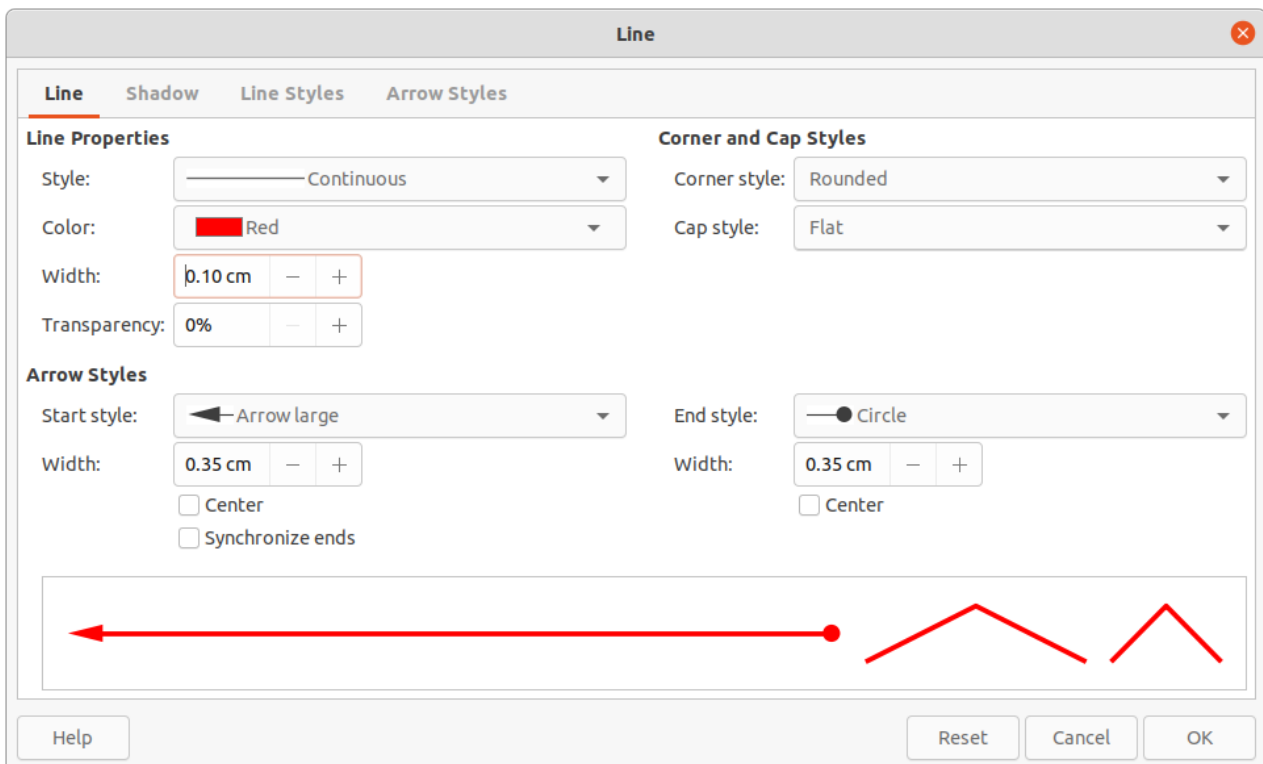

Figure 84: Line dialog - Line page

- 3) Use the options available in the pages of the Line dialog to format the line. The pages are **Line**, **Shadow**, **Line Styles** and **Arrow Styles** and the options available are explained in the following sections. The preview box at the bottom of the dialog shows the effect of the changes on a line.
- 4) Click **OK** to save the changes and close the dialog.

Line properties

The **Line** page in the Line dialog is where the basic parameters of the line are set. It is divided into three sections as follows.

- **Line properties** – this section sets the following parameters:
 - *Style* – select a line style from the drop-down list.
 - *Color* – select a predefined color from one of the available color palettes.
 - *Width* – specifies the thickness of the line.
 - *Transparency* – sets the transparency of a line. Figure 85 shows the effects of different percentages in transparency levels to lines when placed over an object.

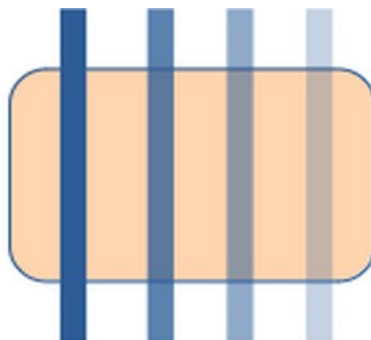

Figure 85: Line transparency (0%, 25%, 50%, 75%)



Figure 86: Default arrow top; centered arrow bottom

- **Arrow Styles** – this section is only applicable to individual lines and is not used for lines that form the borders of an object.
 - *Start style* and *End style* – select from the drop-down list an arrow style or arrowhead for the start and end of a line.
 - *Width* – specifies the thickness of the arrow endings
 - *Center* – moves the center of the arrow endings to the end point of the line. Figure 86 shows the effects of selecting this option.
 - *Synchronize ends* – makes the two line ends identical.
- **Corner and Cap Styles** – determines how the connection between two segments of a line looks. To appreciate the difference between these styles, choose a thick line style and observe how the preview changes.
 - *Corner style* – select the shape to be used at the corners of the line. For a small angle between lines, a mitered shape is replaced with a beveled shape.
 - *Cap style* – select the style of the line end caps. The caps are added to inner dashes as well.

Line shadows

The **Shadow** page (Figure 87) of the Line dialog provides the options to add and format a shadow to a selected line. The settings on this dialog page are the same as those for shadows applied to other objects, described in “Working with shadows” on page 96.

To quickly apply a shadow to a line, click on **Shadow** on the Line and Filling toolbar. Using the **Shadow** tool creates a shadow using the settings from the **Shadow** page in the Line dialog.

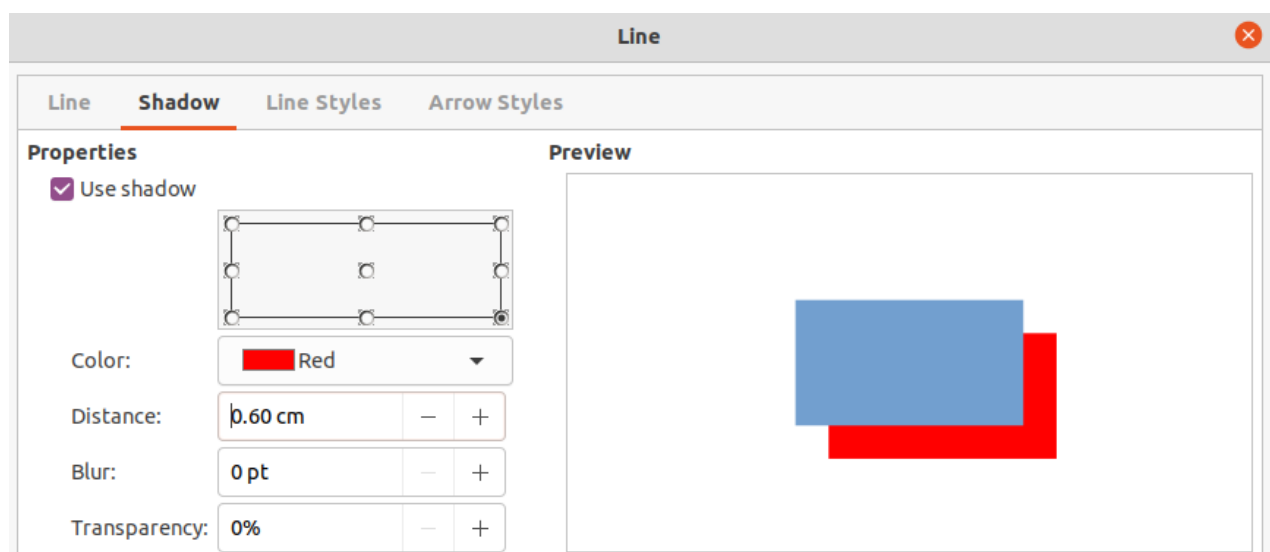

Figure 87: Line dialog - Shadow page

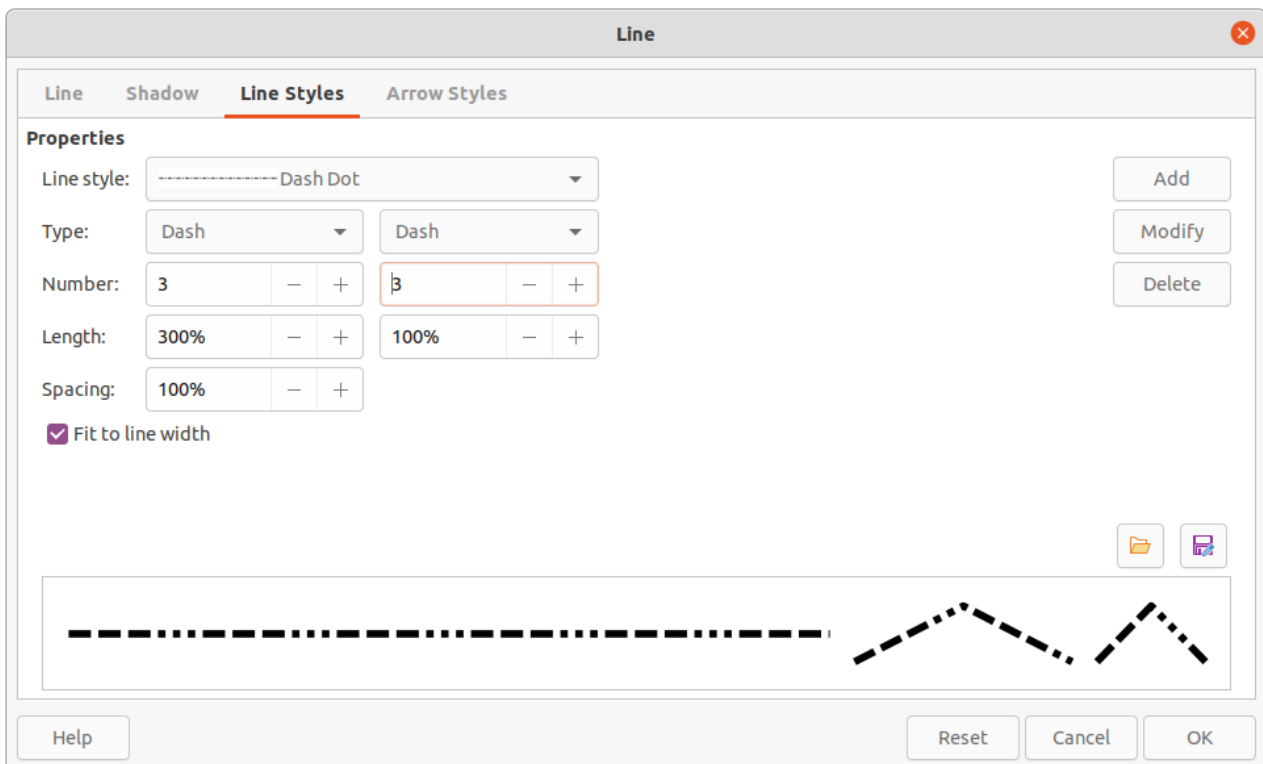

Figure 88: Line dialog - Line Styles page

Line styles

Line styles are useful in a drawing when adding several lines of similar types. This reduces the need to format individual lines. LibreOffice provides standard line styles that can be used in a drawing. Also, line styles can be created, saved, and deleted.

The **Line Styles** page in the Line dialog (Figure 88) provides the options to use predefined line styles and to create or change line styles.

Creating line styles

- 1) Create a line in a drawing.
- 2) Open the Line dialog using one of the following methods:
 - Go to **Format > Object and Shape > Line** on the Menu bar.
 - Right-click on the line and select **Line** from the context menu.
- 3) Click on the **Line Styles** tab to open the **Line Styles** page.
- 4) In the *Line style* drop-down list, select a pre-defined line style similar to the style to be created. An example of the line style selected is displayed at the bottom of the dialog page. This example changes as changes are made to the line style.
- 5) In the *Type* drop-down menus, select either **Dots** or **Dash**. To use only one type for the line, select the same type in both *Type* boxes. To alternate the two line types within a single line, select different types in the two *Type* boxes.
- 6) In the *Number* boxes, specify the number of each line type selected in *Type*. For different sized groups of dots or dashes, set a different quantity in each *Number* box.
- 7) In the *Length* boxes, specify the **Dash** length as a percentage of the line. The *Length* option is not available for **Dots**.
- 8) In the *Spacing* box, specify the spacing between the dashes and/or dots as a percentage of the line. The *Spacing* option is not available when the option *Fit to line width* is selected.

- 9) If necessary, select *Fit to line width* so that the new style fits the line width when that line is created in a drawing.
- 10) For the current document only, create a new line style, or modify a line style as follows. To use the new or modified line style in other drawings, the line style must be saved using **Save Line Styles**. See "Saving line styles" below for more information.
 - a) Click on **Add** or **Modify** to open the Name dialog.
 - b) Enter a unique name for the new or modified line style.
 - c) Click on **OK** to save the new or modified line style and close the Name dialog.
- 11) Click on **OK** to close the Line dialog and the new line style is ready for use in the current drawing only.

Note

When creating or modifying a line style, it is recommended to use a unique name for the line style. This prevents one of the standard line styles in LibreOffice from being overwritten and causing formatting problems in other drawings or documents that use the standard line styles.

Saving line styles

Saving a line style allows for a newly created line style to be used in other LibreOffice drawings.

- 1) Create a new line style, described in "Creating line styles" above, but do not close the Line dialog.
- 2) Click on **Save Line Styles** at the bottom right of the **Line Styles** page to open a file browser window at the correct location for line styles.
- 3) Enter a unique filename using the extension `.sod` for the line style in the *Name* box.
- 4) Click on **Save** to save the line style and close the file browser window. The new line style is now available for use in new drawings and documents.

Loading line styles

Standard line styles are provided when LibreOffice is installed on a computer. However, compatible line styles can be loaded and used in LibreOffice. Any line styles loaded into LibreOffice must use the file extension `.sod`.

- 1) Create a line in a drawing.
- 2) Open the Line dialog and click on the **Line Styles** tab to open the **Line Styles** page.
- 3) Click on **Load Line Styles** at the bottom right of the **Line Styles** page to open a file browser window at the correct location for line styles.
- 4) Select a style from the list of saved styles in the file browser window. The file extension for line styles is `.sod`.
- 5) Click **Open** to load the line style into LibreOffice. The line style becomes available for other LibreOffice drawings and documents.
- 6) Click **OK** to close the Line dialog and save any changes made.

Deleting line styles

- 1) Open the Line dialog and click on the **Line Styles** tab to open the **Line Styles** page.
- 2) Select the line style for deletion from the *Line style* drop-down list.
- 3) Click on **Delete** and confirm the deletion by clicking on **Yes** in the confirmation dialog.
- 4) Click **OK** to close the Line dialog and save any changes made.

✓ Note

When deleting line styles, make sure that the line style is not used in another document. It is recommended to only delete line styles that have been created and not to delete one of the LibreOffice predefined line styles. This prevents any formatting problems in other documents where the line style has been used.

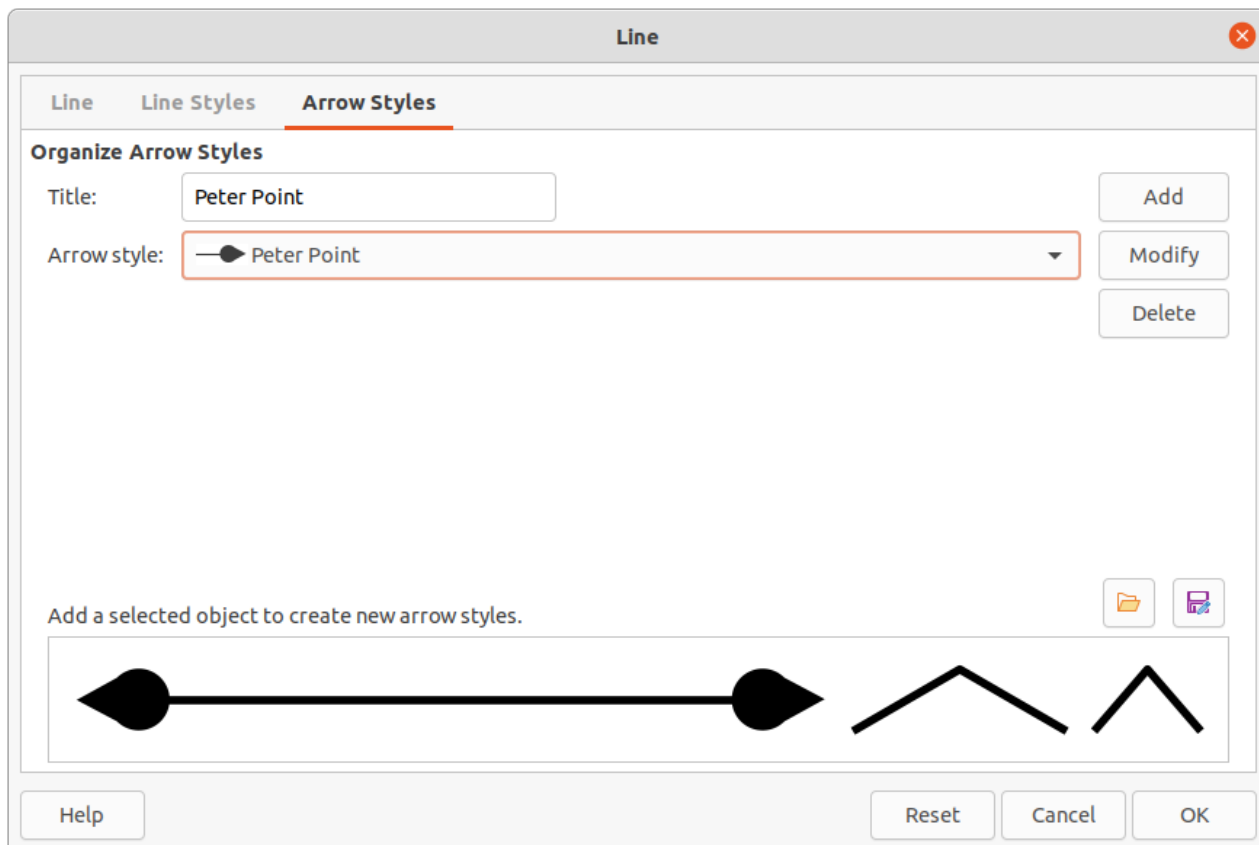

Figure 89: Line dialog - Arrow Styles page

Arrow styles

Use the Arrow Styles page (Figure 89) in the Line dialog to create new arrow styles, modify existing arrow styles, or load previously saved arrow styles.

Creating arrow styles

Any shape can be used as an arrowhead, but the shape must be convertible to a curve. A curve is something drawn without lifting a pencil. For example, a star can be converted to a curve, but a smiley face cannot.

✓ Note

The part of the shape being used as the point of the arrowhead must be at the top of the shape when creating a new arrowhead. If necessary, rotate the shape until the point is at the top of the shape.

- 1) Select a shape, or create a shape that can be converted to a curve for use as a new arrowhead. The part of the shape that is going to be point of the arrowhead must face upward. An example of a new arrowhead is shown in Figure 90.



Figure 90: Example shape being used for an arrowhead

- 2) Select the shape and convert to a curve using one of the following methods:
 - Right-click on the shape and select **Convert > To Curve** from the context menu.
 - Go to **Shape > Convert > To Curve** on the Menu bar.
- 3) With the shape selected, open the **Arrow Styles** page in the Line dialog.
- 4) Click on **Add** and type a unique name for the new arrow style in the Name dialog that opens, then click **OK**. The new arrowhead style is displayed in the preview box of the Line dialog and at the bottom of the *Arrow style* drop-down list.
- 5) Click **OK** to save the changes and close the Line dialog. The new arrow style is available only in the current document.

✓ **Note**

Some shapes cannot be used as an arrowhead. This is indicated by rectangular blocks appearing at each end of the line in the preview box on the **Line Styles** page in the Line dialog.

✓ **Note**

When creating an arrow style, it is recommended to use a unique name for the arrow style. This prevents one of the standard arrow styles in LibreOffice from being overwritten and causing formatting problems in other drawings that use the standard arrow styles.

✓ **Note**

The new arrow style created is available only for use in the current drawing. To use the new arrow style in other drawings, the arrow style must be saved using the **Save Arrow Styles** option.

Saving arrow styles

Saving an arrow style allows for the newly created style to be used in other LibreOffice documents.

- 1) Create a new arrow style as described in “Creating arrow styles” above, but do not close the Line dialog.

- 2) Click on the **Save arrow styles** icon at the bottom right of the **Arrow Styles** page to open a file browser window at the correct location for arrow styles.
- 3) Enter a unique filename using the extension `.soe` for the arrow style.
- 4) Click on **Save** to save the arrow style and close the file browser window. The new arrow style is now available for use in new documents.

Loading arrow styles

LibreOffice provides standard arrow styles when installed on a computer. However, compatible arrow styles can be loaded and used in LibreOffice. Any arrow styles loaded into LibreOffice must use the file extension `.soe`.

- 1) Open the Line dialog and click on the **Arrow Styles** tab to open the **Arrow Styles** page.
- 2) Click on the **Load arrow styles** icon at the bottom right of the **Arrow Styles** page to open a file browser window at the correct location for arrow styles.
- 3) Select an arrow style from the list of saved styles in the file browser window
- 4) Click **Open** to load the arrow style into the drawing. The arrow style also becomes available for other LibreOffice documents.
- 5) Click **OK** to close the Line dialog and save any changes made.

Deleting arrow styles

- 1) Open the Line dialog and click on the **Arrow Styles** tab to open the **Arrow Styles** page.
- 2) Select the arrow style for deletion from the *Arrow style* drop-down list.
- 3) Click on **Delete** and confirm the deletion by clicking on **Yes** in the confirmation dialog that opens.
- 4) Click **OK** to close the Line dialog and save any changes made.



Note

When deleting arrow styles, make sure that the arrow style is not used in another document. It is recommended to only delete arrow styles that have been created and not to delete one of the LibreOffice predefined arrow styles. This prevents any formatting problems in other documents where the arrow style has been used.

Formatting area fills

Area fill refers to the inside of an object that has an unbroken border, for example a rectangle, circle, star, pentagon and so on. An area fill can be none, a uniform color, gradient, hatching, bitmap or pattern, as shown in Figure 91. Also, an area fill can be made partly or wholly transparent and can throw a shadow.

Line and Filling toolbar

Tools on the Line and Filling toolbar provide a range of default fills readily available to quickly format graphic objects. If this toolbar is not showing, go to **View > Toolbars > Line and Filling** on the Menu bar. To format the area of an object:

- 1) Select an object so that the selection handles are displayed.
- 2) Click on **Area Style/Filling** on the Line and Filling toolbar and select the type of fill required from the drop-down list.
 - **None** – select this option if an area fill for an object is not required.
 - **Color** (Figure 92) – select a color palette from the available options in the drop-down list, then select a color by clicking on the color.

- **Gradient** (Figure 93) – select the required gradient from the drop-down list.
 - **Hatching** (Figure 94) – select the required hatching from the drop-down list.
 - **Bitmap** (Figure 95) – select the required bitmap from the drop-down list.
 - **Pattern** (Figure 96) – select the required pattern from the drop-down list.
- 3) Deselect the object to save the changes to the object.

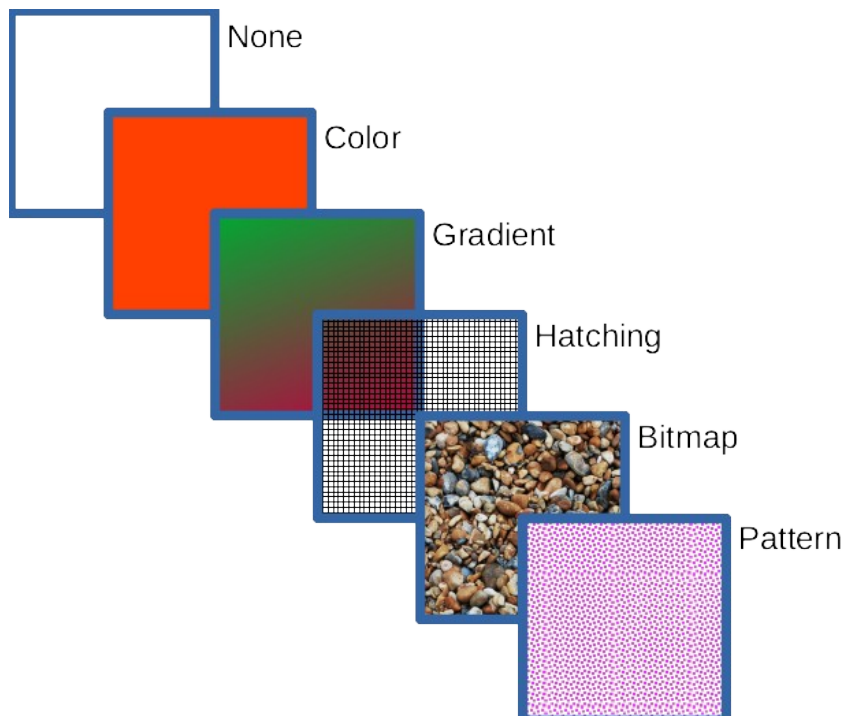

Figure 91: Examples of area fill types

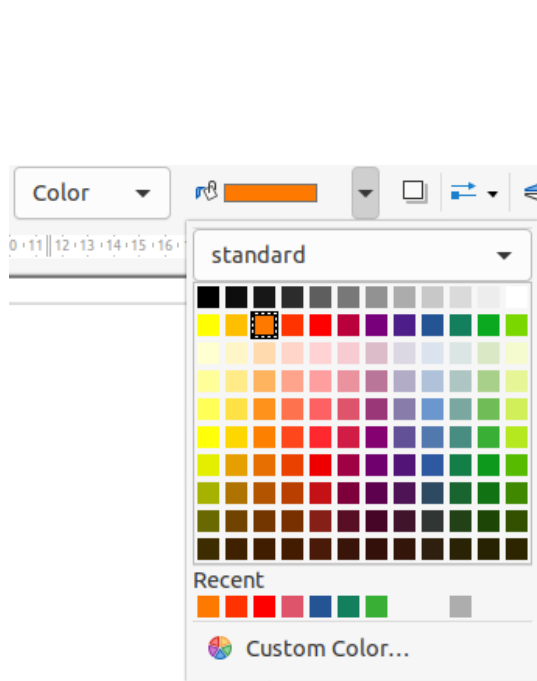

Figure 92: Color area fills

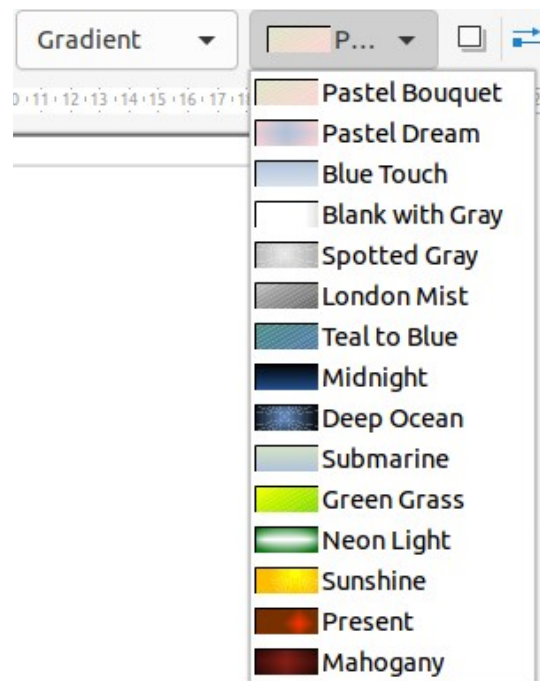

Figure 93: Gradient area fills

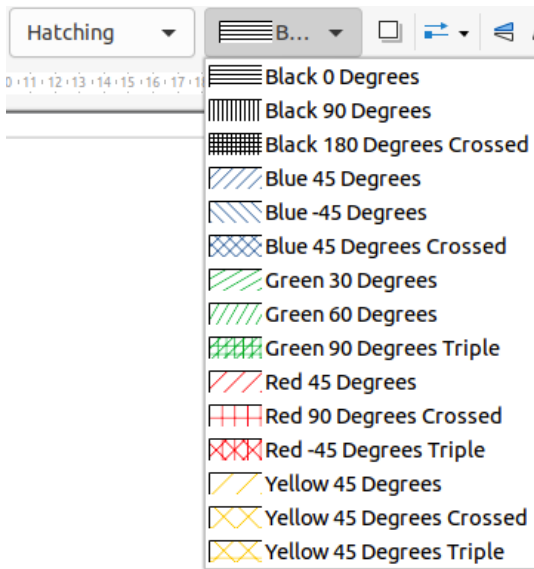

Figure 94: Hatching area fills

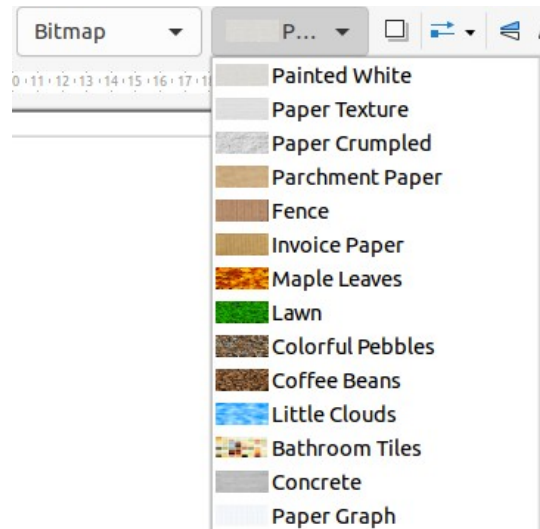

Figure 95: Bitmap area fills

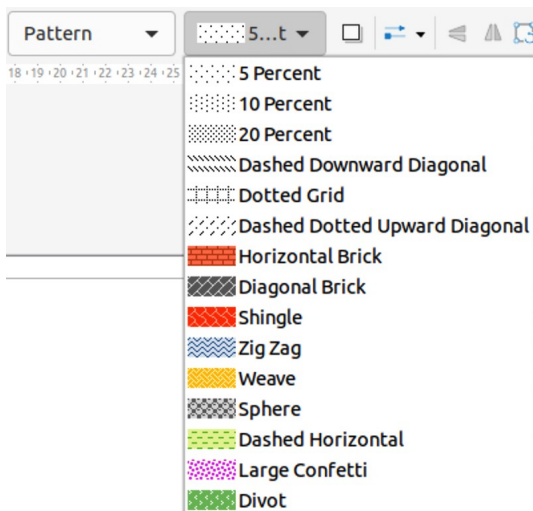

Figure 96: Pattern area fills

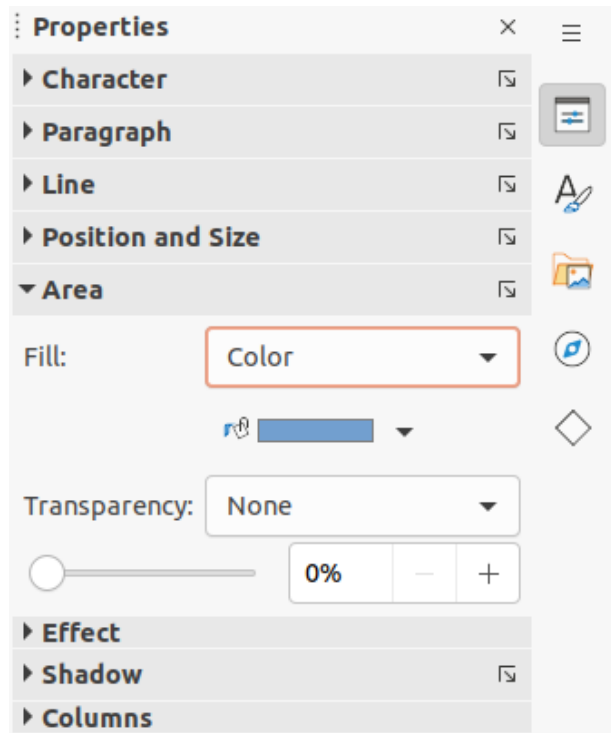

Figure 97: Area panel in Properties deck on Sidebar

Sidebar

Format the area of an object using the Sidebar (Figure 97) as follows:

- 1) Make sure an object with an area fill is selected in a drawing.
- 2) Click on **Properties** on the Sidebar, then click on the down arrowhead v on the left of the **Area** titlebar to open the **Area** panel.
- 3) Use the options in the *Fill* and *Transparency* drop-down lists to format the area of an object.
- 4) Deselect the object to save the changes.

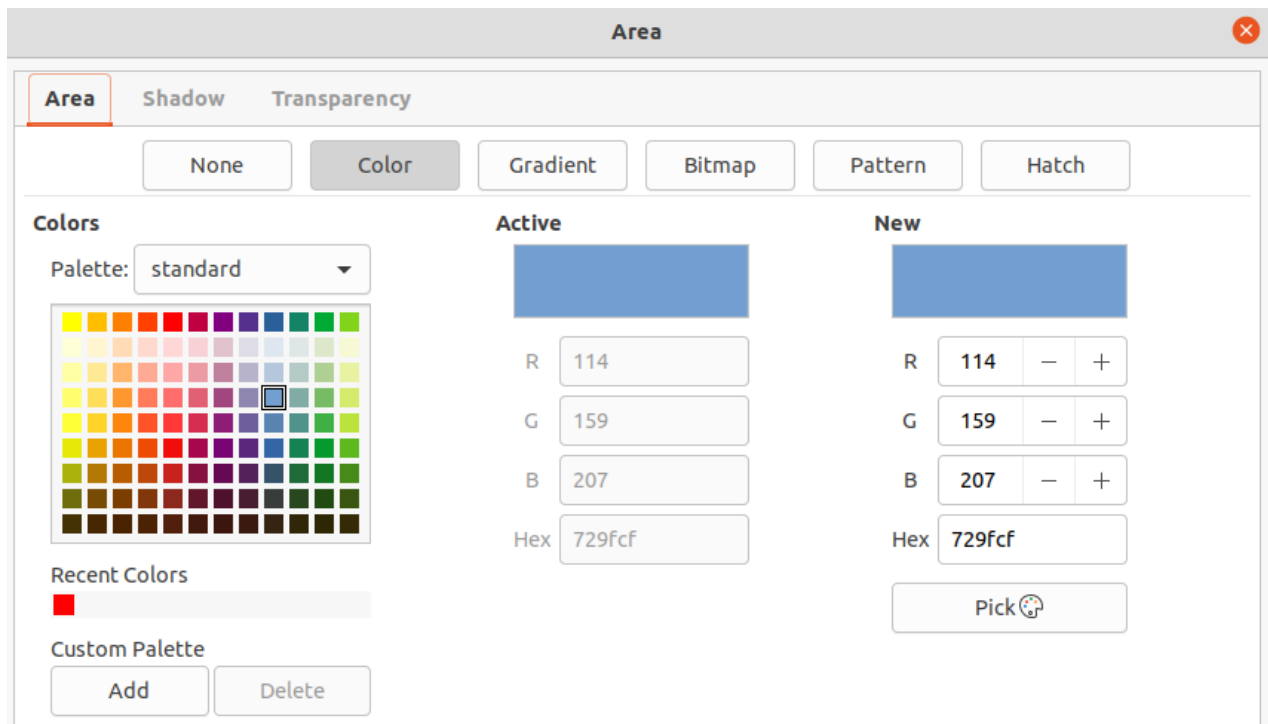

Figure 98: Area dialog - Area Color page

Area dialog

Format area fills with greater control using the Area dialog (Figure 98) as follows:

- 1) Make sure the object is selected in a drawing.
- 2) Open the Area dialog using one of the following methods:
 - Go to **Format > Area** on the Menu bar.
 - Click on **Area** in the Line and Filling toolbar.
 - Right-click on the selected object and select **Area** from the context menu.
 - Click on **More Options** on the right of the Area section title on the Sidebar.
- 3) Click on the **Area** tab to open the Area page.
- 4) Select the type of area fill from the available options (*None, Color, Gradient, Bitmap, Pattern, or Hatch*)
- 5) Select the style of area fill from the options that become available for each type of area fill selected.
- 6) Click **OK** to close the Area dialog and save the changes.

Working with area fills

Color fills

Selecting color fill

The following procedure to select a color for an area fill uses the Area dialog. Using the tools on the Line and Filling Toolbar, and the Area section in the Properties deck on the Sidebar is a similar procedure, but the available options are reduced. All color fills are solid colors.

- 1) Make sure the object is selected in a drawing.
- 2) Open the Area page on the Area dialog, then click on *Color* to open the options available for a color fill.

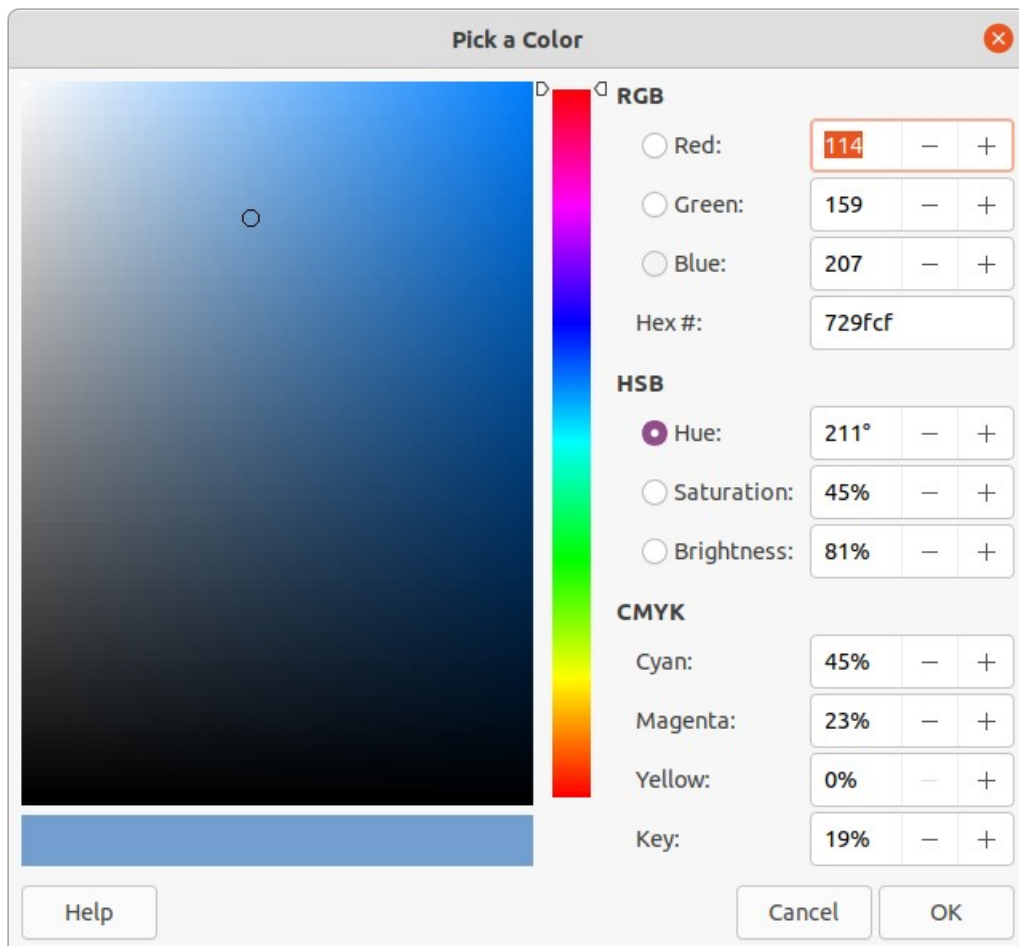

Figure 99: Pick A Color dialog

- 3) In **Colors**, select the required palette from the available options in the *Palette* drop-down list.
- 4) Click on the color required. All color fills available are solid colors.
 - **Active** preview box – shows the present color fill of a selected object. After selecting a color, a preview of the selected color appears in the **New** preview box.
 - Alternatively, enter the *RGB* or *Hex* values of a color in the appropriate text box.
 - Alternatively, click on **Pick** to open the Pick a Color dialog (Figure 99). Select a color from the color box or enter the *RGB*, *Hex*, *HSB* or *CMYK* values for the color required.
 - If a color has been used before, then select the required color from those available in *Recent Colors*.
- 5) If necessary and to revert back to the original color, click on **Reset** and any changes made are removed.
- 6) Click **OK** to close the Area dialog and save the changes. The color area fill is then changed in the selected object.

Creating custom colors using Area dialog

- 1) Select a filled object to create a color.
- 2) Open the Area dialog and click on **Area** to open the **Area** page, then click on **Color** to open the options available for a color fill.
- 3) Specify the values of Red (R), Green (G), and Blue (B) on a 0 to 255 scale, or the percentages of Cyan (C), Magenta (M), Yellow (Y), and Black (K) to create a new color.

- 4) Click on **Add** in *Custom Palette* and enter a name for the color in the Name dialog that opens.
- 5) Click **OK** to close the Name dialog and the color is added to the *Custom* palette.
- 6) Click **OK** to close the Area dialog and save the changes. The new custom color appears as a fill in the selected object and is available for use in other drawings or documents.

Creating custom colors using *Pick a Color* dialog

- 1) Select a filled object to create a color.
- 2) Open the *Pick a Color* dialog (Figure 99) using one of the following methods:
 - Click on **Pick** on the Colors page of the Area dialog.
 - Click on the triangle ▼ next to **Fill Color** on the Line and Filling toolbar and select *Custom Color*.
 - Click on the triangle ▼ next to **Fill Color** in the *Area* section of the Properties deck on the Sidebar and select *Custom Color*.
- 3) Create a custom color using one of the following methods. A preview of the color created is shown in the colored box below the original color on the left side of the dialog.
 - Select a color range from the colored bar, then, using the mouse, move the target in the colored box until the cursor is on the color required.
 - Enter values for *Red* (R), *Green* (G), and *Blue* (B) in the **RGB** text boxes.
 - Enter values for *Cyan* (C), *Magenta* (M), *Yellow* (Y), and *Key* (K) (black) in the **CMYK** text boxes.
 - Enter values for *Hue* (H), *Saturation* (S), and *Brightness* (B) in the **HSB** text boxes. HSB values do not change the color, but how a color looks.
 - If known, enter the *Hex#* number in the text box. For example, Hex numbers are normally used when a specific color has been created for a company logo or company name.

Note

Changing one set of color values also changes the color values in the other sets.

- 4) Click **OK** to close the *Pick a Color* dialog and save the changes.
- 5) Click on **Add** in *Custom Palette* and enter a name for the color in the Name dialog that opens.
- 6) Click **OK** to close the Name dialog and the color is added to the *Custom* palette.
- 7) Click **OK** to save the changes and close the Area dialog. The new color appears as a fill in the selected object and is available for use in other drawings or documents.

Deleting custom colors

Only custom colors that are available in the custom palette can be deleted using the Area dialog. Colors that are available in the color palettes provided by LibreOffice cannot be deleted.

- 1) Select a filled object that uses the color fill for deletion.
- 2) Open the Area dialog using one of the following methods:
 - Go to **Format > Area** on the Menu bar.
 - Right-click on the object and select **Area** from the context menu.
 - Click on **More Options** on the right of the Area section title on the Sidebar.
- 3) Click on **Area**, then click on **Colors** to open the Colors page.

- 4) In **Colors**, select **Custom** from the *Palette* drop-down list.
- 5) Select the color for deletion and click on Delete. There is no confirmation given when deleting a color.
- 6) Click **OK** to save the changes and close the Area dialog.

Gradient fills

Several predefined gradients are included when LibreOffice is installed. It is recommended to create custom gradients that match the requirements rather than modifying the installed predefined gradients. Predefined gradients may have been used in other objects in a drawing or other documents.

Custom gradients are saved with a unique name allowing the custom gradient to be used in other drawings or documents. Custom gradients are placed at the end of the gradients displayed in the *Gradient* box on the **Gradient** page of the Area dialog (Figure 100).

Selecting gradient fills

The following procedure to select a gradient for an area fill uses the Area dialog. Using the tools on the Line and Filling Toolbar, and the *Area* section in the Properties deck on the Sidebar is a similar procedure, but the available options are reduced.

- 1) Make sure the object to be filled is selected in a drawing.
- 2) Open the Area dialog and click on **Area** to open the **Area** page, then click on **Gradient** to open the options available for a gradient fill.

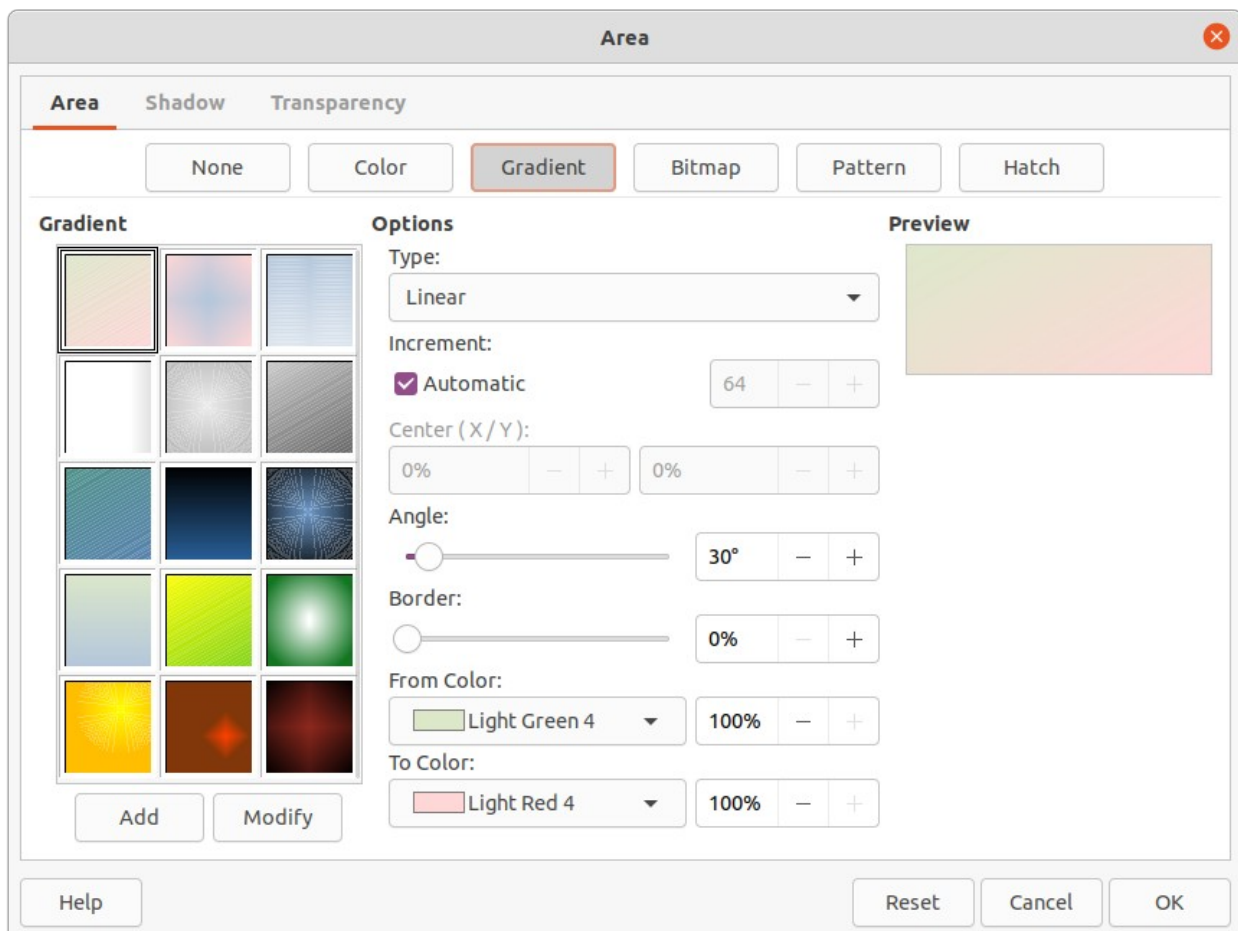

Figure 100: Area dialog – Area Gradient page

- 3) In **Gradient**, select the required gradient from the list of available gradients and the gradient appears in **Preview**.
- 4) To override the default gradient transition of a selection, deselect *Automatic* in **Options** and then enter the values for *Type*, *Increment*, *Center*, *Angle*, *Border*, *From Color* and *To Color* to modify the gradient to the requirements. As changes are made, the gradient displayed in **Preview** also changes to indicate how the gradient will look. For more information on gradient options, see “Table 3: Gradient options” below.
- 5) Click **OK** to close the Area dialog and save the changes. The gradient area fill then appears in the selected object.



Note

Selecting and modifying a gradient using the above method only allows the gradient to be used in the drawing being created. If a modified gradient is to be used in other drawings or documents, then create a custom gradient and save it with a unique name. See “Creating custom gradients” below.

Table 3: Gradient options

Gradient property	Meaning
Linear gradient	The color transitions from the starting color to the end color in a straight line.
Axial gradient	The color transitions from the starting color to the end color from the object center to the object edges in two opposite directions.
Radial gradient	The color transitions from the starting color to the end color in a circular pattern.
Ellipsoid gradient	The color transitions from the starting color to the end color in an elliptical pattern.
Quadratic gradient	The color transitions from the starting color to the end color from the object edges to the object center in four directions.
Square gradient	The color transitions from the starting color to the end color from the object edges to the object center in a square pattern.
Increment	Enter the number of steps for blending the two colors of the gradient. By default this is set to Automatic.
Center X	For Radial, Ellipsoid, Square and Rectangular gradients, modify these values to set the horizontal offset of the gradient center.
Center Y	For Radial, Ellipsoid, Square and Rectangular gradients, modify these values to set the vertical offset of the gradient center.
Angle	For all gradient types, modifies the angle of the gradient axis.
Border	Increase this value to make the gradient start further away from the border of the shape.
From Color	The start color for the gradient. In the edit box enter the intensity of the color: 0% corresponds to black, 100% to the full color.
To Color	The end color for the gradient. In the edit box enter the intensity of the color: 0% corresponds to black, 100% to the full color.

Creating custom gradients

To use a modified gradient in other drawings or documents, a custom gradient has to be saved with a unique name.

- 1) Make sure the object is selected in a drawing.

- 2) Open the Area dialog and click on **Area** to open the **Area** page, then click on **Gradient** to open the options available for a gradient fill.
- 3) Select a gradient and modify it using the options given in “Table 3: Gradient options” above. As changes are made, the gradient displayed in **Preview** also changes to give an indication of how the modified gradient will look.
- 4) Click on **Add** to open a Name dialog.
- 5) Enter a unique name for the new gradient, then click **OK** to close the Name dialog. The custom gradient is placed at the end of the gradients displayed in **Gradient** and becomes available for use in other drawings and documents.
- 6) Click **OK** to close the Area dialog and save the changes.

Modifying custom gradients

Using the **Modify** option on the **Gradient** page in the Area dialog permanently changes a gradient and cannot be undone. It is recommended to only modify custom gradients and not the predefined gradients that were installed with LibreOffice.

- 1) Make sure the object is selected in a drawing.
- 2) Open the Area dialog and click on **Area** to open the **Area** page, then click on **Gradient** to open the options available for a gradient fill.
- 3) Select a custom gradient in **Gradient**. Custom gradients appear below the predefined gradients in **Gradient**.
- 4) Enter the new values for the gradient options that need to be changed. See Table 3 for more information on gradient options. Depending on the type of gradient selected, some options may not be available.
- 5) If necessary and to revert back to the original gradient, click on **Reset** and any changes made are removed.
- 6) Click on **Modify** to permanently change the selected custom gradient. There is no confirmation given when modifying a custom gradient.
- 7) Click **OK** to close the Area dialog and save the changes.

Renaming gradients

- 1) Select the object that uses the gradient that is going to be renamed.
- 2) Open the Area dialog and click on **Area** to open the **Area** page, then click on **Gradient** to open the options available for a gradient fill.
- 3) Right-click on the gradient and select **Rename** from the context menu.
- 4) Enter a name for the gradient in the Name dialog that opens.
- 5) Click **OK** save the change and close the Name dialog.
- 6) Click **OK** to save the changes and close the Area dialog.

Deleting custom gradients

- 1) Select an object that uses a gradient fill.
- 2) Open the Area page on the Area dialog, then click on **Gradient**.
- 3) In the *Gradient* box, select the custom gradient for deletion.
- 4) Right click on the gradient and select **Delete** from the context menu. Click on **Yes** to confirm the deletion.
- 5) Click **OK** to save the changes and close the Area dialog.

✓ Note

It is recommended to only delete or rename custom gradients that have been created. Deleting or renaming one of the predefined gradients that are installed with LibreOffice may cause problems in drawings and documents that use one of the gradients.

Advanced gradient controls

LibreOffice provides advanced controls for gradients on the Transformations toolbar (Figure 101).

- 1) Make sure the object is selected in a drawing.
- 2) Open the **Area** page on the Area dialog, then click on **Gradient**.
- 3) Go to **View > Toolbars > Transformations** on the Menu bar or click on the **Transformations** tool on the Line and Filling toolbar to open the Transformations toolbar.
- 4) Click on **Interactive gradient tool** in the Transformations toolbar. This displays a dashed line connecting two colored squares (Figure 102). The colors show the *From Color* and *To Color* that are used for the selected gradient.
- 5) Select the type of gradient required for the object from the options in the *Type* drop-down list. Properties available for adjustment depend on the gradient type selected, as explained below. Moving the squares has different effects depending on the type of gradient.
 - **Linear** – move the square corresponding to the *From Color* to change where the gradient starts (border value). Move the square corresponding to the *To Color* to change the orientation (angle value).
 - **Axial** – move the *To Color* to change both the angle and border properties of the gradient. Only the square corresponding to the *To Color* can be moved.
 - **Radial** – move the *From Color* to modify the border property to set the width of the gradient circle. Move the *To Color* to change the point where the gradient ends (*Center X* and *Center Y* values).
 - **Ellipsoid** – move the *From Color* to modify the border property to set the size of the gradient ellipsoid. Move the *To Color* to change the angle of the ellipsoid axis and the axis itself.



Figure 101: Transformations toolbar

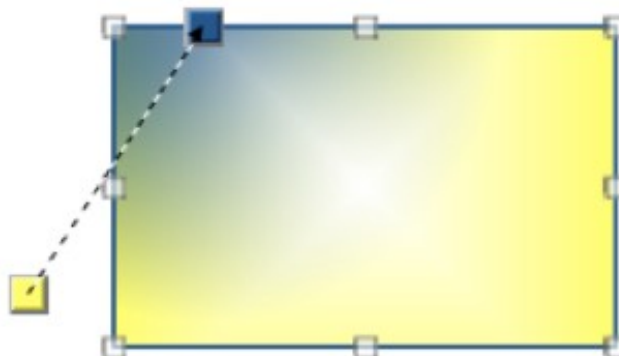

Figure 102: Example of using Interactive Gradient tool

- **Quadratic** – move the *From Color* to modify the border property to set the size of the gradient square or rectangle and the angle of the gradient shape. Move the *To Color* to change the center of the gradient.
- **Square** – move the *From Color* to modify the border property to set the size of the gradient square or rectangle and the angle of the gradient shape. Move the *To Color* to change the center of the gradient.

6) Click **OK** to save the changes and close the Area dialog.

✓ Note

Moving the squares creates different effects depending on the type of gradient. For example, for a linear gradient, the start and end squares of the gradient are always situated either side of the center point of the object.

Bitmap fills

Several predefined bitmaps are included when LibreOffice is installed on a computer. The content of the supplied bitmaps cannot be edited, but the display settings can be changed. Also, bitmaps can be imported from other sources. A GIF is an example of a graphics image file that has a bitmap.

Selecting bitmaps

The following procedure to select a bitmap for an area fill uses the **Bitmap** page of the Area dialog (Figure 103). Using the tools on the Line and Filling Toolbar, and the **Area** panel in the Properties deck on the Sidebar is a similar procedure, but the available options are reduced.

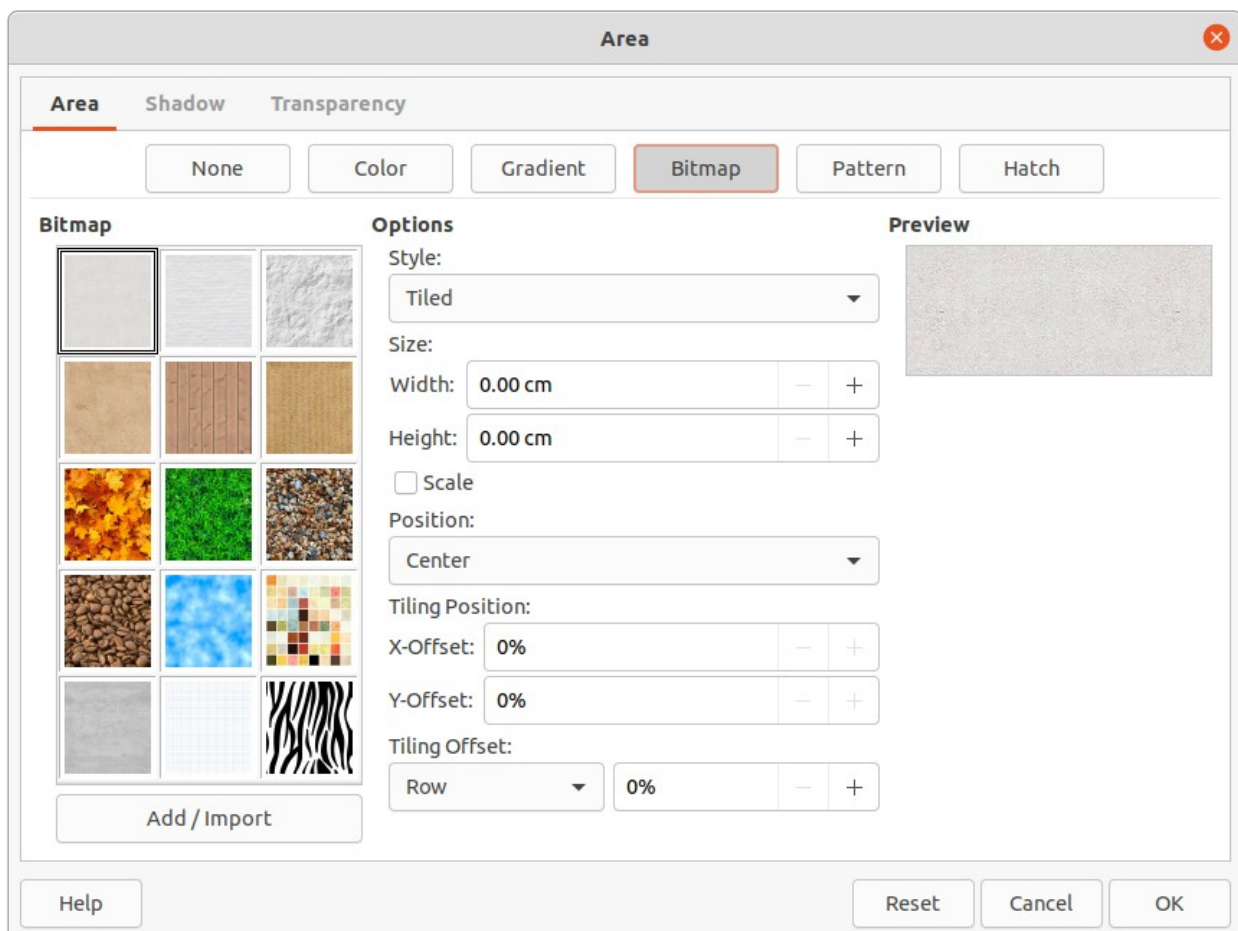

Figure 103: Area dialog – Area Bitmap page

- 1) Make sure the object is selected in a drawing.
- 2) Open the Area dialog and click on **Area** to open the **Area** page, then click on **Bitmap** to open the options available for a bitmap fill (Figure 103).
- 3) In **Bitmap**, select the required bitmap from the list of available bitmaps and it appears in **Preview**. Alternatively, click on **Add/Import** to open a file browser window, then select a file to use as a bitmap fill.
- 4) If necessary, change the values in *Style*, *Size*, *Position*, *Tiling Position*, and *Tiling Offset* to modify the bitmap to the requirements. For more information on bitmap options, see “Table 4” below.
- 5) If necessary and to revert back to the original bitmap, click on **Reset** and any changes made are removed.
- 6) Click **OK** to close the Area dialog and save the changes. The bitmap fill then appears in the selected object.

Table 4: Bitmap options

Bitmap option	Meaning
Style – Custom position/size	When this option is selected, the position of the bitmap in the object and the size of the bitmap can be specified.
Style – Tiled	When this option is selected, the bitmap is tiled to fill the area. The size of the bitmap used for the tiling is determined by the <i>Size</i> settings
Style – Stretched	When this option is selected, a bitmap is stretched to fill the object area.
Size – Width	Sets the width of the bitmap. For example, 100% means that the bitmap is resized to occupy the whole fill area width, 50% means that the width of the bitmap is half that of the fill area.
Size – Height	Sets the height of the bitmap. For example, 100% means that the bitmap is resized to occupy the whole fill area height, 50% means that the height of the bitmap is half that of the fill area.
Size – Scale	When selected, bitmap size is given as a percentage for <i>Width</i> and <i>Height</i> . When deselected, the actual size of the bitmap is given for <i>Width</i> and <i>Height</i> .
Position	Specifies the anchoring point of the bitmap.
Tiling Position – X-Offset	Sets the offset for the width of the bitmap in percentage values. 50% offset means that Draw will place the middle part of the bitmap width at the anchor point and start tiling from there.
Tiling Position – Y-Offset	Sets the offset for the height of the bitmap in percentage values. 50% offset means that Draw will place the middle part of the bitmap height at the anchor point and start tiling from there.
Tiling Offset	Offsets the columns of tiled bitmaps by the percentage entered in the box so that two subsequent columns of bitmaps are not aligned.

Editing bitmaps

- 1) Select an object for editing that contains a bitmap as a fill, or insert a bitmap into a selected object
- 2) Open the Area dialog and click on **Area** to open the **Area** page, then click on **Bitmap** to open the options available for a bitmap fill.
- 3) Select a bitmap from the options available in **Bitmap** to use and edit as a fill. Note that any imported bitmaps are also available. The selected bitmap appears in **Preview**. Note that any imported bitmaps are also available.

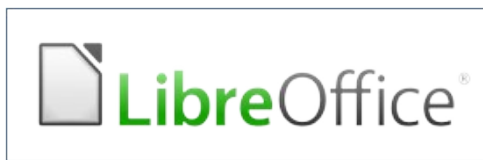

Original bitmap

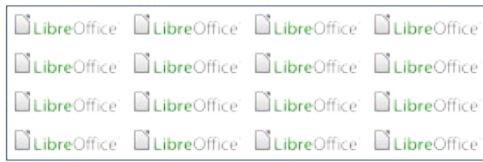

Width and height 25% scaled
Anchor to top left corner
No offset

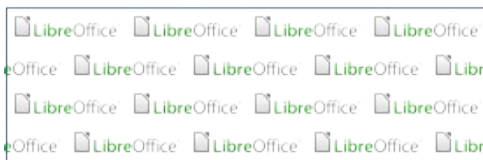

Width and height 25% scaled
Anchor to top right
Row offset 50%

Figure 104: Examples of bitmap fills

- 4) Change the values for *Style*, *Size*, *Position*, *Tiling Position*, and *Tiling Offset* to the requirements. For more information on bitmap options, see “Table 4” above. Examples of bitmap fills and the properties used are shown in Figure 104.
- 5) If necessary and to revert back to the original bitmap, click on **Reset** and any changes made are removed.
- 6) Click **OK** to save the changes and close the Area dialog.



Note

Supplied bitmaps cannot be edited, but the display settings for placement and tiling can be changed.

Importing bitmaps

- 1) Select an object to import a bitmap into the object.
- 2) Open the Area dialog and click on **Area** to open the **Area** page, then click on **Bitmap** to open the options available for a bitmap fill.
- 3) Click on **Add/Import** and a file browser window opens.
- 4) Navigate to the directory containing the bitmap file, then select the file and click **Open**.
- 5) Enter a unique name for the new bitmap in the Name dialog that opens, then click **OK** to close the Name dialog. The imported bitmap appears at the bottom of the bitmaps displayed in **Bitmap**.
- 6) Select the imported bitmap in **Bitmap**.
- 7) Click **OK** to save the changes and close the Area dialog. The imported bitmap fill appears in the selected object.

Renaming bitmaps

- 1) Select an object that uses a bitmap.
- 2) Open the Area dialog and click on **Area** to open the **Area** page, then click on **Bitmap** to open the options available for a bitmap fill.
- 3) Right-click on the bitmap selected for renaming and select **Rename** from the context menu.
- 4) Enter a new name for the bitmap in the Name dialog that opens.
- 5) Click **OK** to save the change and close the Name dialog.

- 6) Click **OK** to save the changes and close the Area dialog.

Note

It is recommended to only rename or delete bitmaps that have been created or imported. Renaming or deleting bitmaps that are installed with LibreOffice may cause problems in documents that use one of these bitmaps.

Deleting bitmaps

- 1) Make sure the object containing a bitmap fill is selected in a drawing.
- 2) Open the **Area** page on the Area dialog, then click on **Bitmap**.
- 3) Right click on the bitmap being deleted and select **Delete** from the context menu. Click on **Yes** to confirm the deletion.
- 4) Click **OK** to save the changes and close the Area dialog.

Pattern fills

Several predefined pattern fills are included when LibreOffice is installed on a computer. Custom patterns can also be created and modified in LibreOffice.

Selecting pattern fills

The following procedure to select a pattern for an area fill uses the Area dialog. Using the tools on the Line and Filling Toolbar, and the **Area** panel in the Properties deck on the Sidebar is a similar procedure, but the available options are reduced.

- 1) Make sure the object is selected in a drawing.
- 2) Open the Area dialog and click on **Area** to open the **Area** page, then click on **Pattern** to open the options available for a pattern fill (Figure 105).
- 3) In **Pattern**, select the required pattern and the selected pattern appears in **Preview**.
- 4) If necessary, change the foreground and background colors, or the pattern itself, as described in “Creating custom patterns” below. As changes are made, the pattern displayed in **Preview** also changes to indicate how the pattern will look. Any changes will affect only the object being filled.
- 5) If necessary and to revert back to the original pattern, click on **Reset** and any changes made are removed.
- 6) Click **OK** to close the Area dialog and save the changes. The pattern fill then appears in the selected object.

Creating custom patterns

- 1) Make sure the object is selected in a drawing.
- 2) Open the Area dialog and click on **Area** to open the **Area** page.
- 3) Select the required pattern in **Pattern** to use as a starting point and the selected pattern appears in **Preview**.
- 4) In **Options**, select a color from the available color palettes for the *Foreground Color* and *Background Color*. The pattern remains the same, but the colors change.
- 5) In *Pattern Editor*, click on individual squares to change the color from *Foreground Color* to *Background Color*, or from *Background Color* to *Foreground Color* to create a new pattern.
- 6) In **Preview**, check the pattern being created to see if the desired effect is being achieved.
- 7) Click on **Add** to open a Name dialog.

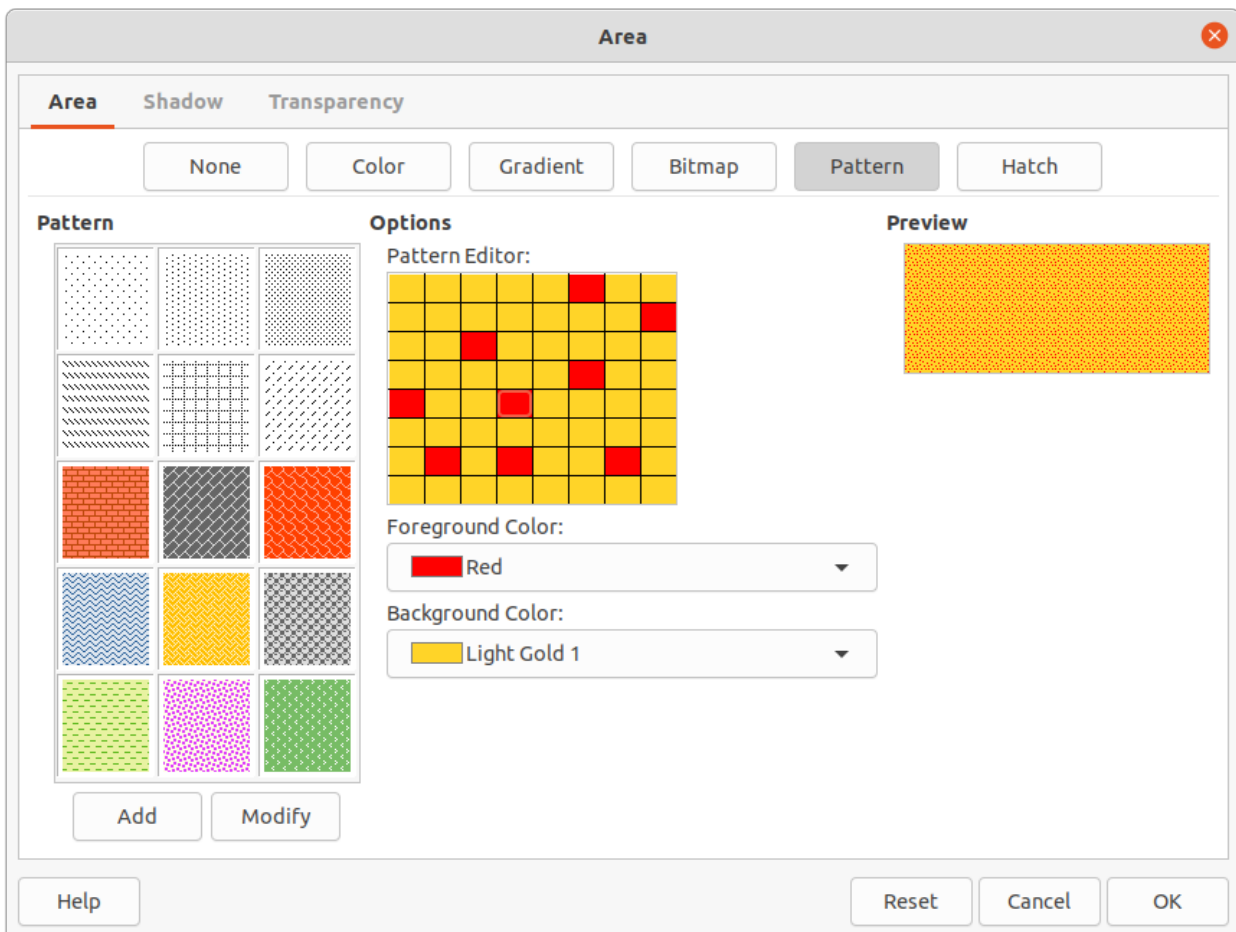

Figure 105: Area dialog – Area Pattern page

- 8) Enter a unique name for the new pattern, then click **OK** to close the Name dialog. The custom pattern is placed at the end of the patterns displayed in **Pattern** and becomes available for use in other drawings and documents.
- 9) If necessary and to revert back to the original pattern, click on **Reset** and any changes made are removed.
- 10) Click **OK** to close the Area dialog and save the changes.

✓ Note

To use a modified pattern in other drawings or documents, the custom pattern has to be saved with a unique name.

Modifying custom patterns

Using the **Modify** option on the **Pattern** page in the Area dialog permanently changes a pattern and cannot be undone. It is recommended to only modify custom patterns and not the predefined patterns that were installed with LibreOffice.

- 1) Make sure the object is selected in a drawing.
- 2) Open the Area dialog and click on **Area** to open the **Area** page, then click on **Pattern**.
- 3) Select a custom pattern from the patterns displayed in **Pattern** and the selected pattern appears in **Preview**. Custom patterns are located below the predefined patterns in the **Pattern**.

- 4) In *Pattern Editor*, click on each square to change the color from *Foreground Color* to *Background Color*, or from *Background Color* to *Foreground Color* to modify the selected pattern.
- 5) If necessary and to revert back to the original pattern, click on **Reset** and any changes made are removed.
- 6) Click on **Modify** to permanently change the selected custom pattern. There is no confirmation given when modifying a custom pattern.
- 7) Click **OK** to close the Area dialog and save the changes.

Renaming patterns

- 1) Select an object that contains a pattern, or insert a pattern into the selected object.
- 2) Open the Area dialog and click on **Area** to open the **Area** page, then click on **Pattern** to open the options available for a pattern fill. The selected pattern appears in *Pattern Editor*.
- 3) Right-click on the pattern for renaming in **Preview** and select **Rename** from the context menu.
- 4) Enter a name for the pattern in the Name dialog that opens.
- 5) Click **OK** to save the renaming and close the Name box.
- 6) Click **OK** to save the changes and close the Area dialog.

Deleting custom patterns

- 1) Select an object that contains a pattern, or insert a pattern into the selected object.
- 2) Open the Area dialog and click on **Area** to open the **Area** page, then click on **Pattern** to open the options available for a pattern fill. The selected pattern appears in *Pattern Editor*.
- 3) Right-click on the pattern for deletion in the **Preview** box and select **Delete** from the context menu.
- 4) Click on **Yes** to confirm the deletion.
- 5) Click **OK** to save the changes and close the Area dialog.

Note

It is recommended to only modify, delete or rename custom patterns that have been created. Deleting or renaming one of the predefined patterns that are installed with LibreOffice may cause problems in drawings and documents that use one of the gradients.

Hatching fills

Hatchings fills are similar to pattern fills, but use lines instead of squares. Several predefined hatching fills are included when LibreOffice is installed on a computer. Custom hatching fills can also be created and modified.

Selecting hatching fills

The following procedure to select a hatching for an area fill uses the Area dialog. Using the tools on the Line and Filling Toolbar, and the **Area** panel in the Properties deck on the Sidebar is a similar procedure, but the available options are reduced.

- 1) Make sure the object is selected in a drawing.

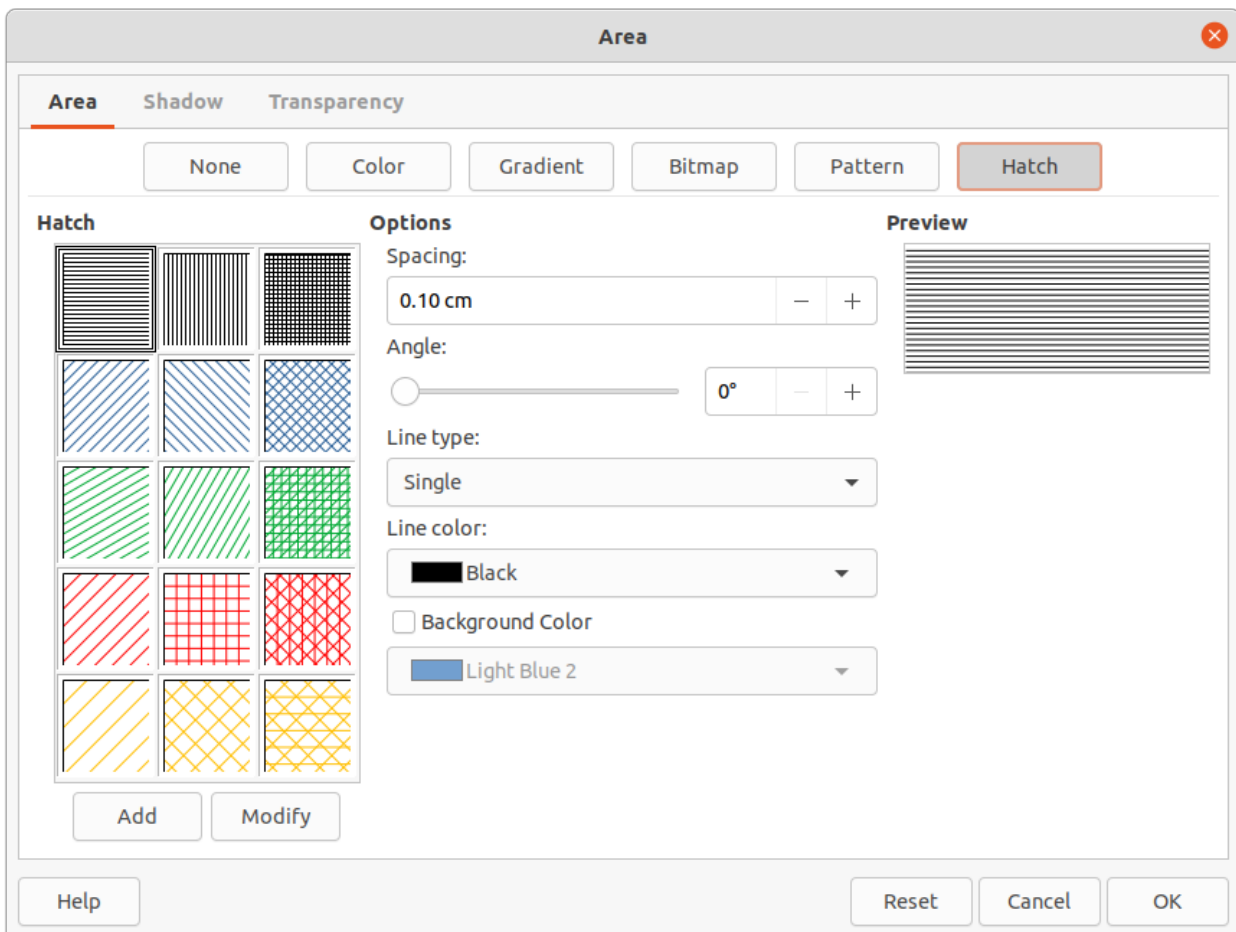

Figure 106: Area dialog – Area Hatch page

- 2) Open the Area dialog and click on **Area** to open the **Area** page, then click on **Hatch** to open the options available for a hatch fill (Figure 106).
- 3) Select a hatch from the options shown in **Hatch** and the selected hatch appears in the **Preview**.
- 4) If necessary, change the colors or other options, as described in “Creating custom hatching” below. As changes are made, the hatching displayed in **Preview** also changes.
- 5) If necessary and to revert back to the original hatching, click on **Reset** and any changes made are removed.
- 6) Click **OK** to close the Area dialog and save the changes. The hatching fill then appears in the selected object.

Creating custom hatching

- 1) Make sure the object is selected in a drawing.
- 2) Open the Area dialog and click on **Area** to open the **Area** page, then click on **Hatch** to open the options available for a hatch fill.
- 3) Select the required hatching in **Hatch** as a starting point and the selected hatching appears in **Preview**.
- 4) Change the values for *Spacing*, *Angle*, *Line type*, *Line color*, and *Background color* to edit the hatching to the requirements. For more information on hatching options, see “Table 5” below.
- 5) Click on **Add** to open a Name dialog.

- 6) Enter a unique name for the new hatching, then click **OK** to close the Name dialog. The custom hatching is placed at the end of the hatchings displayed in **Hatch** and becomes available for use in other drawings and documents.
- 7) Click **OK** to close the Area dialog and save the changes. The new hatch fill appears in the selected object.

Table 5: Hatching options

Hatching option	Meaning
Spacing	Determines the spacing between two lines of the hatching fill. As the value is changed, the preview window is updated.
Angle	Use the mini map below the numerical value to quickly set the angle formed by the line to multiples of 45 degrees. If the required angle is not a multiple of 45 degrees, enter the desired value in the edit box.
Line type	Set single, double, or triple line for the style of the hatching.
Line color	Use the list to select the color of the lines that will form the hatching.
Background color	When selected, adds a color fill behind the lines used for the hatching.

Note

It is recommended to only modify, rename or delete hatch fills that have been created. Modifying, renaming or deleting hatch fills that were installed with LibreOffice may cause problems in documents that use one of these hatch fills.

Modifying custom hatchings

Using the **Modify** option on the **Hatch** page in the Area dialog permanently changes a hatching and cannot be undone. It is recommended to only modify custom hatchings and not the predefined hatchings that were installed with LibreOffice.

- 1) Make sure the object is selected in a drawing.
- 2) Open the Area dialog and click on **Area** to open the **Area** page, then click on **Hatch** to open the options available for a hatch fill.
- 3) Select a custom hatching in **Hatch** and the selected hatching appears in **Preview**. Custom hatchings are located below the predefined hatchings in **Hatch**.
- 4) Change the values for *Spacing*, *Angle*, *Line type*, *Line color*, and *Background color* to edit the hatching. For more information on hatching options, see “Table 5” above.
- 5) If necessary and to revert back to the original hatching, click on **Reset** and any changes made are removed.
- 6) Click on **Modify** to permanently change the selected custom hatching. There is no confirmation given when modifying a custom hatching.
- 7) Click **OK** to close the Area dialog and save the changes.

Renaming hatch fills

- 1) Select the object that contains the hatch fill that is to be renamed.
- 2) Open the Area dialog and click on **Area** to open the **Area** page, then click on **Hatch** to open the options available for a hatch fill.
- 3) Right-click on the hatch fill displayed in **Hatch** and select **Rename** from the context menu.
- 4) Enter a name for the hatch fill in the Name dialog that opens.
- 5) Click **OK** to save the renaming and close the Name dialog.

6) Click **OK** to save the changes and close the Area dialog.

Deleting custom hatching

- 1) Select an object that uses the hatching fill for deletion.
- 2) Open the **Area** page on the Area dialog, then click on **Hatch**.
- 3) In the *Hatch* box, select the custom hatching for deletion.
- 4) Right-click on the hatching and select **Delete** from the context menu. Click on **Yes** to confirm the deletion.
- 5) Click **OK** to save the changes and close the Area dialog.

Working with shadows

Shadows can be applied to objects such as lines, shapes and text. The options available for shadows are as follows:

- **Position** – select one of nine points determining the direction in which the shadow is cast.
- **Distance or Angle** – determines the offset distance between the object and the shadow.
- **Color** – sets the color used for the shadow.
- **Blur** – sets how much the edges of a shadow are blurred or softened.
- **Transparency** – determines the amount of transparency for the shadow: 0% opaque shadow, 100% transparent shadow.

Default shadows

To quickly apply a shadow to an object, select the object and click on **Shadow** in the Line and Filling toolbar. The shadow applied to an object using this method is set to the default settings in LibreOffice.

Note

For more control when applying shadows, use the **Shadow** page in Area or Line dialogs. The following information describes the use of the **Shadow** page in the Area dialog (Figure 107), but can also be applied to the **Shadow** page in the Line dialog.



Figure 107: Area dialog - Shadow page

Formatting shadows

For a more control when adding shadows to an object, use the **Shadow** page on the Area dialog as follows:

- 1) Select an object where a shadow is going to be applied.
- 2) Open the Area dialog and click on **Shadow** to open the **Shadow** page.
- 3) Select *Use shadow* in **Properties** and the shadow options become active.
- 4) Select from one of nine points the direction in which the shadow is going to be cast in relation to the object.
- 5) In *Color*, select the color palette from the drop-down list of available palettes and then select the color required for the shadow.
- 6) In *Distance*, enter a distance to set spacing between the object and the shadow.
- 7) In *Blur*, enter a value to soften the edges of the shadow.
- 8) In *Transparency*, enter a percentage for the shadow transparency.
- 9) Click **OK** to close the Area dialog and save the changes.

Sidebar shadow formatting

- 1) Select an object where a shadow is going to be applied.
- 2) Click on **Properties** to open the Properties deck on the Sidebar.
- 3) Click on **Shadow** to open the **Shadow** panel (Figure 108) in the Properties deck.
- 4) Select *Enable* and the shadow options become active.
- 5) In *Angle*, select from one of the options available from the drop-down list to set the direction of where the shadow is going to be cast in relation to the object.

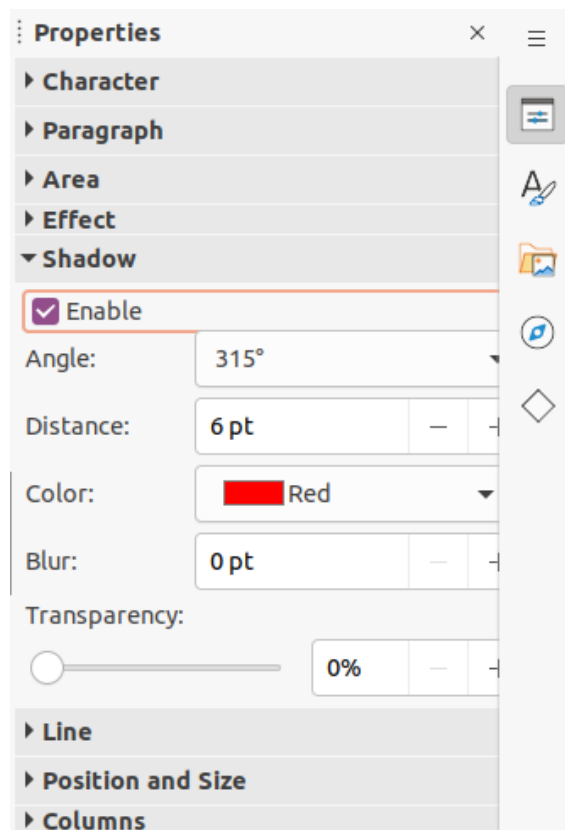

Figure 108: Shadow panel in Properties on sidebar

- 6) In *Color*, select the color palette from the drop-down list of available palettes and then select the color required for the shadow.
- 7) In *Distance*, enter a distance to set spacing between the object and the shadow.
- 8) In *Blur*, enter a value to soften the edges of the shadow.
- 9) In *Transparency*, move the slider or enter a percentage in the text box to set the shadow transparency.
- 10) Deselect the object to save the changes made.

Working with transparencies

Transparencies can be applied to objects and to any shadow that has been applied to an object. In Draw two types of transparencies can be applied to an object – uniform transparency and gradient transparency. For more information on gradient transparencies, including an example of combining a color gradient with a gradient transparency, see “Gradient fills” on page 84.

Transparencies can be applied to area fills as well as shadows and lines.

- To use transparencies on lines, refer to “Formatting lines” on page 70 for more information.
- To use transparencies on shadows, refer to “Working with shadows” on page 96 for more information.

The following procedure applies a transparency to an object area fill using the Area dialog (Figure 109):

- 1) Make sure the object is selected in a drawing.
- 2) Open the Area dialog, then click on **Transparency** to the open the **Transparency** page and access the available options.
- 3) To create a uniform transparency, select *Transparency* and enter a percentage in the text box.

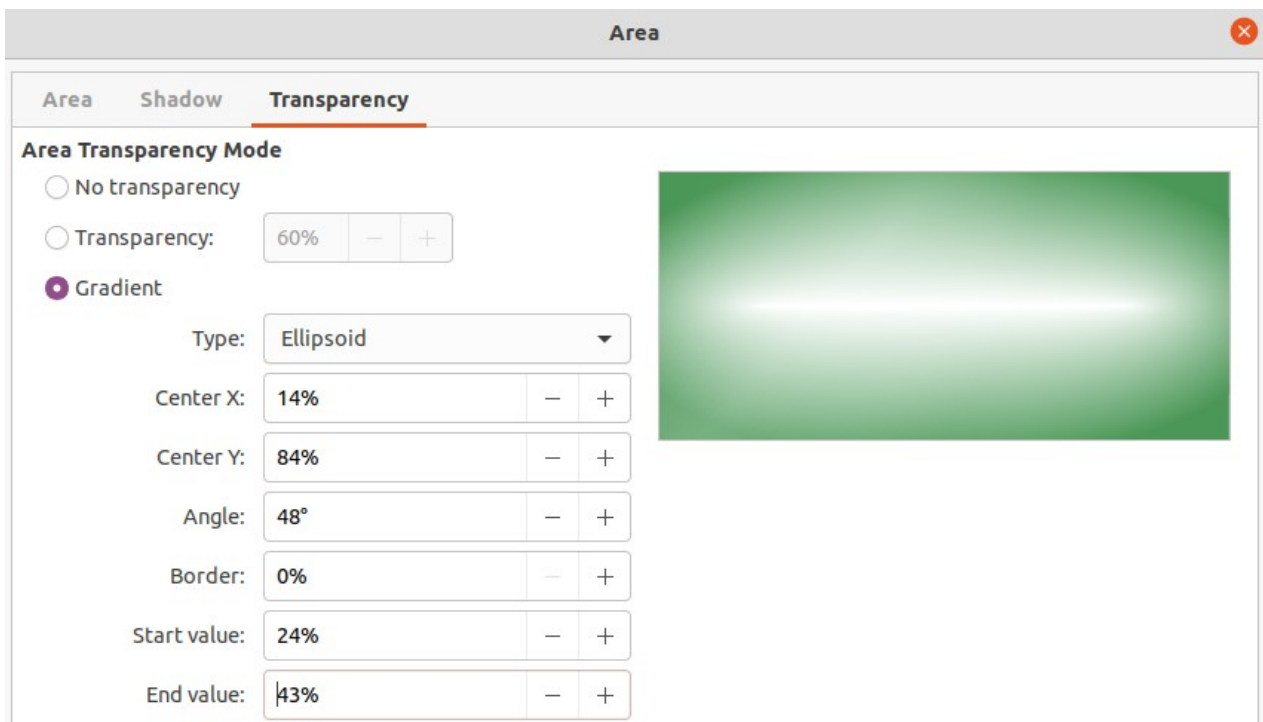

Figure 109: Area dialog - Transparency page

- 4) To create a gradient transparency so that the area becomes gradually transparent, select *Gradient* and select the type of gradient transparency from the drop-down list: *Linear*, *Axial*, *Radial*, *Ellipsoid*, *Quadratic* or *Square*. See “Table 3” on page 85 for more information on gradient types.
- 5) Set the parameters for the type of the gradient transparency selected above. Refer to “Table 6” below for a description of the properties. The parameters available depends on the type of gradient transparency selected above.
- 6) Click **OK** to close the Area dialog and save the changes.

Table 6: Transparency parameters

Transparency parameters	Meaning
Centre X	For <i>Radial</i> , <i>Ellipsoid</i> , <i>Quadratic</i> and <i>Square</i> gradients. The values to set the horizontal offset of the gradient center.
Center Y	For <i>Radial</i> , <i>Ellipsoid</i> , <i>Quadratic</i> and <i>Square</i> gradients. The values to set the vertical offset of the gradient center.
Angle	For <i>Linear</i> , <i>Axial</i> , <i>Ellipsoid</i> , <i>Quadratic</i> and <i>Square</i> gradients. Specifies the angle of the gradient axis.
Border	Increase this value to make the gradient start further away from the border of the object.
Start value	Value for the starting transparency gradient. 0% is fully opaque, 100% means fully transparent.
End value	Value for the ending transparency gradient. 0% is fully opaque, 100% means fully transparent.

Drawing styles

Suppose that the same area fill, line thickness, and border is to be applied to a set of objects. This repetitive process can be greatly simplified by the use of styles. Styles allow a format to be defined and then applied to multiple objects. For more information on styles, see the *Writer Guide*.

Note

The drawing styles included with LibreOffice Draw cannot be deleted or renamed. However, all drawing styles can be modified to the drawing requirements. Also, drawing styles can be hidden when not required, except for any drawing styles that have been used in a drawing.

Style categories

- **All Styles** – displays all the drawing styles available for use in Draw.
- **Applied Styles** – displays the drawing styles that have been used in the selected drawing.
- **Hierarchical Styles** – displays the drawing styles in a hierarchical list (also known as a linked or parent/child styles). To view the styles in a sub-level, click on the triangle ► next to the style name to list the styles available in the sub-level, as shown in Figure 110.
- **Custom Styles** – displays all the user created drawing styles that are available for use in Draw.
- **Hidden Styles** – displays all the drawing styles that a user has hidden when not required for use in Draw.

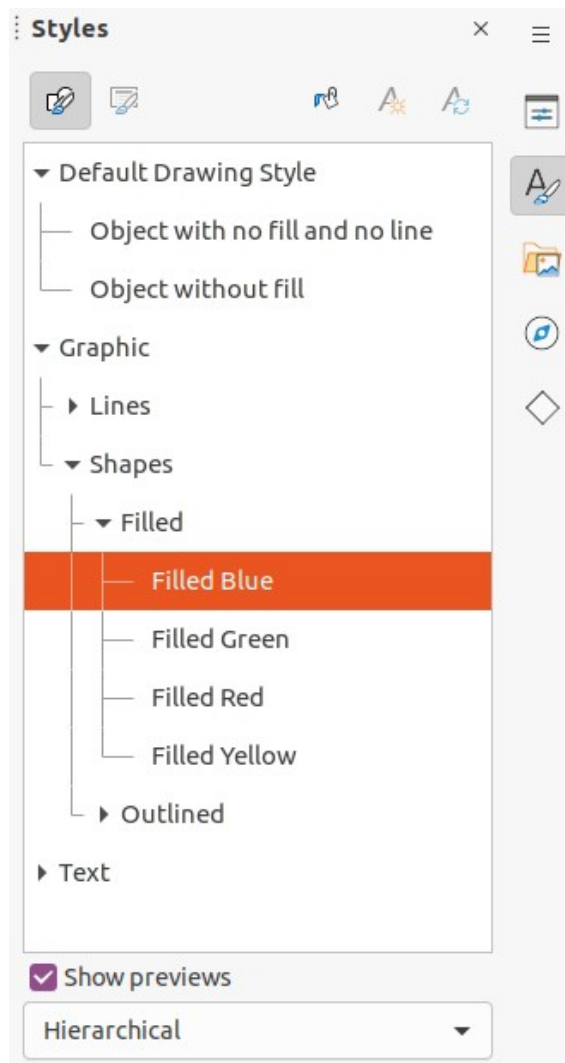

Figure 110: Styles deck on Sidebar

✓ Note

Hierarchical styles are used with multiple objects differ, for example, in color, but are otherwise identically formatted. Create a parent style for the objects including borders, area fill, font, and so on. Then create a hierarchical or child styles, which differ only in the fill color attribute. If the font size or the thickness of a border needs to be changed, it is sufficient to change the parent style and all the child styles are changed accordingly.

i Tip

At the bottom of the Styles deck on the Sidebar there is a drop-down list allowing selection of the style category. The style categories available are *Hierarchical*, *All Styles*, *Hidden Styles*, *Applied Styles*, and *Custom Styles*.

✓ Note

When an object is placed into a drawing, the **Default Drawing Style** is automatically applied.

Selecting styles

Styles can only be selected and applied to objects using the Styles deck on the Sidebar (Figure 110).

- 1) Select the object for style application.
- 2) Open the Styles deck on the Sidebar using one of the following methods:
 - Go to **View > Sidebar** on the Menu bar, then click on **Styles** at the right side of the Sidebar.
 - Click on **Show the Styles Sidebar** on the Line and Filling toolbar.
 - Go to **View > Styles** on the Menu bar.
 - Use the keyboard shortcut *F11*.
- 3) Select a style category from the drop-down list at the bottom of the Styles deck.
- 4) In the Styles deck, double-click on the style required for the selected object.
- 5) If necessary, create a new (custom) style or modify the selected style to the requirements, as described below.

Note

It is recommended to create new (custom) styles rather than modify the drawing styles installed with LibreOffice. Modifying drawing styles installed with LibreOffice may cause problems if the style has been used in other drawings.

Creating new or custom styles

After creating a new or custom style, it is placed in **All Styles** and **Custom Styles** categories in the Styles deck of the Sidebar. When the custom style is applied to an object, the custom style also appears in **Applied Styles**.

Using Styles deck

- 1) Open the Styles deck on the Sidebar.
- 2) Right click on the style required as a starting point to create a custom style and select **New** from the context menu to open the Graphic Styles dialog (Figure 111).
- 3) Click on the **Organizer** tab to open the **Organizer** page in the Graphic Styles dialog.
- 4) In the *Name* text box, enter a unique style name.
- 5) In *Inherit from* text box, select **None** from the drop-down list if the new drawing style is NOT going to be linked. When the object was created, it was allocated the Default Drawing Style and this new drawing style linked by default to the Default Drawing Style.
- 6) If the new style is to inherit settings from an existing style, select a style from the *Inherit from:* drop-down list.
- 7) Use the options on the various pages of the Graphic Styles dialog to format and categorize a new style.
 - **Organizer** – contains a summary of the style and its hierarchical position.
 - **Font, Font Effects, Indents & Spacing, Alignment, and Tabs** – sets the attributes of the text inserted into a text box or graphic object.
 - **Dimensioning** – sets the style of dimension lines when used on an object.
 - **Text, Text Animation, Connector, Line, Area, Shadowing, Highlighting and Transparency** – sets the attributes for the object format.
- 8) Click **OK** when finished to save the new style and close the Graphic Styles dialog.

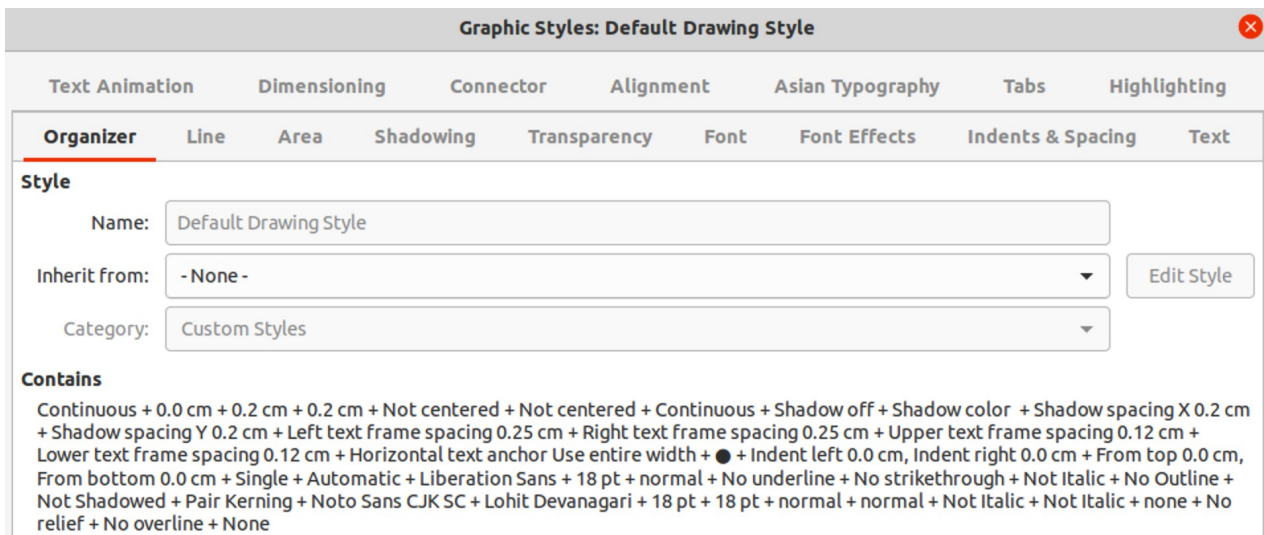

Figure 111: Graphic Styles dialog - Organizer page

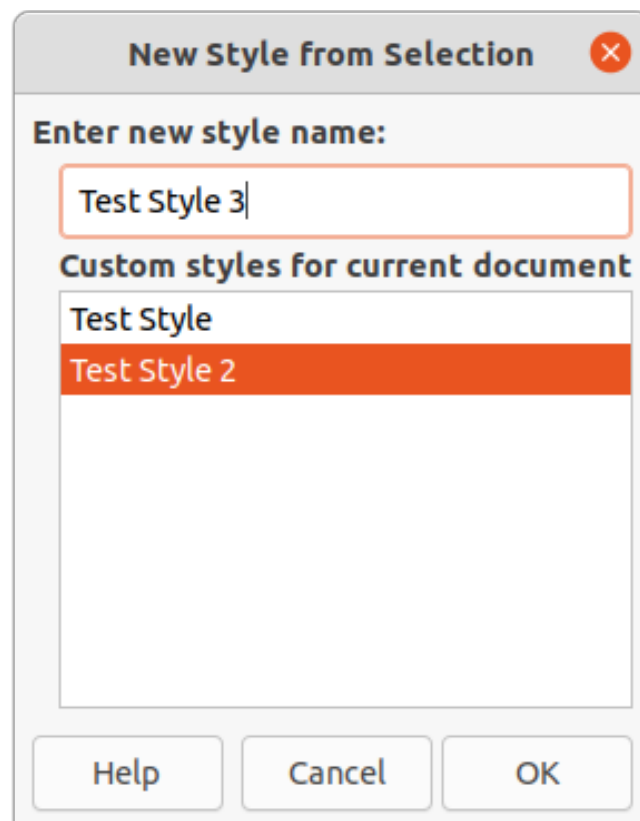

Figure 112: New style from Selection dialog

Note

Any new drawing style created is automatically placed in the **Custom Styles** category.

Using New Style from Selection

Using **New Style from Selection** allows all formatting to be made to an object first and then create a drawing style from that object.

- 1) Select an object to create a new style from, or create a new object in a drawing.

- 2) Format the object using the tools and options from the Graphic Styles dialog, Area dialog, Line dialog, Properties deck on the Sidebar, or Line and Filling toolbar.
- 3) Create the new style using one of the following methods:
 - Open the Styles deck on the Sidebar and click on **New Style from Selection** at the top right of the deck.
 - Go to **Format > Styles > New Style from Selection** on the Menu bar.
- 4) In the New Style from Selection dialog (Figure 112), type a unique name for the new style. This dialog also shows existing custom styles.
- 5) Click **OK** to save the new style and close the New Style from Selection dialog.

Modifying styles

It is recommended to only modify custom styles that have been created. Modifying styles that are installed with LibreOffice may cause problems in other documents that use one of these styles.

- 1) Select an object in a drawing.
- 2) Click on **Styles** on the left of the Sidebar to open the **Styles** deck.
- 3) Open the Graphic Styles dialog using one of the following methods:
 - Go to **Format > Styles > Edit Style** on the Menu bar.
 - Right-click on the object and select **Edit Style** from the context menu.
 - Right-click on the style that is highlighted in the Styles deck on the Sidebar and select **Modify** from the context menu.
- 4) Use the options on the various pages of the Graphic Styles dialog to modify the style.
- 5) Click **OK** to save the changes and close the Graphic Styles dialog.

Editing hierarchical or parent styles

If an object in a drawing uses a style that is linked to a hierarchical or parent style, then it is possible to edit the hierarchical or parent style.

- 1) Select an object in a drawing that uses a linked style.
- 2) Open the Graphic Styles dialog and click on **Organizer** to open the **Organizer** page in the Graphic Styles dialog.
- 3) Check that the style name in the *Inherit from* text box is the hierarchical or parent style for editing, then use the options on the various pages in the Graphic Styles dialog to edit the style.
- 4) If the hierarchical or parent style is NOT the one required:
 - a) Click on **Edit Style** to the right of the *Inherit from* text box until the name of the style is displayed.
 - b) Use the options on the various pages in the Graphic Styles dialog to edit the style.
- 5) Click **OK** to save the changes and close the Graphic Styles dialog.

Note

It is recommended to create custom hierarchical styles rather than modify the existing hierarchical styles available in LibreOffice. Modifying hierarchical styles installed with LibreOffice may cause problems if the style has been used in other drawings.

Updating styles

Using **Update Style** allows all the formatting to an object to be made first and then update the drawing style used by the object.

- 1) Select the object to modify the drawing style the object uses.
- 2) Format the object using the tools and options from the Graphic Styles dialog, Area dialog, Line dialog, Properties deck on the Sidebar, or Line and Filling toolbar.
- 3) Update the drawing style using one of the following methods. There is no confirmation when updating a drawing style.
 - Open the Styles deck on the Sidebar and click on **Update Style** at the top right.
 - Go to **Format > Styles > Update Selected Style** on the Menu bar

Note

Make sure to only update custom styles that have been created. Updating styles that are part of the default installation of LibreOffice could cause problems in other documents that use LibreOffice drawing styles.

Applying styles

Drawing styles are applied to an object using the Styles deck on the Sidebar as follows:

- 1) Select the object to apply a drawing style.
- 2) Click on **Styles** on the Line and Filling toolbar, or click on **Styles** on the Sidebar.
- 3) Double click on the style name to apply the drawing style to the selected object.

Deleting styles

Predefined styles in LibreOffice cannot be deleted, even if they are not being used. Only custom styles can be deleted. However, before deleting a custom style, it is recommended to make sure the drawing style is not in use by checking the list of drawing styles in the *Applied Styles* category.

- 1) To open a list of styles, use one of the following methods:
 - Click on **Styles** on the Line and Filling toolbar.
 - Click on **Styles** on the Sidebar.
- 2) Select *Applied Styles* from the drop-down list at the bottom of the Styles deck on the Sidebar.
- 3) Right click on the style name in the styles list and select **Delete** from the context menu.
- 4) If the style is used on an object, a warning message will appear stating that the selected object will revert back to the default drawing style. Select **Yes** to confirm deletion of the style.
- 5) If the style is not in use, select **Yes** to confirm deletion of the style and there is no confirmation message.

Special effects

As well as the basic actions of moving and resizing an object, a number of special effects can also be applied to objects in Draw. Several of these effects are readily available in the Transformations toolbar. If the Transformations toolbar (Figure 101 on page 87) is not showing, select it from **View > Toolbars > Transformations** on the Menu bar.

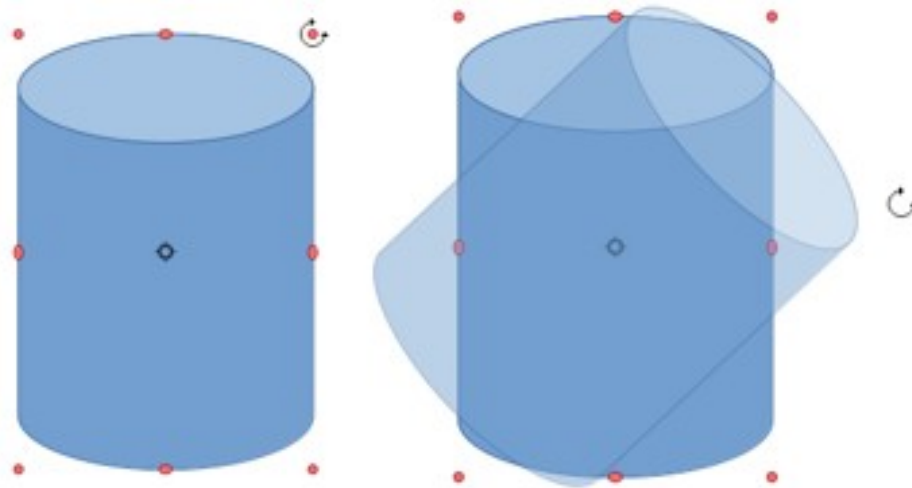

Figure 113: Manually rotating objects

The tools on the Transformations toolbar are described in the following sections with the exception of the **In 3-D Rotation Object** tool, which is described in Chapter 7, Working with 3D Objects.

Rotating objects

Manual rotation

- 1) Select the object for rotation so that the selection handles are displayed.
- 2) Use one of the following methods to switch the selected object into rotation mode,. The selection handles change shape and color when in rotation mode (Figure 113).
 - Click again on the selected object.
 - Click on the triangle ▼ to the right of **Transformations** on the Line and Filling and select **Rotate** from the context menu.
 - If the Transformations toolbar is displayed, click on **Rotate**.
- 3) Move the cursor over one of the corner handles and the cursor changes shape.
- 4) Click and drag the object in the rotation direction. Only the corner selection handles are active for rotation.
- 5) To restrict the rotation angles to multiples of 15 degrees, press and hold the *Shift* key while rotating the object. This is very handy for rotating objects through 90 deg, for example from portrait to landscape.
- 6) When satisfied with the rotation, release the mouse button.
- 7) By default, the rotation pivot point is a small circle in the center of the selected object. To change the center of object rotation, click and drag the rotation pivot point to a new position. This position for the rotation pivot point can be outside of the selected object.

Sidebar rotation

- 1) Select the object for rotation so that the selection handles are displayed.
- 2) Open the **Position and Size** panel in the Properties deck on the Sidebar (Figure 114).
- 3) Rotate the object using one of the following options:
 - Click on and drag the *Rotation Angle* indicator in *Rotation*.
 - Enter a rotation angle in the *Select the angle for rotation* text box.
- 4) When satisfied, click outside the object to deselect the object and deselect rotation mode.

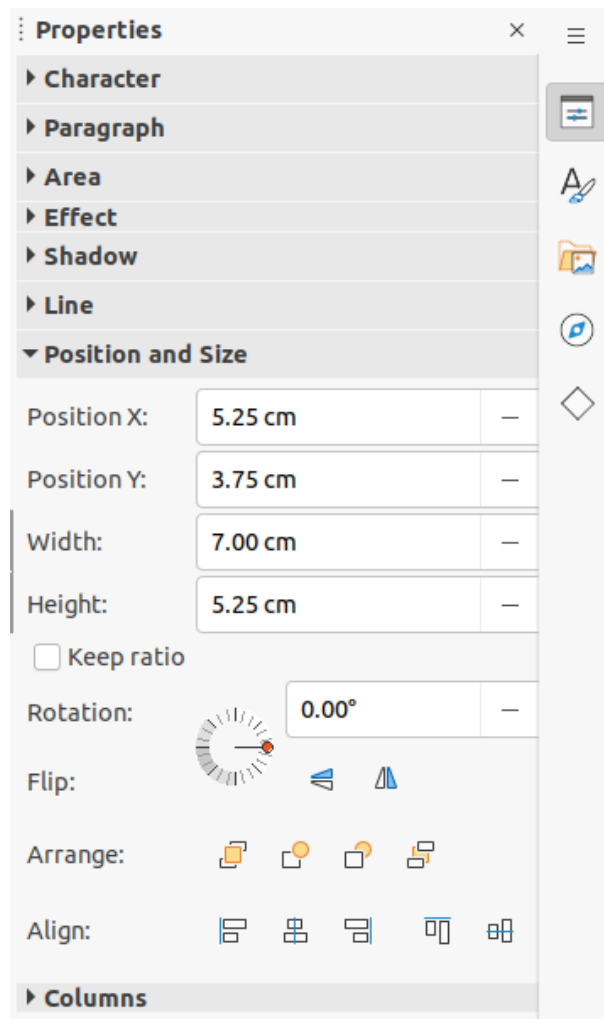

Figure 114: Position and Size panel in Properties deck on Sidebar

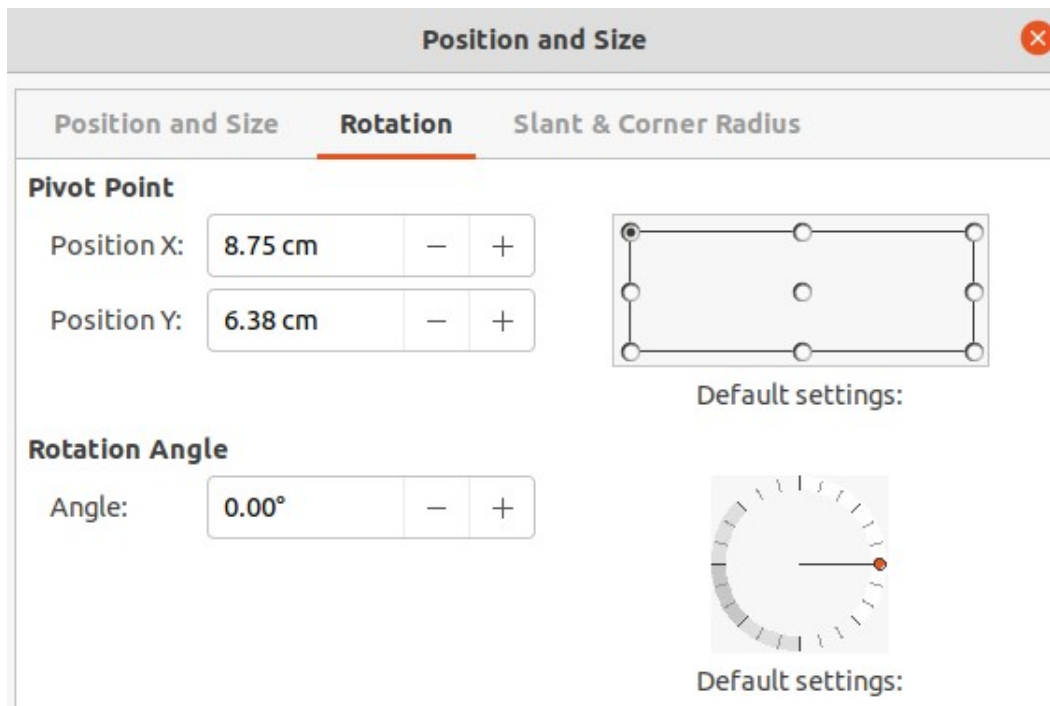

Figure 115: Position and Size dialog - Rotation page

Position and Size dialog

- 1) Select the object for rotation so that the selection handles are displayed.
- 2) Open the Position and Size dialog (Figure 115) using one of the following methods:
 - Use the keyboard shortcut *F4*.
 - Select **Format > Position and Size** on the Menu bar.
 - Right-click on the object and select **Position and Size** from the context menu.
- 3) Click **Rotation** to open the **Rotation** page.
- 4) If required, in **Pivot Point** enter a value for *Position X* and *Position Y* to move the position of the pivot point. The default position of the pivot point is the center of the object. Alternatively, select a pivot point from one of the 9 positions in *Default settings*.
- 5) In **Rotation Angle**, rotate the object using one of the following methods:
 - In the *Angle* text box, enter the degrees of rotation required.
 - Click on and drag the rotation indicator in *Default settings*.
- 6) Click **OK** to save the changes and close the Position and Size dialog.

Flipping objects

Quick flipping

- 1) Select the object for flipping so that the selection handles are displayed.
- 2) Use one of the following methods to flip the object vertically or horizontally:
 - Right click on the object and select **Flip > Horizontally** or **Flip > Vertically** from the context menu.
 - In the *Position and Size* section of the Properties deck on the Sidebar, click on **Flip Vertically** or **Flip Horizontally**.
 - In the Line and Filling toolbar, click on **Vertically** or **Horizontally**.
 - Go to **Shape > Flip > Vertically** or **Horizontally** on the Menu bar.

Flip tool

Using the Flip tool on the Transformations toolbar (Figure 101 on page 87), the position and angle that the object flips over can be changed, as shown in Figure 116.

- 1) Select the object for flipping so that the selection handles are displayed.
- 2) Click on **Flip** on the Transformations toolbar and the symmetry axis appears as a dashed line through the middle of the object. The object will be flipped about this symmetry axis.

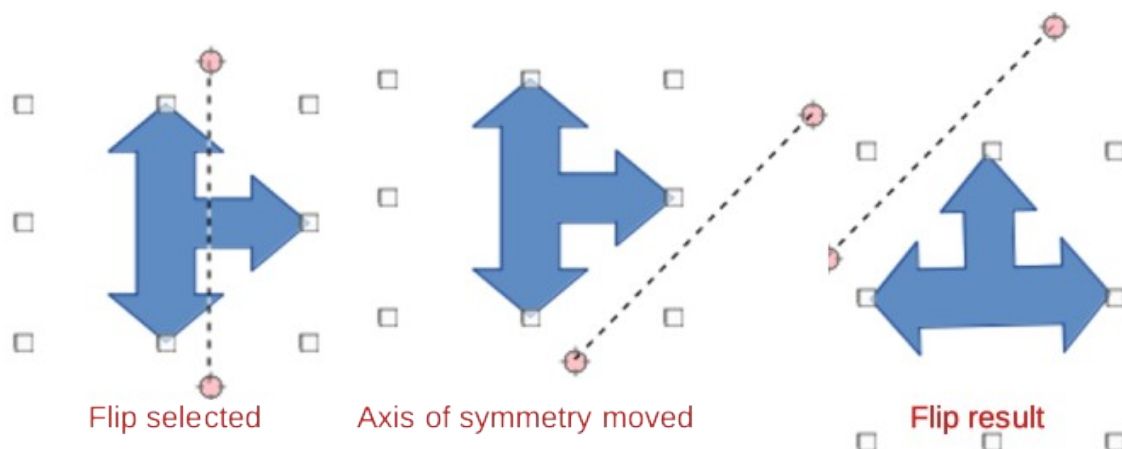

Figure 116: Example of using Flip tool

- 3) Click and drag one or both ends of the symmetry axis to set the orientation of the axis.
- 4) Place the cursor over one of the object selection handles until it changes shape.
- 5) Click and drag the object across to the other side of the symmetry axis until the object appears flipped over. The angle and position of the flip depends on the angle and position of the symmetry axis.
- 6) Release the mouse button and the object is flipped.

✓ Note

Pressing and holding the *Shift* key while moving the symmetry axis allows rotation in 45 degree increments.

Mirror copies

At the moment there is no mirror command existing in Draw. However, mirroring an object can be emulated by copying and flipping the object as follows:

- 1) Select the object to make a mirror copy of and copy the object to the clipboard.
- 2) Flip the object using the procedures in “Flipping objects” above.
- 3) Click in an empty area on the drawing to deselect the object.
- 4) Paste the copy of the original object back into its original location, creating a mirror copy.
- 5) If necessary, select both objects and align them using one of the following methods:
 - Go to **Shape > Align** on the Menu bar and use one of the alignment options.
 - Right-click the selected objects and select **Align** from the context menu, then select one of the alignment options.

Distorting images

Three tools on the Transformations toolbar allow an object to be distorted.

- **Distort** – distorts an object in perspective.
- **Set to circle (slant)** and **Set in Circle (perspective)** – both create a pseudo 3D effect.

Before distorting an object, the object must be converted to a circle. Clicking on and dragging one of the object handles produces the desired effect. Examples of distortion are shown in the following figures.

✓ Note

Transforming an object into a curve is a safe operation, but cannot be reversed other than by clicking **Format > Undo** on the Menu bar.

Set in circle (perspective)

An example of distorting an object with the **Set in Circle (perspective)** tool is shown in Figure 117.

- 1) Select an object and click on the **Set in Circle (perspective)** in the Transformations toolbar.
- 2) Click **Yes** to convert the object to a curve. If the object is already a curve, this dialog does not appear.
- 3) Click and drag one of the selection handles to give a pseudo 3D perspective using the opposite side as an anchor point. A ghosted image appears as the object is distorted to give an indication of how the resulting object will look.

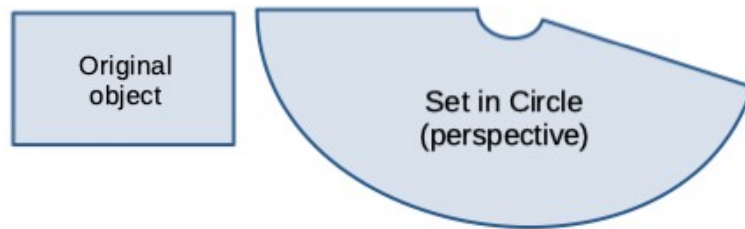

Figure 117: Example of using Set in Circle (perspective) distortion



Figure 118: Example of using Set to Circle (slant) distortion

Set to circle (slant)

An example of distorting an object with the **Set to circle (slant)** tool is shown in Figure 118.

- 1) Select an object and click on the **Set to circle (slant)** in the Transformations toolbar.
- 2) Click **Yes** to convert the object to a curve. If the object is already a curve, this dialog does not appear.
- 3) Click and drag one of the selection handles to give a pseudo 3D perspective using the opposite side as an anchor point. A ghosted image appears as the object is distorted to give an indication of how the resulting object will look.

Distort

Examples of distorting an object with the **Distort** tool are shown in Figure 119.

- 1) Select an object and click on **Distort** on the Transformations toolbar.
- 2) Click **Yes** to convert the object to a curve. If the object is already a curve, this dialog does not appear.
- 3) Click and drag a corner selection handle to distort the object using the opposite corner selection handle as an anchor point for the distortion.
- 4) Click and drag the vertical selection handles to distort the object using the opposite vertical side as an anchor point for the distortion.
- 5) Click and drag the horizontal selection handles to distort the object using the opposite horizontal side as an anchor point for the distortion.

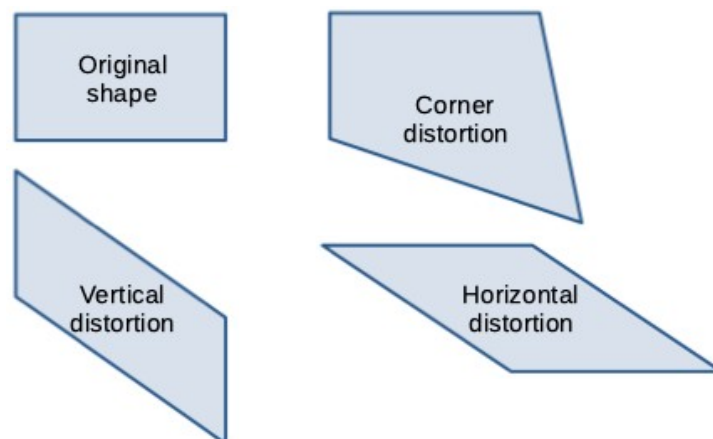

Figure 119: Examples of object distortion

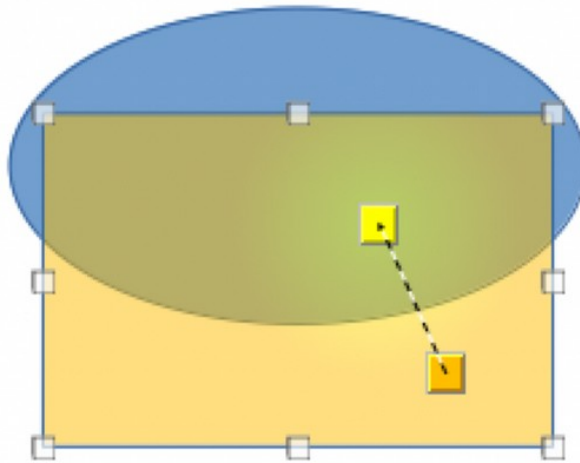

Figure 120: Example of dynamic gradient

Dynamic gradients

Transparency gradients are controlled in the same manner as color gradients and both types of gradient can be used together. With a transparency gradient, the direction and degree of object fill color changes from opaque to transparent. In a color gradient, the fill changes from one color to another, but the degree of transparency remains the same.

Two icons on the Transformations toolbar dynamically control transparency and color gradients. Even if an object with a color fill is not assigned transparency, the transparency can be controlled by clicking on **Interactive transparency tool**. This defines a transparency gradient and a dashed line connecting two squares appears on the object. Move the two squares to modify the gradient. Define the direction of the gradient (vertical, horizontal, or at any angle) and the spot at which the transparency begins.

A regular color gradient is defined in the same manner. Select an object, then select a gradient area fill (see “Gradient fills” on page 84 for more information). The **Interactive gradient tool** is now active on the Transformations toolbar. When clicking on **Interactive gradient tool**, a dashed line connecting two squares appears on the object, just as it does for a transparency gradient.

In both transparency gradient and gradient fill, click outside the object to set the gradient.

In the example shown in Figure 120 there is a single color object and a transparency gradient, covering part of the underlying object. This gradient transparency can be dynamically adjusted. Direction of transparency is changed by moving the white square and the distance over which it is applied by moving the green square.

✓ Note

Moving the squares has different effects, depending on the type of gradient. For example, for a linear gradient, the start and end squares of the gradient will always be situated to either side of the center point of the object.



LibreOffice
Community



Draw Guide 7.2

Chapter 5, Combining Multiple Objects

Grouping objects

Grouping of objects is similar to putting objects into a container. Objects within a group are moved together as one object and any changes made are applied globally to the objects within the group. A group can always be undone and the objects that make up the group can always be manipulated separately.

Temporary grouping

A temporary grouping is when several objects are selected. Any changes to object parameters are applied to all of the objects within the temporary group. For example, a temporary group of objects can be rotated in its entirety.

A temporary group is created using one of the following methods:

- Click and drag the cursor over several objects surrounding the objects with a selection rectangle (this selection rectangle is also known as a marquee). Release the mouse button when all the objects required for a temporary group are selected.
- Click the first object, then hold down the *Shift* key and click on the remaining objects for the temporary group.

To cancel a temporary group of objects, simply click outside of the selection handles displayed around the objects.

Grouping

When objects are grouped, any editing operations carried out on the group are applied to all objects within the group. Click on one object in a group, and the whole group is selected.

The objects within a group retain their own individual properties and can be edited independently. See “Editing individual group objects” on page 113 for more information.

- 1) Select the objects for a group using one of the following methods. Selection handles appear around all the objects selected for the group (Figure 121).
 - Click on each object in turn while holding down the *Shift* key.
 - Make sure **Select** on the Drawing toolbar is selected and draw a selection rectangle around the objects required for the group using the cursor.
 - To select all the objects in a drawing, go to **Edit > Select All** on the Menu bar or use the keyboard shortcut *Ctrl+A*.
- 2) Create the group of selected objects using one of the following methods:
 - Right-click on an object within the selected group and select **Group** from the context menu.
 - Go to **Shape > Group > Group** on the Menu bar.
 - Use the keyboard shortcut *Ctrl+Shift+G*.

Ungrouping

- 1) Select the group of objects and selection handles appear around the objects within the group (Figure 121).
- 2) Ungroup the group of objects using one of the following methods:
 - Right-click on the selected group and select **Ungroup** from the context menu.
 - Go to **Shape > Group > Ungroup** on the Menu bar.
 - Use the keyboard shortcut *Ctrl+Alt+Shift+G*.

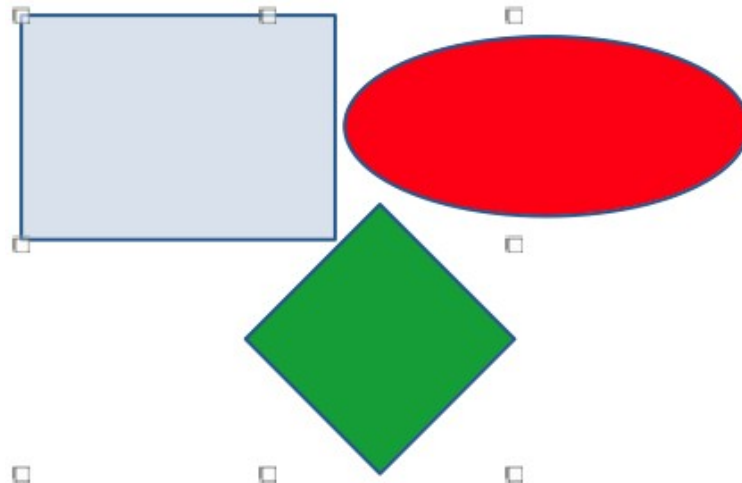

Figure 121: Example of grouping objects

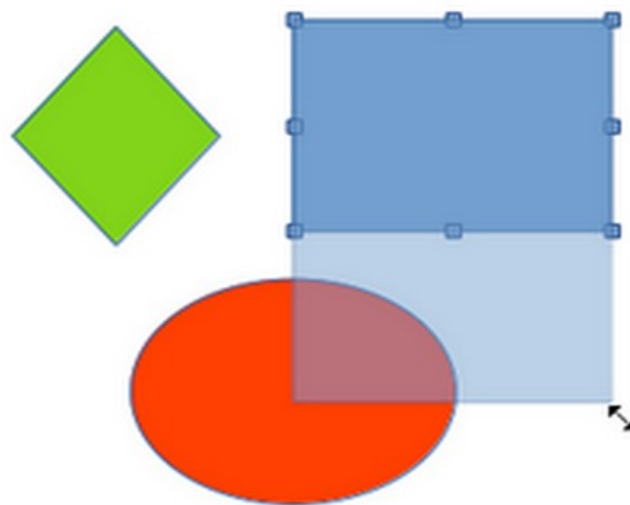

Figure 122: Example of editing objects within a group

Editing individual group objects

An object within a group can be edited individually without ungrouping the objects.

- 1) Select a group, then enter the group using one of the following methods. After entering a group, objects outside the group cannot be selected for editing.
 - Right-click on the group and select **Enter Group** from the context menu.
 - Go to **Shape > Group > Enter Group** on the Menu bar.
 - Use the keyboard shortcut *F3*.
 - Double-click on the selected group.
- 2) Once inside the group, click on any object to select and individually edit it (Figure 122).
- 3) After making changes to an individual object, exit the group using one of the following methods:
 - Right-click on the group and select **Exit Group** from the context menu.
 - Go to **Shape > Group > Exit Group** on the Menu bar
 - Use the keyboard combination *Ctrl+F3*.
 - Double-click outside the group.

Nesting groups

A group of groups can be created and this is commonly known as nesting groups. When nested groups are created, Draw retains the individual group hierarchy and remembers the order in which groups were selected. That is, the last individual group selected will be on top of all the other groups within a nested group. Ungrouping and entering a nested group works in exactly the same way as for individual groups.

Tip

If group and ungroup commands are regularly used, or any other command, tools can be added to a toolbar so that they are readily available. See the *Getting Started Guide* for more information on customizing the user interface.

Combining, splitting, breaking, and connecting

Combining objects

Combining objects is a permanent merging of objects creating a new object. The original objects are no longer available as individual objects and cannot be edited as individual objects.

- 1) Select several objects for combining.
- 2) Combine the selected objects into a single object using one of the following methods:
 - Right-click on the selection and select **Shapes > Combine** from the context menu.
 - Go to **Shape > Combine** on the Menu bar.
 - Use the keyboard combination *Ctrl+Shift+K*.

At first glance, the results can seem rather surprising, but the following explains how combining objects works.

- The attributes (for example, area fill) of the resulting object are those of the object furthest back. In Figure 123, it is the ellipse and Figure 124 it is the yellow rectangle.
- Where the objects overlap, the overlapping zone is either filled or empty depending on whether the overlap is even numbered or odd numbered. Figure 124 shows that where the overlap number is even, an empty space is created and where the overlap number is odd, a filled area is created.

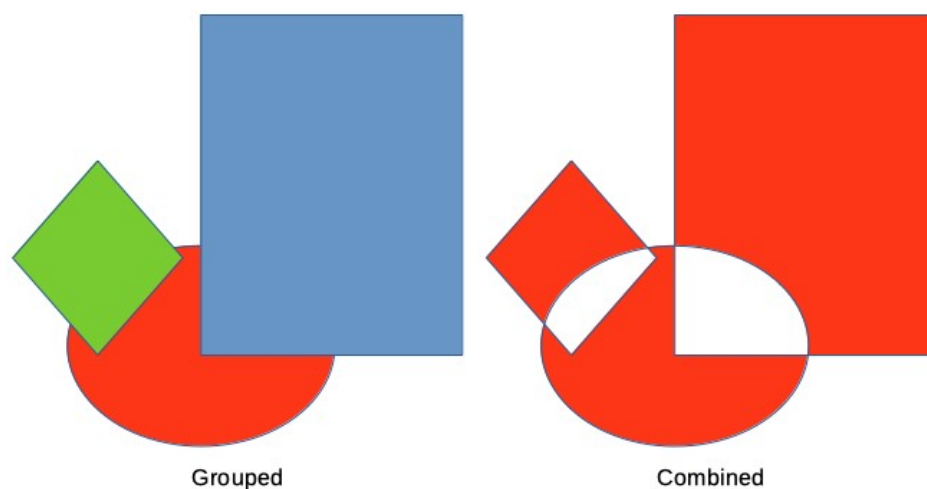
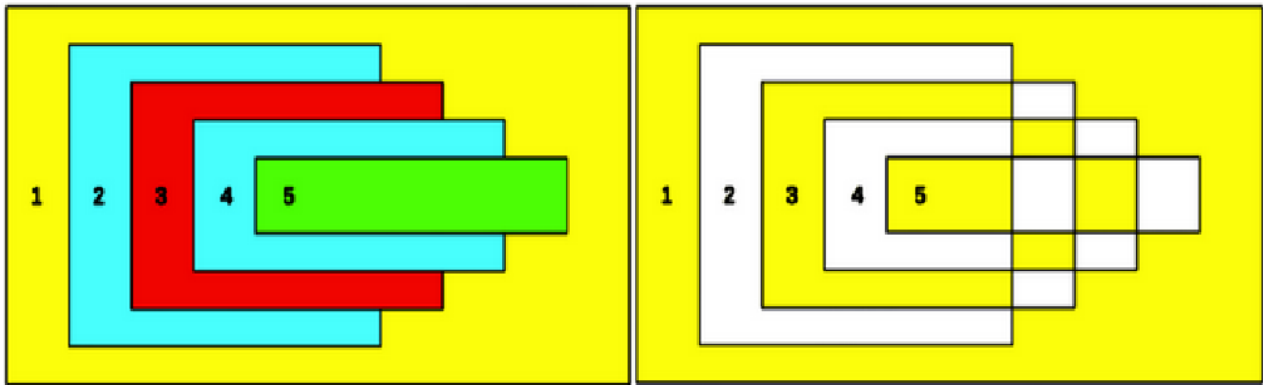

Figure 123: Combining objects



Overlapping objects

Combined overlapping objects

Figure 124: Example of area fill when combining overlapping objects

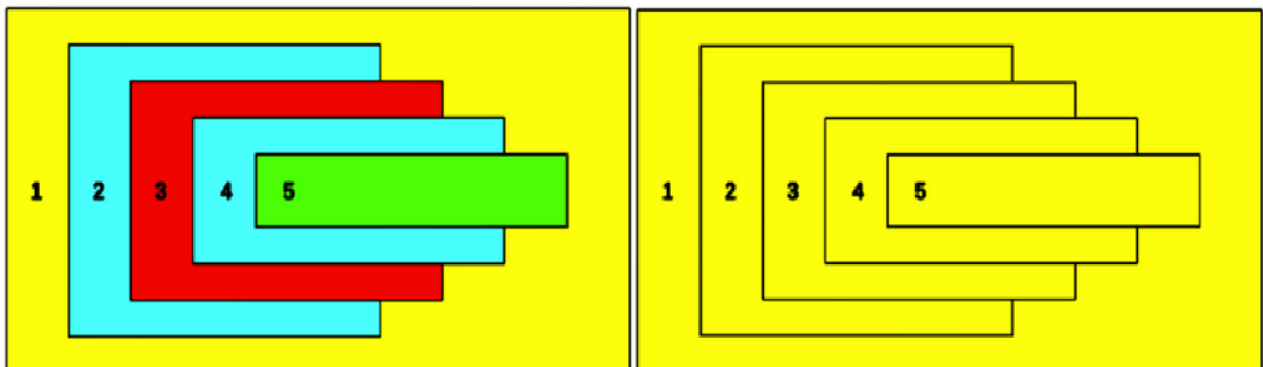

Overlapping objects before combining

Split result of combined overlapping objects

Figure 125: Example of splitting a combined object

Splitting combined objects

An object which has been combined from several objects can be split into individual objects. However, the original objects retain the formatting of the combined object and do not revert back to their original formatting.

Select the combined object and use one of the following methods to split the combined object:

- Go to **Shape > Split** on the Menu bar.
- Use the keyboard shortcut **Ctrl+Alt+Shift+K**.

In Figure 125, the left graphic is the original example of overlapping area fills before combining. The right graphic is the result of splitting the combined object. The individual overlapping objects have taken the formatting of the object (Rectangle 1) at the back of the overlapping objects.

Breaking objects

An object that consists of more than one part can be broken into its individual parts as follows. For example, a star is broken into separate lines and the area fill is lost, as shown by the center graphic in Figure 126.

- 1) Select an object that consists of more than one part.
- 2) Convert the object to a curve or polygon using one of the following methods:
 - Go to **Shape > Convert > To Curve** or **To Polygon** on the Menu bar.
 - Right-click on the object and select **Convert > To Curve** or **To Polygon** on the context menu.

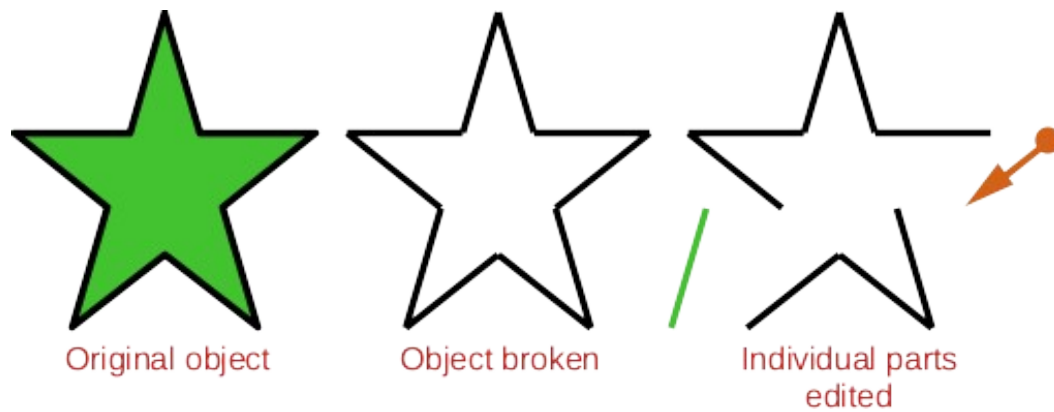

Figure 126: Example of breaking objects

- 3) Go to **Shape > Break** on the Menu bar and the object is broken into individual parts.
- 4) Move, format or delete the individual parts as necessary, as shown by the right object in Figure 126.

Connecting lines

The individual parts of an object or more than one line can be connected together as follows:

- 1) Select all the objects that are going to be connected.
- 2) Go to **Shape > Connect** on the Menu bar. Individual lines or lines in a border are converted to curves and the end points of each line connected.

✓ Note

The shape created when connecting individual parts or lines is not a closed shape. The new shape has to be closed using “Closing objects” to create an area fill.

Closing objects

Closing objects creates an object that can use an area fill.

- 1) Select an object that has a gap in its border.
- 2) Right-click on the selected object and select **Close Object** from the context menu to close the gap.
- 3) Format the area fill created to requirements. See Chapter 4, Changing Object Attributes for more information on working with area fills.

Merging, subtracting, or intersecting objects

After selecting more than one object, the merge, subtract, and intersect functions become available. This allows creation of a new object with a new shape.

Merge

When merging objects, a new object is created with a shape that follows the shape of the merged objects. The area fill of the merged object is determined by the area fill of the object that is at the rear of all the other objects, as shown in Figure 127.

After selecting several objects, use one of the following methods to merge the objects:

- Go to **Shape > Merge** on the Menu bar.
- Right-click on the selected objects and select **Shapes > Merge** from the context menu.

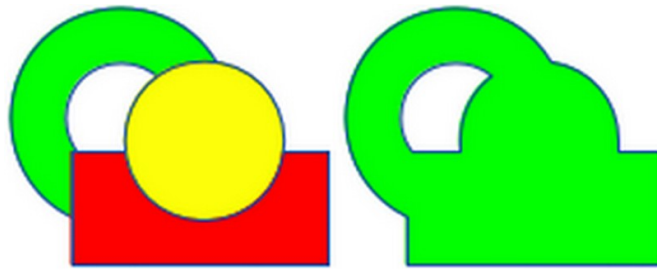

Figure 127: Merging objects

Subtract

When subtracting objects, the objects at the front are subtracted from the object behind. This leaves a blank space that the subtracted objects occupied creating a new shape, as shown in Figure 128. After selecting several objects that overlap each other, use one of the following methods to subtract objects:

- Go to **Shape > Subtract** on the Menu bar.
- Right-click on the selected objects and select **Shapes > Subtract** from the context menu.

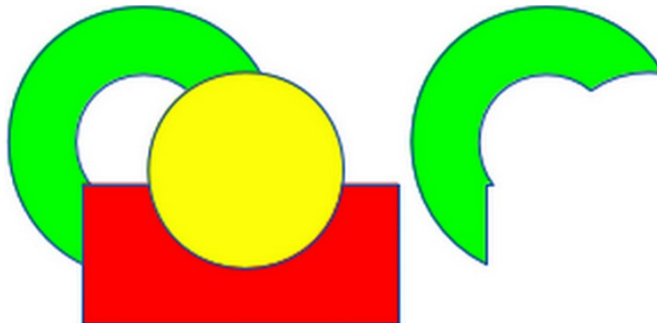

Figure 128: Subtracting objects

Intersect

When intersecting objects, the front objects and the exposed area of the object at the rear are removed. This creates a new object from the area of the object at the rear that was covered by the objects at the front, as shown in Figure 129.

After selecting several objects that overlap each other, use one of the following methods to intersect objects:

- Go to **Shape > Intersect** on the Menu bar.
- Right-click on the selected objects and select **Shapes > Intersect** from the context menu.

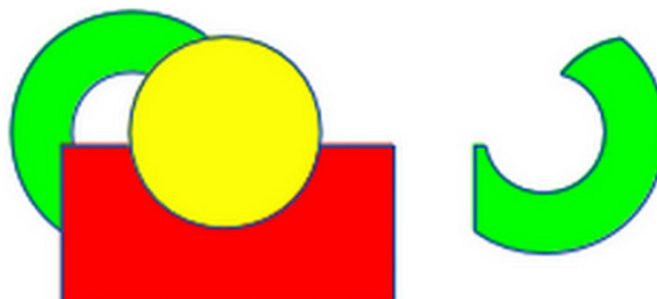

Figure 129: Intersecting objects

Practical example

The following example shows how to use the merge, subtract, and intersect functions to create a knife with a wooden handle.

Draw an ellipse and then a rectangle overlapping half of its width.



Select both shapes, right-click, and select **Shapes > Subtract** from the context menu.



Draw another rectangle and put it over the top half of the ellipse.



Select both shapes, right-click, and select **Shapes > Subtract** from the context menu.



Draw a small ellipse covering just the lower right corner.



Select both shapes, right-click, and select **Shapes > Subtract** from the context menu. The knife blade shape is now complete.



To make the handle, draw a rectangle and an ellipse.



Merge the shapes together.



Position the handle on the blade. Select the handle and blade, then group together to create a drawing of the knife.



Duplication and cross-fading

Duplication

Duplication makes copies of an object while applying a set of changes (such as color or rotation) to the duplicates.

- 1) Select an object or group of objects, then use one of the following methods to open the Duplicate dialog (Figure 130):
 - Go to **Edit > Duplicate** on the Menu bar.
 - Go to **Shape > Duplicate** on the Menu bar.
 - Use the keyboard shortcut *Shift+F3*.
- 2) Select the number of copies, placement, enlargement, and the start and end colors for duplicate copies.

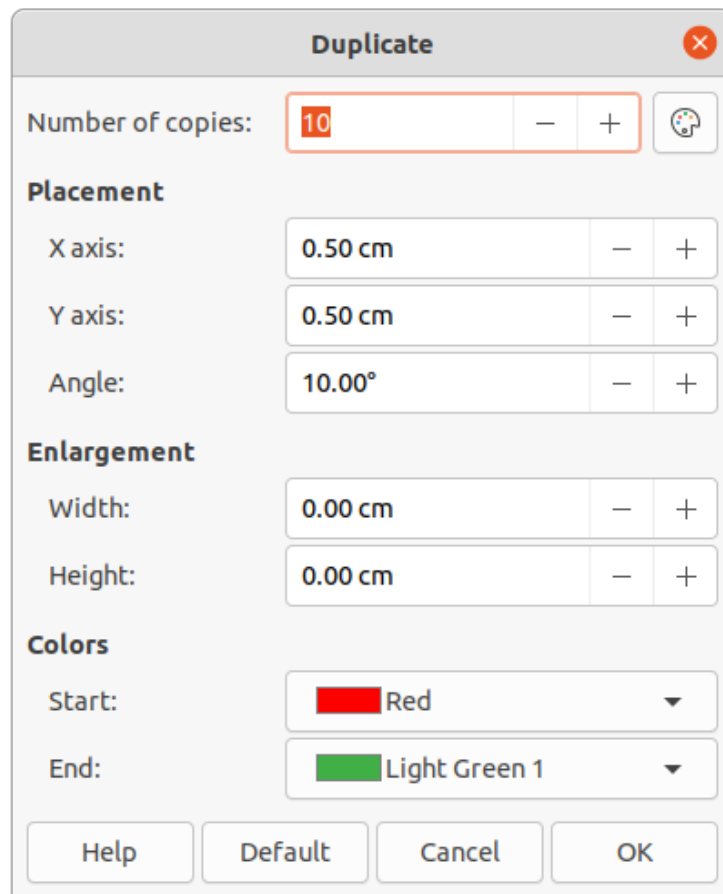

Figure 130: Duplicate dialog

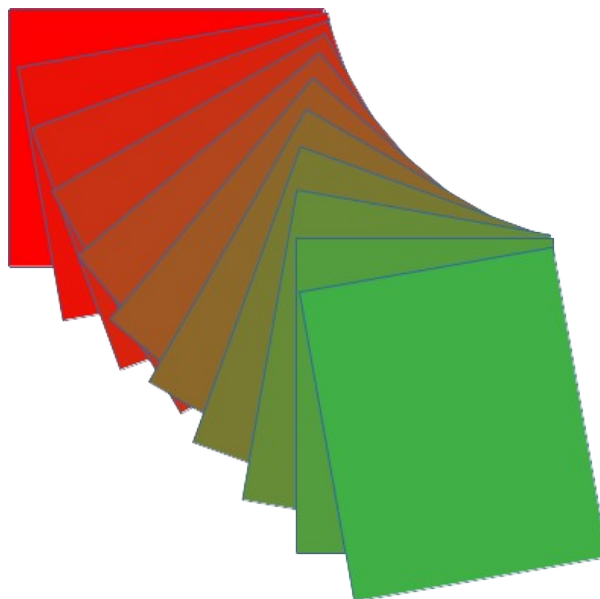

Figure 131: Duplication example

- 3) Click **OK** and duplicate copies are created. An example of a duplication is shown in Figure 131. Each duplicate object is a separate object.
- 4) To group the duplicate objects into one group, see “Grouping objects” on page 112.
- 5) To combine the duplicate objects into one object, see “Combining, splitting, breaking, and connecting” on page 114.

The following options are available when using the Duplicate dialog:

- **Number of copies** – enter the number of copies required.
- **Placement** – sets the position and rotation of duplicated objects in relation to the original object.
 - *X axis*-- enter the horizontal distance between the centers of the selected object and the duplicate objects. Positive values shift the duplicate object to the right and negative values shift the duplicate object to the left.
 - *Y axis* – enter the vertical distance between the centers of the selected object and the duplicate objects. Positive values shift the duplicate object down and negative values shift the duplicate object up.
 - *Angle* – enter the angle (0 to 359 degrees) required for rotating the duplicate object. Positive values rotate the duplicate objects in a clockwise direction and negative values in a counterclockwise direction.
- **Enlargement** – sets the size of the duplicate objects.
 - *Width* – enter the amount to enlarge or reduce the width of the duplicate objects.
 - *Height* – enter the amount to enlarge or reduce the height of the duplicate objects.
- **Colors** – sets the colors for the selected object and the duplicate objects. For more than one copy, these colors define the start and end points of a color gradient.
 - *Start* – select a color for the selected object.
 - *End* – select a color for the duplicate object. If making more than one copy, this color is applied to the last copy.

Cross-fading

Cross-fading transforms one object shape into another object shape. The result is a new group of individual objects that includes the start and end objects. The intermediate steps show the transformation from one object shape to another object shape. The cross-fading is carried out from the first object selected to the second object selected.

- 1) Select two objects and go to **Shape > Cross-fading** on the Menu bar to open the Cross-fading dialog (Figure 132).
- 2) Select the number of *Increments* for the transformation.
- 3) If necessary, select **Cross-fade attributes** and **Same orientation**.
- 4) Click OK to cross-fade the selected objects and close the Cross-fading dialog. An example of cross-fading is shown in Figure 133 with Same orientation deselected. The object created is a group of objects.

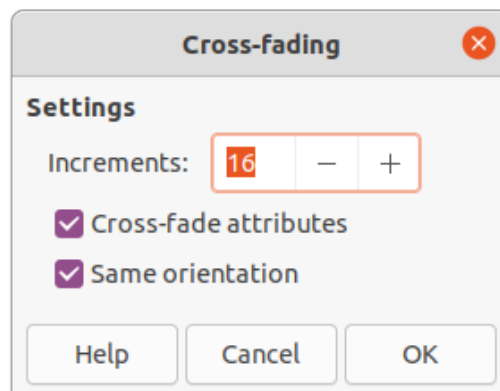

Figure 132: Cross-fading dialog

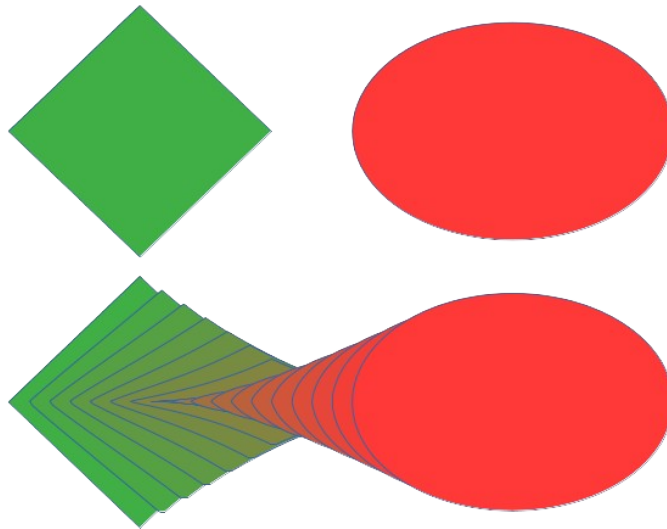

Figure 133: Cross-fading example

- 5) To ungroup this group of objects and use the individual objects, see “Ungrouping” on page 112.

The following options are available in the Cross-fading dialog:

- **Increments** – enter the number of steps to be created between the selected objects.
- **Cross-fade attributes** – applies cross-fading to the line and fill properties of the selected objects. For example, if the selected objects are filled with different colors, a color transition between the two colors is applied.
- **Same orientation** – applies a smooth transition between the selected objects.

Positioning objects

Arranging objects

When combining, merging, subtracting, or intersecting objects, the end result varies depending on which object is at the front and which object is at the back. Each new object placed on a drawing automatically becomes the front object and all the other objects move backwards in positioning order. Arranging objects changes the order in of a group of objects.

To change the arrangement position of an object, select one or more objects and then use one of the following methods

- Right-click on the selected object(s), then select **Arrange** from the context menu and one of the available options.
- Click on the triangle ▼ to the right of **Arrange** on the Standard toolbar to open the Position toolbar (Figure 134) and select one of the available tools.
- Click one of the arrangement tools on the Line and Filling toolbar.
- Click on **Shape > Arrange** on the Menu bar and select an arrangement option.
- Use the *Arrange* tools in **Position and Size** panel in the Properties deck on the Sidebar.
- Use a keyboard shortcut given below.

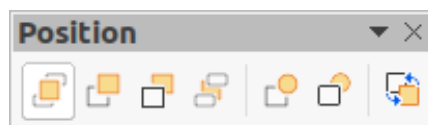

Figure 134: Position toolbar

The arrangement options available are as follows:

- **Bring to Front** (*Shift+Ctrl++*) – brings the selected object to the front of a group of objects.
- **Bring Forward** (*Ctrl++*) – brings the selected object forward one step.
- **Send Backward** (*Ctrl+-*) – sends the selected object one step backward.
- **Send to Back** (*Shift+Ctrl+-*) – sends the selected object to the back of a group of objects.
- **In Front of Object** – moves the selected object in front of another selected object.
- **Behind Object** – moves the selected object behind another selected object.
- **Reverse** – reverses the order of the selected objects. This tool is grayed out if only one object is selected.

✓ Note

The positioning tools can be turned into a floating toolbar by clicking at the top of the pop-up on the Standard toolbar and dragging it to a new position on a drawing, as shown in Figure 134.

Aligning objects

To make a drawing look more professional, objects can be aligned with each other. Select one or more objects and use one of the following methods to align objects:

- Right-click on the selected object(s), then select **Align Objects** from the context menu and one of the available options.
- Click on the triangle ▼ to the right of **Align** on the Standard or Line and Filling toolbars to open a pop-up toolbar (Figure 135).
- Go to **Shape > Align** on the Menu bar and select the alignment required.
- Use the *Align* tools in the **Position and Size** section in the Properties deck on the Sidebar.

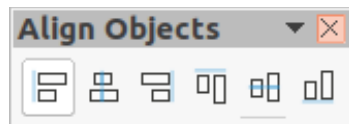

Figure 135: Align Objects toolbar

The alignment tools available are as follows:

- **Left** – aligns the left edges of the selected objects. If only one object is selected, the left edge of the object is aligned to the left page margin.
- **Centered** – horizontally centers the selected objects. If only one object is selected, the center of the object is aligned to the horizontal center of the page.
- **Right** – aligns the right edges of the selected objects. If only one object is selected, the right edge of the object is aligned to the right page margin.
- **Top** – vertically aligns the top edges of the selected objects. If only one object is selected, the top edge of the object is aligned to the upper page margin.
- **Center** – vertically centers the selected objects. If only one object is selected, the center of the object is aligned to the vertical center of the page.
- **Bottom** – vertically aligns the bottom edges of the selected objects. If only one object is selected, the bottom edge of the object is aligned to the lower page margin.

✓ Note

The alignment tools can be turned into a floating toolbar by clicking at the top of the pop-up toolbar and dragging it to a new position on a drawing workspace, as shown in Figure 135.

Distributing objects

Distributing objects allows three or more objects to be evenly spaced along a horizontal axis or vertical axis. Objects are distributed using the outermost selected objects as base points for spacing.

Select at least three objects, then use one of the following methods to distribute the objects:

- Right-click on the selected objects, then select **Distribute Selection** from the context menu and one of the available options.
- Click on the triangle ▼ to the right of **Distribute Selection** on the Standard toolbar to open a pop-up toolbar (Figure 136).
- Go to **Shape > Distribute Selection** on the Menu bar and select a distribution option.
- Right-click on the selected objects and select **Distribute Selection** from the context menu, then select a distribution option.



Figure 136: Distribute Selection toolbar

The distribution options available are as follow:

- **Horizontal Left** – distributes the selected objects so that the left edges of the objects are evenly spaced from one another.
- **Horizontal Center** – distributes the selected objects so that the horizontal centers of the objects are evenly spaced from one another.
- **Horizontal Spacing** – distributes the selected objects horizontally so that the objects are evenly spaced from one another.
- **Horizontal Right** – distributes the selected objects so that the right edges of the objects are evenly spaced from one another.
- **Vertical Top** – distributes the selected objects so that the top edges of the objects are evenly spaced from one another.
- **Vertical Center** – distributes the selected objects so that the vertical centers of the objects are evenly spaced from one another.
- **Vertical Spacing** – distributes the selected objects vertically so that the objects are evenly spaced from one another.
- **Vertical Bottom** – distributes the selected objects so that the bottom edges of the objects are evenly spaced from one another.

✓ Note

The distribution tools can be turned into a floating toolbar by clicking at the top of the pop-up toolbar and dragging it to a new position on a drawing workspace, as shown in Figure 136.



LibreOffice
Community



Draw Guide 7.2

Chapter 6, Editing Images

Raster Graphics

Introduction

Previous chapters in this Draw Guide have dealt only with vector graphics and the most common types of vector graphics in use are as follows:

- **SVG** (Scalable Vector Graphics) – an Extensible Markup Language (XML) based vector image format for two-dimensional graphics with support for interactivity and animation.
- **EPS** (Encapsulated PostScript) – a PostScript document format usable as a graphics file format. EPS files are more-or-less self-contained, reasonably predictable PostScript documents that describe an image or drawing and can be placed within another PostScript document.
- **AI** (Adobe Illustrator) – a proprietary file format developed by Adobe Systems for representing single-page vector-based drawings in either the EPS or PDF formats.

However, Draw also contains a number of functions for handling raster graphics (bitmaps) such as photographs and scanned pictures, including import, export, and conversion from one format to another.

Draw can read all the majority of graphic file formats. It has a subset of capabilities similar to raster graphics programs like Adobe Photoshop or Gimp. Raster graphics are generally images or pictures that use one of the following formats, which are the most common formats in use:

- **JPG/JPEG** – acronym for Joint Photographic Experts Group which created the format. It is the most common image format on websites and most digital cameras produce JPEG images as default.
- **GIF** (Graphics Interchange Format) – GIF is a bitmap image format that is popular because of its wide support and portability.
- **PNG** (Portable Network Graphics) – PNG is a raster image format which supports lossless data compression and also background transparency.
- **TIF/TIFF** (Tagged Image File Format) – TIFF is flexible, adaptable, and capable of storing image data in a lossless format.
- **BMP** (BitMaP) – it is also known as bitmap image file, which is a dot matrix data structure.

Importing images

Inserting

To import image files into a drawing, go to **Insert > Image** on the Menu bar or click on **Insert Image** on the Standard toolbar to open the Insert Image dialog (Figure 137).

Draw contains import filters for the majority of graphic formats. If the file being imported has a graphic format not covered by the import filters, then it is recommended to use one of the many free graphic conversion programs to convert the file into a format that Draw recognizes.

If **Preview** is selected in the Insert Image dialog, a preview of the file is shown in the box on the right-hand side. This makes it easier to select the file required and also checks that Draw can import the file format used.

Embedding

Embedding a graphic into a drawing makes the image a permanent part of the drawing. Any changes made to an embedded graphic only appear in the drawing where the graphic was embedded. The original graphic file is not affected.

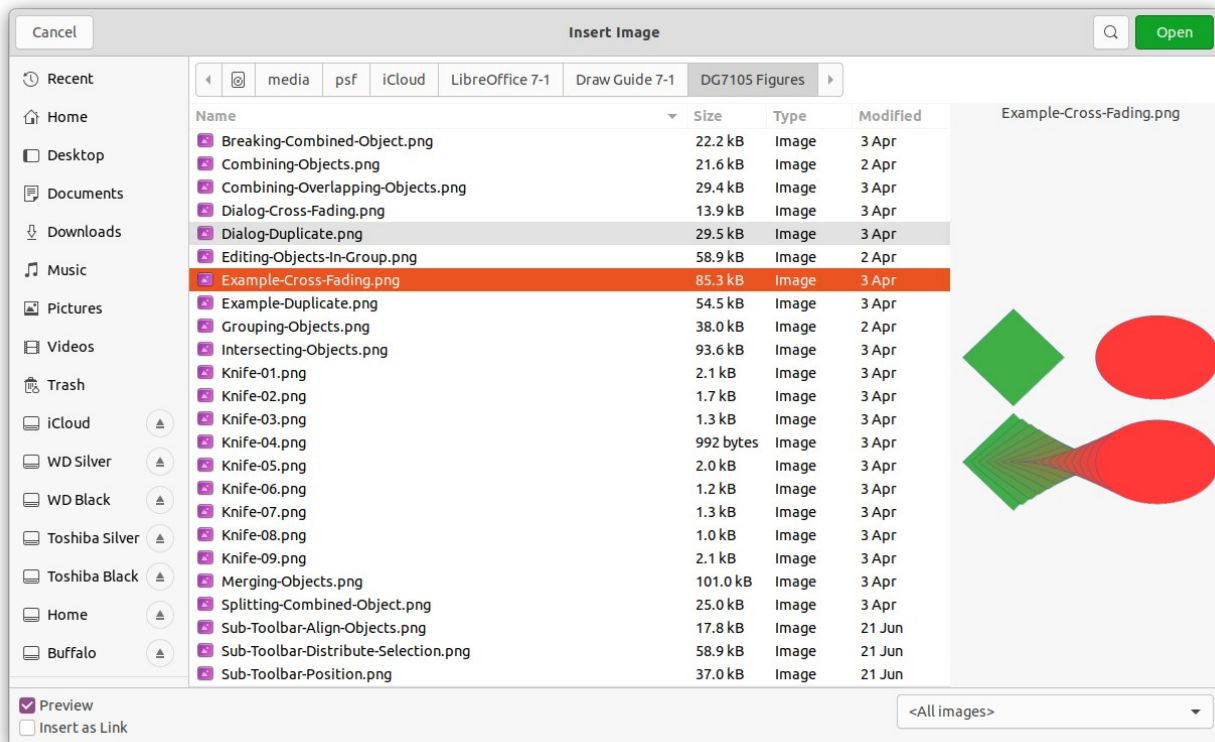

Figure 137: Insert Image dialog

Embedding happens when a graphic is imported into a drawing using one of the following methods:

- Insert Image dialog.
- Copying and pasting.
- Scanning a graphic.
- Dragging and dropping between open files.

The main advantage of embedding graphics into a drawing is that the graphic is always available no matter what computer is used to open the drawing.

The main disadvantage of embedding graphics is that it creates large file sizes, which may not be desirable if there is limited capacity for storing computer files. Also, if the original graphic is altered, then the embedded graphic is not updated each time the drawing is opened.

✓ Note

When a graphic is to be embedded into a LibreOffice drawing, make sure that the **Insert as Link** option is not selected in the Insert Image dialog.

Linking

Linking to the original graphic does not insert the graphic into a drawing, but creates a link to where the original graphic file is located on the computer. Each time the drawing is opened, any linked graphics are displayed in the drawing.

The main advantage of linking a graphic file when placed in a drawing is that if the original graphic file is altered or replaced with a graphic using the same filename, the version of the graphic in the drawing is always up to date. The next time the drawing is opened, the latest version of the graphic is also opened in the drawing. Also the file size of the drawing is much smaller and the original graphic can easily be edited with specialized external applications.

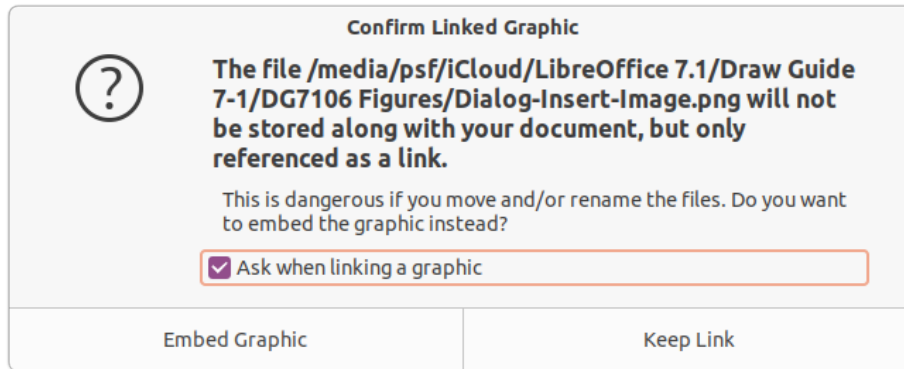

Figure 138: Confirm Linked Graphic dialog

The main disadvantage of linking graphics is that the link must be maintained between the drawing and the embedded graphic file for linking to work correctly. If the drawing or original graphic file is moved to another computer location, then any links must be updated to include the new location.

- 1) Open the Insert Image dialog.
- 2) Select **Insert as Link** in the Insert Image dialog.
- 3) Select the required graphic file and click on **Open** to open the Confirm Linked Graphic dialog (Figure 138).
- 4) Click on **Keep Link** to link the file and close the Confirm Linked Graphic dialog.
- 5) If necessary, click on **Embed Graphic** to embed the file if it is not to be linked. This also closes the Confirm Linked Graphic dialog.

✓ Note

When a graphic file is linked to a LibreOffice drawing, the format of the linked graphic is not changed.

Editing links

Links can be updated, modified, or broken as follows:

- 1) Go to **Edit > Links to External File** on the Menu bar to open the Edit Links dialog (Figure 139).
- 2) Select the link to be edited.
- 3) Click on **Modify**, **Break Link**, or **Update** as appropriate.
 - **Modify** – changes the graphic file in the drawing to the graphic file that uses the selected link.
 - **Break Link** – breaks the link between the selected file and the current document. The version of the graphic file in the drawing becomes embedded into the drawing. A confirmation dialog opens asking if the link is to be broken. Click on **Yes** to confirm the breaking of the link.
 - **Update** – updates the selected link so that the most recent version of the linked file is displayed in the drawing.
- 4) Click on **Close** to save the changes to the link and close the Edit Links dialog.

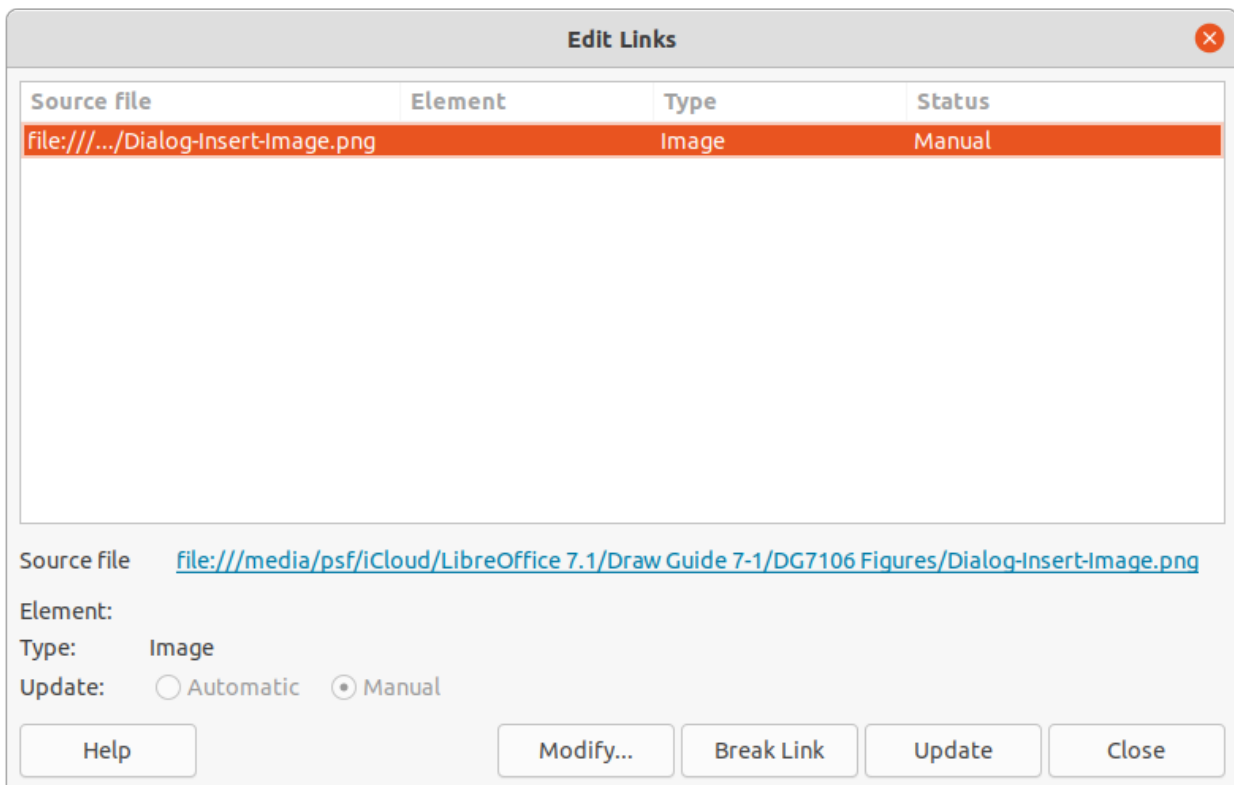

Figure 139: Edit Links dialog

Scanning

With most scanners a scanned image can be inserted into a drawing or document. Scanned images are embedded using PNG format. Make sure the scanner is configured for the computer and supported by the SANE system for a Linux operating system, or TWAIN for a Windows or Mac operating system.

- 1) Place a document, drawing, or photograph in the scanner and make sure that the scanner is switched on and ready.
- 2) If this is the first time the scanner has been used with LibreOffice, go to **Insert > Media > Scan > Select Source** on the Menu bar to select the scanner. If the scanner has been used before, go to **Insert > Image > Scan > Request** on the Menu bar.
- 3) The rest of the procedure depends on the scanner driver, interface, and computer operating system. Normally, scanning options need to be specified such as resolution, scan window, and so on. Consult the documentation that came with the scanner for more information.
- 4) When the image has been scanned, Draw places it in the drawing. At this point it can be edited like any other graphic.

Note

If more than one scanning device is connected to the computer, the device is selected when the source is selected. This selection becomes the default source when using scan requests until another device is selected and used as the scanning source.

Copying and pasting

Copying and pasting a graphic into a drawing is another way of embedding graphics. The copied graphic can be an image already embedded in another document or drawing, or it can be a graphic file such as a drawing, document, or photograph.

After copying, select the format for pasting a graphic into Draw using **Edit > Paste Special > Paste Special** on the Menu bar to open the Paste Special dialog. Available formats for pasting depend on the type of image copied onto the clipboard.

Note

When copying and pasting images into a drawing, please respect the copyright and license of the image being copied.

Dragging and dropping

Dragging and dropping is another method of embedding graphics into a drawing and can be used on graphics that have been embedded or linked. The way that dragging and dropping works is determined by the computer operating system. Behavior of dragging and dropping is normally controlled using the *Ctrl* or *Ctrl+Shift* keys in combination with the mouse.

Objects and images which are used frequently can be stored in the Draw Gallery. From the Gallery, a copy of the object or image can be simply dragged onto the drawing. Working with the Gallery is dealt with in Chapter 11, Advanced Draw Techniques.

Exporting graphics

Exporting files

By default Draw saves drawings in the `*.ODG` format and some software programs cannot open these files. To make drawings available for other programs, the file can be exported in various formats. The export procedure used depends on the computer setup and computer operating system being used. The following procedure is an example export procedure.

- 1) Open the ODG file being exported.
- 2) Go to **File > Export** on the Menu bar and open the Export dialog. An example of an export dialog is shown in Figure 140.
- 3) Enter a new filename for the exported file and navigate to the folder where the exported file is to be saved.
- 4) Select the required file format from the options in the drop-down list.
- 5) Click **Export** and the file is exported as a new file in the selected file format.
- 6) Depending on the file format selected, another dialog may open allowing options to be selected for the export format.
- 7) Depending on the additional dialog that may open, click on **Export**, **Create**, or **OK** and the file is exported as a new file in its new format.

Exporting objects

Exporting individual objects, or a group of objects, from a drawing file is similar to “Exporting files” above. Open a drawing file and then select the object or objects for export. Make sure to choose the **Selection** option in the export dialog, as shown in Figure 140.

Using this method, an imported image can be modified, annotations added to it, and make any other changes, then select it and export for use in another drawing or document.

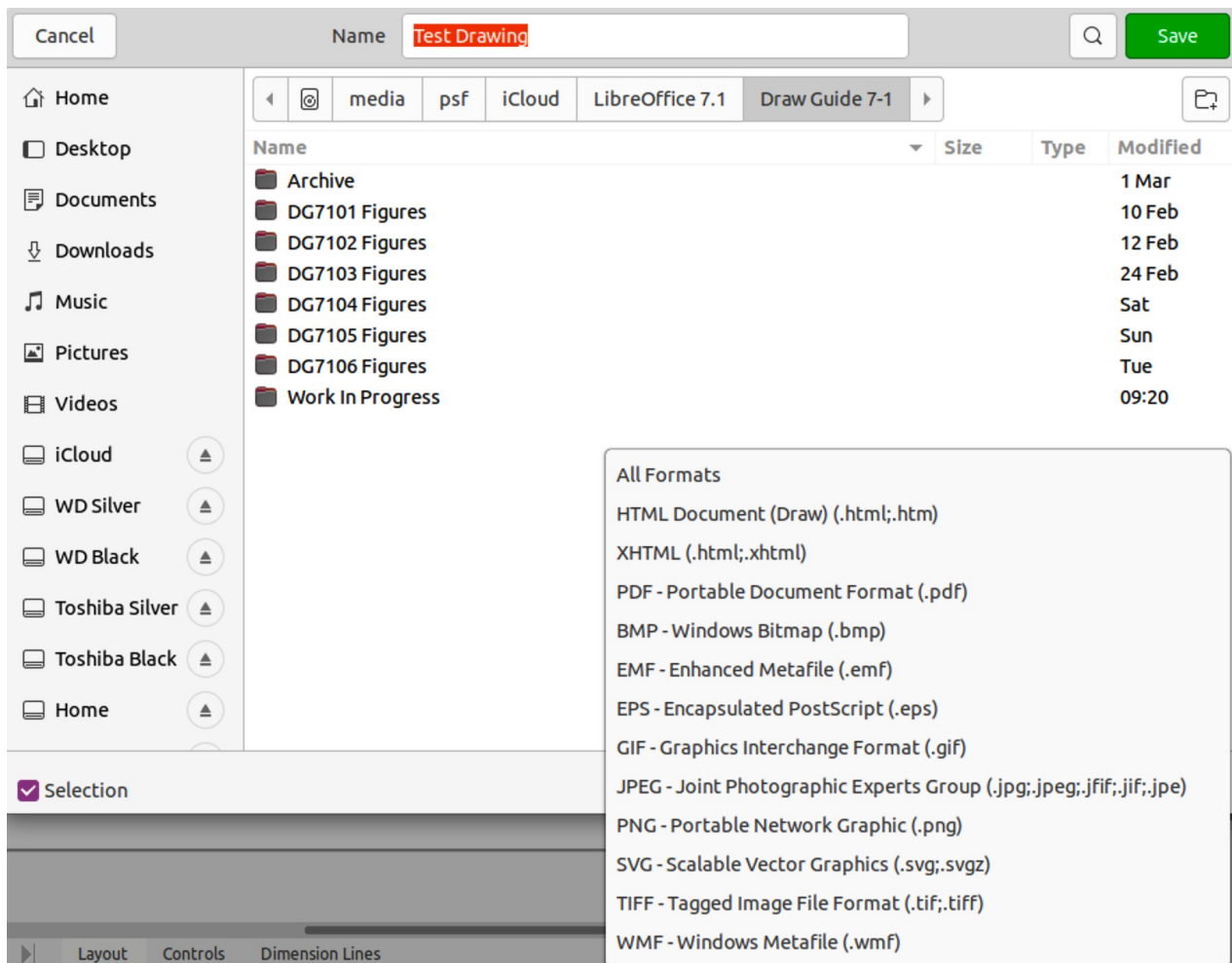



Figure 140: Example export dialog

Formatting images (raster objects)

Images (raster graphics) can be edited and formatted using one of the following methods to add or change filters and adjust the properties of color, lines, areas, and shadows:

- Go to **Format > Image** on the Menu bar and use one of the tools in the sub-menu that opens.
- Use the tools on the Image toolbar. See “Image toolbar” on below for more information.
- Use the tools available in the **Shadow** and **Image** panels on the Properties deck of the Sidebar (Figure 142 on page 132).
- Some raster graphics may have a text element. For more information on formatting text, see Chapter 9, Adding and Formatting Text.

Raster graphics included in a group behave like other objects when the properties of the group are edited and formatted.

 **Note**

Any formatting changes made to a graphic using the tools in LibreOffice only appear in the drawing where the graphic was modified. The original graphic file is not affected.

Naming images

Draw names objects, including inserted images, Shape 1, Shape 2, and so on, in the order of insertion into a drawing. It is recommended to rename objects, including images in a drawing, with a unique name. Names make images and other objects easily identifiable in the LibreOffice Navigator.

- 1) Select an image, then use one of the following methods to open the Name dialog and create a unique name for the selected image:
 - Go to **Format > Name** on the Menu bar.
 - Right-click on the image and select **Name** from the context menu.
- 2) Enter a name in the *Name* box and click **OK**.

Image toolbar

The Image toolbar (Figure 141) normally appears when an image or picture that is a raster graphic is selected. The Image toolbar can be fixed at the top of a drawing or as a floating toolbar. The default set of tools on the Image toolbar are as follows. For more information on the Image toolbar and the available tools, see Appendix B, Toolbars.

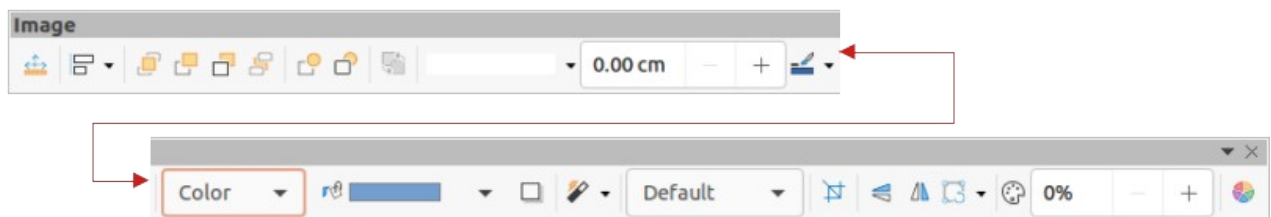

Figure 141: Image toolbar

- **Position and Size** (*F4*) – opens the Position and Size dialog. See Chapter 3, Working with Objects for more information.
- **Align Objects** – opens a sub-toolbar giving access to alignment tools for aligning selected objects in relation to each other. See Chapter 5, Combining Multiple Objects for more information.
- **Bring to Front** (*Shift+Ctrl++*) – brings the selected object to the front of a group of objects.
- **Bring Forward** (*Ctrl++*) – brings the selected object forward one step.
- **Send Backward** (*Ctrl+-*) – sends the selected object one step backward.
- **Send to Back** (*Shift+Ctrl+-*) – sends the selected object to the back of a group of objects.
- **In Front of Object** – moves the selected object in front of another selected object.
- **Behind Object** – moves the selected object behind another selected object.
- **Reverse** – reverses the order of the selected objects. This tool is grayed out if only one object is selected.
- **Line Style** – opens a drop-down list with different line styles used for the outline of the border. See Chapter 4, Changing Object Attributes for more information.
- **Line Width** – used to change the width of a line. See Chapter 4, Changing Object Attributes for more information.
- **Line Color** – used to change the color of a line. See Chapter 4, Changing Object Attributes for more information.
- **Area Style/Filling** – used to change the type of filling used in a shape. See Chapter 4, Changing Object Attributes for more information.

- **Shadow** – sets the default shadow effect around the picture. The shadow attributes are adjusted using the **Shadow** panel in the Properties deck on the Sidebar (Figure 142). See Chapter 4, Changing Object Attributes for more information.
- **Filter** – opens the Image Filter toolbar which is described in “Image filters” on page 137.
- **Image Mode** – changes the display of the graphic from color to grayscale, black and white, or a watermark. This setting affects only the display and printing of the picture; the original picture file remains unchanged. The image mode setting can also be changed using *Color mode* in the **Image** panel in the Properties deck on the Sidebar (Figure 142).
 - *Default* – the graphic is displayed unaltered in color.
 - *Grayscale* – the graphic is displayed in 256 shades of gray.
 - *Black/White* – the graphic is displayed in black and white.
 - *Watermark* – the color, brightness, contrast, and gamma settings are reduced so that the graphic can be used as a watermark (background). The default settings for *Watermark* can be adjusted using the Color toolbar (Figure 143).

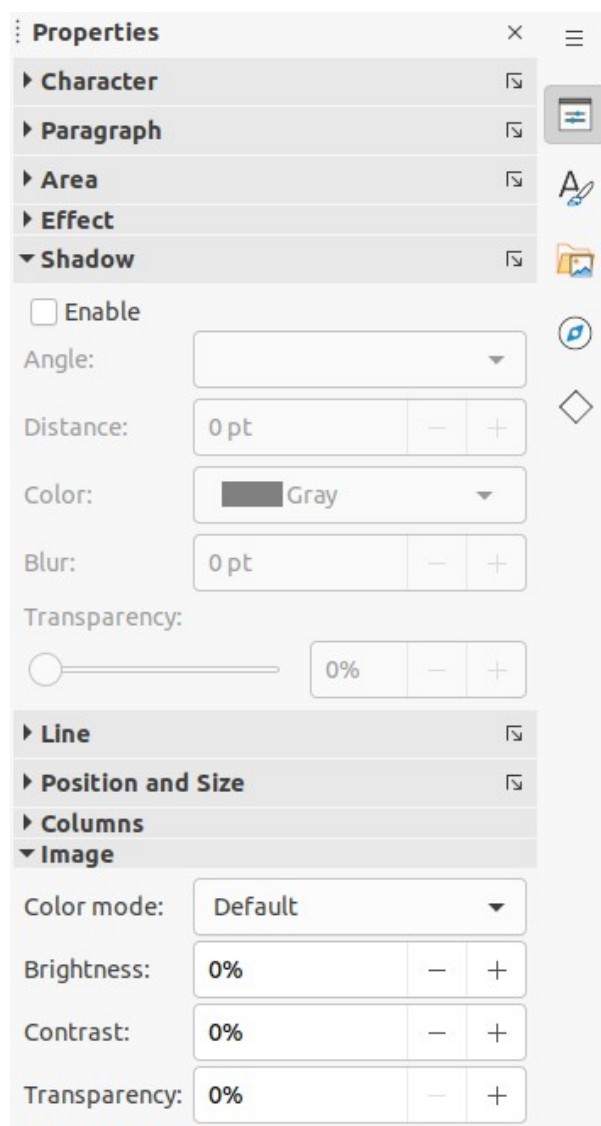

Figure 142: Shadow and Image panels in Properties deck on Sidebar

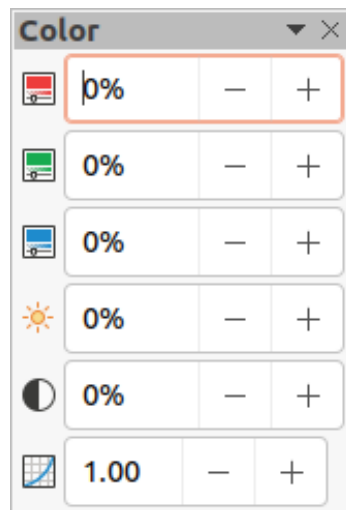

Figure 143: Color toolbar

- **Crop Image** – crops or trims a picture. When using this tool, crop marks appear around the picture. Drag one or more of these marks to crop the picture to the desired size. For more information on cropping, see “Cropping images” on page 133.
- **Vertically** – flips the selected object vertically. See Chapter 4, Changing Object Attributes for more information.
- **Horizontally** – flips the selected object horizontally. See Chapter 4, Changing Object Attributes for more information.
- **Transformations** – opens the Transformations toolbar. See Chapter 4, Changing Object Attributes for more information.
- **Transparency** – adjusts the degree of transparency of the picture between 0% (opaque) and 100% (fully transparent). The transparency setting can also be adjusted using the **Image** section in the Properties deck on the Sidebar.
- **Color** – opens the Color toolbar (Figure 143) to adjust the values of the RGB colors, brightness, contrast, and Gamma. These adjustments do not affect the original picture, but the values are stored in Draw as a separate formatting set. The color settings can also be adjusted using the **Image** section in the Properties deck on the Sidebar.
 - *Red, Green, Blue* – select values between –100% (no color) to +100% (full intensity); 0% represents the original color value of the graphic.
 - *Brightness* – select a value between –100% (totally black) and +100% (totally white).
 - *Contrast* – select a value between –100% (minimum) and +100% (maximum).
 - *Gamma* – this affects the brightness of the middle color tones. Select a value between 0.10 (minimum) to 10 (maximum) Try adjusting this value if changing brightness or contrast does not give the required result.

Cropping images

Cropping is a method of hiding unwanted areas of an image or changing the size of an image in a drawing. Changes made when cropping an image only change the display of the graphic in a drawing and not the original graphic file.



Figure 144: Example image ready for cropping with selection handles

Quick cropping

After selecting a graphic, it can be cropped quickly using one of the following methods:

- Click on **Crop Image** on the Standard or Image toolbar.
- Go to **Format > Image > Crop** on the Menu bar.
- Right-click on the image and select **Crop** from the context menu.

Selection handles appear around the selected image (Figure 144) and the image is cropped as follows:

- Top, bottom, left, and right selection handles crop the image in one direction only.
- Corner selection handles crop the image vertically and horizontally in two directions.
- To maintain the ratio between vertical and horizontal dimensions, hold down the *Shift* key while moving a selection handle.

Crop dialog

For more control and accuracy over the cropping functions, it is recommended to use the Crop dialog (Figure 145). After selecting an image, go to **Format > Image > Crop Dialog** on the Menu bar to open the Crop dialog.

- **Crop** – use this section to trim or scale the selected graphic, or to add white space around the graphic.
 - *Keep scale* – maintains the original scale of the graphic when cropping so that only the size of the graphic changes.
 - *Keep image size* – maintains the original size of the graphic when cropping so that only the scale of the graphic changes. To reduce the scale of the graphic, select this option and enter negative values in the cropping boxes. To increase the scale of the graphic, enter positive values in the cropping boxes.

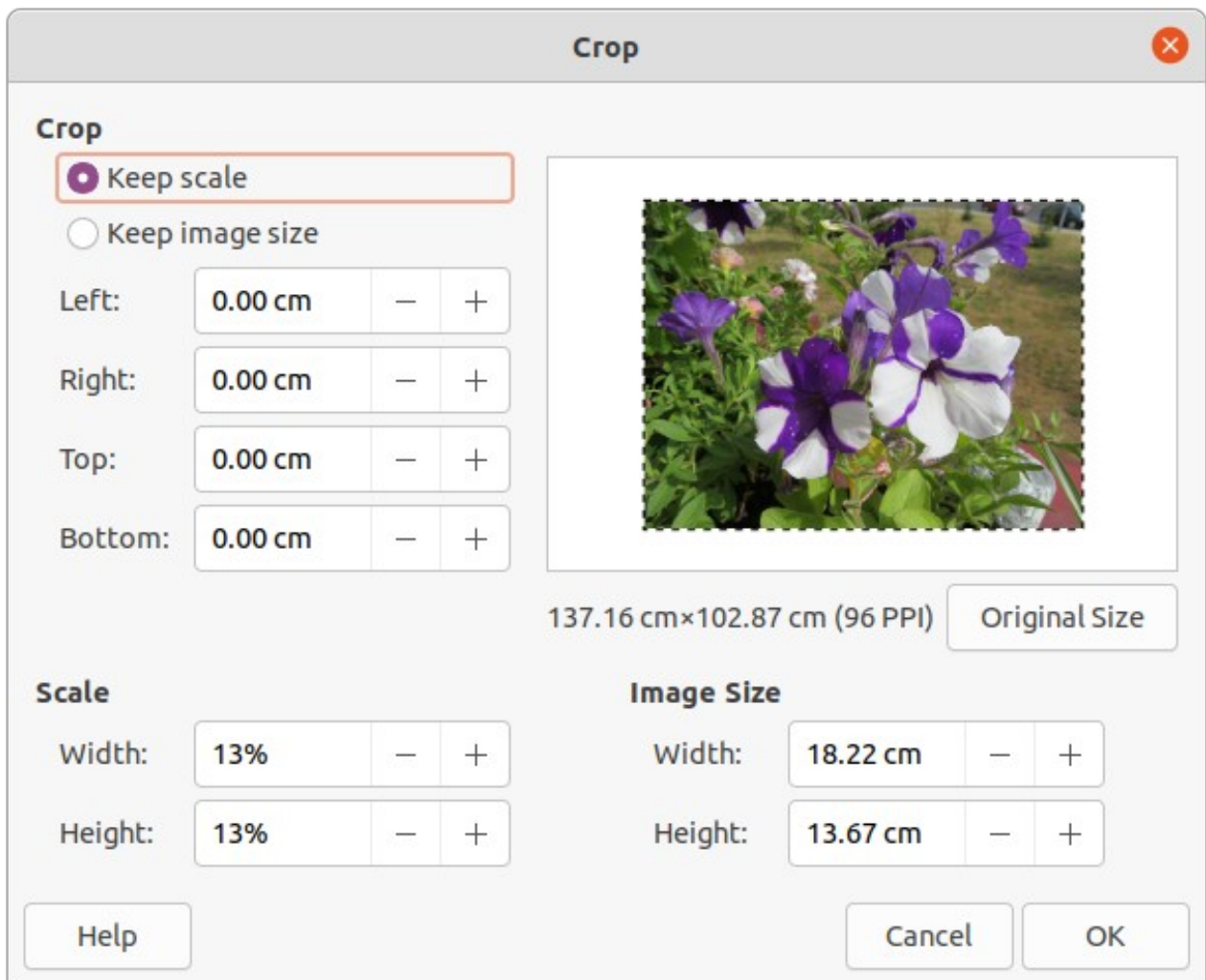

Figure 145: Crop dialog

- *Left* and *Right* – if *Keep scale* is selected, enter a positive amount to trim the left or right edge of the graphic, or a negative amount to add white space to the left or right of the graphic. If *Keep image size* is selected, enter a positive amount to increase the horizontal scale of the graphic, or a negative amount to decrease the horizontal scale of the graphic.
- *Top* and *Bottom* – if *Keep scale* is selected, enter a positive amount to trim the top or bottom of the graphic, or a negative amount to add white space above or below the graphic. If *Keep image size* is selected, enter a positive amount to increase the vertical scale of the graphic, or a negative amount to decrease the vertical scale of the graphic.
- **Scale** – this section is used to change the scale of the selected graphic as it appears in a drawing.
 - *Width* – enter a percentage value to change the width of a selected graphic.
 - *Height* – enter a percentage value to change the height of a selected graphic.
- **Image Size** – this section is used to change the size of the selected graphic.
 - *Width* – enter a value for the width of the selected graphic.
 - *Height* – enter a value for the height of the selected graphic.
- **Original Size** – the original size of the graphic is displayed above the option. Clicking on this option and then clicking **OK** resets the selected graphic to its original size.

✓ Note

In the Crop dialog, the *Width* and *Height* are treated as independent values. Changing one without the other can result in significant distortion of the image and this may not be what is required.

Exporting cropped graphics

If a cropped graphic is to be used in another drawing, use one of the following methods after selecting the cropped graphic:

- Go to **File > Export** on the Menu bar to open the Export dialog. Navigate to the destination folder, then enter a filename, choose the **Selection** option, and click on **Export**. See “Exporting graphics” on page 129 for more information.
- Go to **Format > Image > Save** on the Menu bar or right click on the cropped graphic and select **Save** from the context menu. Click on **Yes** to save the modified image and open an Image Export dialog. Select the file format required, navigate to the destination folder, then enter a filename and click on **Save**.

Compressing images

If a large image is inserted into a drawing and resized to fit into the layout of the drawing, the complete full-size original image is stored in the drawing file. This preserves its content, possibly resulting in a large file to store or send by mail.

If some loss of image quality can be accepted, the image can be compressed reducing its data volume while preserving its display in the page layout;

- 1) Open the Compress Image dialog (Figure 146) using one of the following methods:
 - Right-click on the image and select **Compress** from the context menu.
 - Go to **Format > Image > Compress** on the Menu bar.

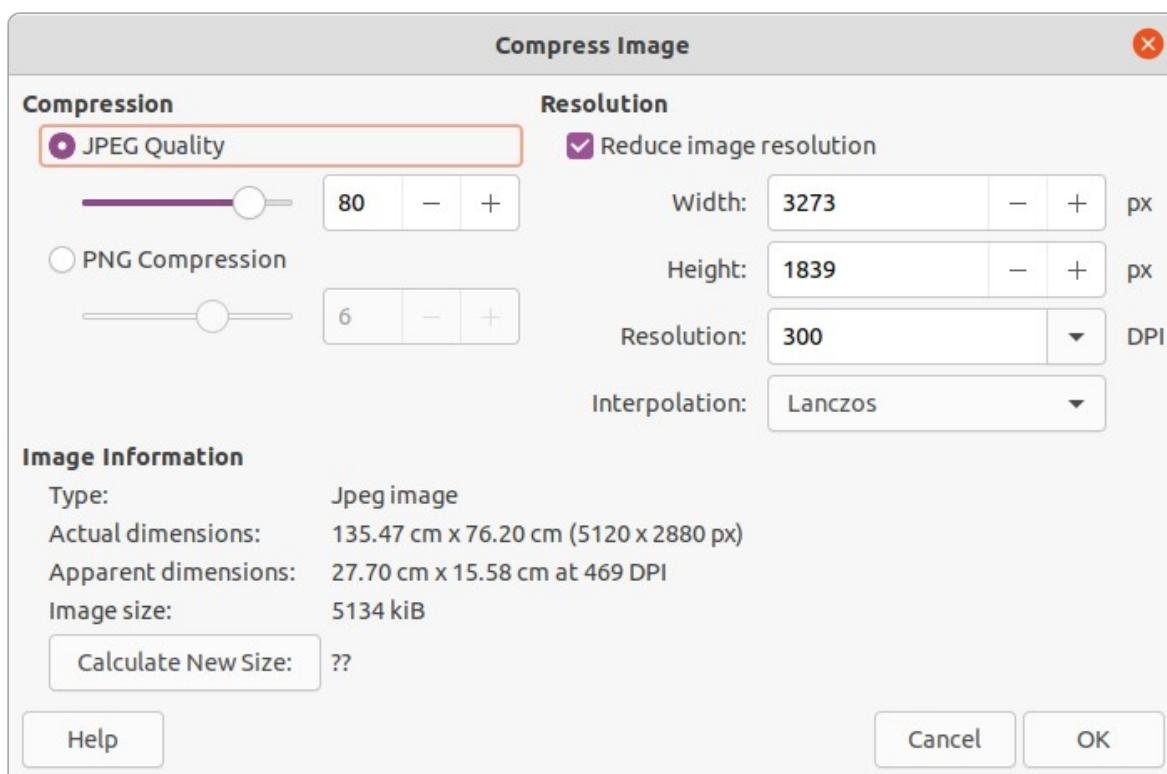

Figure 146: Compress Image dialog

- 2) Select the type of compression and the resolution required.
- 3) Click on **Calculate New Size** to update the image information when the **Compression** and **Resolution** settings are changed.
- 4) When satisfied with the new settings, click **OK** to apply the settings.
- 5) If the resulting image is not acceptable, use the keyboard shortcut *Ctrl+Z* to undo the changes and select another compression setting.

Image filters

Draw offers eleven filter effects that work on a selected graphic and they can be combined. Filters always apply to the entire graphic and it is not possible to use filters to edit only a part of the graphic.

- 1) Select a raster graphic to open the Image toolbar.
- 2) Apply an image filter using one of the following methods:
 - Click on **Filter** to open the Image Filter toolbar (Figure 147), then select an image filter to apply.
 - Go to **Format > Image > Filter** on the Menu bar and select an image filter from the context menu.

✓ Note

If a graphic is embedded into a drawing, any image filters are applied directly to a selected graphic and the original graphic file is not changed. Save the drawing to retain any filter effects applied to the graphic in a drawing.

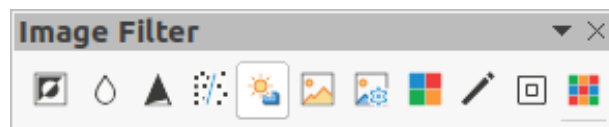

Figure 147: Image Filter toolbar

✓ Note

After a drawing is saved and closed, the effects of image filters become permanent. If image filter effects are not satisfactory, use **Edit > Undo** on the Menu bar to cancel the filter effects before saving the drawing.

The image filters available for application to a raster graphic are as follows:

- **Invert** – inverts or reverses the color values of a color image (similar to a color negative), or the brightness values of a grayscale image. Apply the filter again to revert to the original graphic (Figure 148).



Original

Invert

Figure 148: Invert image filter

- **Smooth** – softens or blurs the image by applying a low pass filter. This reduces the contrast between neighboring pixels and produces a lack of sharpness making the image appear smoother (Figure 149). The effect of the smooth filter can be very subtle. However, the following example shows the **Smooth** image filter applied at a *Smooth radius* setting of 50 making the image smooth, but blurred.

Selecting this filter opens the Smooth dialog (Figure 150) where the smooth radius parameter is set.



Original

Smooth

Figure 149: Smooth image filter

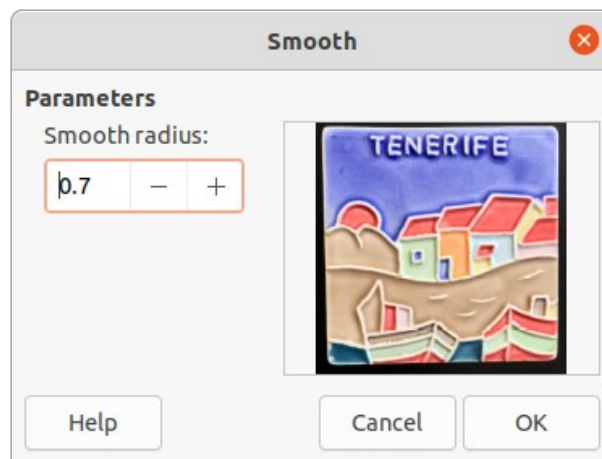

Figure 150: Smooth dialog

- **Sharpen** – sharpens the image by applying a high pass filter, adjusting the contrast between neighboring pixels. The effect increases if the filter is applied several times making the colors appear faded, as shown by the example in Figure 151.



Original

Sharpen

Figure 151: Sharpen image filter

- **Remove Noise** – removes noise by applying a median filter comparing every pixel with its neighbor. It then replaces any pixel with extreme values that deviate in color by a large amount from the mean value with a pixel that has a mean color value. The amount of picture information does not increase each time the filter is applied. However, there are fewer contrast changes resulting in an image that looks smoother and the effect is very subtle (Figure 152).



Original Remove Noise
 Figure 152: Remove Noise image filter

- **Solarization** – solarization refers to an effect that looks like what can happen when there is too much light during photo development and the colors have become partly inverted. Dark areas appear light or light areas appear dark. In the digital world of photography, solarization creates a change or reversal of color (Figure 153), similar to the effect of the **Invert** image filter.

Selecting **Solarization** opens the Solarization dialog (Figure 154), where the degree of solarization (*Threshold value*) can be specified. Entering a value above 70% reverses the inversion effect on colors. Selecting *Invert* reverses the effect of the **Solarization** image filter.



Original Solarization
 Figure 153: Solarization image filter

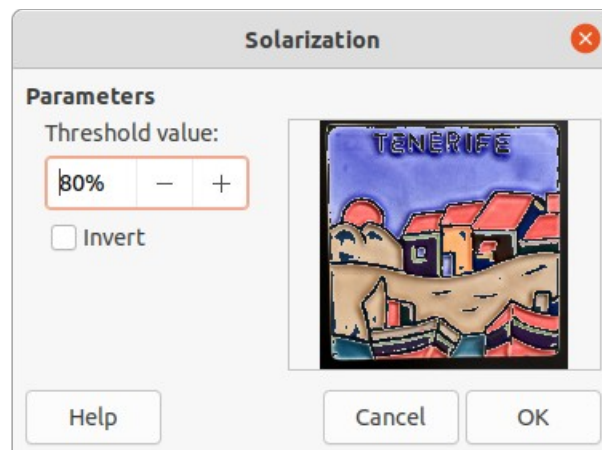

Figure 154: Solarization dialog

- **Aging** – aging creates a look that resembles photographs developed in the early days of photography (Figure 155). All pixels are set to their gray values and then the green and blue color channels are reduced by the amount specified in *Aging degree* in the Aging dialog. Red color channel is not changed.

Selecting the **Aging** filter opens the Aging dialog (Figure 156), where the *Aging degree* can be defined and create an old look for the image.



Original Aging

Figure 155: Aging image filter

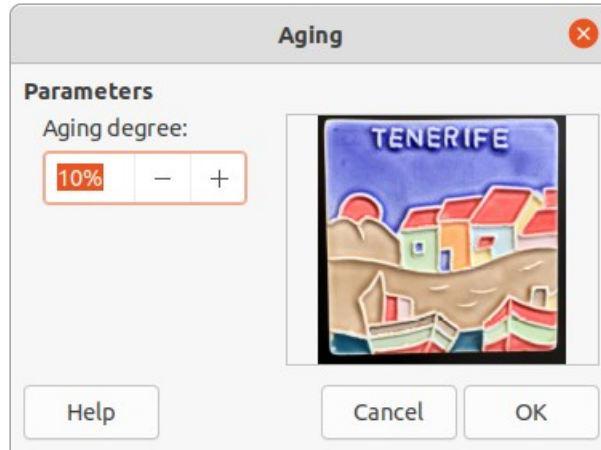

Figure 156: Aging dialog

- **Posterize** – posterizing reduces the number of colors in an image. For example, a photograph will probably look like a painting when the number of colors is reduced (Figure 157).

Selecting **Posterize** opens the Posterize dialog (Figure 158), where the number of poster colors can be defined to produce the effect required.



Original Posterize

Figure 157: Posterize image filter

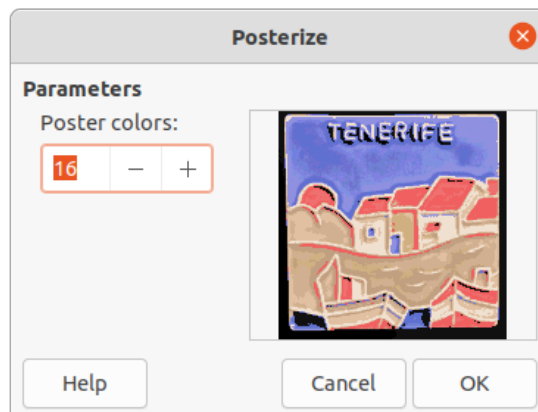

Figure 158: Posterize dialog

- **Pop Art** – changes the colors of an image converting it to a pop-art format (Figure 159).



Original Pop Art
Figure 159: Pop Art image filter

- **Charcoal Sketch** – displays an image as a charcoal sketch. The contours of the image are drawn in black and the original colors are suppressed (Figure 160).



Original Charcoal Sketch
Figure 160: Charcoal Sketch image filter

- **Relief** – calculates the edges of an image in relief as if the image is illuminated by a light source (Figure 161). Selecting **Relief** opens the Emboss dialog (Figure 162) where the position of the *Light source* is selected producing shadows that differ in direction and magnitude.



Original Relief
Figure 161: Relief image filter

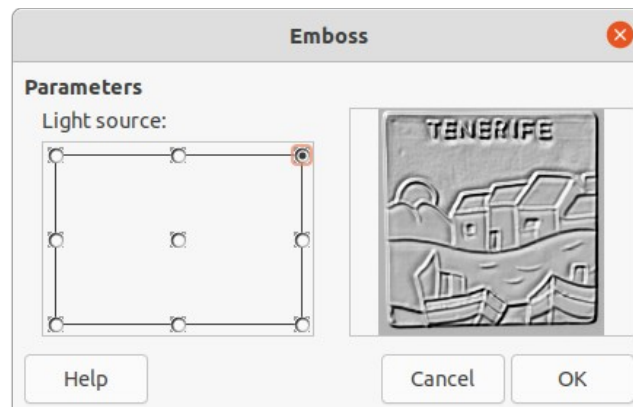

Figure 162: Emboss dialog

- **Mosaic** – this image filter joins groups of pixels and converts them into rectangles of a single color creating an image that appears to be a mosaic (Figure 163). The larger the individual rectangles created, the fewer details in the mosaic graphic.

Selecting this image filter opens the Mosaic dialog (Figure 164), where the number of pixels for *Width* and *Height* of the tiles is set. Selecting *Enhanced edges* enhances the edges of each tile, creating a sharper definition.



Original

Mosaic

Figure 163: Mosaic image filter

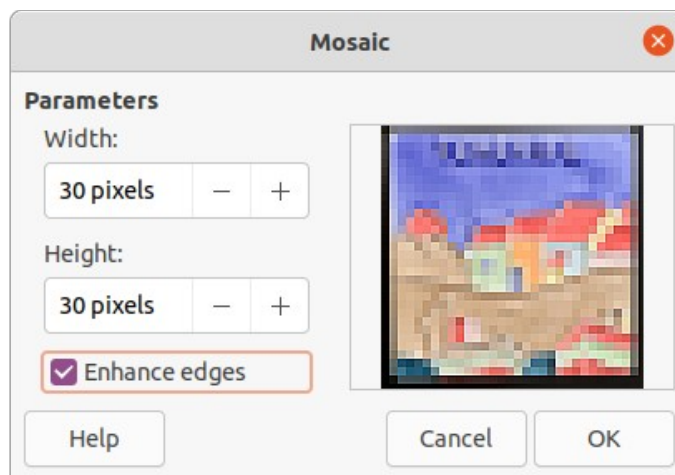

Figure 164: Mosaic dialog

Replacing colors

The **Color Replacer** tool only allows replacement or changing a color in an embedded graphic for another color or set a color as transparent. Up to four colors can be replaced at once. An area of the graphic cannot be selected for editing as this tool only works on the entire graphic.

The selection of replacement colors can only be from one of the available palettes in LibreOffice. New colors cannot be defined here, but custom colors can be created before using the **Color Replacer** tool. For more information on creating colors, see Chapter 11, Advanced Draw Techniques.

✓ Note

The **Color Replacer** can only be used on embedded graphics. If the **Color Replacer** is used on a linked graphic, the following error message appears “*This image is linked to a document. Do you want to unlink the image in order to edit it?*”. Click on **Yes** to unlink and embed the graphic.

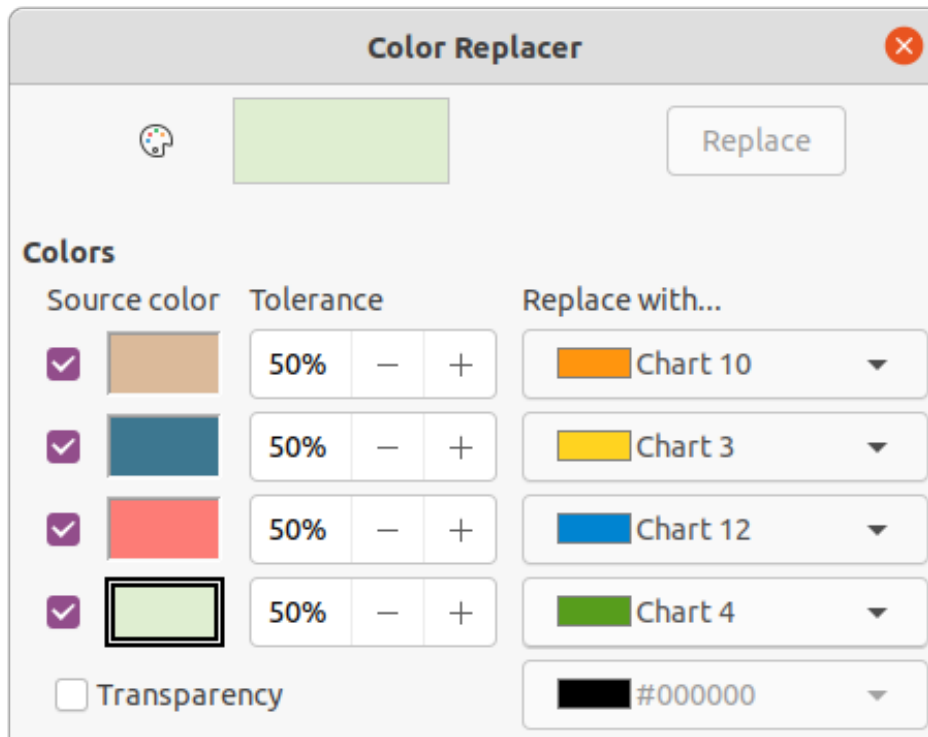

Figure 165: Color Replacer dialog

Color Replacer dialog

- **Pipette** – switches color selection on when selected.
- **Replace** – replaces the selected source colors in the selected image with the colors specified in the *Replace with* boxes.
- **Colors** – lists the source colors and the replacement colors.
 - *Source color checkbox* – select this checkbox to replace the current *Source color* with the color that specified in the *Replace with* box.
 - *Tolerance* – set the tolerance for replacing a source color in the source image. To replace colors that are similar to the color selected, enter a low value. To replace a wider range of colors, enter a higher value.
 - *Replace with* – lists the available color palettes and replacement colors.
- **Transparency** – replaces transparent areas in the selected image with the color selected.

Replacing colors

- 1) Select an embedded image to start using the Color Replacer.
- 2) Go to **Tools > Color Replacer** on the Menu bar to open the Color Replacer dialog (Figure 165).
- 3) Click on **Pipette** at the top of the Color Replacer dialog to activate the color selection mode.
- 4) Move the cursor over the color to be replaced in the selected image and a preview of the color appears in the box next to **Pipette**.
- 5) Click on the color. The selected color appears in the first *Source color* preview box and a check mark appears next to it



Figure 166: Example of using color replacer

- 6) To select another color, place a check mark next to the second *Source color* preview box and click on another color in the selected image. A maximum of four colors can be selected in the Color Replacer dialog.
- 7) Enter the amount of tolerance required for replacing each selected color in the *Tolerance* boxes. The default selection is 10% tolerance.
- 8) In *Replace with*, select a color palette from the drop-down list, then select the required color from the color palette. **Transparent** is the default selection.
- 9) After selecting up to four colors for replacement, click **Replace** to replace the colors in the selected graphic. An example of color replacement is shown in Figure 166.
- 10) There is no preview of the effect. If the result is not satisfactory, select **Edit > Undo > Color Replacer** in the Menu bar and repeat the color replacement.

✓ Note

Using the Color Replacer replaces all occurrences of the *Source color* that are in the selected image.

✓ Note

The default selection of *Transparent* in the *Replace with* boxes removes the selected color from the image and creates transparent areas in the selected image.

Replacing transparent areas

To replace any transparent areas in an image with a color use the following procedure:

- 1) Go to **Tools > Color Replacer** on the Menu bar to open the Color Replacer dialog.
- 2) Select an image with transparent areas.
- 3) Select **Transparency** in the Color Replacer dialog so that a check mark appears next to **Transparency**.
- 4) Select a color palette from the drop-down list next to **Transparency**, then select a color from the selected palette.
- 5) Click on **Replace** and the transparent areas are filled with the selected color.
- 6) There is no preview of the effect. If the result is incorrect, select **Edit > Undo > Image Color Replacer** in the Menu bar.

Conversion

Contour conversion

Contour conversion converts a selected object to a polygon, or a group of polygons, with four corner points. If an image was converted to a contour, then the converted image is set as a background graphic. If the conversion creates a group of polygons (for example, contour conversion of a text object), then enter the polygon group before selecting an individual polygon within the group. For more information on working with groups, see Chapter 5, Combining Multiple Objects.

After an object is converted to a contour, the object can no longer be edited normally. Instead, the contour converted object is edited using **Edit > Points** on the Menu bar to adjust its shape. For more information on editing points, see Chapter 3, Working with Objects.

Note

Any editing to an object must be completed before carrying out a contour conversion because any further editing is not possible on the converted object.

- 1) Carry out all necessary editing on the object before converting to a contour.
- 2) Make sure the object is selected.
- 3) Convert the object to a contour using one of the following methods:
 - Go to **Shape > Convert > To Contour** on the Menu bar.
 - Right-click on the selected object and select **Convert > To Contour** from the context menu.

Note

No confirmation dialog is provided for a contour conversion.

Polygon conversion

Polygon conversion is used to convert a selected image into a group of polygons filled with color. The image is also converted to a vector graphic and can be resized with no loss of image quality or distortion of any text.

After conversion, the graphic can be broken into groups of polygons and then split into individual polygons. Breaking and splitting allows editing or deletion of individual colors within the graphic.

Conversion options and controls

- **Number of colors** – enter the number of colors to be displayed in the converted image. LibreOffice generates a polygon for each occurrence of a color in the image. The range for the number of colors is between 8 and 32.
- **Point reduction** – removes color polygons that are smaller than the pixel value entered. The range for point reduction is between 0 and 32 pixels.
- **Fill holes** – fills the blank areas in the graphic that can be created when applying a point reduction.
- **Tile size** – enter the size of the rectangle for the background fill. The range of tile sizes is between 8 and 128 pixels.
- **Source image** – preview of the original image.
- **Vectorized image** – preview of the converted image.

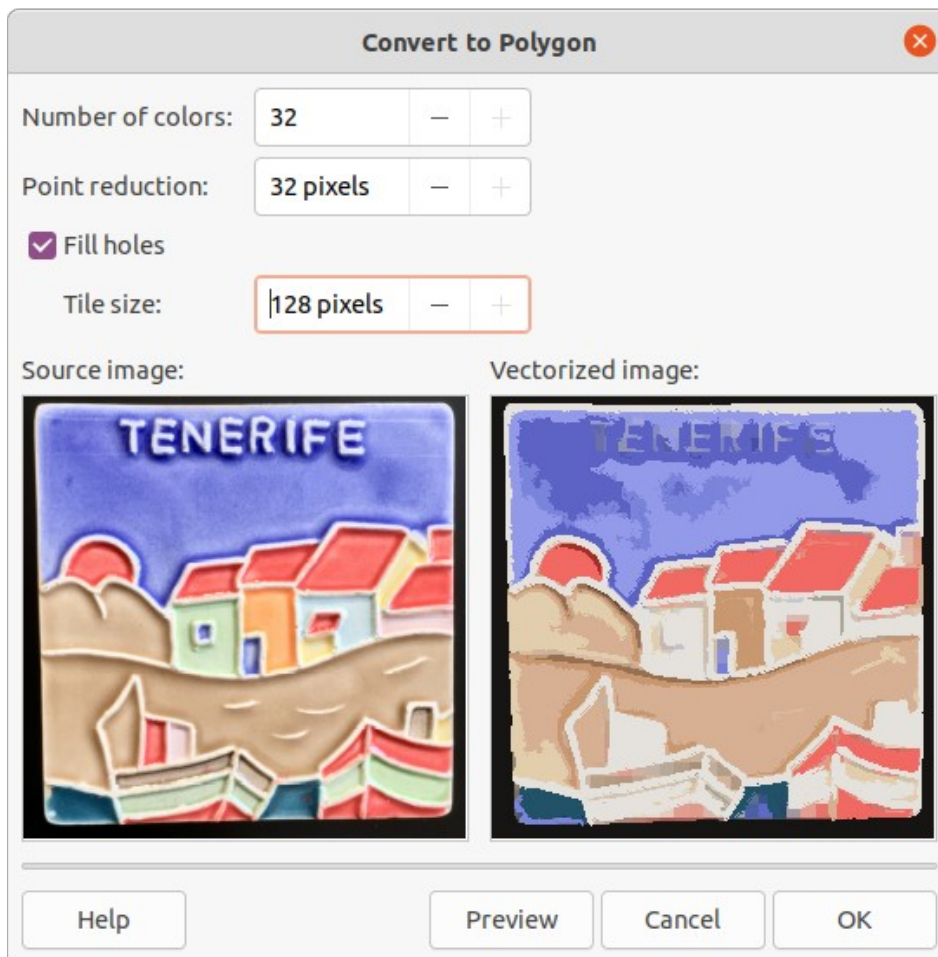

Figure 167: Convert to Polygon dialog

- **Preview** – creates a preview of the converted image in **Vectorized image** without applying any changes.
- **OK** – converts the image to a vector graphic consisting of polygons. The result is a metafile in SVM format (StarView Metafile) used by LibreOffice and allows transfer of the converted image to other LibreOffice documents.

Converting

- 1) Select an image in a drawing.
- 2) Convert the image into a polygon using one of the following methods and open the Convert to Polygon dialog (Figure 167):
 - Go to **Shape > Convert > To Polygon** on the Menu bar.
 - Right-click on the image and select **Convert > To Polygon** from the context menu.
- 3) Select Number of colors and **Point reduction** to be used in the conversion.
- 4) Select **Fill holes** to prevent any blank areas appearing in the converted image.
- 5) Enter the number of pixels to use for **Tile size**.
- 6) Click **Preview** to check how the converted graphic will look.
- 7) Make any necessary changes to the settings and check the preview again.
- 8) If the converted image meets the expected requirements, click **OK** to convert the image to a polygon and close the Convert to Polygon dialog.

✓ Note

No confirmation dialog is provided for a polygon conversion.

Breaking

After converting an image to polygons, the vectorized image can be broken into groups of polygons. Each group of polygons consists of one color and becomes an object that can be used in another drawing.

- 1) Convert an image to polygons, see “Converting” above.
- 2) Make sure the converted image is selected, then use one of the following methods to break the image into groups of polygons:
 - Go to **Shape > Break** on the Menu bar.
 - Right-click on the image and select **Break** from the context menu.
- 3) Click on a color in the image and drag the group of polygons filled with that color out of the image to create a new image.
- 4) Alternatively, press *Delete* and delete the color from the image.

Splitting

After converting an image to polygons and breaking the image into groups of polygons, these polygon groups can be split into individual polygons.

- 1) Convert an image to polygons, see “Converting” above.
- 2) Break the image into groups of polygons, see “Breaking” above.
- 3) Select the image, then use one of the following methods to split the groups of polygons into individual polygons:
 - Go to **Shape > Split** on the Menu bar.
 - Right-click on the image and select **Shapes > Split** from the context menu.
 - Use the keyboard shortcut *Ctrl+Alt+Shift+K*.
- 4) Select an individual polygon (or several polygons) in the image and drag the polygon from the image to create a new image in the drawing.
- 5) Alternatively, press *Delete* to delete the selected polygon(s) from the image.

Bitmap conversion

All drawing objects placed into a LibreOffice drawing are vector graphics and these vector graphics can be converted to a bitmap (raster graphic) in PNG format. Any transparency effects in the original vector graphic are lost during conversion even though the PNG format used by LibreOffice Draw supports transparencies.

Use one of the following methods to convert a vector graphic to a bitmap:

- Go to **Shape > Convert > To Bitmap** on the Menu bar.
- Right-click on the graphic and select **Convert > To Bitmap** from the context menu.

✓ Note

No confirmation dialog is provided for a bitmap conversion.



LibreOffice
Community



Draw Guide 7.2

Chapter 7, Working with 3D Objects

Introduction

Although Draw does not match the functionality of leading drawing or image editing programs, it is capable of producing and editing 3D drawings. In Draw, two types of 3D objects are available: 3D scenes and extruded 3D shapes. The **Status Bar** indicates when a 3D scene has been selected (Figure 168), but only indicates a shape has been selected (Figure 169) when an extruded 3D shape is selected.

Depending on which type is selected, there are different possibilities for further editing of the object (rotation, illumination, perspective, and so on). Extruded 3D shapes are simpler to set up and edit, but 3D scenes allow for greater customization.

3D objects are created using one of the following methods:

- **3D Objects** – these are ready made 3D objects and are also 3D scenes. They are selected using one of the following methods:
 - Click on **3D Objects** in the Drawing toolbar (Figure 170).
 - Select a 3D object in the **3D Objects** panel in the Shapes deck on the Sidebar (Figure 171).
- Convert a 2D object into a 3D object use one of the following tools. These tools are either available on the Drawing toolbar or by right-clicking on the object and selecting from the context menu.:
 - **To 3D** – creates a 3D scene containing an extrusion object.
 - **To 3D Rotation Object** – creates a 3D scene into a rotation object using a default rotation axis.
 - **In 3D Rotation Object** – creates a 3D scene into a rotation object using a user defined rotation axis.
 - **Toggle Extrusion** – creates a 3D shape by extruding a 2D object into 3D. Only 3D shapes that have been extruded can be converted back to a 2D object.

✓ Note

Before creating 3D objects in a drawing, it is recommended that the 3D tools are added to the Drawing toolbar (Figure 170) using **Visible Buttons** or the Customize dialog. For information on using **Visible Buttons** and the Customize dialog, see Appendix B, Toolbars and the *Getting Started Guide*.

After installing 3D tools onto the Drawing toolbar, these tools only become available when a 2D object is selected in a drawing.

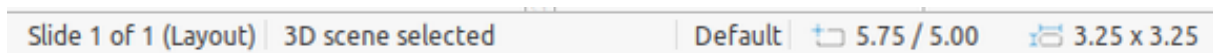

Figure 168: Status Bar showing 3D scene selected

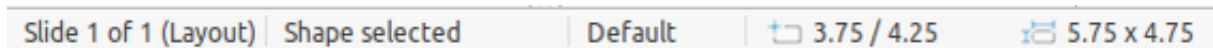

Figure 169: Status Bar showing shape selected



Figure 170: Drawing toolbar with 3D tools added

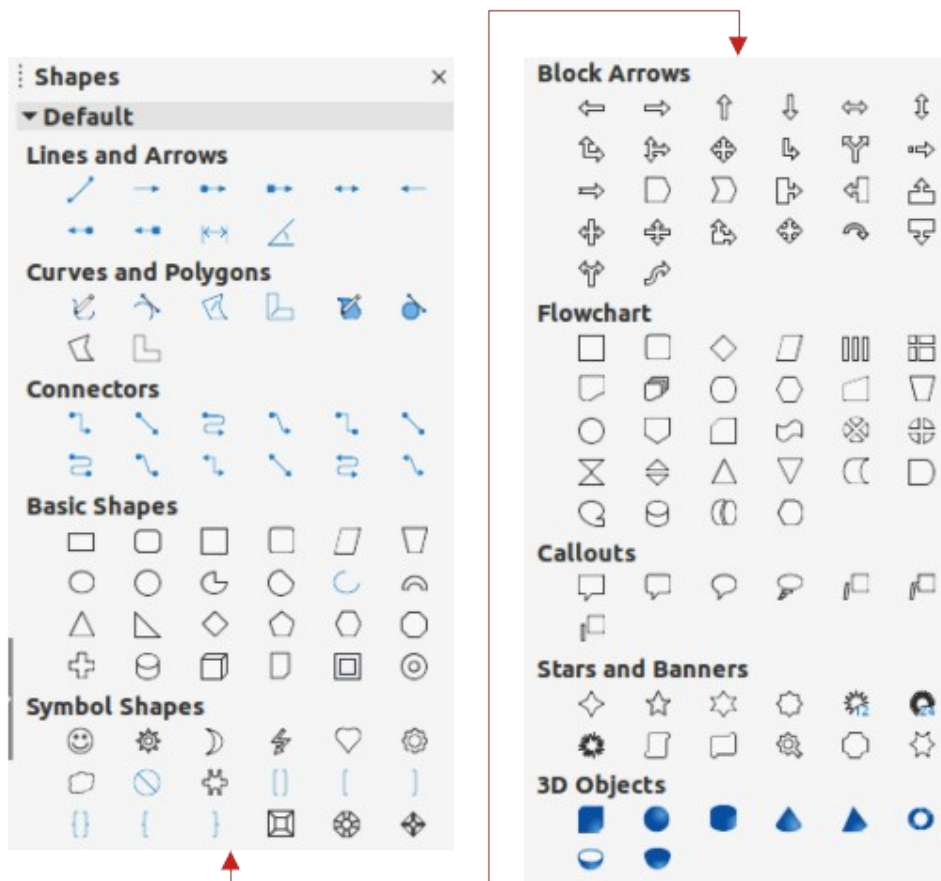

Figure 171: Shapes deck on Sidebar

3D object types

3D scenes

3D scenes are created from objects with dimensions using x, y, and z coordinates and can contain object types, such as cube, sphere, extrusion object or rotation object. These object types do not exist outside a 3D scene.

The **Status Bar** displays *3D scene selected* when a 3D object is selected that has been created from a 2D object using body rotation or conversion, or it is a ready-made 3D object that has been inserted into a drawing.

A 3D scene acts similar to a group. Just like a group, a 3D scene can be entered for editing an individual object in the 3D scene and then exit after editing is completed. See Chapter 5, Combining Multiple Objects for more information on entering, editing and exiting groups.

When a 3D scene is created from a selection of more than one 2D object, a group is automatically created as a single 3D scene. This 3D scene can be entered so that individual objects within the 3D scene can be changed, edited and rotated.

✓ Note

Individual objects cannot be ungrouped when a 3D scene has been created from a selection of 2D objects.

3D shapes

2D shapes are flat with only width and height dimensions, but 3D shapes are solid objects that have three dimensions: depth, width, and height.

A 3D shape is created when a 2D shape or an object from the Fontwork Gallery is turned into 3D using **Toggle Extrusion**. The Status Bar displays *Shape selected* when this type of 3D object is selected.

A 3D shape can be viewed and edited in 3D or 2D mode. To edit in 2D mode, switch off extrusion, make the editing changes, and switch back to 3D mode using **Toggle Extrusion**.

✓ Note

Toggle Extrusion can only be used when a 2D shape, a 3D object that has been extruded from a 2D shape, or an object from the Fontwork Gallery is selected in a drawing. It is not available for text, lines, arrows, curves, and polygons.

Creating 3D objects

3D ready made objects

3D ready made objects are 3D scenes and are inserted into a drawing using one of the following methods. The selection and drawing of 3D objects is the same for all methods of inserting a 3D ready made object.

- Click on the triangle ▼ to the right of **3D Objects** on the Drawing toolbar and select a 3D object from the sub-toolbar. The **3D Objects** icon displayed on the Drawing toolbar depends on the 3D object that had been previously selected and used.
- Go to **View > Toolbars > 3D-Objects** on the Menu bar to open the 3D-Objects toolbar (Figure 172).
- Go to **Shapes > Insert > 3D Objects** on the Menu bar and select a 3D object from the sub-menu.
- Go to the **3D Objects** panel in the Shapes deck on the Sidebar and select a 3D object.



Figure 172: 3D Objects toolbar

✓ Note

Ready made 3D objects can be repositioned, resized, and edited in the same way as 2D objects. See Chapter 3, Working with Objects for more information.

Extrusion

Extrusion converts a 2D object into a 3D scene by extruding the 2D object toward the observer. The scene is rotated by 20 degrees around the horizontal axis to make the 3D effect more visible. Examples of 3D conversion using extrusion are shown in Figure 173. After selecting a 2D object, convert it to a 3D scene using one of the following methods:

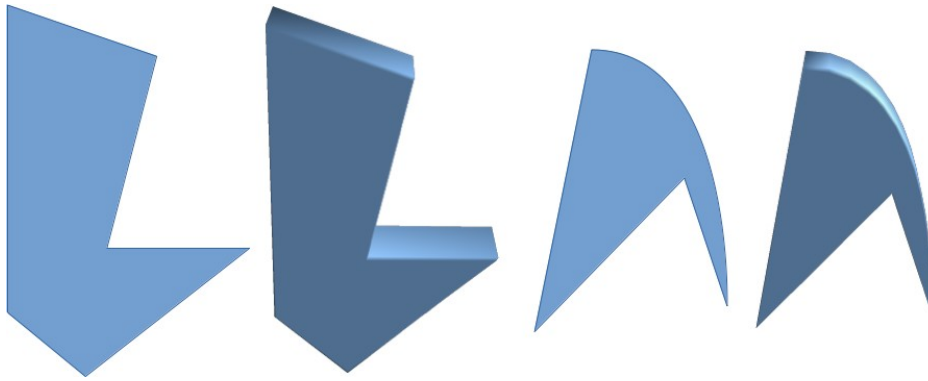

Figure 173: Example of using extrusion for 3D conversion

- Right-click on the 2D object and select **Convert > To 3D** from the context menu.
- Click on **To 3D** in the Drawing toolbar.
- Go to **Shape > Convert > To 3D** on the Menu bar.
- Click on **Convert to 3D** in the 3D Effects dialog (Figure 179 on page 156).

Rotation

To 3D Rotation Object and Convert to Rotation Object

To 3D Rotation Object or **Convert to Rotation Object** converts a 2D object into a 3D scene by rotating the object using the left edge of the bounding box around the object as the axis of rotation. Examples of 3D conversion using either of these rotation tools are shown in Figure 174. The actual 3D scene created depends on the angle and shape of the object being rotated.

After selecting a 2D object in a drawing, convert it to a 3D scene using rotation with one of the following methods:

- Right-click on a 2D object and select **Convert > To 3D Rotation Object** from the context menu.
- Click on **To 3D Rotation Object** in the Drawing toolbar.
- Go to **Shape > Convert > To 3D Rotation Object** on the Menu bar.
- Click on **Convert To Rotation Object** in the 3D Effects dialog.

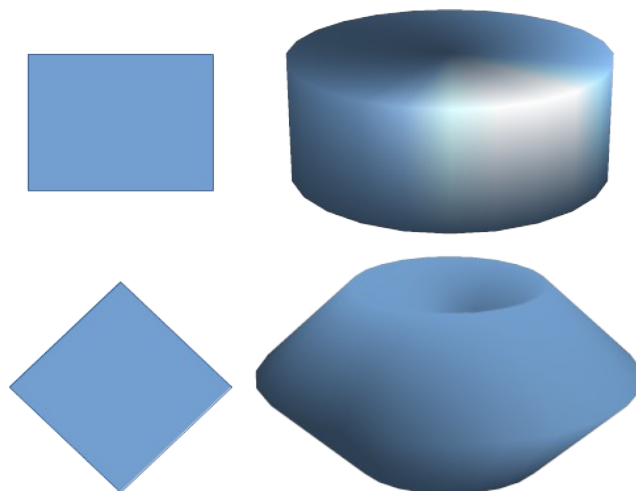

Figure 174: Examples of using rotation for 3D conversion

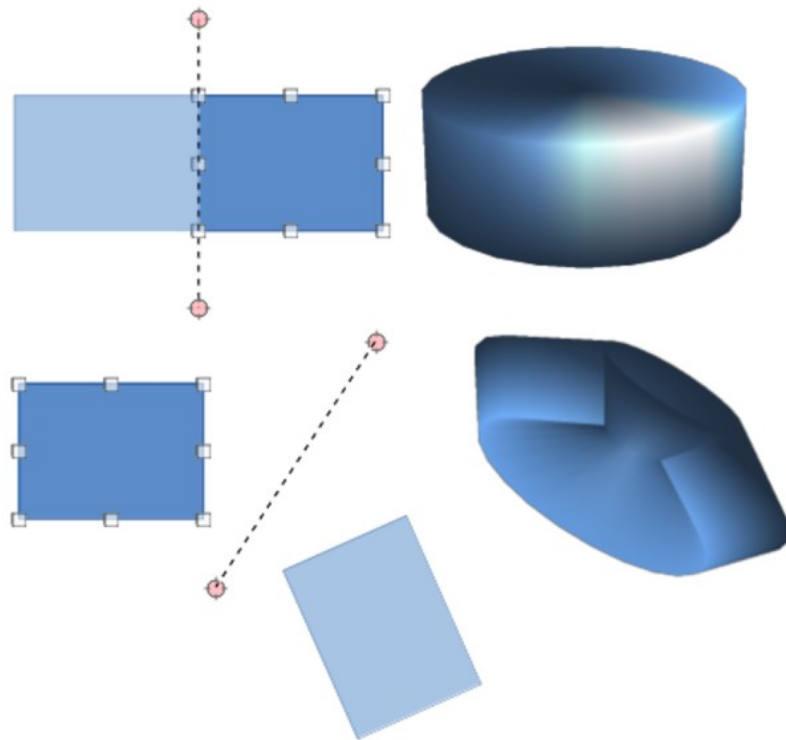

Figure 175: Example of moving rotation axis using In 3D Rotation Object

In 3D Rotation Object

In 3D Rotation Object converts a 2D object into a 3D scene by rotating the object through a movable axis of rotation. An example of moving the rotation axis and changing the rotation angle is shown in Figure 175. The actual 3D scene created also depends on the angle and shape of the object being rotated.

- 1) Select a 2D object in a drawing.
- 2) Click on **In 3D Rotation Object** in the Drawing toolbar.
- 3) Adjust the position and angle of the rotation axis. This is shown as a dashed line with rotation points at each end.
- 4) Click anywhere outside the 2D object and it is converted into a 3D scene, as shown in Figure 175.

Toggle Extrusion

Extrusion is where parallel surfaces are moved to create a 3D shape. In Draw, the 2D surface is moved forwards out of the drawing level. At the same time the object is slightly tilted and central projection turned on, creating the impression of a 3D shape. Draw uses a default value for this extrusion (body depth) based on the size of the 2D object. The value can be changed after the extrusion, see "Editing 3D objects" below.

Extrusion conversion is carried out using **Toggle Extrusion**. Extrusion only works on basic shapes, symbol shapes, block arrows, flowcharts, callouts, and stars and banners that are included as a part of the default set of tools on the Drawing toolbar or in the Shapes deck on the Sidebar. Extrusion can also be used on any objects created using Fontwork. Examples of toggle extrusion are shown in Figure 176.

- 1) Select a 2D object in a drawing that has been created from basic shapes, symbol shapes, block arrows, flowcharts, callouts, or stars and banners.



Figure 176: Examples of toggle extrusion

- 2) Click on **Toggle Extrusion** on the Drawing toolbar to convert the 2D object into a 3D shape.
- 3) To convert a 3D conversion back into a 2D object, select the 3D object and click on **Toggle Extrusion** on the Drawing toolbar.

✓ Note

Extrusion cannot be used on text objects created using **Insert Text Box** or **Insert Vertical Text**.

Editing 3D objects

✓ Note

Where 3D scenes have been created from more than one 2D object, a 3D scene group is automatically created. This 3D scene group cannot be ungrouped and any editing carried out will affect all 3D objects within the group. To edit an individual 3D object within this 3D scene group, enter the group. See Chapter 5, Combining Multiple Objects more information on working with groups.

Position, Size and Rotation

Editing the position, size and rotation of 3D objects is similar to 2D objects. See Chapter 3, Working with Objects for more information.

3D settings

To open the 3D-Settings toolbar (Figure 177), go to **View > Toolbars > 3D-Settings** on the Menu bar. The 3D-Settings toolbar only becomes active when a 3D shape is selected that has been created from a 2D object using “Toggle Extrusion” above.

The tools available for editing 3D shapes are as follows. The result of any changes made using these editing tools is applied to the selected 3D shape immediately displaying the effect of the 3D setting applied. Figure 178 shows an example of tilting left, increasing extrusion depth, and changing 3D color using the 3D-Settings toolbar.

- **Tilt Down** – tilts the selected object downward (horizontal axis rotation) by 5 degrees each time the icon is used.
- **Tilt Up** – tilts the selected object upward (horizontal axis rotation) by 5 degrees each time the icon is used.

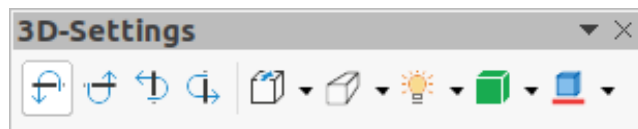

Figure 177: 3D Settings toolbar

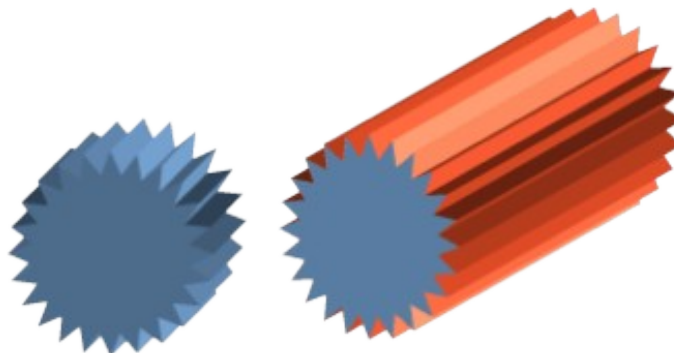

Figure 178: Example of changing 3D settings

- **Tilt Left** – tilts the selected object left (vertical axis rotation) by 5 degrees each time the icon is used.
- **Tilt Right** – tilts the selected object right (vertical axis rotation) by 5 degrees each time the icon is used.
- **Depth** – opens a pop-up menu where where the extrusion depth can be set from an object by a fixed or custom amount.
- **Direction** – opens a pop-up menu where the view direction can be set to create an extrusion in either a perspective or parallel projection.
- **Lighting** – opens a pop-up menu where the direction and intensity of the lighting can be set when creating an extrusion.
- **Surface** – opens a pop-up menu where the surface of the extrusion can be set as matt, or wireframe display.
- **3D Color** – opens a pop-up menu where the color used for the extrusion can be set. This color does not have to be the same as the color used for the original 2D object.

✓ Note

The 3D Effects dialog cannot be used on 3D shapes created using Toggle Extrusion because the correct formatting results will not be achieved. If the 3D Effects dialog is used in error, remove any incorrect formatting by going to **Format > Default Formatting** on the Menu bar.

3D effects

The 3D Effects dialog (Figure 179) offers a wide range of possible settings for editing 3D ready made objects or 3D scenes. This dialog can also be used to convert a 2D object to 3D using the tools in the bottom left corner of the dialog. To open the 3D Effects dialog, click on **3D Effects** on the Line and Filling toolbar, or go to **Format > 3D-Effects** on the Menu bar.

Any 3D effects applied to a 3D scene are not carried out until **Assign** is clicked in the top right of the 3D Effects dialog. This allows for all 3D effect changes to be carried out before applying them to a 3D scene.

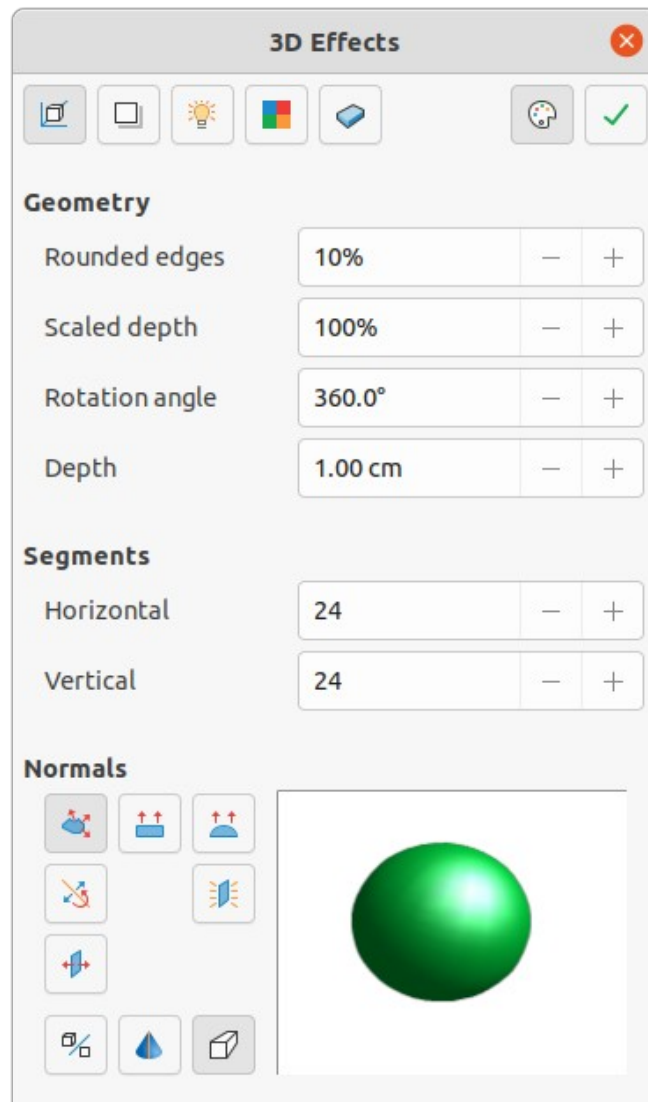

Figure 179: 3D Effects dialog - Geometry page

Note

Any options on the pages in the 3D Effects dialog that are grayed out cannot be used for the selected object.

3D conversion

In the bottom left corner of the 3D Effects dialog are tools for converting a 2D object into a 3D scene and changing the projection used in a 3D scene.

- **Convert to 3D** – converts the selected object into a 3D scene. This tool works in the same way as using “Extrusion” on page 151.
- **Convert to Rotation Object** – converts a 2D object into a 3D scene using body rotation. This tool works in the same way as using “Rotation” on page 152.
- **Perspective On/Off** – switches perspective projection on or off for a 3D scene. Perspective projection is a technique to create a linear illusion of depth. As objects get further away from the viewer, a perspective drawing decreases in size at a constant rate.

3D Effects – Geometry

Click on **Geometry** in the 3D Effects dialog (Figure 179) to open the Geometry page and use the options available to change the geometry of a 3D object.

- **Geometry** – defines the properties of an object in a 3D scene.
 - *Rounded edges* – enter the amount required to round the corners of a 3D shape as shown by the example in Figure 180. The default setting for rounded edges is 10%.
 - *Scaled depth* – enter the amount required to increase or decrease the frontal area of a selected 3D object. Figure 181 shows an example where the scaled depth has been increased to 150% and then decreased to 50%. The default setting for scaled depth is 100%.

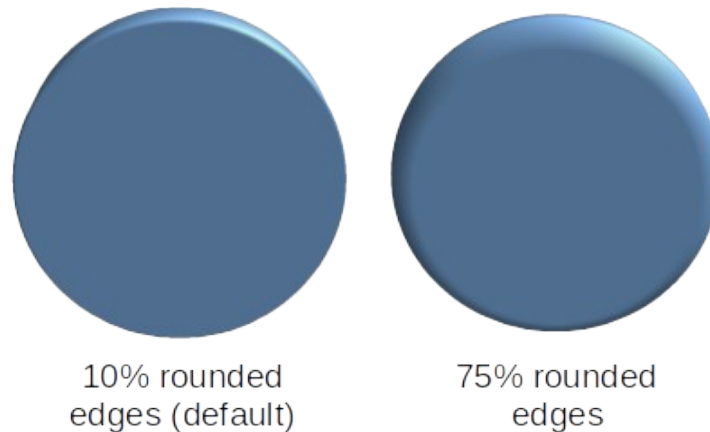

Figure 180: Example of rounded edges

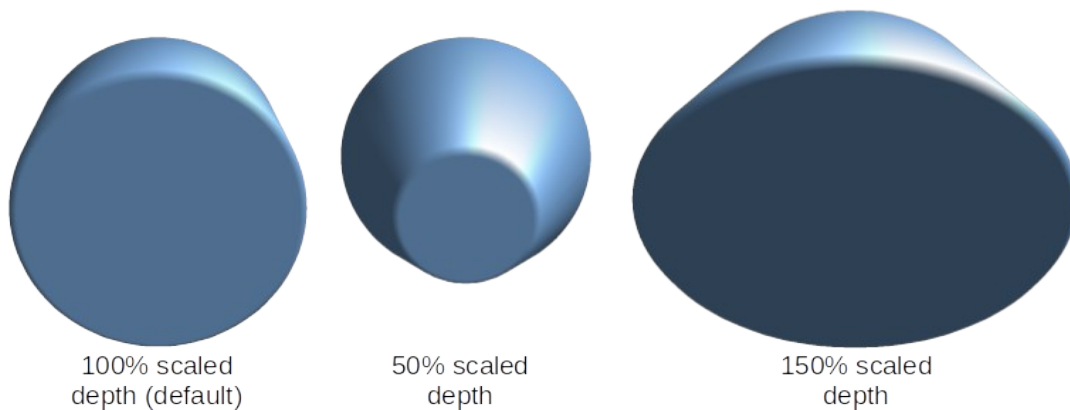

Figure 181: Example of changing scaled depth

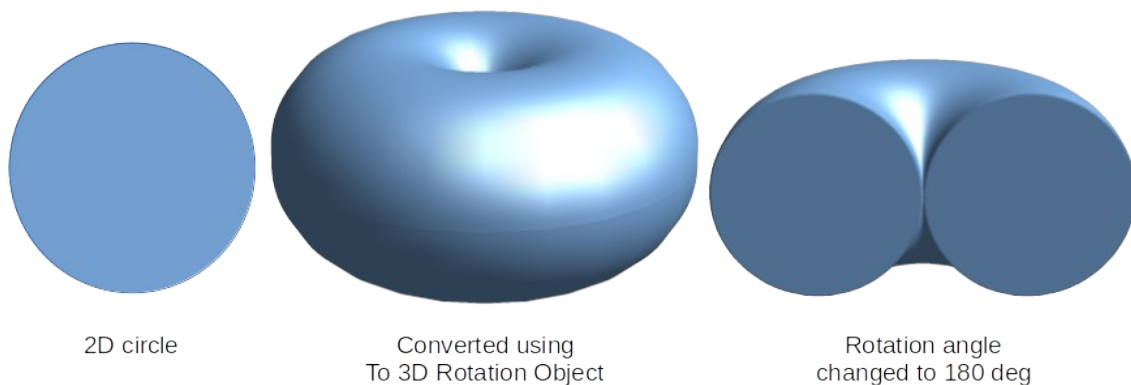

Figure 182: Example of changing rotation angle

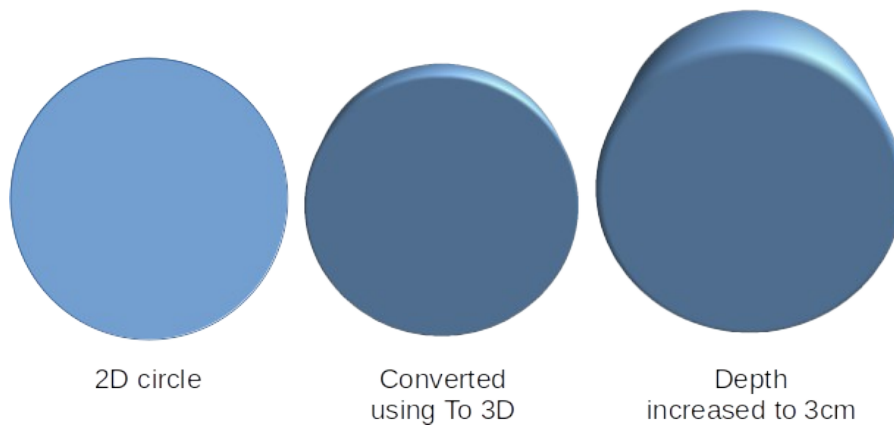

Figure 183: Example of increasing depth

- *Rotation angle* – enter the angle in degrees to rotate a 2D object that has been converted to 3D using **To 3D Rotation Object**. Figure 182 shows an example of a 2D circle where the rotation angle is changed to 150 degrees.
- *Depth* – enter the extrusion depth for the selected 2D object that has been converted to 3D using **To 3D**. Figure 183 shows an example of a 2D circle converted to a 3D cylinder with the extrusion depth increased to 3 cm.
- **Segments** – changes the number of segments that Draw uses to draw a 3D rotation object. The higher the number of segments, the smoother the object surface will be. However, a high segment number may increase the time it takes to generate the 3D object on a display. Figure 184 shows the difference on a 3D sphere when the segments have been increased from 10 to 30 segments horizontally and vertically.
 - *Horizontal* – enter the number of horizontal segments used in the selected 3D rotation object.
 - *Vertical* – enter the number of vertical segments used in the selected 3D rotation object.
- **Normals** – modifies the rendering style of the 3D surface (Figure 185 and Figure 186).
 - *Object-Specific* – renders the 3D surface according to the shape of the object. For example, a circular shape is rendered with a spherical surface.
 - *Flat* – renders the 3D surface as polygons.
 - *Spherical* – renders a smooth 3D surface regardless of the shape of the object.
 - *Invert Normals* – an inverted normal is a normal that is pointing in the wrong direction. This tells a computer that an outside face is actually an inside face when it is not. If there is a hollow design, an inverted normal can be indicated because both surfaces facing are in and out in the same model.

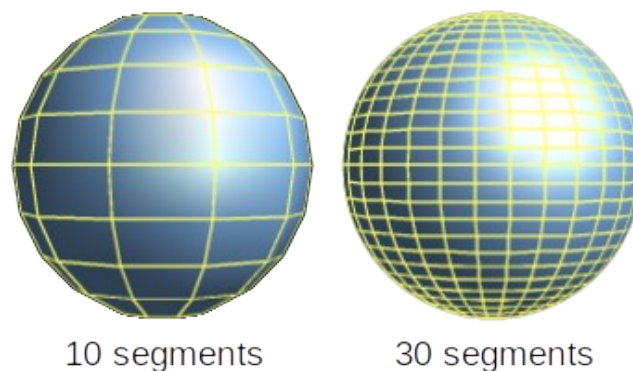

Figure 184: Example of segments

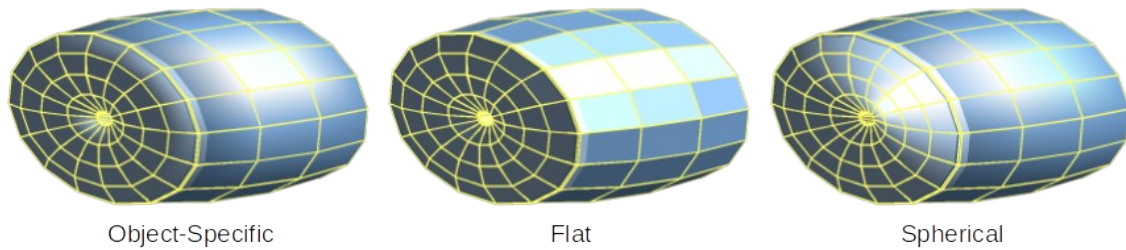

Figure 185: Examples of object specific, flat and spherical effects

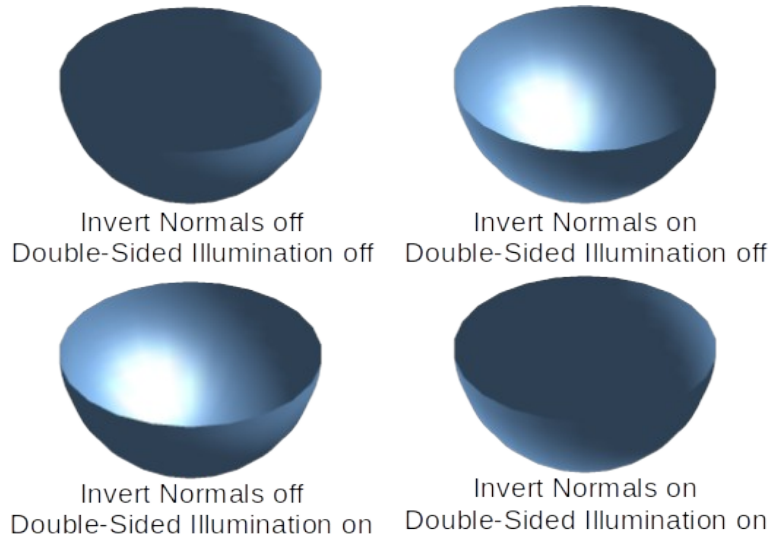

Figure 186: Examples of invert normals and double sided illumination

- *Double-Sided Illumination* – lights the outside and the inside of the object. This has only an effect, if the inside is drawn at all, see *Double-Sided*. This is a setting for the whole of the 3D scene and not for a single object within the scene.

✓ Note

Figure 186 demonstrates the 3D effect of using *Invert Normals* in conjunction with using the 3D effect *Double-Sided Illumination*.

- *Double-Sided* – a 3D object has outside (front) and inside (back) faces. With *Double-Sided* switched off, only the outside face of the object is rendered. The effect, when looking from outside, is that the object is solid, but, when looking from inside, the front face is transparent. If there is no view to the inside face, normal for an extruded 3D object with solid texture, *Double-Sided* should be switched off to improve performance during rendering. Any 3D object created using rotation often allows an inside view and it is recommended that *Double-Sided* is switched on.

3D Effects – Shading

On the **Shading** page of the 3D Effects dialog (Figure 187) provides options to set the shading, shadow, and camera effects on a selected 3D object.

- **Shading** – specifies the mode of shading applied to a 3D object (Figure 188).
 - *Gouraud* – this shading mode is a method used in computer graphics to simulate the differing effects of light and color across the surface of an object. In practice, it is used to achieve smooth lighting on low-polygon surfaces without the heavy computational requirements of calculating lighting for each pixel.

- *Phong* – this shading mode is an interpolation technique for surface shading calculating the normal of a point in the polygon by interpolating the normals of the vertices. The angle between normal and lighting direction determines how much of the lighting is used to color the pixel.
- *Flat* – this shading mode refers to the depiction of depth perception in 3D models or illustrations by varying the level of darkness. It assigns a single color of shading to a single segment on the surface of the object.

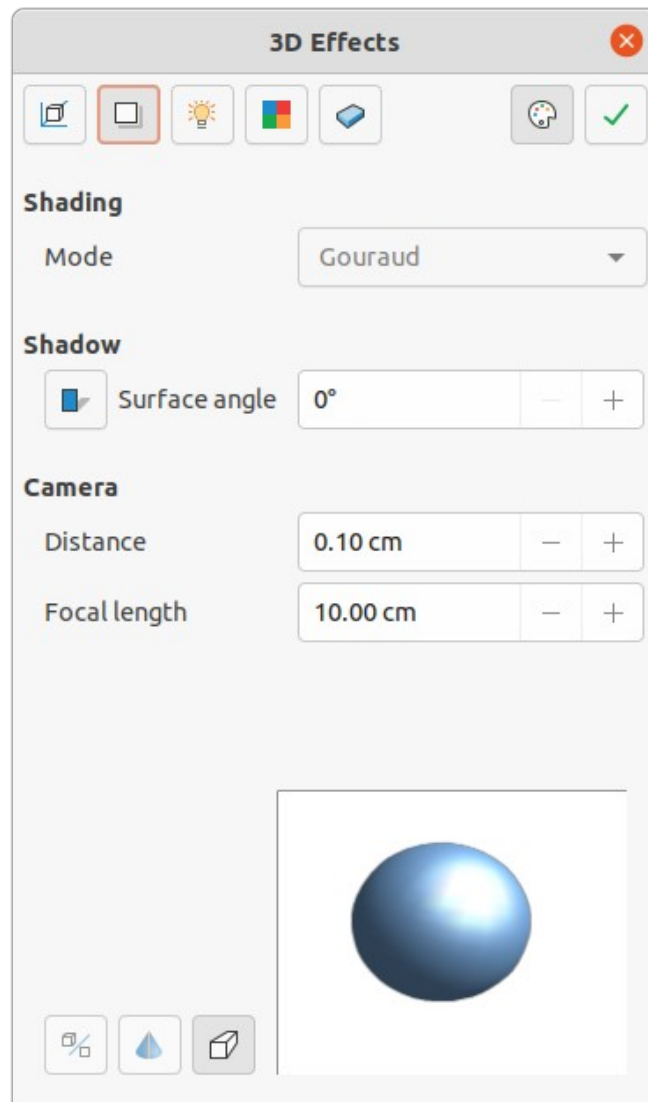

Figure 187: 3D Effects dialog - Shading page

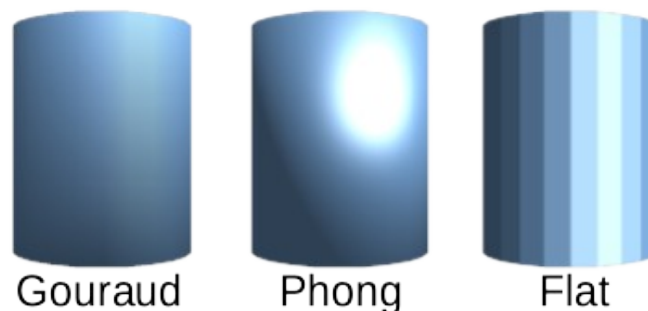

Figure 188: Examples of shading mode

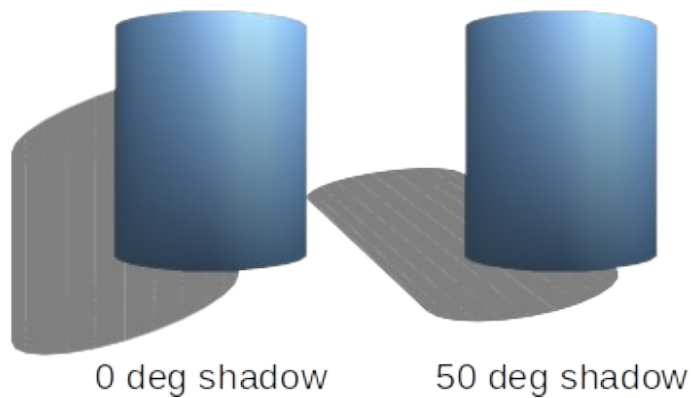

Figure 189: Examples of shadow surface angle

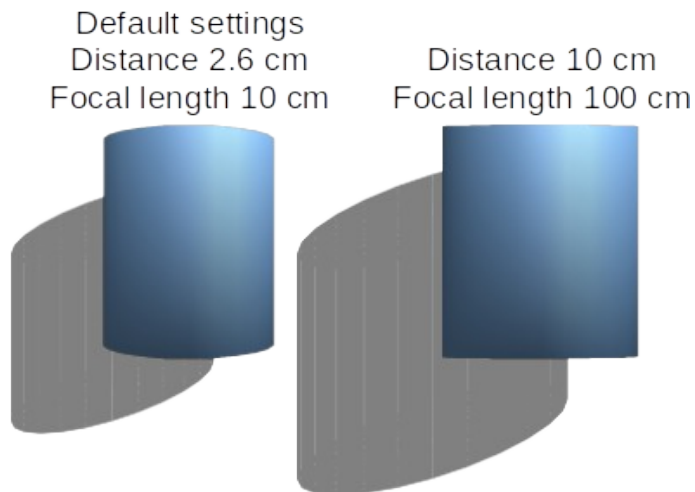

Figure 190: Example of changing camera settings

- **Shadow** – adds or removes a shadow from a selected 3D object (Figure 189). A shadow is generated only from the first light source. Enter a *Surface Angle* from the light source to the surface between 0 to 90 degrees to cast a shadow.
- **Camera** – sets the camera options for a selected 3D scene as if a camera is being used to take a photograph (Figure 190). The settings affect only central perspective and not parallel projection.
 - *Distance* – enter the distance to leave between the camera and the center of the selected 3D scene. The default setting for distance is 2.6cm.
 - *Focal length* – enter the focal length of the camera lens, where a small value corresponds to a fish-eye lens and a large value to a telephoto lens. The default setting for focal length is 10cm.

3D Effects – Illumination

The **Illumination** page of the 3D Effects dialog (Figure 191) defines how a 3D scene is lit and the settings apply to all 3D objects in a scene. The direction of the light source, color of the light source, and the ambient light can be specified for the 3D scene.

By default, one light source is already selected when the Illumination page is opened. More light sources can be selected for illumination. A maximum of eight sources can be used and each light source can use a different color. Figure 191 shows three light sources selected with each light source having a different color.

- 1) Select a *Light source* to turn the light source on. The icon changes to an illuminated bulb.
- 2) Click again on the selected light source to adjust the color for the light source.

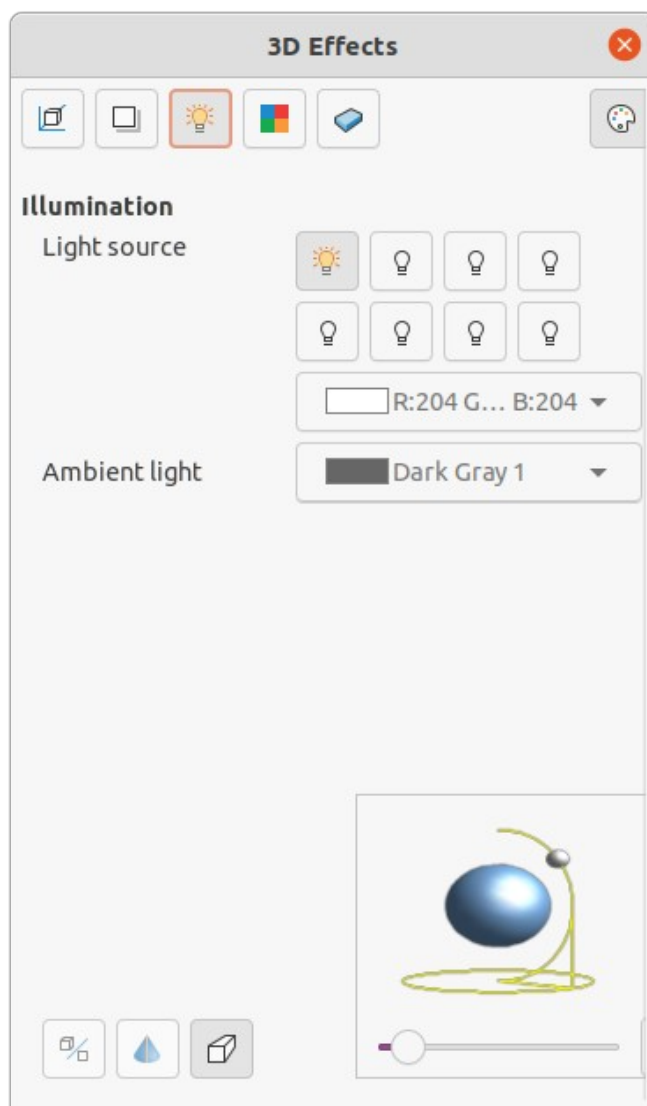

Figure 191: 3D Effects dialog - Illumination page

- 3) Select a color for the light from one of the color palettes in the *Light source* drop-down list. A different color can be used for each light source selected.
- 4) Select a color from one of the color palettes in the *Ambient light* drop-down list to set the color of the surrounding light.
- 5) To deselect a light source, select a light source already selected and click on it again.

The light source location and color are shown in the lower right corner of the Illumination page. The vertical slider bar adjusts the lighting angle and the horizontal slider bar rotates the light about the object. Alternatively, click on the light point and drag the light source to the required position.

To change the preview from a sphere to a cube, click on the small square to the right of the horizontal slider bar and below the vertical slider bar.

Each light source selected is shown as a small colored sphere in the color specified for it. The larger colored sphere indicates the active light source.

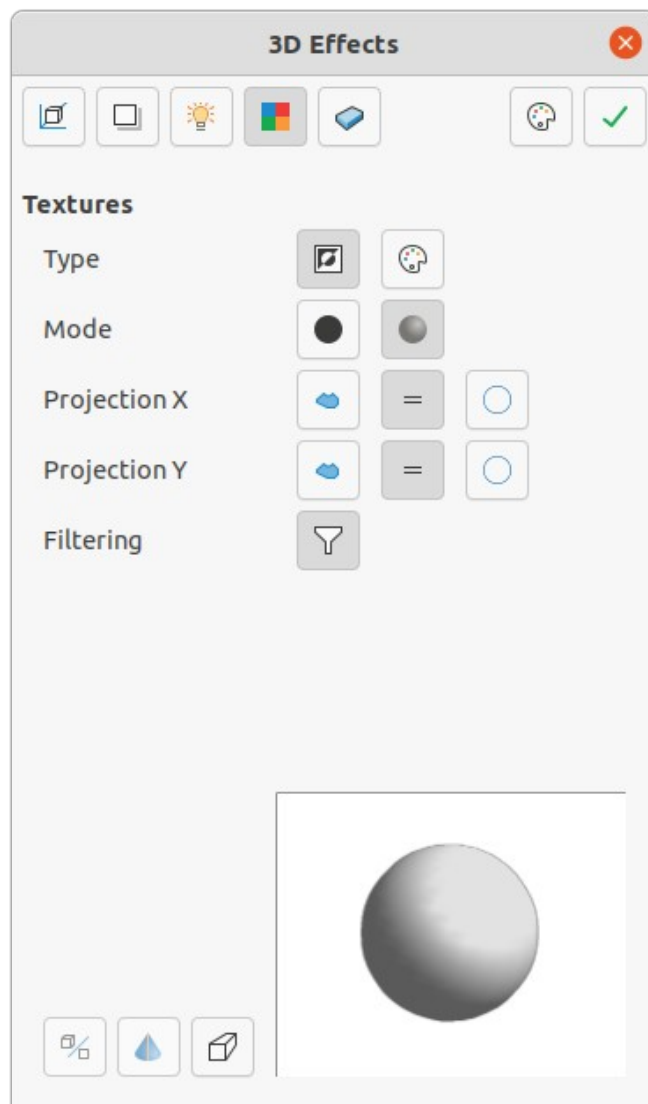

Figure 192: 3D Effects dialog- Textures page

3D Effects – Textures

On the **Textures** page of the 3D Effects dialog (Figure 192) the properties of the surface texture can be set for a selected 3D object. **Textures** is only available after the area fill of a 3D object is set to *Gradient*, *Hatching*, or *Bitmap*. For more information on changing area fill, see Chapter 4, Changing Object Attributes.

- **Type** – sets the color properties of the texture.
 - *Black & White* – converts the texture to black and white.
 - *Color* – converts the texture to color.
- **Mode** – shows or hides shading.
 - *Only Texture* – applies the texture without shading.
 - *Texture and Shading* – applies the texture with shading. To define the shading options for the texture, see “3D Effects – Shading” above.
 - *Texture, Shadow and Color* – applies the texture with a shadow and color. To define the shading options for the texture, see “3D Effects – Shading” above.
- **Projection X** – sets the options for displaying the texture along the X axis. Only one of the three following options can be selected.

- *Object-Specific* – automatically adjusts the texture for best fit based on the shape and size of the object. This is the default setting except for extrusion objects.
- *Parallel* – applies the texture parallel to the horizontal axis and is mirrored on the rear side of the object. This is the default setting for extrusion objects.
- *Circular* – wraps the horizontal axis of the texture pattern around an object.
- **Projection Y** – sets the options for displaying the texture along the Y axis. Only one of the three following options can be selected.
 - *Object-Specific* – automatically adjusts the texture for best fit based on the shape and size of the object. This is the default setting except for extrusion objects.
 - *Parallel* – applies the texture parallel to the vertical axis and is mirrored on the rear side of the object. This is the default setting for extrusion objects.
 - *Circular* – wraps the vertical axis of the texture pattern around an object.
- **Filtering** – filters out noise that can occur when a texture is applied to a 3D object.
 - *Filtering On/Off* – applies a soft focus filter blurring the texture slightly to remove unwanted speckles.

3D Effects – Material

On the **Materials** page of the 3D Effects dialog (Figure 193) the appearance of a 3D object can be changed to represent different materials. Materials and textures can be combined with each other and it is a matter of trial and error to achieve the desired result.

- **Material** – assigns a color from a color palette. For custom colors, see Chapter 11, *Advanced Draw Techniques* for more information on creating custom colors.
 - *Favorites* – select a material type for the selected object from the *Favorites* drop-down list.
 - *Object color* – select a color from one of the color palettes in the *Object color* drop-down list.
 - *Illumination color* – select a color from one of the color palettes in the *Illumination color* drop-down list. This illuminates the object and brightens parts of the object which lie in shadow making the object seem more illuminated.
- **Specular** – sets the light reflection properties for the selected object simulating the reflecting capacity of the surface. The position of the illuminated point is determined by the setting of the first light source.
 - *Color* – select a color to be reflected from the object from one of the color palettes in the *Color* drop-down list.
 - *Intensity* – enter the intensity of the specular effect as a percentage.
- **Colors Dialog** – opens the Pick a Color dialog where custom colors are defined using the two-dimensional graphic and numerical gradient chart. Any colors created are stored in the custom palette. See Chapter 11, *Advanced Draw Techniques* for more information on creating custom colors.

Note

Metallic and glass surfaces do not simulate well because the appearance of these materials is produced using reflection.

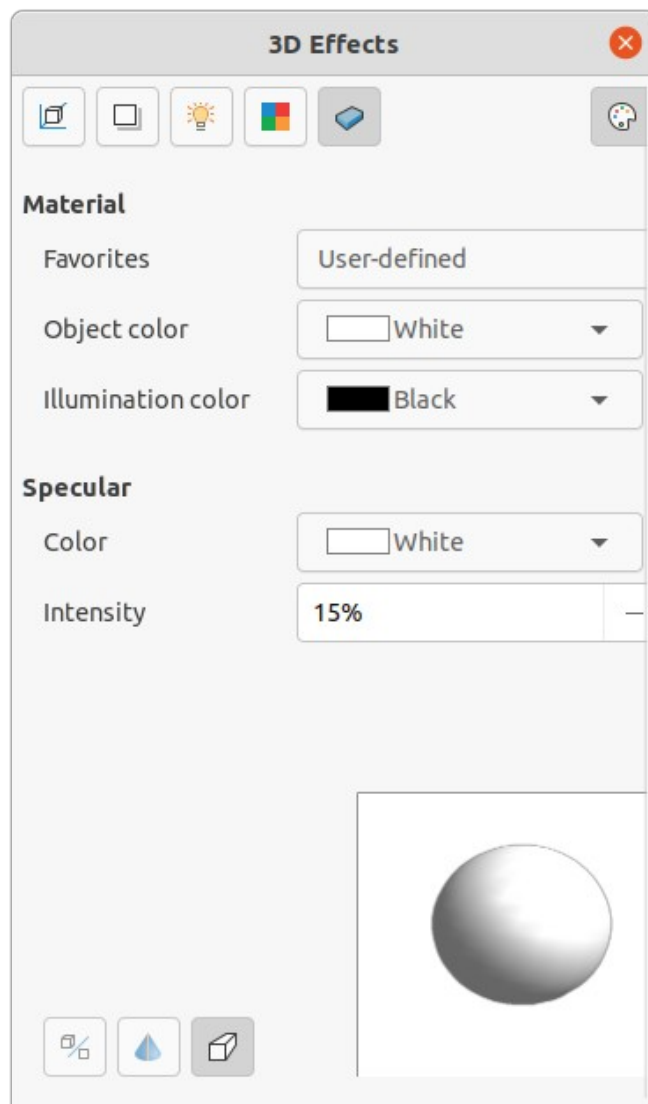

Figure 193: 3D Effects dialog - Material page

i Tip

Do not use a very high brightness value for individual colors. Colors are additive and it is easy to end up with a colored area that is white.

Combining objects

Multiple 3D objects cannot be combined using **Shape > Combine** on the Menu bar or the keyboard shortcut *Shift+Ctrl+K*. Multiple 2D objects have to be created first, then a single 3D object created as follows (see Chapter 5, Combining Multiple Objects for more information on combining objects):

- 1) Create multiple 2D objects and carry out all the necessary editing changes.
- 2) Make sure that all 2D objects are selected to create a single 3D object.
- 3) Create a single 3D object combining the multiple 2D objects using one of the following methods (example conversions are shown in Figure 194):
 - Click on **To 3D** or **To 3D Rotation Object** on the Drawing toolbar.

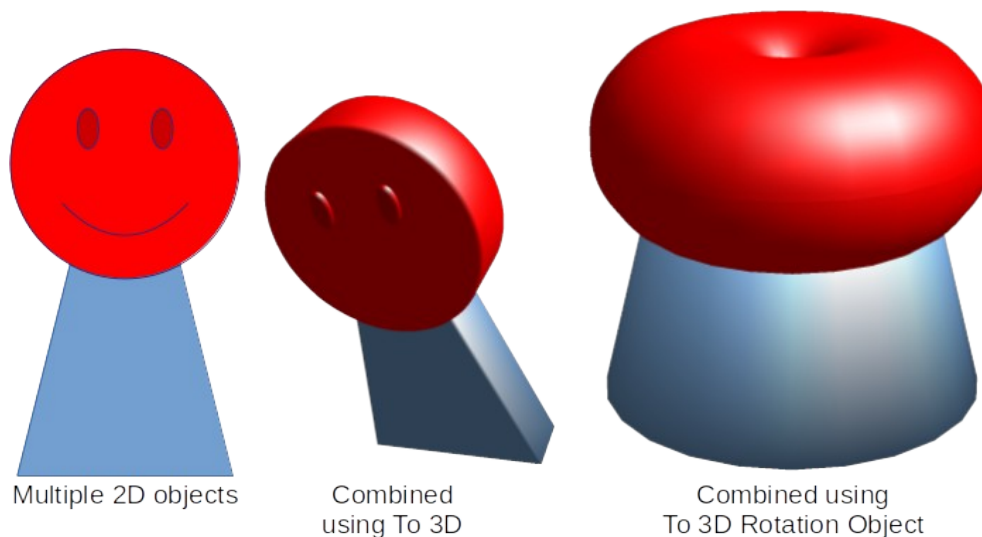

Figure 194: Example of creating single 3D object from multiple 2D objects

- Right-click on the selected multiple 2D objects and select **Convert > To 3D** or **To 3D Rotation Object** from the context menu.
- Go to **Shape > Convert > To 3D** or **To 3D Rotation Object** on the Menu bar.

Assembling 3D objects

3D objects that each form a separate 3D scene can be combined or assembled into a single 3D scene. An example procedure for assembling 3D objects is as follows and shown in Figure 195:

- 1) Select a 3D object (for example, a cube) from **3D Objects** on the Drawing toolbar or Shapes deck on the Sidebar and place it in a drawing.
- 2) Select a second 3D object (for example, a sphere) from **3D Objects** on the Drawing toolbar or Shapes deck on the Sidebar and place it in the drawing.
- 3) If necessary, set the area fill to **None** and the lines to **Continuous** to create wire frame objects. This makes it easier to position both objects in the assembled 3D scene.
- 4) Select the second 3D object (sphere) and go to **Edit > Cut** on the Menu bar or right-click on the object and select **Cut** from the context menu.
- 5) Double-click the first 3D object (cube) to enter the group or go **Shape > Group > Enter Group** on the Menu bar.
- 6) Go to **Edit > Paste** on the Menu bar or right-click on the first 3D object and select **Paste** from the context menu. The sphere now appears inside the cube and is now part of the same group.
- 7) If required, edit the individual objects or change their position within the group.
- 8) Double-click outside the 3D assembled scene to exit the group, or go to **Shape > Group > Exit Group** on the Menu bar.

✓ Note

The second object also reappears in its original position when **Paste** is carried out. This object is NOT part of the assembled 3D scene and can be deleted if necessary.

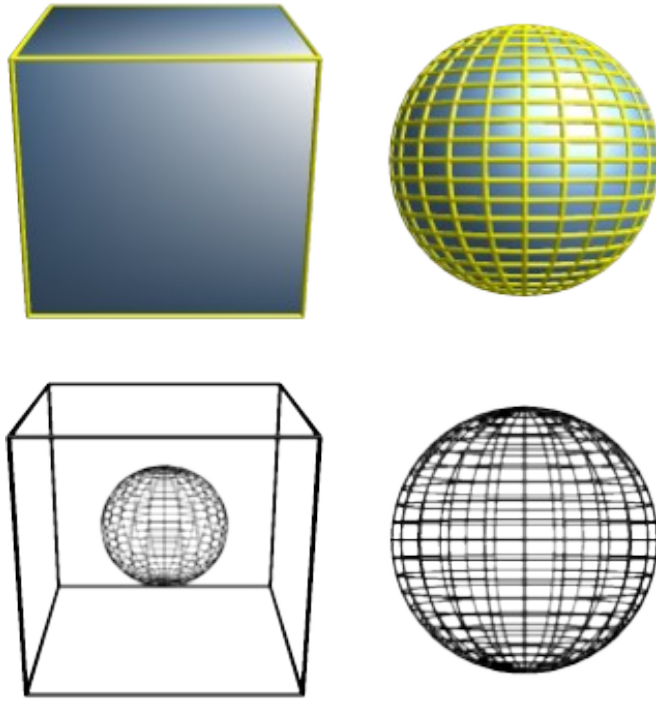

Figure 195: Example of assembling 3D objects



LibreOffice
Community



Draw Guide 7.2

Chapter 8, Connections, Flowcharts, and Organization Charts

Connectors and glue points

Connectors and glue points were briefly introduced in Chapter 2, Drawing Basic Shapes. This section describes them in more detail and how to use them.

Connectors are lines or arrows whose ends automatically dock to a connection or glue point on the border of an object. Connectors are useful in drawings because connecting lines between objects remain connected to objects, even when objects are moved or rearranged. Also, when an object with a connector attached is moved or resized, the connector automatically adjusts its shape to accommodate the changes.

For example, when creating flowcharts, organization chart, schematics, or diagrams, it is highly recommended to use connectors instead of simple lines. Using connectors removes the need to redraw lines between objects,

When a connector is drawn or selected, Draw displays selection handles that are different to the selection handles for normal lines or objects. The termination points of a connector are round at the start and end points of a connector, and square in the center of the lines that make up a connector, as shown by the example in Figure 196. The square selection handles on a connector are used to change the routing of a connector where applicable.

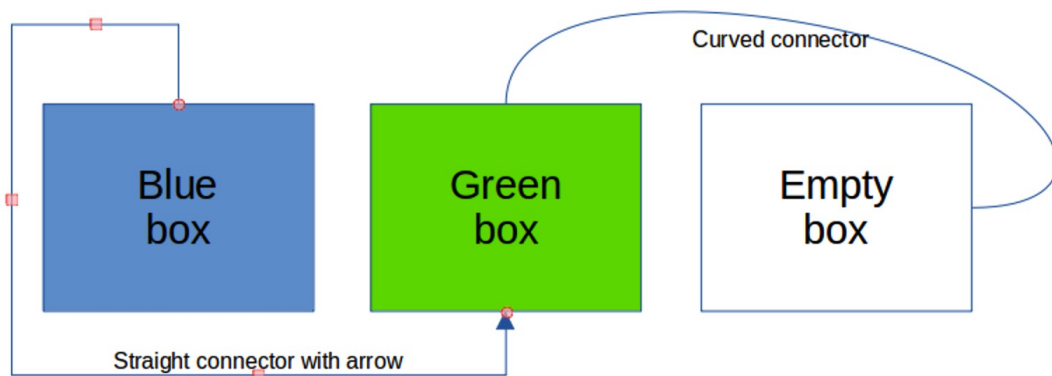

Figure 196: Example of connectors between objects

Connectors

Draw has a comprehensive selection of connectors to connect objects together, for example, in a flowchart or organization chart. The default set of connectors can be accessed using one of the following methods:

- Click the triangle ▼ to the right of **Connectors** on the Drawing toolbar to open a pop-up toolbar. The **Connectors** icon changes shape depending on the last connector used.
- Select a connector from the options available in the *Connectors* section in the **Shapes** deck on the Sidebar.

If necessary, the pop-up toolbar connectors can be displayed as a Connectors sub-toolbar as follows:

- 1) Click on the triangle ▼ on the right of **Connectors** on the Drawing toolbar.
- 2) Click on the line at the top of the pop-up toolbar and drag it on to the Workspace.
- 3) Release the mouse button and the pop-up toolbar becomes the Connectors sub-toolbar (Figure 197).



Figure 197: Connectors sub-toolbar

Connector types

The full range of predefined connectors can be accessed by clicking on the triangle ▼ on the right of the titlebar for the Connectors sub-toolbar and selecting **Visible Buttons** from the context menu. Depending on the computer system being used, the connectors already installed on the sub-toolbar are indicated either by a check mark against the name, or the connector icon is highlighted.

Connector type groups

- **Standard** – connector name starts with Connector. Line segments run vertically and horizontally. Creates a connector with one or more 90 degree angle bends. Click on an object glue point, then drag the cursor to a glue point on another object to create a standard connector.
- **Line** – connector name starts with Line. Consists of a line segment with two smaller segments at the ends and draws a connector that bends near a glue point. Click on an object glue point, then drag to a glue point on another object to create a line connector. To adjust the length of the line segment between a bend point and a glue point, click on the connector and drag the bend point.
- **Straight** – connector name starts with Straight. Consists of a single line and draws a straight line connector. Click on an object glue point, then drag the cursor to a glue point on another object to create a straight connector.
- **Curved** – connector name starts with Curved. Based on Bézier curves, a curved connector bends around objects. Draws a curved line connector. Click on an object glue point, then drag the cursor to a glue point on another object to create a curved connector.

Connector types

- | | |
|--|---|
| 1) Connector Ends with Arrow | 15) Curved Connector Starts with Arrow |
| 2) Straight Connector Ends with Arrow | 16) Line Connector Starts with Arrow |
| 3) Curved Connector Ends with Arrow | 17) Connector Ends with Circle |
| 4) Line Connector Ends with Arrow | 18) Straight Connector Ends with Circle |
| 5) Connector | 19) Curved Connector Ends with Circle |
| 6) Straight Connector | 20) Line Connector Ends with Circle |
| 7) Curved Connector | 21) Connector Starts with Circle |
| 8) Line Connector | 22) Straight Connector Starts with Circle |
| 9) Connector with Arrows | 23) Curved Connector Starts with Circle |
| 10) Straight Connector with Arrows | 24) Line Connector Starts with Circle |
| 11) Curved Connector with Arrows | 25) Connector with Circles |
| 12) Line Connector with Arrows | 26) Straight Connector with Circles |
| 13) Connector Starts with Arrow | 27) Curved Connector with Circles |
| 14) Straight Connector Starts with Arrow | 28) Line Connector with Circles |

Adding connectors to objects

- 1) Click on the triangle ▼ on the right of **Connectors** on the Drawing toolbar to open the options available for selecting connectors.
- 2) Select the type of connector required. See “Connector types” above for more information on connector types.
- 3) Move the cursor over one of the objects to be connected and small crosses appear around the object edges, normally in the same position as object selection handles. These crosses are the glue points to which a connector can be attached (Figure 198). See “Glue points” on page 172 for more information on glue points.
- 4) Click on the required glue point to attach the start point of the connector, then click and drag the cursor to draw a connector to another object.
- 5) When the cursor is over a glue point of the target object release the mouse button and the connector is drawn. The connector end point is attached to the glue point.

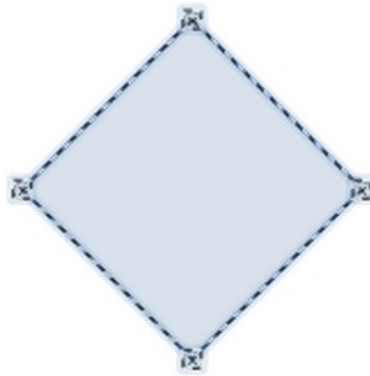

Figure 198: Example of object glue points

- 6) The square selection handles that appear on the connector are used to adjust the path of the connector so that it does not cover any other object in its path. See “Modifying connectors” below on how to change the connector route to avoid any objects the connector crosses over.

✓ Note

The end point of a connector can be positioned in an empty part of a document. When the mouse button is released, the unattached end point of the connector is locked into place until it is moved to a different location.

✓ Note

The start and end points of a connector cannot be swapped, that is the start point becomes the end point and the end point becomes the start point. To swap the end points of a connector, a new connector has to be drawn in the opposite direction.

Modifying connectors

To detach or reposition a connector, click and drag either round end point of a connector line to a different location. See the example in Figure 196 on page 169 for an example of round end points.

To change the connector route between objects so that the connector does not overlap any objects on the route, click on a square control point on the connector line and drag it to a new position. See the example in Figure 196 on page 169 for an example of square control points.

To modify a connector, right-click on the connector and select **Connector** from the context menu to open the Connector dialog (Figure 199). Use this dialog to change connector type and its properties.

- **Type** – select the connector type from the drop-down list. See “Connector types” on page 170 for more information.
- **Line skew** – defines the skew of a connector line. The dialog preview displays the result of any changes.
- **Line spacing** – sets the spacing around a connector.
 - *Begin horizontal* – enter the amount of horizontal space required at the beginning of a connector.
 - *Begin vertical* – enter the amount of vertical space required at the beginning of a connector.

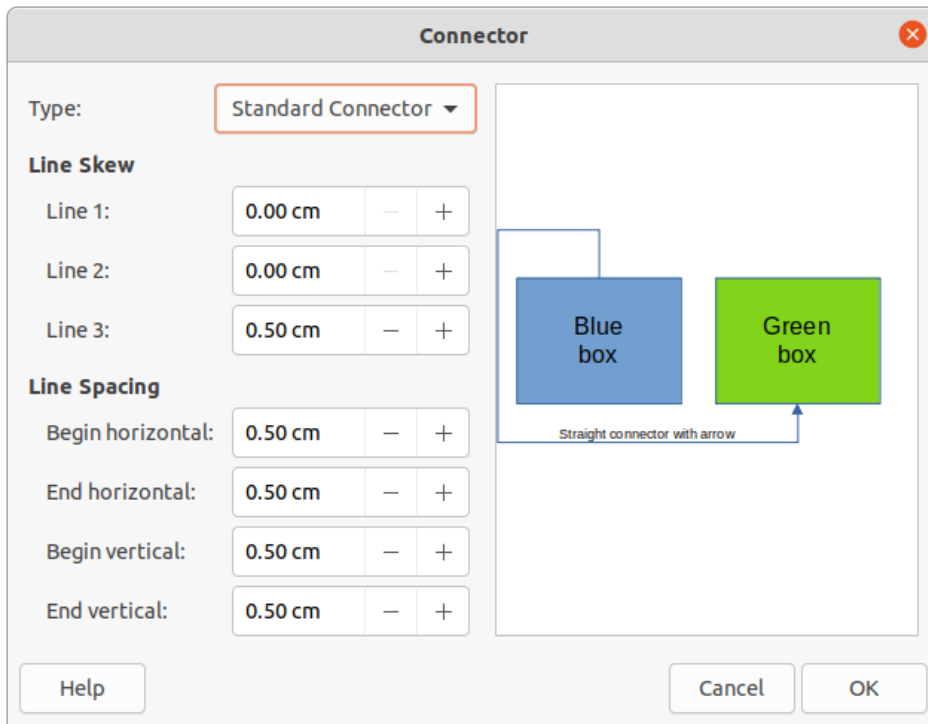

Figure 199: Connector dialog

- *End horizontal* – enter the amount of horizontal space required at the end of a connector.
- *End vertical* – enter the amount of vertical space required at the end of a connector
- **Preview box** – displays a preview of objects and connectors being used. A left click zooms in on the preview and a right-click zooms out.

Glue points

Glue points are not the same as object selection handles. The selection handles are for moving or changing the shape of an object (see Chapter 3, Working with Objects for more information). Glue points are used to fix or glue a connector to an object so that when the object moves, the connector stays fixed to that object.

All objects have glue points and Figure 198 on page 171 shows an example of glue points visible on an object after a connector has been selected. Glue points are not normally displayed on an object and only become visible when one of the following methods is used..

- **Connectors** is selected on the Drawing toolbar. The **Connectors** icon displayed on the Drawing toolbar is the connector type that had been previously used.
- A connector type is selected in the **Connectors** panel in the Shapes deck on the Sidebar.

To add, customize or delete glue points to an object, go to **View > Toolbars > Glue Points** on the Menu bar to activate the Glue Points toolbar (Figure 200). This toolbar only becomes visible after using one of the following methods:

- Click on **Show Glue Point Functions** on the Standard or Drawing toolbars.
- Select **Edit > Glue Points** on the Menu bar.

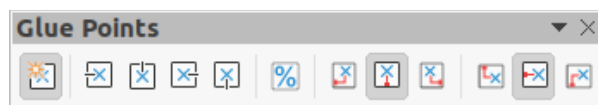

Figure 200: Glue Points toolbar

✓ Note

Show Glue Point Functions on the Drawing toolbar is not part of the default set of tools for the Drawing toolbar. To add this tool, right-click in an empty area on the Drawing toolbar and select **Visible Buttons > Glue Points** from the context menu.

Glue point types

When the Glue Points toolbar opens, only the five tools on the left of **Glue Point Relative** are active. The remaining six tools on the right of the toolbar only become active when **Glue Point Relative** is deselected.

- **Insert Glue Point** – inserts a glue point at the cursor position in an object when the mouse button is clicked.
- **Exit Direction Left** – connector attaches to the left edge of the selected glue point.
- **Exit Direction Top** – connector attaches to the top edge of the selected glue point.
- **Exit Direction Right** – connector attaches to the right edge of the selected glue point.
- **Exit Direction Bottom** – connector attaches to the bottom edge of the selected glue point.
- **Glue Point Relative** – when selected, the glue point moves when the object is resized maintaining its position relative to the object borders. When deselected, a glue point can be repositioned after the object is resized. This tool is selected by default when the Glue Point toolbar opens.

The following six tools only become active when **Glue Point Relative** is deselected.

- **Glue Point Horizontal Left** – when the object is resized, the selected glue point remains fixed at the left edge of the object.
- **Glue Point Horizontal Center** – when the object is resized, the selected glue point remains fixed at the center of the object.
- **Glue Point Horizontal Right** – when the object is resized, the selected glue point remains fixed at the right edge of the object.
- **Glue Point Vertical Top** – when the object is resized, the selected glue point remains fixed at the top edge of the object.
- **Glue Point Vertical Center** – when the object is resized, the selected glue point remains fixed at the vertical center of the object.
- **Glue Point Vertical Bottom** – when the object is resized, the selected glue point remains fixed at the bottom edge of the object.

✓ Note

Each glue point added to an object can have only one horizontal position and one vertical position. Only one of the horizontal position tools and one of the vertical position tools can be selected and used at any one time.

Adding glue points

By default, most objects normally have four glue points as shown in the example in Figure 198 on page 171. Add additional glue points to an object as follows:

- 1) Go to **View > Toolbars > Glue Points** on the Menu bar to activate the Glue Points toolbar.
- 2) Make sure no objects are selected and use one of the following methods to open the Glue Points toolbar:

- Click on **Show Glue Point Functions** on the Standard or Drawing toolbars.
 - Select **Edit > Glue Points** on the Menu bar.
- 3) Select the object, then click on **Insert Glue Point** on the Glue Points toolbar.
 - 4) Move the cursor to the required position on the selected object and the cursor changes shape to a cross (depending on the computer setup).
 - 5) Click once to add a glue point. To add more glue points, move the cursor to a new position and click.
 - 6) When finished adding glue points, move the cursor off the selected object and click in an empty space to deselect the object.
 - 7) Alternatively, right-click on a glue point previously added to the object and select **Insert Glue Point** from the context menu, then click and drag the new glue point to the required position.
 - 8) Select the type of glue point required from the options available on the Glue Points toolbar. See “Glue point types” above for more information.

Note

When an object has no fill, a glue point can only be added to the border of an empty object.

Tip

When adding, moving or customizing glue points, it is recommended to use the zoom function to make it easier to work with glue points. See Chapter 3, Working with Objects for more information. Also, glue points snap to the grid making it easier to position a glue point.

Customizing glue points

Only glue points that have been added to an object can be customized. The default glue points included with an object cannot be customized.

Customize the exit direction for a glue point that has been added to an object as follows:

- 1) Go to **View > Toolbars > Glue Points** on the Menu bar to activate the Glue Points toolbar.
- 2) Open the Glue Points toolbar:
- 3) Double-click on a glue point that has been added to an object to select the glue point for customization.
- 4) Select the exit direction required for the connector to be attached to the glue point using one of the following methods:
 - Click on the exit direction in the Glue Points toolbar.
 - Right-click on the glue point and select the exit direction from the context menu.

Customize the horizontal and vertical positioning for a glue point that has been added to an object as follow:

- 1) Go to **View > Toolbars > Glue Points** on the Menu bar to activate the Glue Points toolbar.
- 2) Open the Glue Points toolbar:
- 3) Double-click on a glue point that has been added to an object to select the glue point for customization.

- 4) Click on **Glue Point Relative** on the Glue Points toolbar to deselect this tool, or right-click on the glue point and select **Glue Point Relative** from the context menu to deselect the tool.
- 5) Select the horizontal and vertical positioning tools required for the glue point using one of the following methods Only one horizontal positioning tool and one vertical positioning tool can be used at any one time:
 - Click on the horizontal and vertical positioning required in the Glue Points toolbar.
 - Right-click on the glue point and select the horizontal and vertical positioning required from the context menu.

Deleting glue points

Only glue points that have been added to an object can be deleted. The default glue points included with an object cannot be deleted.

- 1) Select a glue point for deletion that has previously been added to the object.
- 2) Press the *Delete* or *Backspace* key, or go to **Edit > Cut** on the Menu bar.

Connector text

Text can be easily added to connectors, then formatted, for example, to make a flowchart or organization chart easier to follow. See Chapter 9, Adding and Formatting Text for more information on working with and formatting text.

Adding text

- 1) Select a connector and the control points become active.
- 2) Enter text mode using one of the following methods:
 - Click on **Insert Text Box** or **Insert Vertical Text** (if added) on the Standard toolbar (Figure 201).
 - Click on **Insert Text Box** or **Insert Vertical Text** (if added) on the Drawing toolbar (Figure 202).
 - Use the keyboard shortcut *F2* to create horizontal text on the selected connector.

A flashing text cursor appears close to the connector and the Text Formatting toolbar (Figure 203) opens.

- 3) Type the required text for the connector.
- 4) If necessary, format the connector text. See “Formatting and editing text” below for more information on formatting and editing text text.
- 5) When adding and formatting text is complete, move the cursor away from the text and connector, then click to end text mode. This also closes the Text Formatting toolbar.

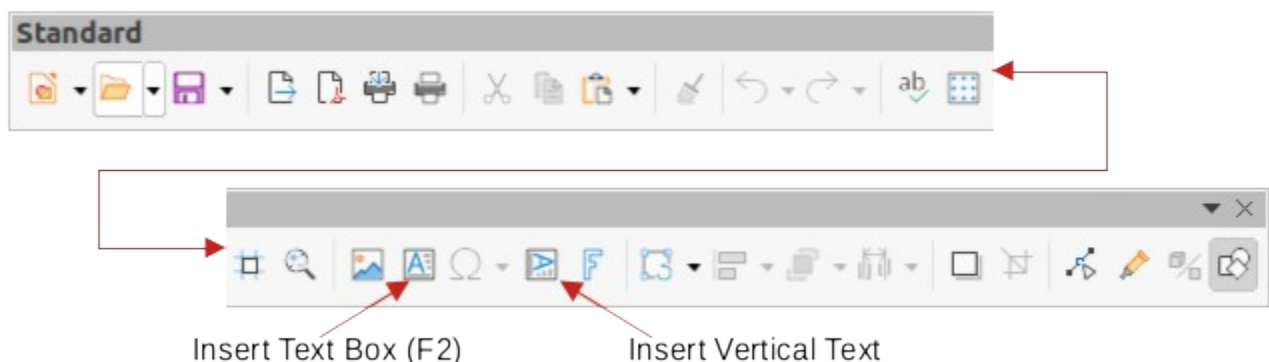

Figure 201: Standard toolbar with Insert Vertical Text added

Insert Text Box (F2)



Insert Vertical Text

Figure 202: Drawing toolbar with Insert Vertical Text added

✓ Note

In the default installation of LibreOffice, the **Insert Vertical Text** tool is not included on the Standard or Drawing toolbars. To add **Insert Vertical Text** to the toolbar, right-click in an empty area in either toolbar, go to **Visible Buttons** and select **Vertical Text** from the context menu.

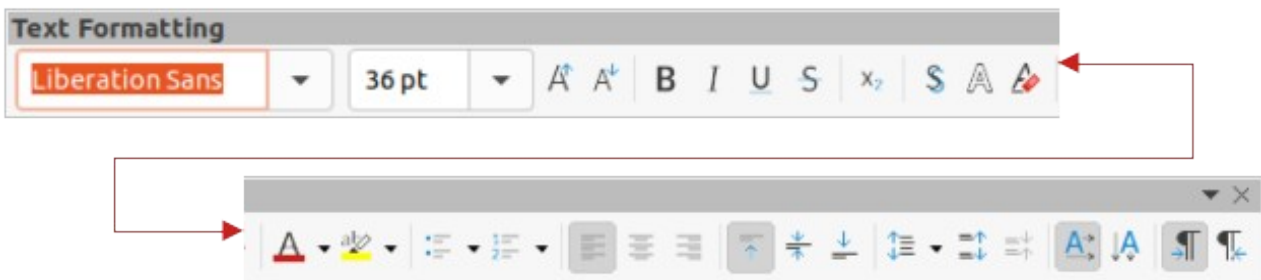

Figure 203: Text Formatting toolbar

Formatting and editing text

- 1) Select a connector with text added and activate the control points to enter text mode. See "Adding text" above for more information on adding text to a connector.
- 2) Use the tools available on the Text Formatting toolbar or the options available in **Format > Text** on the Menu bar to format the text.
- 3) Right-click on the connector text and select **Text** from the context menu to open the Text dialog (Figure 204) and change how the text appears next to the connector. The options available are as follows:
 - **Drawing Object Text – Fit to frame** – resizes the text to fit the entire area of a connector rectangle or frame.
 - **Drawing Object Text – Adjust to contour** – adapts the text flow so that it matches the contours of the selected connector.
 - **Spacing to Borders** – specify the amount of space to leave between the connector and the borders of the text.
 - **Text Anchor** – select one of nine positions to anchor the text within the connector rectangle.
 - **Full width** – anchors the text to the full width of the connector rectangle. When selected, the top, middle and bottom center positions can be used for to anchor the text.
- 4) If required, click on **Text Animation** to open the Text Animation page (Figure 205) and access options to animate the text. However, this is not recommended unless the drawing is going to be displayed as part of a presentation. See the *Impress Guide* for more information on text animation.
- 5) Click **OK** to save the changes to text attributes and close the Text dialog.

- 6) Move the cursor away from text and connector, then click to end the text mode. This also closes the Text Formatting toolbar.

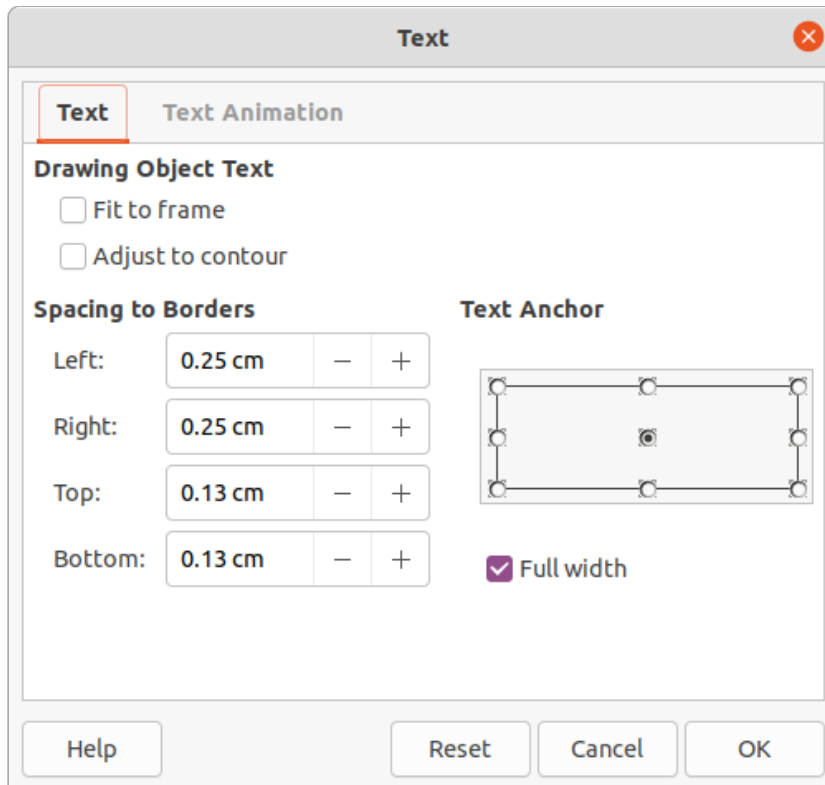

Figure 204: Text dialog

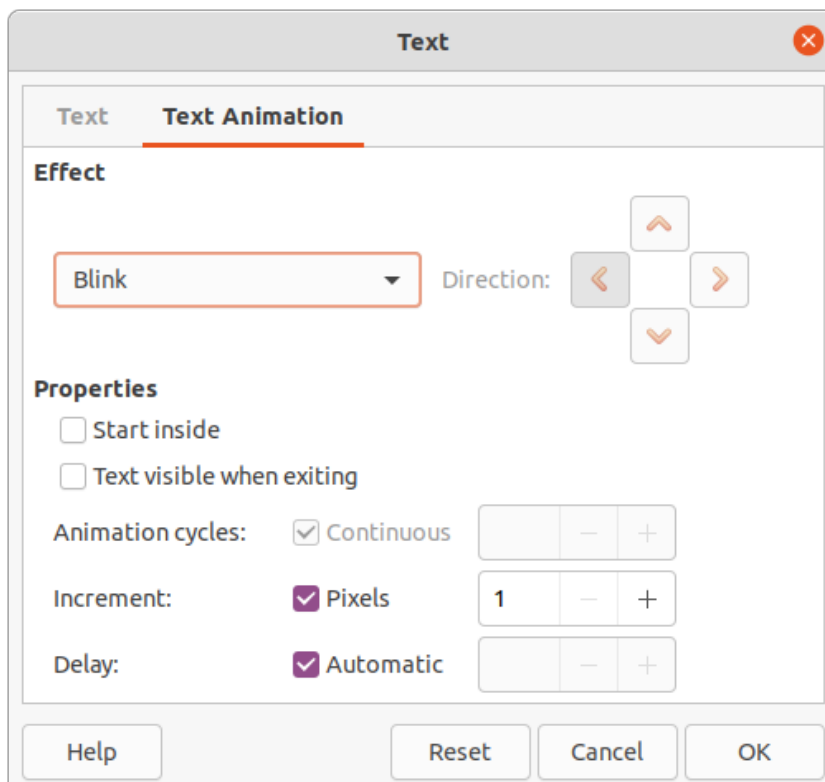

Figure 205: Text dialog - Text Animation page

Flowcharts

For drawing flowcharts (also known as flow diagrams), Draw has a floating Flowchart sub-toolbar (Figure 206) that includes a large selection of flowchart tools to create a flowchart.

- 1) Click on the triangle ▼ to the right of **Flowchart** on the Drawing toolbar to open a Flowchart pop-up menu. Note that the Flowchart icon changes shape depending on the last flowchart tool used.
- 2) Click at the top of the Flowchart pop-up menu and drag it into the Workspace.
- 3) Release the mouse button and the pop-up menu becomes a floating Flowchart sub-toolbar.



Figure 206: Flowchart sub-toolbar

Available flowchart shapes, left to right

- | | |
|-----------------------------------|--------------------------------------|
| 1) Flowchart: Process | 15) Flowchart: Card |
| 2) Flowchart: Alternate Process | 16) Flowchart: Punched Type |
| 3) Flowchart: Decision | 17) Flowchart: Summing Junction |
| 4) Flowchart: Data | 18) Flowchart: Or |
| 5) Flowchart: Predefined Process | 19) Flowchart: Collate |
| 6) Flowchart: Internal Storage | 20) Flowchart: Sort |
| 7) Flowchart: Document | 21) Flowchart: Extract |
| 8) Flowchart: Multidocument | 22) Flowchart: Merge |
| 9) Flowchart: Terminator | 23) Flowchart: Stored Data |
| 10) Flowchart: Preparation | 24) Flowchart: Delay |
| 11) Flowchart: Manual Input | 25) Flowchart: Sequential Access |
| 12) Flowchart: Manual Operation | 26) Flowchart: Magnetic Disc |
| 13) Flowchart: Connector | 27) Flowchart: Direct Access Storage |
| 14) Flowchart: Off-page Connector | 28) Flowchart: Display |

An example flowchart is shown in Figure 207 and the recommended basic steps when creating a flowchart are as follows:

- When adding objects or flowchart shapes to a flowchart, see Chapter 2, Drawing Basic Shapes for information on how to draw and resize object shapes.
- Add text to each flowchart shape to make it easily identified in the flowchart. See Chapter 2, Drawing Basic Shapes and Chapter 11, Advanced Draw Techniques for more information.
- Use connector lines in a flowchart. This allows repositioning of an object in a flowchart while maintaining connections with the other objects in the flowchart. See “Connectors and glue points” on page 169 for more information.
- Use the zoom, grid, and snap functions to help in positioning objects in a flowchart. See Chapter 3, Working with Objects and Object Points for more information.
- Use the alignment and distribution functions to give a flowchart a more professional look. See Chapter 5, Combining Multiple Objects for more information.
- Duplicate objects when more than one of the same shape and size is required. See Chapter 5, Combining Multiple Objects for more information.

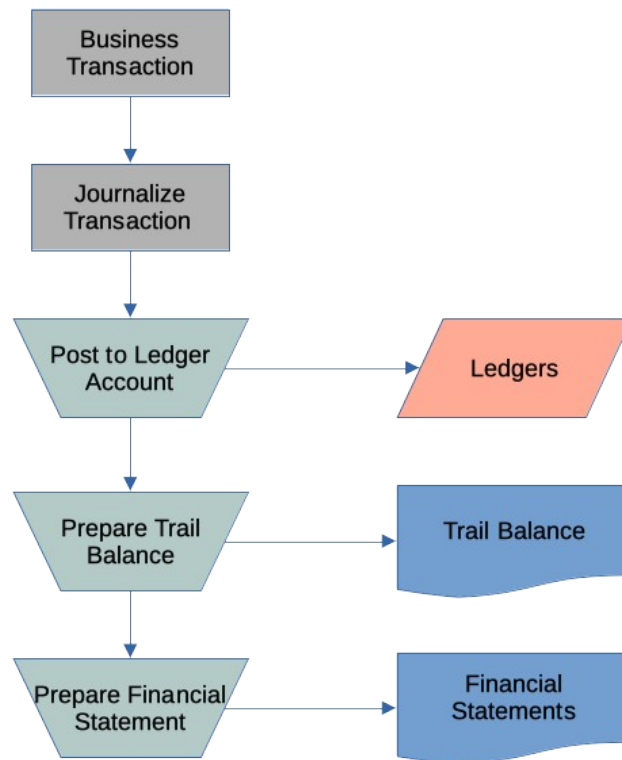

Figure 207: Example flowchart

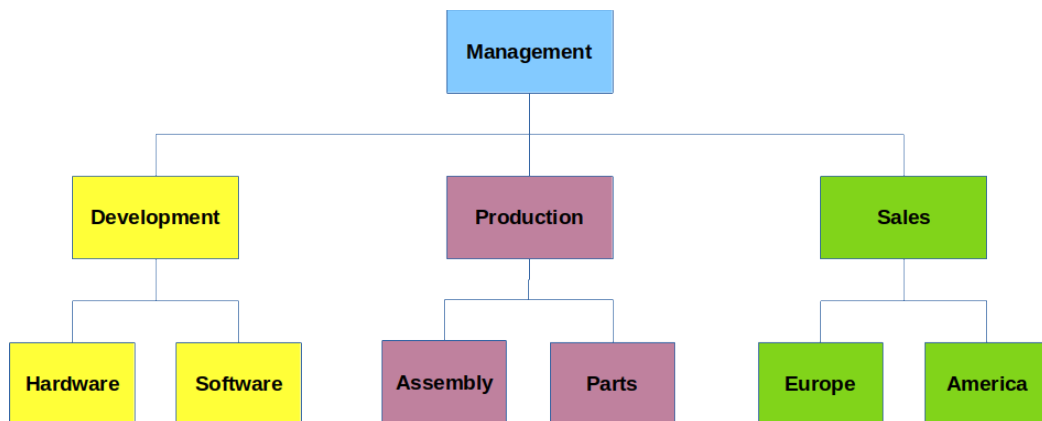

Figure 208: Example of an organization chart

Organization charts

Draw does not have a toolbar for organization charts, but these charts are easily created using basic shapes, flowchart shapes, and connectors. Hierarchy in an organization is easily indicated using shading and/or color. When using shading and color in an organization chart, make sure the selection provides a good contrast between the text and the shading or color. This makes the chart easy to read on a computer display or in a printed document.

An example of an organization chart is shown in Figure 208. This was drawn using the rectangle basic shape and connectors.

- When adding objects to a chart, see Chapter 2, Drawing Basic Shapes for information on how to draw and resize object shapes.
- Add text to each object in the organization chart to make it easily identified in the chart. See Chapter 2, Drawing Basic Shapes and Chapter 11, Advanced Draw Techniques for more information.

- Use connectors in an organization chart. This allows repositioning of an object in a chart while maintaining connections with the other objects in the chart. See “Connectors and glue points” on page 169 for more information.
- Use the zoom, grid, and snap functions to help in positioning objects in a chart. See Chapter 3, Working with Objects and Object Points for more information.
- Use the alignment and distribution functions to give an organization chart a more professional look. See Chapter 5, Combining Multiple Objects for more information.
- Duplicate objects when more than one of the same shape and size is required. See Chapter 5, Combining Multiple Objects for more information.



LibreOffice
Community



Draw Guide 7.2

Chapter 9, Adding and Formatting Text

Introduction

When text is used in drawings, it is placed inside an object or inside a text box. This chapter describes how to create, format, use, and delete text. It also discusses the various types of text that can be inserted into a drawing. Finally, it provides information on how to insert special forms of text such as numbered or bulleted lists, tables, fields, hyperlinks, and Fontwork.

Text mode

Before any text can be typed in a drawing, text mode has to be activated using one of the following methods. The Text Formatting toolbar automatically opens when in text mode replacing the Line and Filling toolbar.

- For horizontal text only, go to **Insert > Text Box** on the Menu bar.
- For horizontal text only, use the keyboard shortcut *F2*.
- Click on **Insert Text Box** for horizontal text or **Insert Vertical Text** for vertical text on the Standard toolbar (Figure 209) or Drawing toolbar (Figure 210).

If **Insert Vertical Text** is not visible on the Standard or Drawing toolbars, it can be added to the toolbar as follows:

- 1) Go to **Tools > Options > Language Settings > Languages** on the Menu bar to open the Languages page in the Options dialog.
- 2) In **Default Languages for Documents**, select the option *Asian*. Accept the default settings for this option.
- 3) Click **OK** to close the Options dialog and save the changes.
- 4) Right-click in an empty area on the Standard or Drawing toolbar and select **Visible Buttons** from the context menu.
- 5) Select **Vertical Text** from the drop-down list of options to add **Insert Vertical Text** to the Standard or Drawing toolbar.

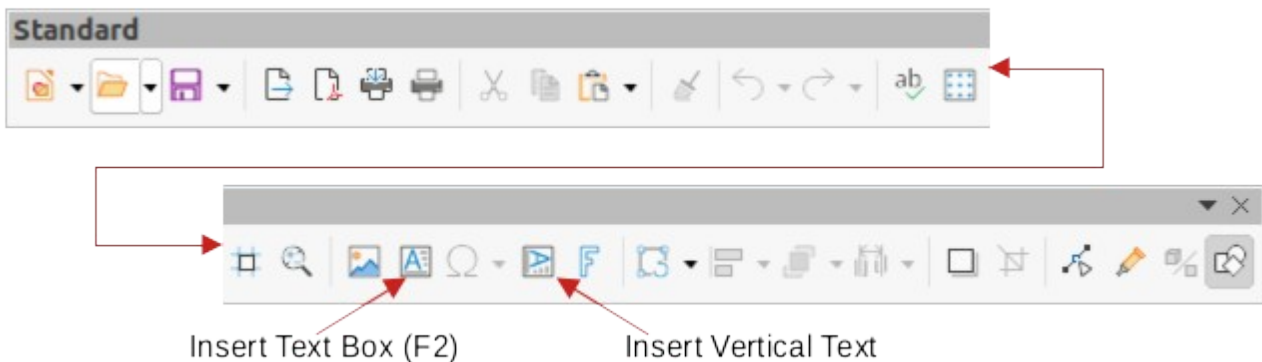

Figure 209: Standard toolbar with Insert Vertical Text added

Insert Text Box (F2)

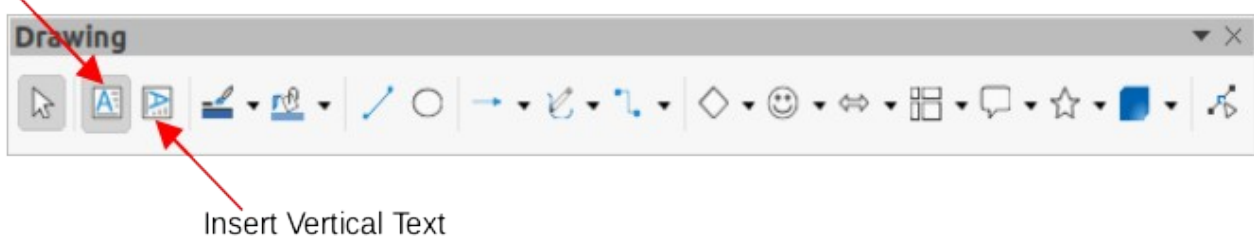

Figure 210: Drawing toolbar with Insert Vertical Text added

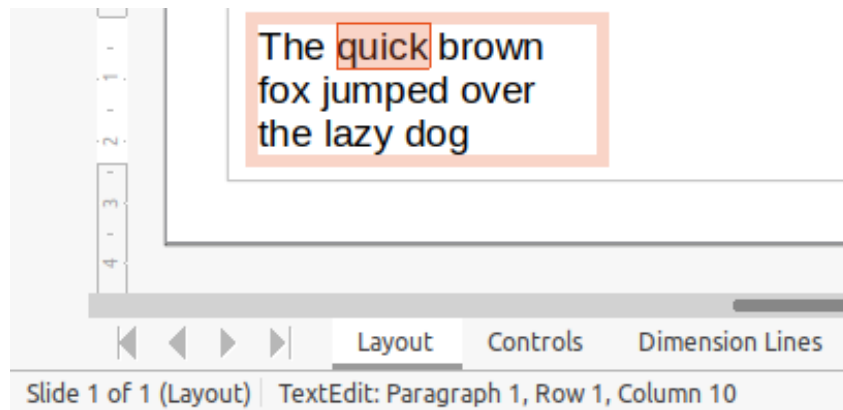

Figure 211: Text information in Status Bar

Text boxes

Creating text boxes

When text is added to a drawing, a text box is automatically created to contain the text. By default, the text box expands horizontally to accommodate a single line of horizontal text, or expands vertically to accommodate a single line of vertical text.

- 1) Activate text mode, see “Text mode” above.
- 2) Click at the approximate position in the drawing where the text box is to be placed. A text box is created containing a flashing text cursor.
- 3) Type or paste the text into the text box and the text box expands either horizontally or vertically to accommodate a single line of text. Also, the left corner of the Status Bar indicates text edit mode and the position of the text cursor (Figure 211).
- 4) To create multiple lines in the text box, use one of the following methods:
 - Use the *Enter* key to create single line paragraphs inside the text box. The text box expands to accommodate more lines of text.
 - Before typing text, click and drag the text cursor creating a text box with the approximate dimensions required. As the limits of the text box are reached, the text automatically word wraps inside the text box and the text box expands as it fills.
- 5) Move, resize, rotate or format the text box as required. For more information, see the following sections and Chapter 3, Working with Objects.
- 6) Format the text using the various tools on the Text Formatting toolbar, the various panels in the Properties deck on the Sidebar, or the various options in **Format** on the Menu bar. For more information on text formatting, see “Formatting text” on page 191.
- 7) When text insertion and formatting is complete, click outside the text box to save the changes and deselect the text box.

Note

Text boxes cannot contain illustrations, inline pictures, formulas, tables or shapes.

Moving text boxes

- 1) Click on the text in a text box to activate the text mode and the text box border is displayed.
- 2) Move the cursor over the border. The cursor changes shape to the move symbol for the computer setup (for example, a clenched hand).

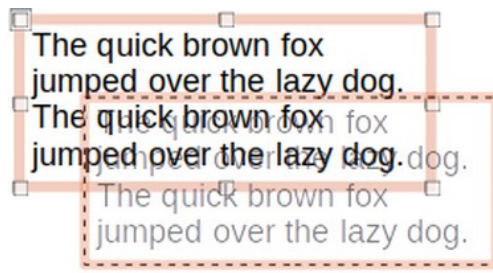

Figure 212: Moving a text box

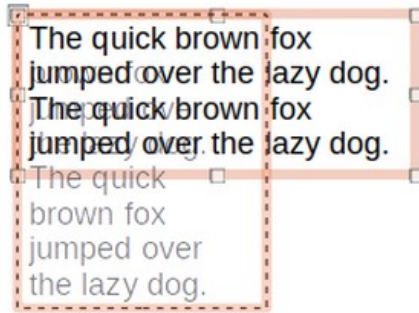

Figure 213: Resizing a text box

- 3) Click on the border and drag the text box to a new position in the drawing. A ghosted outline of the text box shows where it will be placed (Figure 212).
- 4) Release the mouse button when the text box is in the required position.
- 5) To accurately position a text box, use the Position and Size dialog or the Position and Size panel in the Properties deck on the Sidebar. See Chapter 3, Working with Objects for more information.
- 6) When the text box is in the required position, click outside the text box to save the changes and deselect the text box.

Resizing text boxes

- 1) Click on the text in a text box to activate text mode and a text box border is displayed.
- 2) Move the cursor over one of the selection handles. The cursor changes shape to the resizing symbol for the computer setup (for example, a double-headed arrow). The selection handles are used to resize the text box as follows:
 - Corner handles change the width and height of the text box simultaneously.
 - Top and bottom selection handles change the height of the text box.
 - Right and left selection handles change the width of the text box.
- 3) Click and drag the border to a new position to resize the text box. A ghosted outline of the text box shows is displayed as the text box is resized (Figure 213).
- 4) Release the mouse button when the text box reaches the desired size.
- 5) To accurately resize a text box, use the Position and Size dialog or the Position and Size panel in the Properties deck on the Sidebar. See Chapter 3, Working with Objects for more information.
- 6) When the text is at the required size, click outside the text box to save the changes and deselect the text box.

Note

Press and hold the *Shift* key to maintain text box proportions, then click and drag a selection handle to resize. Release the mouse button before releasing the *Shift* key.

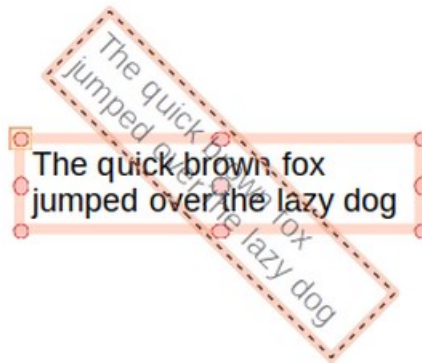

Figure 214: Rotating text box

Rotating text boxes

- 1) Click on the text in a text box to activate text mode and a text box border is displayed.
- 2) Click on the text box border so that the selection handles are visible indicating that the text box is now in edit mode.
- 3) Click again on the text border and the selection handles change shape and color.
- 4) Click on a corner selection handle and drag to rotate the text box. A ghosted outline of the text box being rotated appears and the current angle of rotation is shown in the status bar (Figure 214).
- 5) Release the mouse button when the text box is at the desired rotation angle.
- 6) To accurately rotate a text box, use the Rotation page in Position and Size dialog or the Position and Size panel in the Properties deck on the Sidebar. See Chapter 3, Working with Objects for more information.

✓ Note

When in rotation mode, the top, bottom, and side selection handles, though visible, are not available for use for rotating a text box. Also, text boxes cannot be sheared, slanted, flipped vertically, or flipped horizontally.

Formatting text boxes

Text boxes can be treated just like other basic shapes in a drawing when formatting the area fill or borders of a box. See Chapter 3, Working with Objects for more information on formatting the area fill or borders of a text box.

After formatting text to match the drawing requirements, format a text box as follows so that text appears correctly inside a text box:

- 1) Select a text box and use one of the following methods to open the Text dialog (Figure 215).
 - Right-click on the text box and select **Text Attributes** from the context menu.
 - Go to **Format > Text Attributes** on the Menu bar.
- 2) Click on **Text** in the Text dialog to open the **Text** page and access to the formatting options:
 - **Drawing Object Text – Fit width to text** – expands the width of the text box to the length of the text, if the text box is smaller than the text.
 - **Drawing Object Text – Fit height to text** – expands the height of the text box to the height of the text, if the text box is smaller than the text.

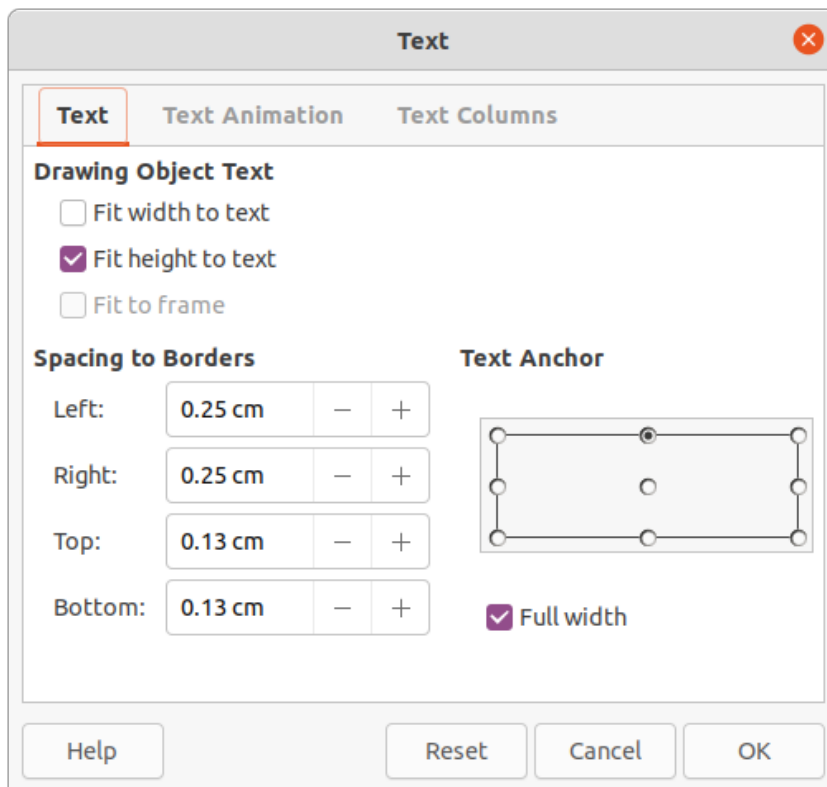

Figure 215: Text dialog for text boxes - Text page

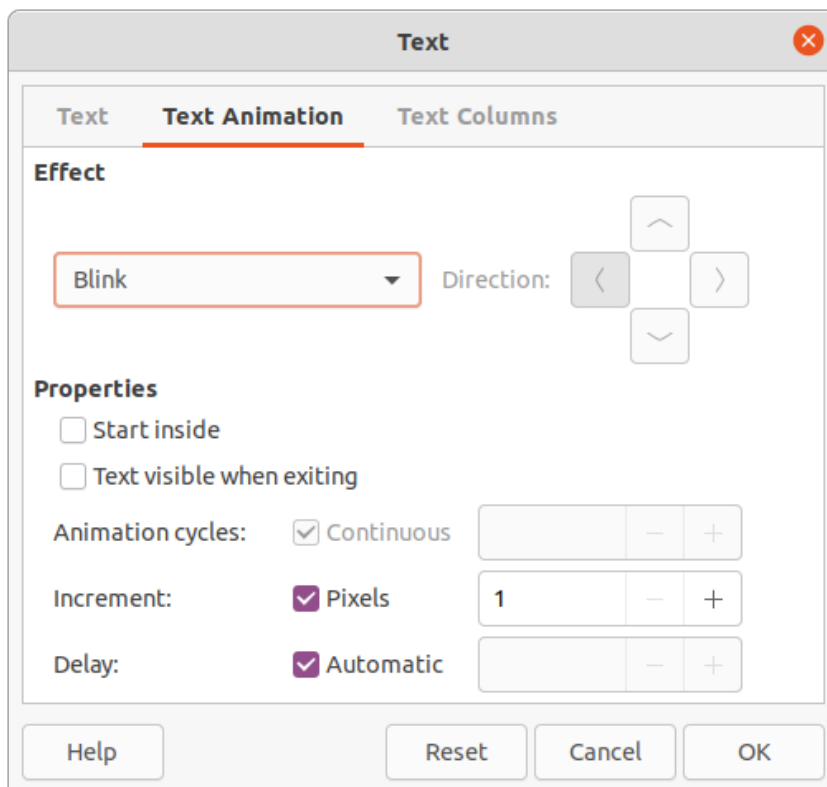

Figure 216: Text dialog for text boxes - Text Animation page

- **Drawing Object Text** – *Fit to frame* – resizes (distorts) the text to fit the entire area of the text box. This option is not available if *Fit width to text* and/or *Fit height to text* options are selected.
- **Spacing to Borders** – specify the amount of space to leave between the text and the borders of the text box.

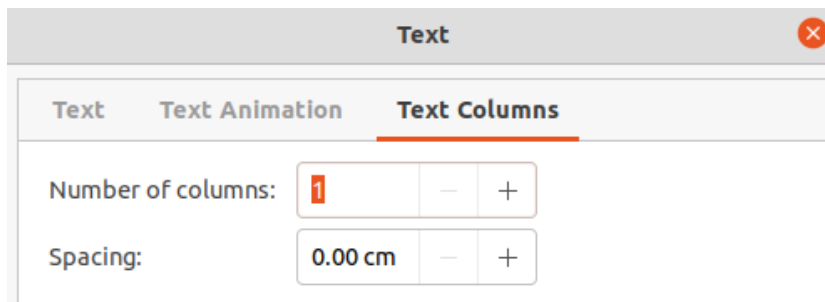

Figure 217: Text dialog for text boxes - Text Columns page

- **Text Anchor** – select one of nine positions to anchor the text within the text box.
 - **Full width** – anchors the text to the full width of the text box. When selected, the top, middle or bottom center positions in **Text Anchor** are used to anchor the text.
- 3) If required, click on **Text Animation** to open the Text Animation page (Figure 216) to access options for animating the text. However, this is not recommended unless the drawing is going to be displayed as part of a presentation. See the *Impress Guide* for more information on text animation.
 - 4) If required, click on **Text Columns** to open the Text Columns page (Figure 217) to access the options for creating columns in a text box as follows. For more information on text columns, see “Text columns” on page 207.
 - a) Enter the number of columns required in the *Number of columns* box.
 - b) Enter the required spacing between columns in the *Spacing* box.
 - 5) Click **OK** to save the changes to text attributes and close the Text dialog.
 - 6) Move the cursor away from the text box, then click to end the text mode.

Deleting text boxes

- 1) Click on the text box so that the selection handles are visible indicating that the text box is in edit mode.
- 2) Press the *Delete* or *Backspace* key. The text box is deleted without any warning.

Text in Draw objects

Text can be added to most Draw objects. The exceptions are control elements, for example buttons, polygons, curves, or 3D objects.

By default, an object is not dynamic when it is first created in Draw and does not behave like a text box. By default, text does not word wrap inside an object. To keep text within the borders of an object, use word wrap, paragraphs, line breaks, smaller text size, increasing object size, or a combination of all methods.

An example of adding text into a Draw object is shown in Figure 218. The left object does not have the word wrap option applied and the right object has the word wrap option applied.

- 1) Create an object in a drawing and make sure the object is selected with the selection handles displayed.
- 2) Enter text mode on the selected object using one of the following methods:
 - Click on **Insert Text Box** for horizontal text or **Insert Vertical Text** for vertical text on the Standard or Drawing toolbar.
 - For horizontal text, double-click on the selected object.
 - For vertical text, double-click on the selected object and click on **Insert Vertical Text** on the Standard or Drawing toolbar.

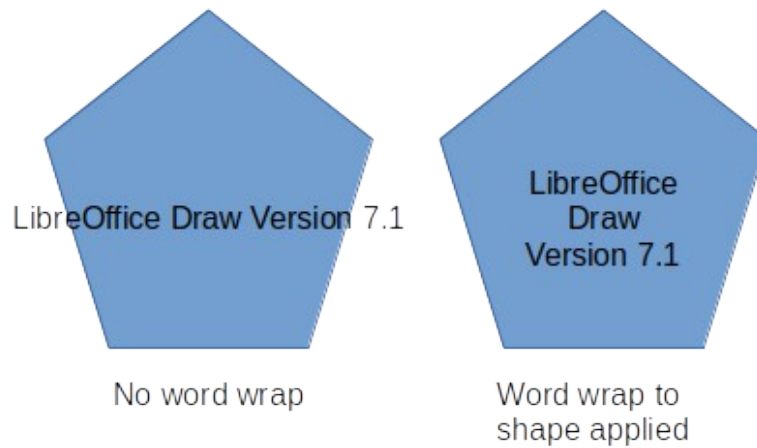

Figure 218: Example of using word wrap

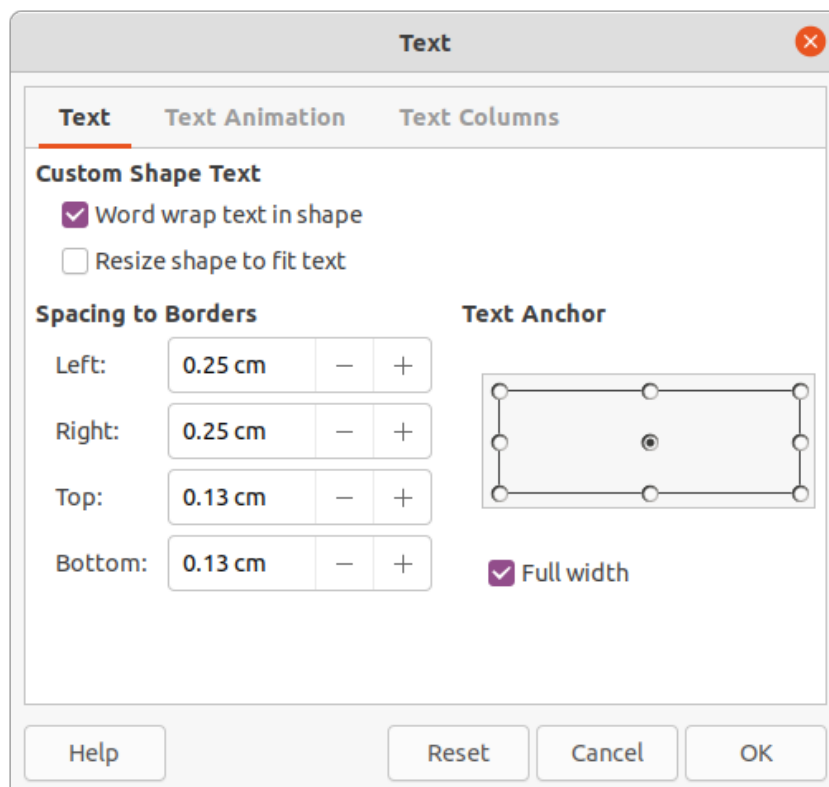

Figure 219: Text dialog for text in objects – Text page

- 3) Type or paste text into the selected object.
- 4) Format the text using the various tools on the Text Formatting toolbar, the panels in the Properties deck on the Sidebar, or the options in **Format** on the Menu bar. For more information on text formatting, see “Formatting text” on page 191.
- 5) If the text goes outside the object borders, click on **Text** in the Text dialog to open the **Text** page (Figure 219) and access to the formatting options:
 - **Custom Shape Text** – *Word wrap text in shape* – wraps the text so that it fits inside the object.
 - **Custom Shape Text** – *Resize shape to fit text* – resizes the object to fit the text that is being entered into the object.
 - **Spacing to Borders** – specify the amount of space to leave between the text and the borders of the object.

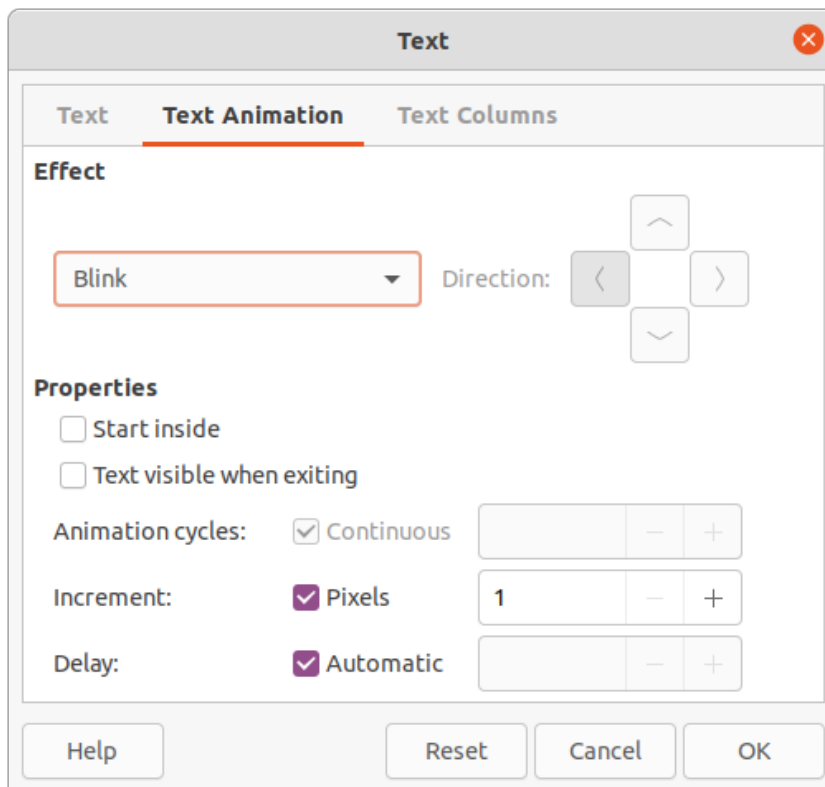

Figure 220: Text dialog for objects - Text Animation page

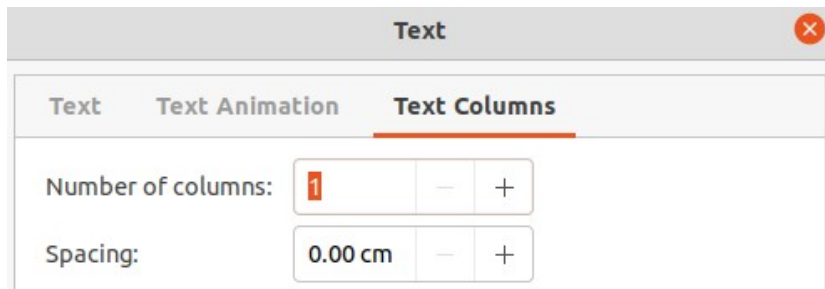

Figure 221: Text dialog for objects - Text Columns page

- **Text Anchor** – select one of nine positions to anchor the text within the object.
 - **Full width** – anchors the text to the full width of the object. When selected, the top, middle or bottom center positions in **Text Anchor** are used to anchor the text.
- 6) If required, click on **Text Animation** to open the Text Animation page (Figure 220) to access options for animating the text. However, this is not recommended unless the drawing is going to be displayed as part of a presentation. See the *Impress Guide* for more information on text animation.
 - 7) If required, click on **Text Columns** to open the Text Columns page (Figure 221) to access the options for creating columns in a text box as follows:
 - a) Enter the number of columns required in the *Number of columns* box.
 - b) Enter the required spacing between columns in the *Spacing* box.
 - 8) Click **OK** to save the changes to text attributes in the object and close the Text dialog.
 - 9) Move the cursor away from the object, then click to end the text mode.

Pasting text

Text may be inserted into a text box or object by copying text from another document and pasting into a drawing. However, pasted text retains the formatting from the source document and may not match the formatting of the text that has already been used on a drawing. This may match the text format in a drawing on some occasions, but, in most cases, it is better to make sure that text format is consistent throughout a drawing.

✓ Note

When using **Format > Paste** on the Menu bar, or the keyboard shortcut *Ctrl+V*, to paste copied text directly into a drawing and not into an object, the text is pasted as an OLE object and not as a Draw object. It is recommended to paste text into Draw as unformatted text to create a text object in Draw.

It is good practice to paste text without formatting and apply the formatting later so it matches the text already in a drawing.

- 1) Copy the text and paste it as unformatted text into a drawing using one of the following methods:
 - Go to **Edit > Paste Special > Paste Unformatted** Text on the Menu bar.
 - Go to **Edit > Paste Special > Paste Special** on the Menu bar and the Paste Special dialog (Figure 222) opens. Select the option *Unformatted text* and click **OK** to close the dialog.
 - Use the keyboard shortcut *Control+Shift+V* and the Paste Special dialog opens. Select the option *Unformatted text* and click **OK** to close the dialog.
 - Click on the triangle ▼ on the right of **Paste** on the Standard toolbar and select **Unformatted text** from the context menu.
- 2) The unformatted text is pasted into a text box at the cursor position or inside a selected object and formatted to the default drawing style. Format the pasted text to the drawing requirements or apply a drawing style. For more information, see “Formatting text” below.

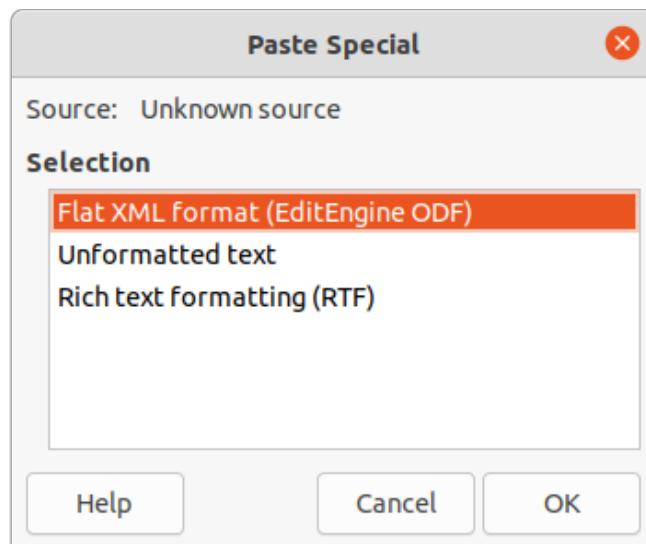

Figure 222: Paste Special dialog

Formatting text

Text formatting can give a drawing a more consistent and professional look without any distracting elements. Text formatting tools are available on the Text Formatting toolbar and drop-down menus in **Format** on the Menu bar. For more information on text formatting, see the *Writer Guide*.

If there are several text boxes and/or objects in a drawing that require the same text formatting, it is recommended to use drawing styles. For more information on using and creating styles, see Chapter 4, Changing Object Attributes.

Quick font resizing

After selecting text, the font size can be quickly increased or decreased using the tools **Increase Font Size (Ctrl+I)** and **Decrease Font Size (Ctrl+J)** on the Text Formatting toolbar. The amount by which the font size changes depends on the standard sizes available for the font in use.

Selecting text

Text must be selected before it can be formatted using one of the following methods. Any formatting changes apply only to the selected text.

- To format all the text in a text box or object, click once on the border of the text box or object to display the selection handles. Any formatting changes then apply to all text in the text box or object.
- To format only part of the text, select text using one of the following methods:
 - Click in the text and drag the cursor over the text to highlight the text.
 - Double-click on text to select a complete word or triple-click to select a whole paragraph.
 - Click in the text, then press and hold the *Shift* key and use the keyboard arrow keys to select text.

Text formatting

Text formatting can be applied directly to characters, words, sentences, and paragraphs. Direct formatting to text overrides any formatting that has been applied using styles.

- 1) Select the text for formatting.
- 2) Format the selected text using one of the following methods:
 - Various formatting tools on the Text Formatting toolbar.
 - Go to **Format** on the Menu bar and select a formatting option from the drop-down menu. Selecting a formatting option opens either a context menu or a dialog providing further formatting options to apply to the selected text.
 - Use the options in the Paragraph and Character dialogs.
 - Use the options in the *Paragraph* and *Character* panels in the Properties deck on the Sidebar.
- 3) Click outside the text box or object to deselect the text.

Paragraph dialog

The Paragraph dialog (Figure 223) is used to format paragraphs of text.

- 1) Click anywhere in the paragraph that is to be formatted.

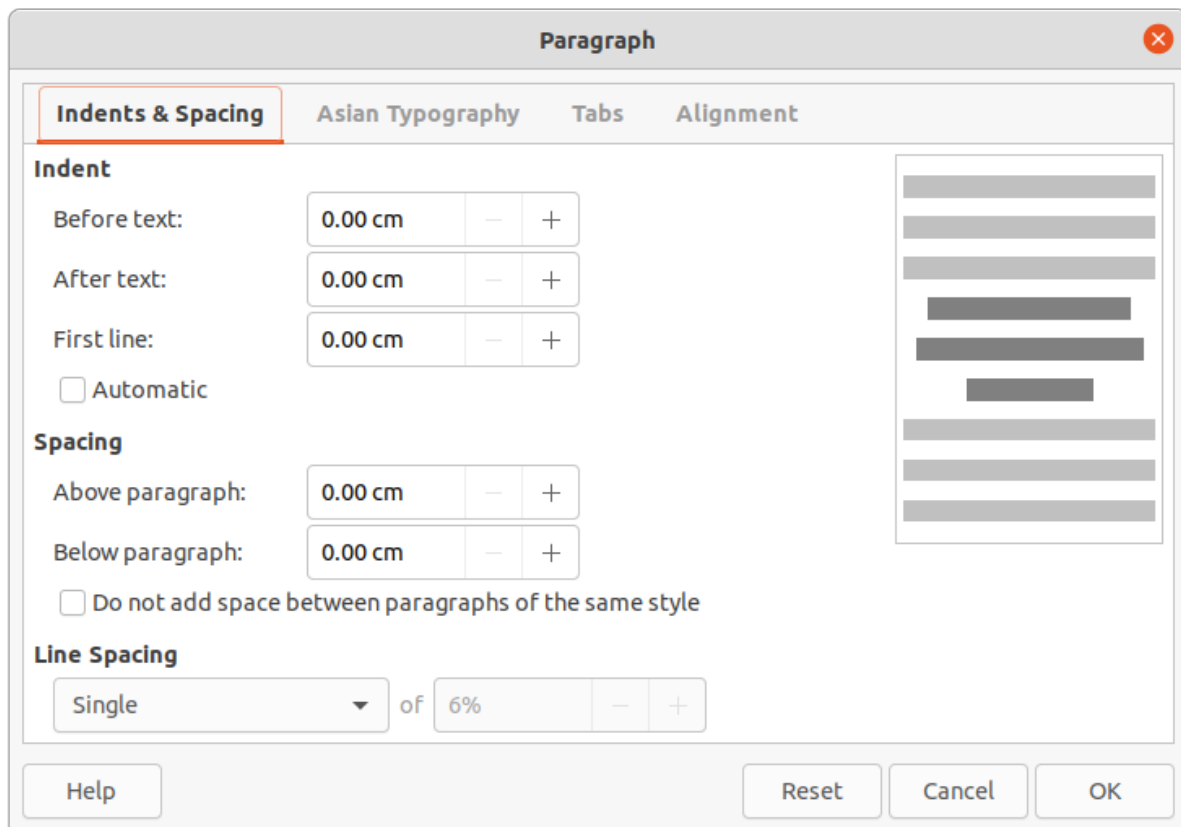

Figure 223: Paragraph dialog - Indents & Spacing page

- 2) Use one of the following methods to open the Paragraph dialog.
 - Right-click on the selected text and select **Paragraph** from the context menu.
 - Go to **Format > Paragraph** on the Menu bar.
- 3) Use the various options on the tabbed pages of the Paragraph dialog to format the text.
- 4) Click **OK** to save the changes and close the Paragraph dialog.
- 5) Click outside the text box or object to deselect the text.

Indents and spacing options

The **Indents & Spacing** page (Figure 223) in the Paragraph dialog has three main sections:

- **Indent** – specifies the amount of space to leave between the left and the right page margins and the paragraph.
 - *Before text* – enter the amount of space required to indent the paragraph from the page margin. If the paragraph extends into the page margin, enter a negative number.
 - *After text* – enter the amount of space required to indent the paragraph from the page margin. If the paragraph is to extend into the page margin, enter a negative number.
 - *First line* – indents the first line of a paragraph by the amount entered. To create a negative hanging indent enter a positive value for *Before text* and a negative value for *First line*. To create a positive hanging indent enter a positive value for *Before text* and a larger positive value for *First line*.
 - *Automatic* – when selected, automatically indents a paragraph according to the font size and the line spacing. The setting value for *First line* is ignored.
- **Spacing** – specifies the amount of space to leave between paragraphs.
 - *Above paragraph* – enter the amount of space required above a paragraph.

- *Below paragraph* – enter the amount of space required below a paragraph.
- *Do not add space between paragraphs of the same style* – when selected, only the spacing below a paragraph is applied when the preceding and following paragraphs are of the same paragraph style.
- **Line spacing** – specifies the amount of space to leave between lines of text in a paragraph. The options available from the drop-down list are as follows:
 - *Single* – applies single line spacing to a paragraph. This is the default setting.
 - *1.15 Lines* – sets the line spacing to 1.15 lines.
 - *1.5 Lines* – sets the line spacing to 1.5 lines.
 - *Double* – sets the line spacing to two lines.
 - *Proportional* – select this option and then enter a percentage value in the box, where 100% corresponds to single line spacing.
 - *At Least* – sets the minimum line spacing to the value entered in the box. If different font sizes are used within a paragraph, the line spacing is automatically adjusted to the largest font size. If identical spacing is required for all lines, specify a value that corresponds to the largest font size.
 - *Leading* – sets the vertical space height that is inserted between two lines.
 - *Fixed* – enter a fixed value to be used for line spacing.

Tip

Setting the line spacing to less than 100% is a good method to place a lot of text into a text box or object when space is limited. However, care must be taken as too small a value will make the text hard to read.

Tip

Change the default unit of measurement in **Tools > Options > LibreOffice Impress > General** on the Menu bar.

Asian Typography options

The **Asian Typography** page (Figure 224) is only available when **Asian** options are enabled in **Tools > Options > Language Settings > Languages** on the Menu bar. The **Line Change** options are as follows:

- *Apply list of forbidden characters to the beginning and end of lines* – prevents the characters in the list from starting or ending a line. Characters are relocated to either the previous line or the next line. To edit restricted characters that start or end a line, go to **Tools > Options > LibreOffice > Language Settings > Asian Layout** on the Menu bar.

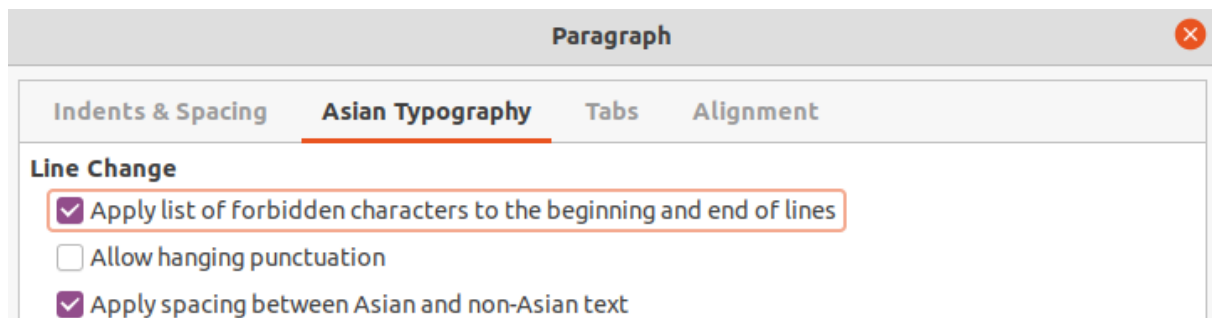

Figure 224: Paragraph dialog - Asian Typography page

- *Allow hanging punctuation* – prevents commas and periods from breaking the line. Instead, these characters are added to the end of the line, even in the page margin.
- *Apply spacing between Asian and non-Asian text* – inserts a space between Asian and non-Asian characters.

Tab options

Use the **Tabs** page (Figure 225) to create, edit, or delete the tab stops in a text box or object. The options are as follow:

- **Position** – enter a measurement in the text box to set the position of a tab in a text box. Any tabs already created are listed in the preview box below the measurement setting.
- **Type** – determines the type of tab used.
 - *Left* – aligns the left edge of the text to the tab stop and extends the text to the right. If Asian language support is enabled in LibreOffice Preferences, this tab stop is called *Left/Top*.
 - *Right* – aligns the right edge of the text to the tab stop and extends the text to the left of the tab stop. If Asian language support is enabled in LibreOffice Preferences, this tab stop is called *Right/Bottom*.
 - *Centered* – aligns the center of the text to the tab stop.
 - *Decimal* – aligns the decimal point of a number to the center of the tab stop. The numbers to the left of the decimal point are aligned to the left of the tab. The numbers to the right of the decimal point are aligned to the right of the tab.
 - *Character* – enter a character to use as a decimal separator when using decimal tabs.
- **Fill character** – specifies the type of character inserted between the tab insertion point and the tab stop.
 - *None* – no fill characters are inserted between the tab insertion point and the tab stop. It also removes any existing fill characters between the tab insertion point and the tab stop.
 - *Dots.....* – inserts dots between the tab insertion point and the tab stop.
 - *Dashes-----* – inserts dashes between the tab insertion point and the tab stop.
 - *Line_____* – draws a line between the tab insertion point and the tab stop.
 - *Character* – specify a character for insertion between the tab insertion point and the tab stop.

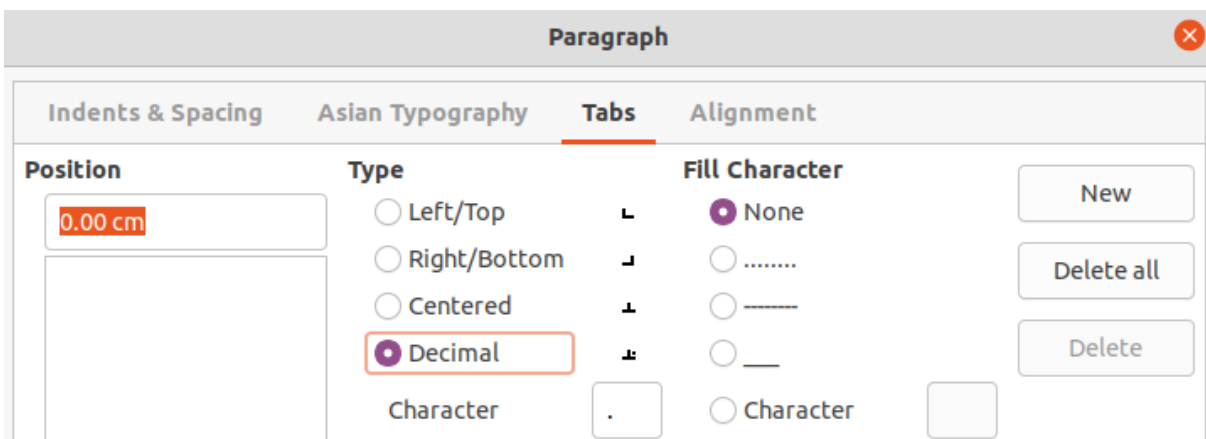

Figure 225: Paragraph dialog - Tabs page

Creating tabs

- 1) Select the text box so that the selection handles on the text box border or object are displayed.
- 2) Right-click on the selected text box or object and select **Paragraph** from the context menu or go to **Format > Paragraph** on the Menu bar to open the Paragraph dialog.
- 3) Click on **Tabs** to open the **Tabs** page in the Paragraph dialog.
- 4) Enter the position measurement for the tab stop in the **Position** text box.
- 5) Select the type of tab from the options in **Type**.

Note

If the type is set to *Decimal*, the default character used is the character used for decimal points in the computer setup. If required, specify the character to be used as the decimal point in *Character* box.

- 6) Select the type of **Fill Character**. The fill character is inserted between the tab insertion point and the tab stop.
- 7) Click on **New** to create the new tab stop in the text box. The new tab stop appears in the **Position** preview box.
- 8) Click **OK** to save the changes and close the dialog.
- 9) To use the new tab stop in more than one text paragraph in a text box or object:
 - Modify or update the drawing style used for the text.
 - Create a custom drawing style and apply it to the text.

Editing tabs

- 1) Select the text box so that the selection handles on the text box border or object are displayed.
- 2) Right-click on the selected text box or object and select **Paragraph** from the context menu or go to **Format > Paragraph** on the Menu bar to open the Paragraph dialog.
- 3) Click on **Tabs** to open the **Tabs** page in the Paragraph dialog.
- 4) Select the tab for editing in the **Position** preview box.
- 5) To change the tab position, type, or fill character, delete the selected tab first and create a new tab with the required changes.
- 6) Click **OK** to save the changes and close the dialog.
- 7) If necessary, update the drawing style used for the text.

Deleting tabs

- 1) Select the text box so that the selection handles on the text box border or object are displayed.
- 2) Right-click on the selected text box or object and select **Paragraph** from the context menu or go to **Format > Paragraph** on the Menu bar to open the Paragraph dialog.
- 3) Click on **Tabs** to open the **Tabs** page in the Paragraph dialog.
- 4) Select the tab for deletion in the **Position** preview box.
- 5) Click on **Delete** to delete the selected tab, or click **Delete All** to delete all the tab stops that are set for the selected text box or object.
- 6) Click **OK** to save the changes and close the dialog.

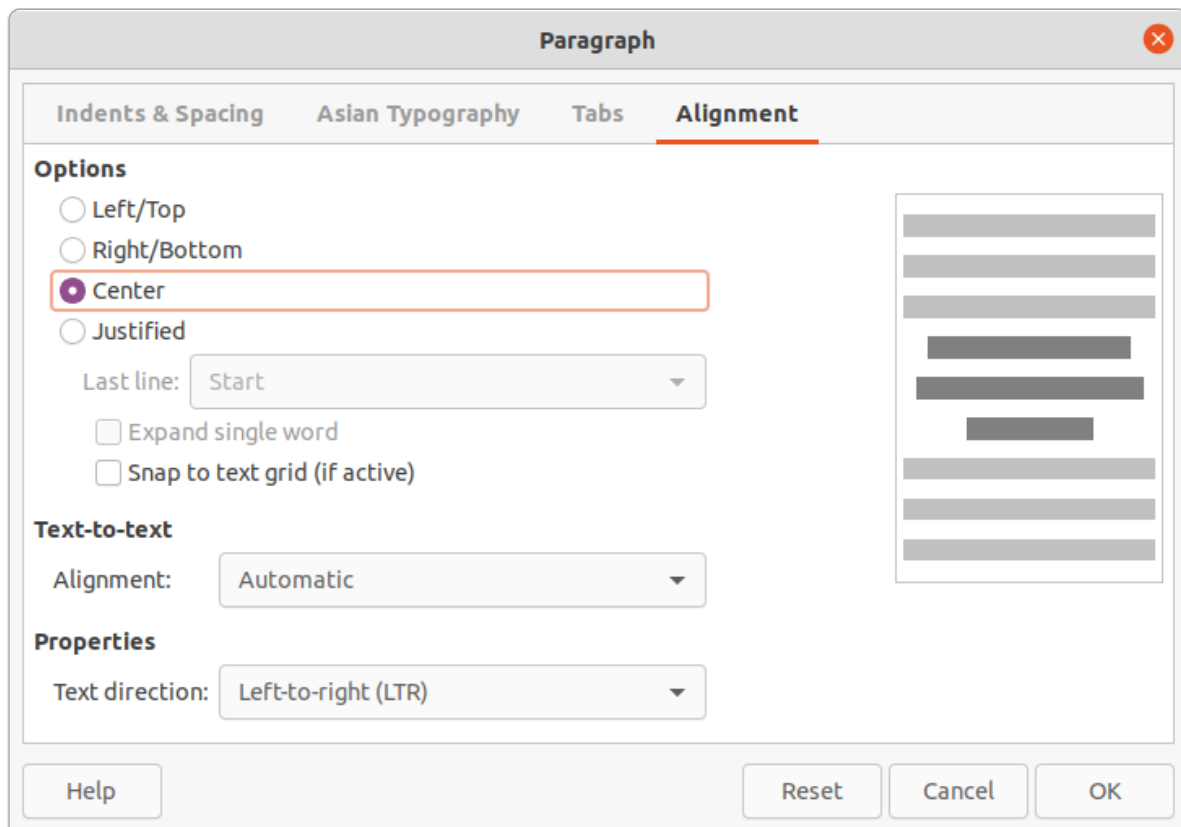

Figure 226: Paragraph dialog - Alignment page

Alignment options

Use the **Alignment** page (Figure 226) to determine the text alignment in text boxes or objects:

- **Options**
 - *Left* – aligns text to the left margin of the text box. If Asian language support is enabled, this option is named *Left/Top*.
 - *Right* – aligns text to the right margin of the text box. If Asian language support is enabled, this option is named *Right/Bottom*.
 - *Center* – aligns the text to the center of in the text box.
 - *Justified* – aligns the text to the left and to the right margins of the text box.
- **Text-to-text**
 - *Alignment* – provides alignment options for oversized or undersized characters in the text relative to the rest of the text.
- **Properties**
 - *Text direction* – specifies the text direction for text that uses Complex Text Layout (CTL) and is only available if this option is enabled.
- **Preview field** – displays a preview of how the text will appear in the text box.

Sidebar Paragraph panel

An alternative method of formatting paragraphs is to use the **Paragraph** panel (Figure 227) in the Properties deck on the Sidebar. The formatting options are limited, but are similar in use to the formatting options in the various pages of the Paragraph dialog. Any formatting applied to a paragraph using the Sidebar is immediate.

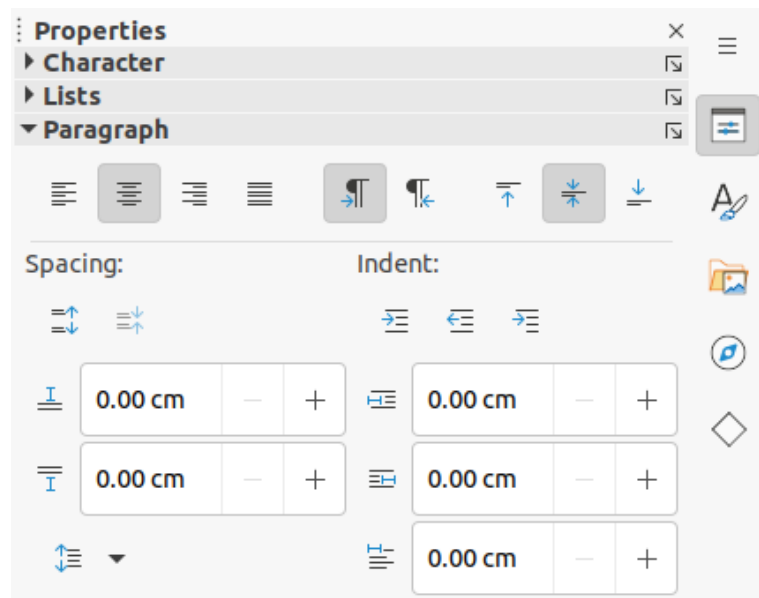

Figure 227: Paragraph panel in Properties deck on Sidebar

- 1) Click anywhere in the paragraph that is to be formatted.
- 2) On the Sidebar, click on **Properties** to open the Properties deck.
- 3) If necessary, click on the expansion symbol on the left of the **Paragraph** title bar to open the **Paragraph** panel.
- 4) Format the text using the various tools in the **Paragraph** panel. See “Paragraph dialog” on page 191 for more information on formatting options.
- 5) If necessary, click on **More Options** on the right of the title bar to open the Paragraph dialog to format text.

The text formatting options in the **Paragraph** panel in the Properties deck on the Sidebar are as follows. Most of these tools are also available on the Text Formatting toolbar.

- **Align Left, Align Center, Align Right, Justified** – determines how text is aligned to the text box or object margins.
- **Left-To-Right, Right-To-Left** – only available when **Complex Text Layout (CTL)** options have been selected in **Tools > Options > Language Settings > Languages**.
- **Align Top, Center Vertically, Align Bottom** – aligns text to the top, center or bottom of a text box or object. This is similar to vertical alignment of data within a table cell.
- **Increase Paragraph Spacing, Decrease Paragraph Spacing** – increases or decreases the spacing above and below the selected text.
- **Above Paragraph Spacing, Below Paragraph Spacing** – increases or decreases the spacing either above or below selected text. Enter the amount of spacing required in the text box.
- **Set Line Spacing** – adjust the spacing between the lines of selected text. Click on the triangle ▼ to the right of the icon and select the type of line spacing required from the drop-down list.
- **Increase Indent, Decrease Indent** – each click increases or decreases the indent level of selected text by the default value for Draw. To specify indent measurements, enter a value in *Before Text Indent*, *After Text Indent* or *First Line Indent* boxes.
- **Hanging Indent** – sets a different indent for the first line of text to the indent set for a whole paragraph of text as follows:
 - Enter a negative value in *First Line Indent* to reduce the indent of the first line of text.

- Enter a positive value in *First Line Indent* to increase the indent of the first line of text.
- First click sets a negative hanging indent and a second click sets a positive hanging indent.
- This tool is only active when a *Before text* indent has been set for the paragraph of text.
- To remove a hanging indent, set the value in the *First line* box to zero.

Character formatting

Direct or manual character formatting can be applied to individual characters and words. Direct character formatting overrides any formatting that has been applied using direct text formatting and drawing styles.

- 1) Select the characters for formatting, see “Selecting text” on page 191 for more information.
- 2) Format characters using one of the following methods.
 - Various formatting tools on the Text Formatting toolbar. Formatting applied to character(s) is immediate.
 - Go to **Format** on the Menu bar. Selecting a formatting option opens either a context menu or dialog where further formatting options are selected.
 - Use the options available in the Character dialog. Clicking **OK** on the dialog applies the formatting changes.
 - Use the options available in the **Character** panel in the Properties deck on the Sidebar. Formatting applied to character(s) is immediate.
- 3) Click outside the text box or object to deselect the text.

Character dialog

- 1) Select the characters for formatting and open the Character dialog (Figure 228) using one of the following methods:
 - Right-click on the characters and select **Character** from the context menu.
 - Go to **Format > Character** on the Menu bar.
- 2) Use the options on the tabbed pages of the Character dialog to format the selected characters.
- 3) Click **OK** to apply the formatting changes and close the dialog.
- 4) Click outside the text box or object to deselect the text.

Fonts options

In **Western Text Font** on the **Fonts** page (Figure 228), select the font family, typeface (*Italic*, **Bold**, and so on), size, and language. A sample of the font is displayed in the preview box in the lower part of the dialog.

If support for Asian language or Complex Text Layout (CTL) has been enabled in **Tools > Options > Language Settings > Languages**, then character formatting options are also available for **Asian Text Font** or **CTL Font**.



Note

The number of typefaces available depends on the font family that is selected.

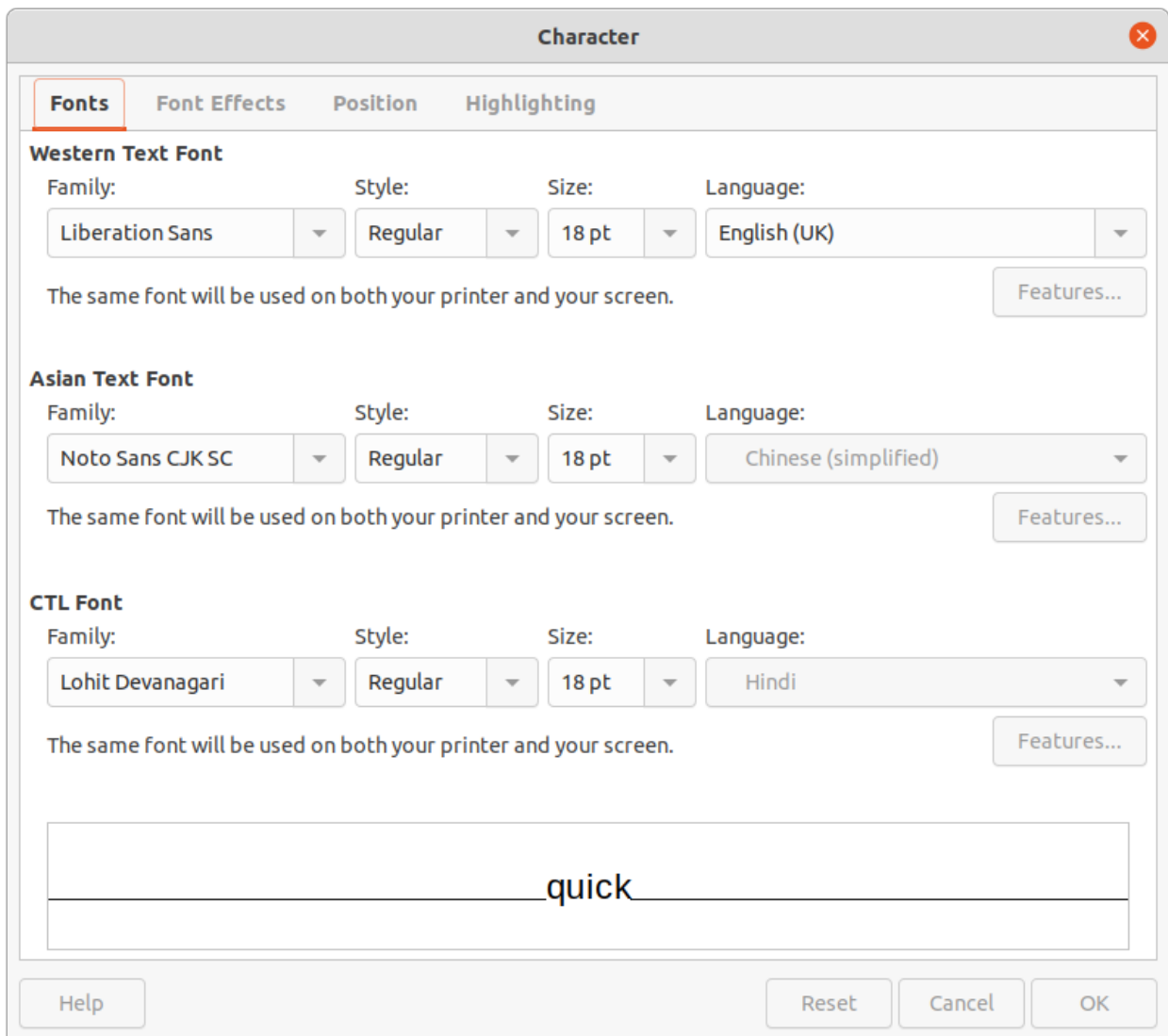

Figure 228: Character dialog - Fonts page

i Tip

When creating a drawing in multiple languages, use the language setting to create styles that only differ in the language in formatting attributes. This allows for spelling checks of all of the drawing contents without affecting appearance.

Font Effects options

The options on the **Font Effects** page (Figure 229) apply font color, text decoration and effects to the selected text or characters. A sample of the font effect is displayed in the preview box in the lower part of the dialog.

- **Font Color**
 - *Font color* – sets the color for the selected text. Select a color from one of the available palettes. If *Automatic* is selected, the text color is set to black for light backgrounds and to white for dark backgrounds.
 - *Transparency* – sets the transparency of the selected text. Enter a value in the text box. 100% entirely transparent, 0% no transparency.

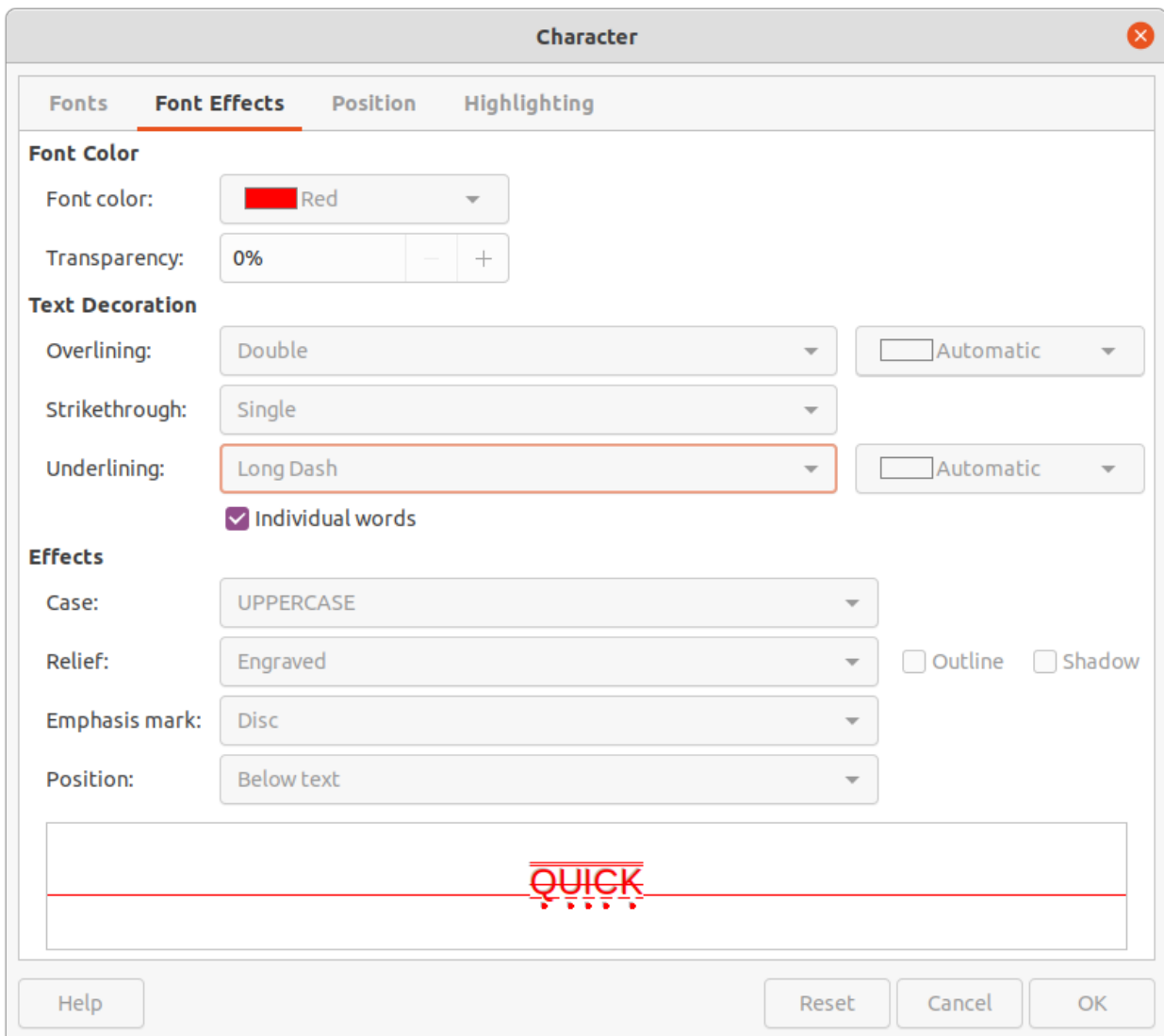

Figure 229: Character dialog - Font Effects page

- **Text Decoration**

- *Overlining* – select the over lining style from the drop-down list and the over lining color from one of the available palettes. If *Automatic* is selected, the color is set to black for light backgrounds and to white for dark backgrounds.
- *Strikethrough* – select a strikethrough style for the selected text.
- *Underlining* – select the underlining style from the drop-down list and the underlining color from one of the available palettes. If *Automatic* is selected, the color is set to black for light backgrounds and to white for dark backgrounds.
- *Individual words* – when selected, any over lining or underlining is applied to words only and spaces are ignored.

- **Effects**

- *Case* – select a capitalization effect from the drop-down list.
- *Relief* – select a relief effect for the selected text. Embossed relief makes the characters appear as if they are raised above the page. Engraved relief makes the characters appear as if they are pressed into the page.
- *Emphasis mark* – select a character to display over or below the entire length of the selected text.

- *Position* – specifies where to display the emphasis marks. Either above the text or below the text.

Position options

The options on the **Position** page (Figure 230) allows setting of the position, scaling, and spacing of selected text.

- **Position** – sets the subscript or superscript options for a character.
 - *Normal* – removes superscript or subscript formatting.
 - *Superscript* – reduces the font size of the selected text and raises the text above the baseline.
 - *Subscript* – reduces the font size of the selected text and lowers the text below the baseline.
 - *Raise/lower by* – enter the amount to raise or to lower the selected text in relation to the baseline. 100% is equal to the height of the font.
 - *Relative font size* – enter the amount to reduce the font size of the selected text.
 - *Automatic* – sets the amount by which the selected text is automatically raised or lowered in relation to the baseline.
- **Scaling**
 - *Scale width* – enter a percentage of the font width to horizontally stretch or compress the selected text.
- **Spacing** – specifies the spacing between individual characters.
 - *Character spacing* – specifies the spacing between the characters of the selected text. Enter the amount to expand or condense the text in the text box or object. To increase spacing, set a positive value; to reduce spacing, set a negative value.
 - *Pair kerning* – automatically adjusts the character spacing for specific letter combinations. Kerning is only available for certain font types and requires printer support for this option.

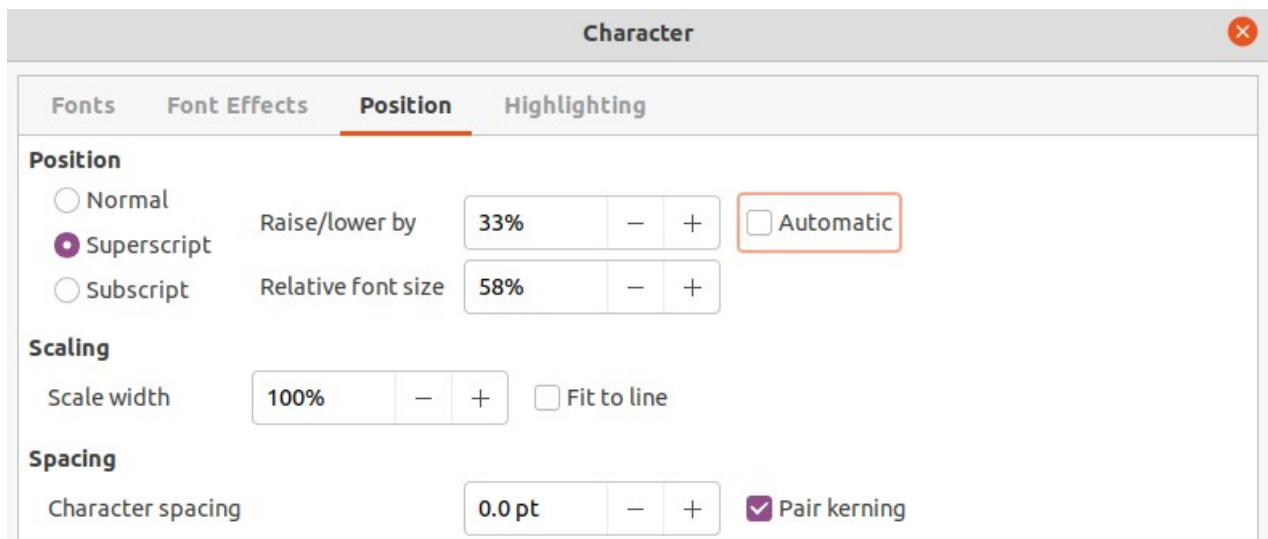

Figure 230: Character dialog - Position page

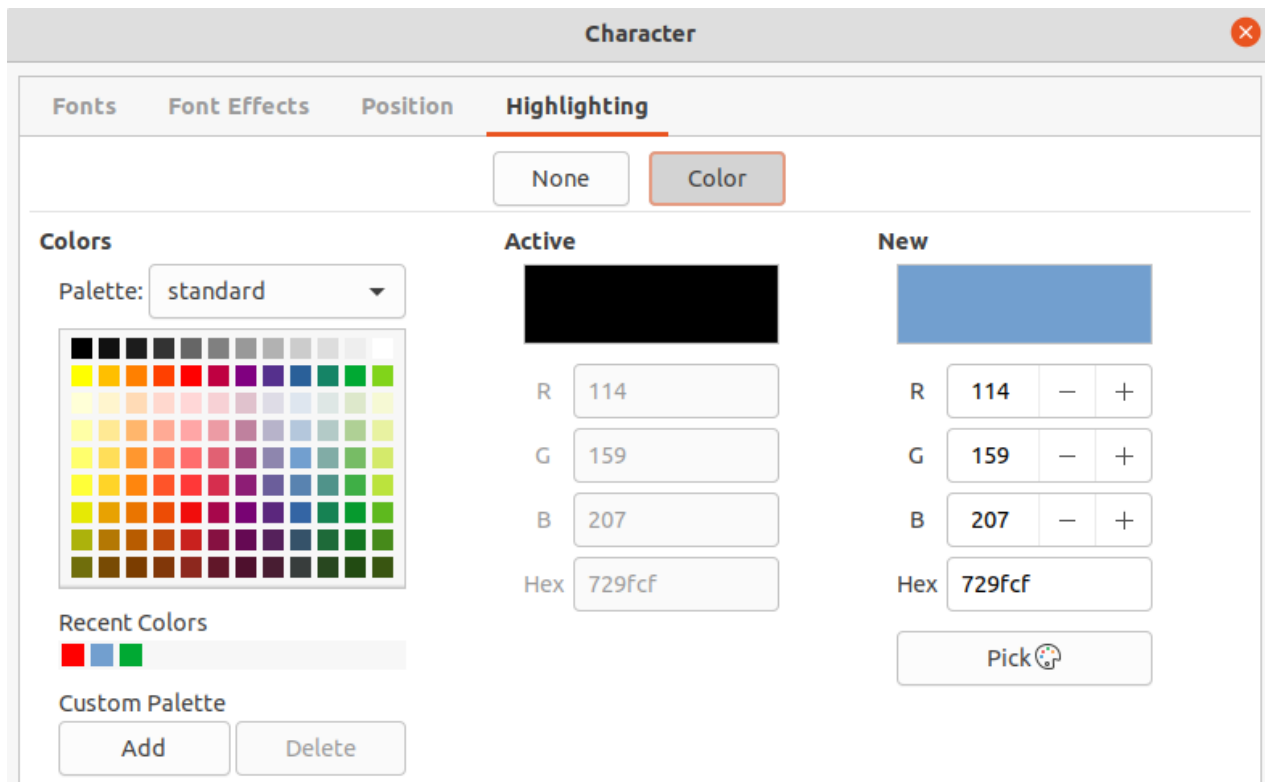

Figure 231: Character dialog - Highlighting page

Highlighting options

The options on the **Highlighting** page (Figure 231) allows highlighting of text so that the characters are different color to the rest of the text in the text box or object.

- **Colors** – select a highlight color from one of the available palettes.
- **Active** – shows the present color of the text and the Red, Green and Blue (RGB) settings for the present color.
- **New** – shows the highlight color of the text that has been selected in **Colors** and the Red, Green and Blue (RGB) settings for the new color. The color can also be selected by changing the values in the RGB boxes or using the Pick a Color dialog when **Pick** is selected.

Sidebar Character panel

An alternative method of formatting text is to use the **Character** panel (Figure 232) in the Properties deck on the Sidebar. The formatting options available in the **Character** panel are limited, but are similar in use to the formatting options available in the various pages of the Character dialog. Most of the options are also available on the Text Formatting toolbar.

- 1) Select a text box or object so that the selection handles on the border are displayed.
- 2) On the Sidebar, click on **Properties** to open the Properties deck.
- 3) Click on the expansion symbol on the left of the **Character** title bar to open the *Character* section.
- 4) Format the text using the tools in the **Character** panel. See “Character dialog” on page 198 for more information on formatting options.
- 5) If necessary, click on **More Options** on the right of the title bar to open the Character dialog to format text.

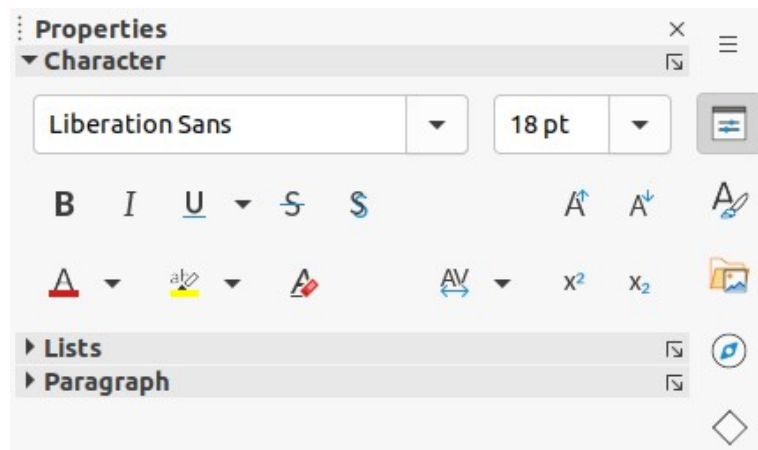

Figure 232: Character panel in Properties deck on Sidebar

The text formatting options available in the **Character** panel in the Properties deck on the Sidebar are as follows:

- **Font Name** and **Font Size** – select the font family and size from the drop-down lists.
- **Bold** and **Italic** – applies a **bold** or *italic* typeface to the selected text.
- **Underline** – underlines the selected text. Click on the triangle ▼ to the right and select the type of underlining from the drop-down list. Click **More Options** at the bottom of this drop-down list to open the Character dialog.
- **Strikethrough** – draws a line through the selected text.
- **Toggle Shadow** – adds a shadow to the selected text.
- **Increase Font Size** and **Decrease Font Size** – each click increases or reduces the size of the selected characters by the same amount. Actual size depends on the computer setup.
- **Font Color** and **Character Highlight Color** – click on the triangle ▼ to the right of these icons and select a color from the available palettes.
- **Set Character Spacing** – click on the triangle ▼ to the right of this tool and select the type of spacing between characters required. Spacing between characters is also known as kerning. A custom value for character spacing can also be set.
- **Superscript** – reduces the font size of the selected text and raises the text above the baseline.
- **Subscript** – reduces the font size of the selected text and lowers the text below the baseline.

Bullet or numbered lists

Bulleted and numbered lists can be created in text boxes and objects. However, when creating lists in objects, please remember that Draw objects are not dynamic and do not automatically expand as a list is created.

✓ Note

Creating bulleted or numbered lists in Draw is similar to LibreOffice Writer, but the functionality in Draw has been reduced.

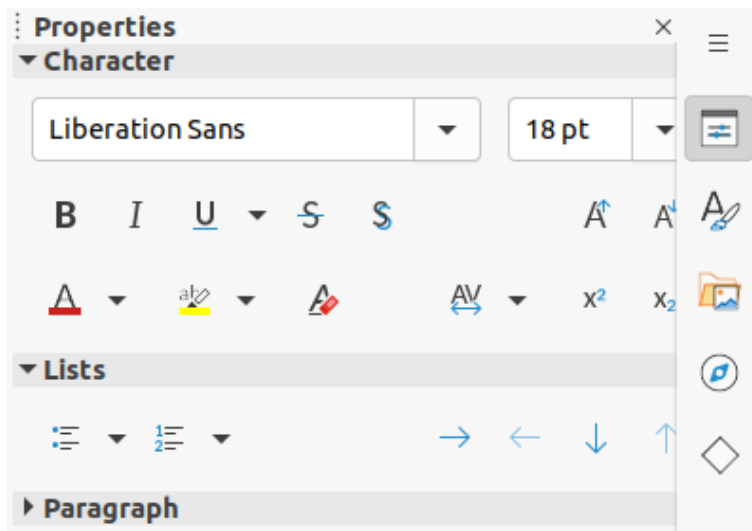

Figure 233: Lists panel in Properties deck on Sidebar

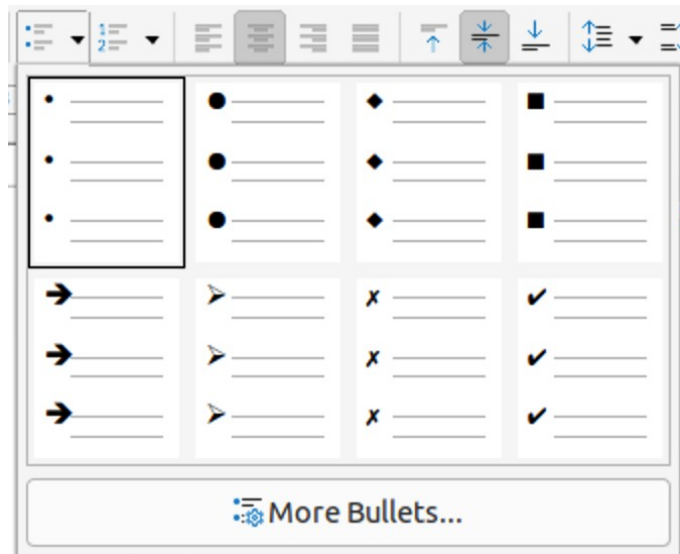

Figure 234: More Bullets list

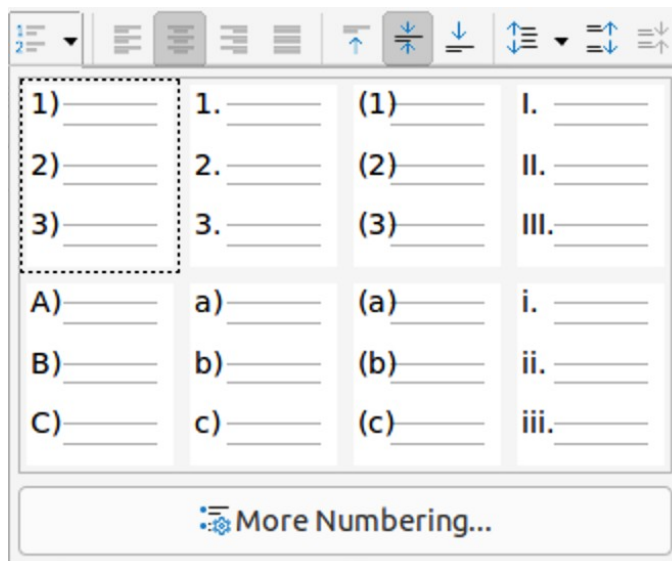

Figure 235: More Numbering lists

Creating lists

Bulleted or numbered lists can be created in text boxes or Draw objects as follows:

- 1) Select all of the text required for a list.
- 2) Create a list using one of the following methods and default settings for lists:
 - Click on **Toggle Unordered List** or **Toggle Ordered List** on the Text Formatting toolbar.
 - Click on **Toggle Unordered List** or **Toggle Ordered List** in the **Lists** panel in the Properties deck on the Sidebar (Figure 233).
 - Go to **Format > Lists > Unordered List** or **Ordered List** on the Menu bar.
- 3) To change the format of the list, click on the triangle ▼ on the right of the list icons and select a list style from the options available in the pop-up More Bullets dialog (Figures 234) or More Numbering dialog (Figure 235).

Adjusting list item level and position

Each item in an unordered or ordered list can have its level demoted or promoted within a list, or moved up or down in list order as follows:

- 1) Click on a list item to demote, promote, or move up or down.
- 2) To demote a list item one level at a time, use one of the following methods:
 - Use the *Tab* key.
 - Go to **Format > Lists > Demote** on the Menu bar.
 - Use **Demote** in the **Lists** panel in the Properties deck on the Sidebar.
- 3) To promote a list item one level at a time, use one of the following methods:
 - Use the key combination *Shift+Tab*.
 - Go to **Format > Lists > Promote** on the Menu bar.
 - Use **Promote** in the **Lists** panel in the Properties deck on the Sidebar.
- 4) To change the position of a list item in the list order, use one of the following methods:
 - Go to **Format > Lists > Move Up** or **Move Down** on the Menu bar.
 - Use **Move Up** or **Move Down** in the **Lists** panel in the Properties deck on the Sidebar.

Bullets and Numbering dialog

Use the Bullets and Numbering dialog (Figure 236) for more control over the format of a list. Select text in a text box or object and open the dialog using one of the following methods:

- Go to **Format > Bullets and Numbering** on the Menu bar.
- Right-click on the selected text and select **Bullets and Numbering** from the context menu.
- Click on **More Options** on the right side of **Lists** panel title bar in the Properties deck on the Sidebar.
- Click on **More Bullets** or **More Numbering** after clicking on the triangle ▼ on the right of **Toggle Unordered List** or **Toggle Ordered List** on the Text Formatting toolbar or in the **Lists** panel in the Properties deck on the Sidebar.

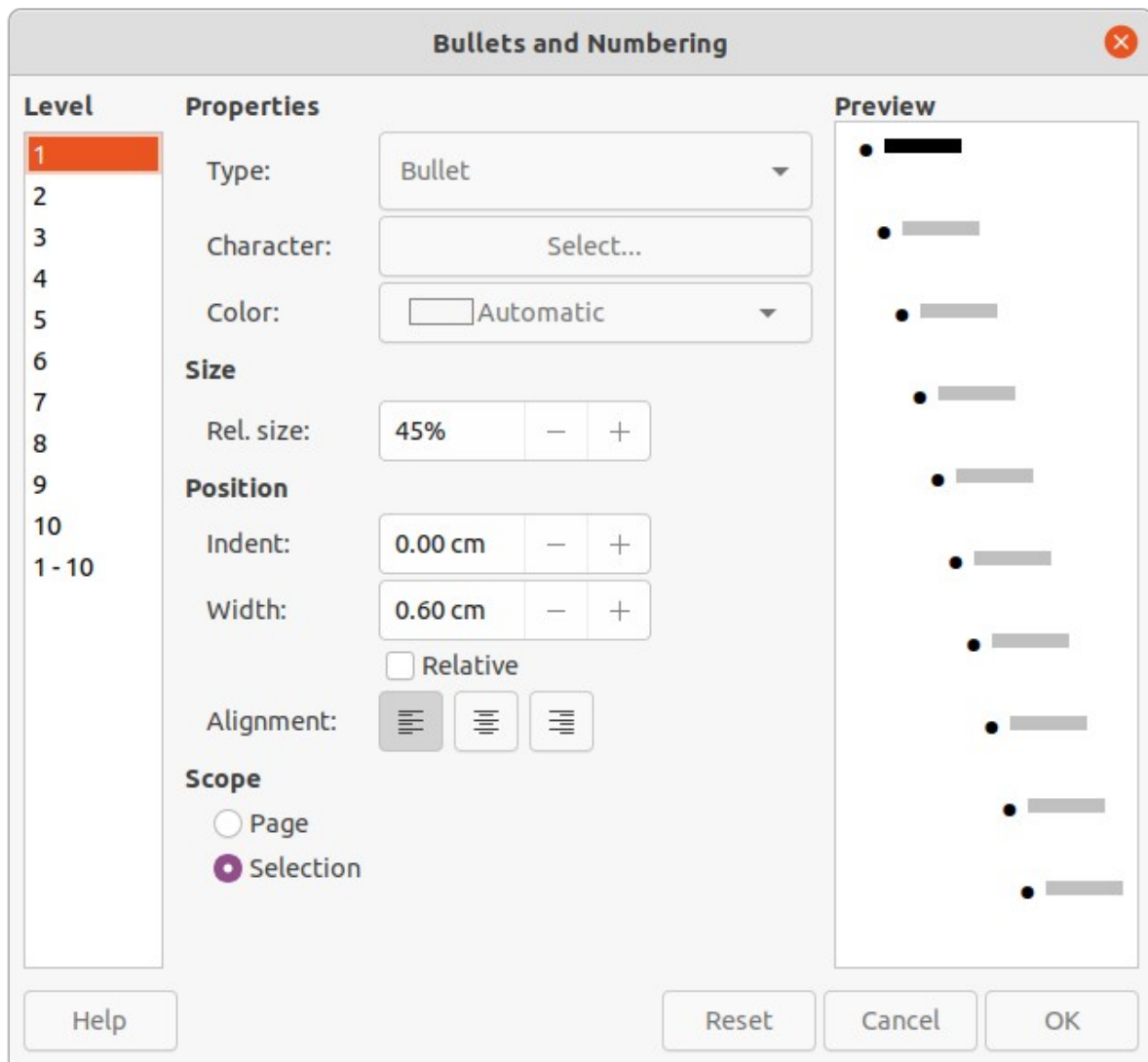

Figure 236: Bullets and Numbering dialog

The following options are available in the Bullets and Numbering dialog.

- **Level** – select the level(s) required to define the formatting options for a list. The selected levels are highlighted in the preview.
- **Properties**
 - *Type* – select the style for the list indicator from the drop-down list. When *Graphic* is selected as *Type*, select an image from a file or the Gallery.
 - *Character* – when *Bullet* is selected as *Type*, select the character from the Special Characters dialog that opens.
 - *Color* – select a color for the list indicator from the palettes available.
 - *Start at* – when a numeric style list is selected in *Type*, enter a starting number for the current level. Default starting number is 1.
- **Separator** – this option becomes available when a numeric style list is selected in *Type*.
 - *Before* – enter a character or text to display in front of the number in the list. For example, to create a list that uses the style (1, enter (in this box.
 - *After* – enter a character or text to display behind the number in the list. For example, to create a list that uses the style A), enter) in this box.

- **Size**
 - *Rel. Size* – enter a percentage amount to resize the list indicator in relation to the font height of the current list.
 - *Width* – only available when *Graphic* is selected as *Type*. Enter a width for the graphic.
 - *Height* – only available when *Graphic* is selected as *Type*. Enter a height for the graphic.
 - *Keep ratio* – only available when *Graphic* is selected as *Type*. Maintains the size proportions of the graphic.
- **Position**
 - *Indent* – sets the indent measurement of the list point and the margin.
 - *Width* – set the indent measurement of the between the list indicator and the text in the list point. For example, this option is useful when large numbers are used in a list.
 - *Relative* – select this option to measure the indent value relative to the previous level and not from the margin.
 - *Alignment* – sets the paragraph alignment for the list indicator.
- **Scope**
 - *Page* – applies the changes to the drawing.
 - *Selection* – applies the changes only to the selected text.
- **Preview** – displays how the list will look when changes to the format are used.

Text columns

Text in a drawing can be formatted into columns inside text boxes and objects. However, columns cannot be used on separate parts of text inside a text box or object. The whole of the text box or object has to be used for columns.

The type of columns used in Draw are continuous flow columns. This means that when text reaches the bottom of a column it will automatically flow into the next column as text is added. This type of columns is also known as newspaper columns.

Text boxes

- 1) Click the border of a text box to select it so that the selection handles are displayed indicating that the text box is in edit mode.

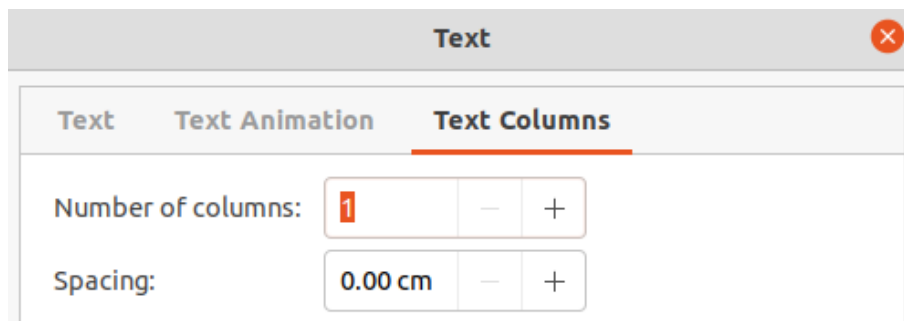

Figure 237: Text dialog - Text Columns page

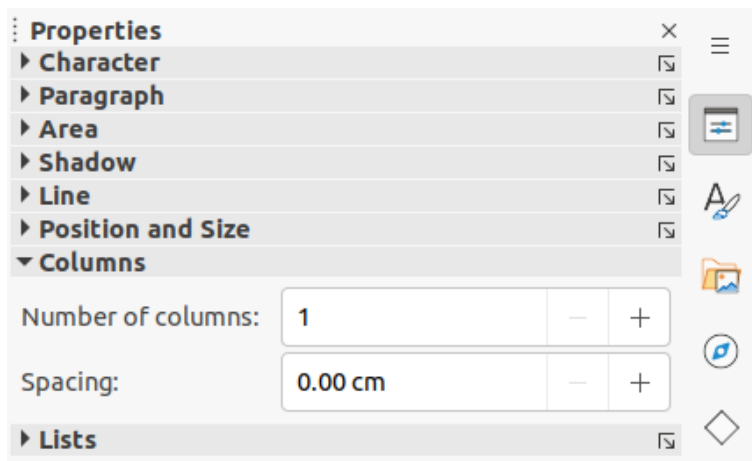

Figure 238: Columns panel in Properties deck on Sidebar

- 2) Open the options for text columns using one of the following methods:
 - Right-click in the text box and select **Text Attributes** from the context menu to open the Text dialog, then click on the **Text Columns** tab to open the **Text Columns** page (Figure 237),
 - Click on **Columns** in Properties on the Sidebar to open the **Columns** panel (Figure 238).
- 3) Set the number of columns required in the *Number of columns* box and the required spacing between the columns in the *Spacing* box.
- 4) Save the changes and deselect the text box using one of the following methods:
 - For the Text dialog, click **OK** to save the changes and close the dialog, then click outside the text box to deselect it.
 - For the **Columns** panel in the Properties deck on the Sidebar, click outside the text box to deselect it and save the changes.

✓ Note

Any text inside a text box or drawing object will automatically flow into column format when the changes are saved.

Drawing objects

- 1) Click on an object to select it so that the selection handles are displayed indicating that the object is in edit mode.
- 2) Double-click on the selected object to switch on text edit mode.
- 3) Open the options for text columns using one of the following methods:
 - Right-click in the drawing object and select **Text Attributes** from the context menu to open the Text dialog, then click on the **Text Columns** tab to open the **Text Columns** page (Figure 237),
 - Click on **Columns** in Properties on the Sidebar to open the **Columns** panel (Figure 238).
- 4) Set the number of columns required in the *Number of columns* box and the required spacing between the columns in the *Spacing* box.
- 5) Save the changes and deselect the object using one of the following methods:
 - For the Text dialog, click **OK** to save the changes and close the dialog, then click outside the object to deselect it.

- For the **Columns** panel in the Properties deck on the Sidebar, click outside the object to deselect it and save the changes.
- 6) Double-click again on the object to switch on text edit mode.
 - 7) Type in the required text or use copy and paste to enter the required text. Any text entered will be in column format.
 - 8) If necessary, format the text to the drawing requirements.
 - 9) Click outside the object to deselect it and save the changes.

Using tables

Tables are a powerful mechanism to convey structured information quickly when used in a drawing. Tables can be added directly to a drawing eliminating the need to embed a Calc spreadsheet or a Writer text table. However, in some circumstances, it makes sense to embed a spreadsheet into a drawing, especially when greater functionality is required in the table. The tables provided by Draw do have a limited functionality.

Inserting tables

Tables are placed at the center of a drawing and cannot be placed into objects or shapes. Also, unlike text boxes and other objects, tables cannot be rotated.

- 1) To create and insert a table using the Insert Table dialog (Figure 239):
 - a) Go to **Insert > Table** on the Menu bar to open the Insert Table dialog.
 - b) Enter the number of rows and columns required.
 - c) Click **OK** to insert the table into the center of a drawing and close the dialog.
- 2) Alternatively, to create and insert a table using the Table grid (Figure 240):
 - a) Click on **Table** on the Standard toolbar to open the Table grid.
 - b) Click and drag the cursor until the required number of columns and rows are selected,
 - c) Click again to insert the table into the center of a drawing and close the Table grid.
 - d) If necessary, click on **More Options** to open the Insert Table dialog to select the number of rows and columns required.
- 3) Move the table into position by clicking on the border and dragging it to its new position.

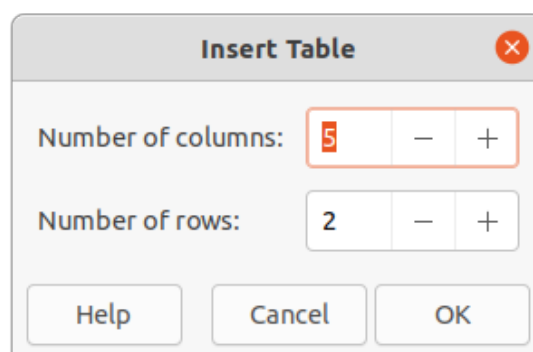

Figure 239: Insert Table dialog

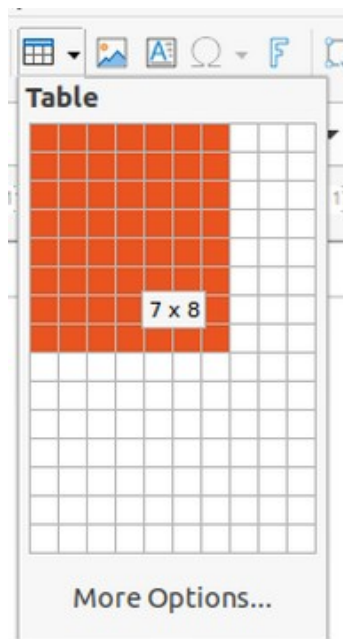

Figure 240: Table grid

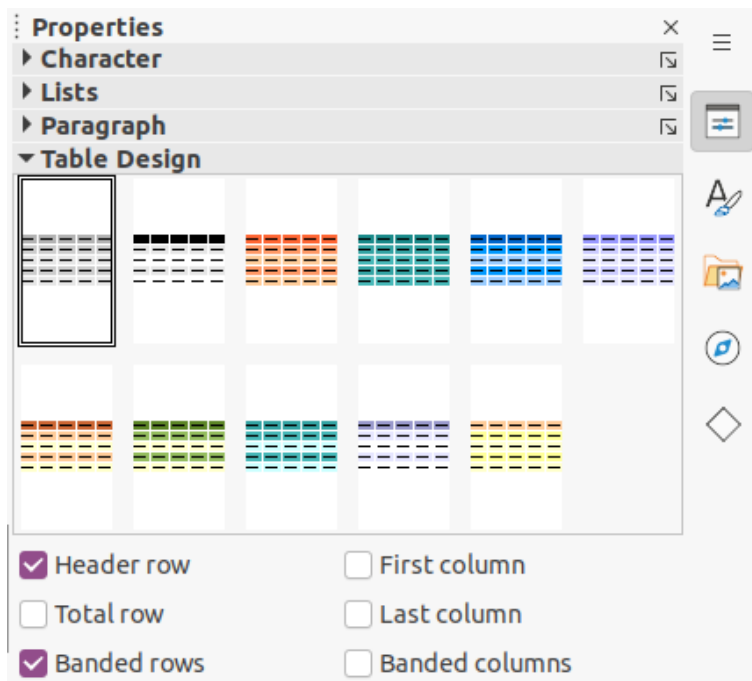

Figure 241: Table Design panel in Properties deck on Sidebar

✓ Note

When inserting tables into a drawing, the table is created using the default style with settings already applied. Currently these defaults are hard coded in LibreOffice. The table can be formatted to the drawing requirements after insertion.

Table Design panel

Several predefined table designs are provided in the **Table Design** panel in the Properties deck on the Sidebar (Figure 241). The **Table Design** panel is only available when a table is selected.

- 1) Insert a table into a drawing or select a table in a drawing.

- 2) Click on **Table Design** in the Properties deck on the Sidebar to open the *Table Design* panel, or click on **Table Design** on the Table toolbar.
- 3) Select a design for the table and the types of rows and columns from the available options.

The following options for rows and columns are available in the *Table Design* panel:

- **Header row** – selected by default. The first row is normally a header row and is displayed with a different background from the rest of the table.
- **Total row** – if selected, changes the background of the last row to make it stand out from other rows.
- **Banded rows** – selected by default. Alternate rows have different backgrounds making it easier to read data entered into the rows.
- **First column** – when selected, highlights the first column of the table using a darker background.
- **Last column** – when selected, highlights the last column of the table using a darker background.
- **Banded columns** – when selected, alternate columns are highlighted with dark and light colors.

Table formatting

After inserting a table, it can be formatted using the tools and options available on the Table toolbar, by going to **Format > Table** on the Menu bar, or using the options available in the Table Properties dialog.

Table toolbar

The Table toolbar (Figure 242) automatically opens when a table is selected providing tools for creating and formatting a table. The default position for the toolbar, when it is first opened, is docked at the bottom of the Workspace.

- **Table** – inserts a new table in a drawing using the Insert Table dialog or the Table grid. See “Inserting tables” above for more information on inserting tables.
- **Border Style** – changes the line style of the borders of selected cells. Click on the triangle ▼ next to the icon to open a drop-down list and select from a range of predefined styles.
- **Border Color** – changes the color of the borders of selected cells. Click on the triangle ▼ next to the icon to open access to the LibreOffice color palettes. Select a color from a range of predefined palettes or create a custom color.
- **Borders** – selects a predefined border configuration for the selected cells. Click on the triangle ▼ next to the icon to open a drop-down list to select a border configuration.

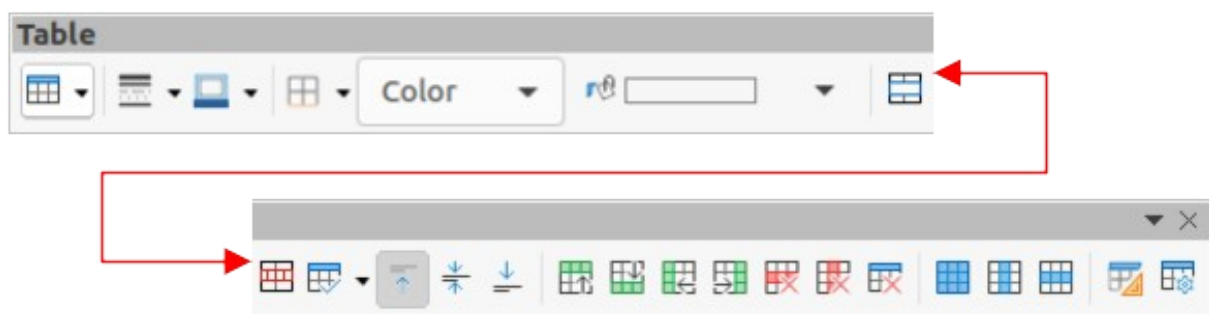

Figure 242: Table toolbar

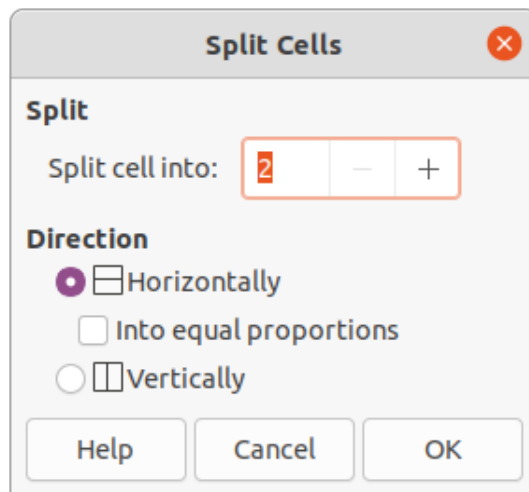

Figure 243: Split Cells dialog

- **Area Style/Filling** – select the cells to be filled, then select the type of fill from the drop-down list: *None, Color, Gradient, Hatching, Bitmap* or *Pattern*.
- **Fill Color** – select a fill option from the drop-down menu. The fill options change to show the fillings available for each **Area Style/Filling** type.
- **Merge Cells** – merges the selected cells into one cell. Note that the contents of the merged cells are also merged. Alternatively, right-click on selected cells and select **Merge Cells** from the context menu.
- **Split Cells** – splits a selected cell into multiple cells either horizontally or vertically. Make sure that the cursor is positioned on the cell, then click on **Split Cells** to open the Split Cells dialog (Figure 243).

In the Split Cells dialog, select the number of cells required when splitting a cell and whether to split the cell horizontally or vertically. If necessary, when splitting horizontally, select *Into equal proportions* to create cells of equal size. The contents of the split cell are kept in the original cell (left or top cell).

- **Optimize** – evenly distributes the selected rows and columns in a table either horizontally or vertically. Clicking on **Optimize** opens the Optimize toolbar (Figure 244) which contains the following tools:

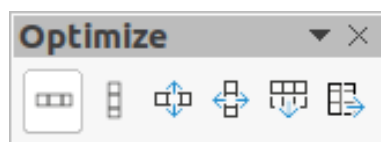

Figure 244: Optimize toolbar

- *Minimal Row Height* – determines the minimal row height for selected rows. Minimal row height depends on the font size of the smallest character in the row.
- *Minimal Column Width* – defines the minimal column width for selected columns. Minimal column width depends on the shortest entry within a column.
- *Optimal Row Height* – determines the optimal row height for selected rows. Optimal row height depends on the font size of the largest character in the row.
- *Optimal Column Width* – defines the optimal column width for selected columns. Optimal column width depends on the longest entry within a column.
- *Distribute Rows Equally* – adjusts the height of the selected rows to match the height of the tallest row in the selection.

- *Distribute Columns Evenly* – adjusts the width of the selected columns to match the width of the widest column in the selection. The total width of the table cannot exceed the width of the page.
- **Align Top, Center Vertically, Align Bottom** – sets the vertical alignment of text in selected cells.
- **Insert Row Above, Insert Row Below** – click in a cell or cells to select rows and use these two tools to insert a row or rows above or below the selected rows. Alternatively, right-click on the selected rows and select **Insert > Insert Row Above** or **Insert Row Below**.
- **Insert Column Before, Insert Column After** – click in a cell or cells to select columns and use these two tools to insert a column or columns before or after the selected columns. Alternatively, right-click on the selected columns and select **Insert > Insert Column Before** or **Insert Insert Column After**.
- **Delete Row, Delete Column, Delete Table** – click in a cell or cells to select rows or columns, then click on a tool to delete the selected rows or columns. To delete the whole table, place the cursor in a cell and select **Delete Table**. Alternatively, right-click on the selected cells and select **Delete > Delete Row** or **Delete Column** or **Delete Table** from the context menu.
- **Select Table, Select Column, Select Row** – select a table, column, or row if the same attributes are going to be applied to a table, column, or row.
- **Table Design** – click on this tool and open the **Table Design** panel in the Properties deck on the Sidebar. See “Table Design panel” on page 210 for more information.
- **Table Properties** – click on this tool and open the Table Properties dialog. Alternatively, right-click on the table and select **Table Properties** from the context menu.

Menu bar

Table formatting tools are also available by going to **Format > Table** on the Menu bar and selecting a formatting option from the submenu that opens.

- **Minimal Row Height** – determines the minimal row height for selected rows. Minimal row height depends on the font size of the smallest character in the row.
- **Optimal Row Height** – determines the optimal row height for selected rows. Optimal row height depends on the font size of the largest character in the row.
- **Distribute Columns Evenly** – adjusts the width of the selected columns to match the width of the widest column in the selection. The total width of the table cannot exceed the width of the page.
- **Select Row** – selects the row or rows where cells have been selected in the table.
- **Insert Rows** – inserts rows in the table where cells have been selected in the table.
- **Delete Row** – deletes rows in the table where cells have been selected in the table.
- **Minimal Column Width** – defines the minimal column width for selected columns. Minimal column width depends on the shortest entry within a column.
- **Optimal Column Width** – defines the optimal column width for selected columns. Optimal column width depends on the longest entry within a column.
- **Distribute Columns Evenly** – adjusts the width of the selected columns to match the width of the widest column in the selection. The total width of the table cannot exceed the width of the page.
- **Select Column** – selects the column or columns where cells have been selected in the table.

- **Insert Columns** – inserts columns in the table where cells have been selected in the table.
- **Delete Column** – deletes columns in the table where cells have been selected in the table.
- **Merge Cells** – merges the selected cells into one cell. Note that the contents of the merged cells are also merged. Alternatively, right-click on selected cells and select **Merge Cells** from the context menu.
- **Split Cells** – splits a selected cell into multiple cells either horizontally or vertically. Make sure that the cursor is positioned on the cell, then click on **Split Cells** to open the Split Cells dialog.
- **Delete Table** – to delete the whole table, place the cursor in a cell and select **Delete Table**. Alternatively, right-click on the selected cells and select **Delete Table** from the context menu.
- **Select...** – selects the whole table.
- **Properties...** – opens the Table Properties dialog.

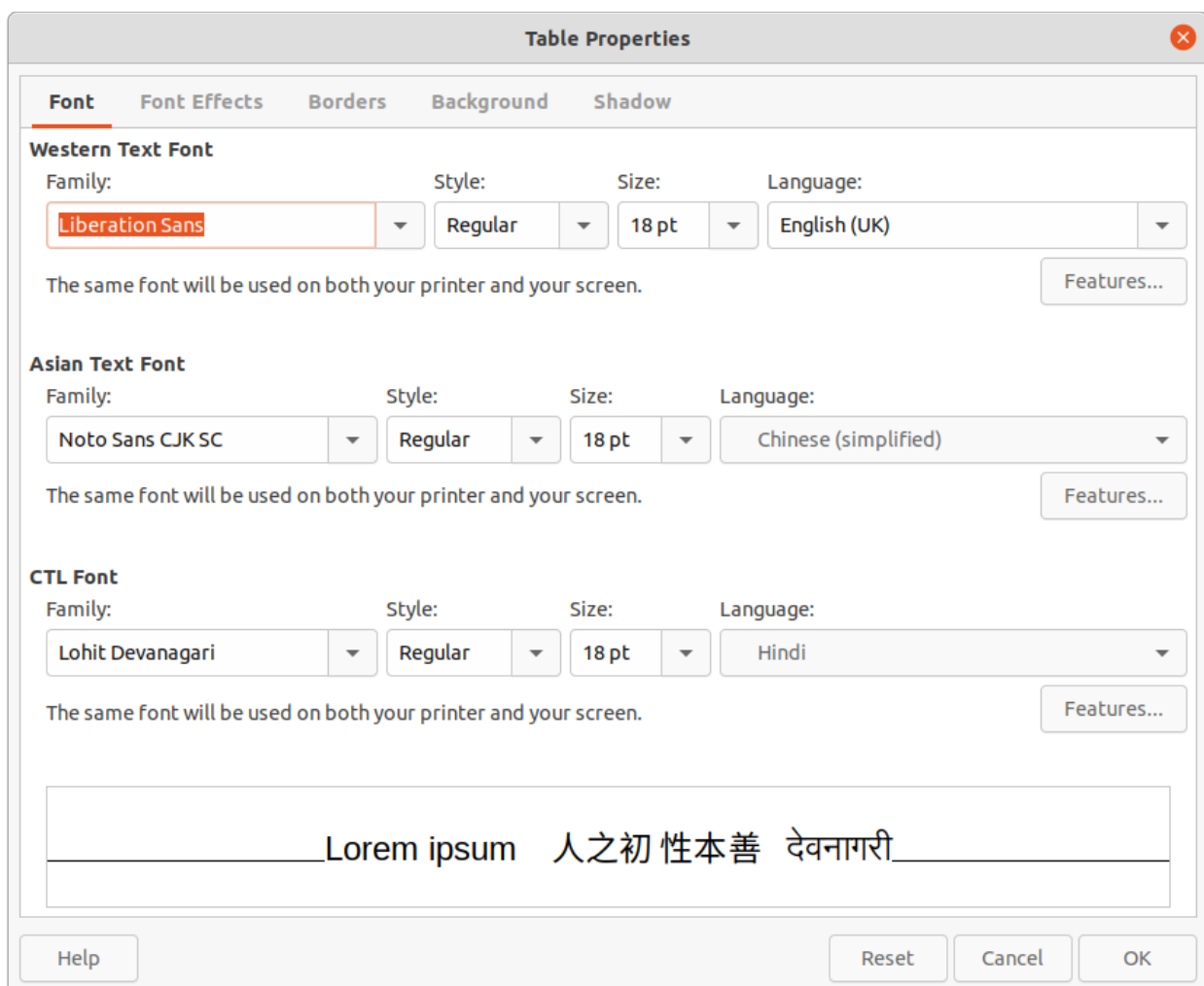

Figure 245: Table Properties dialog - Font page

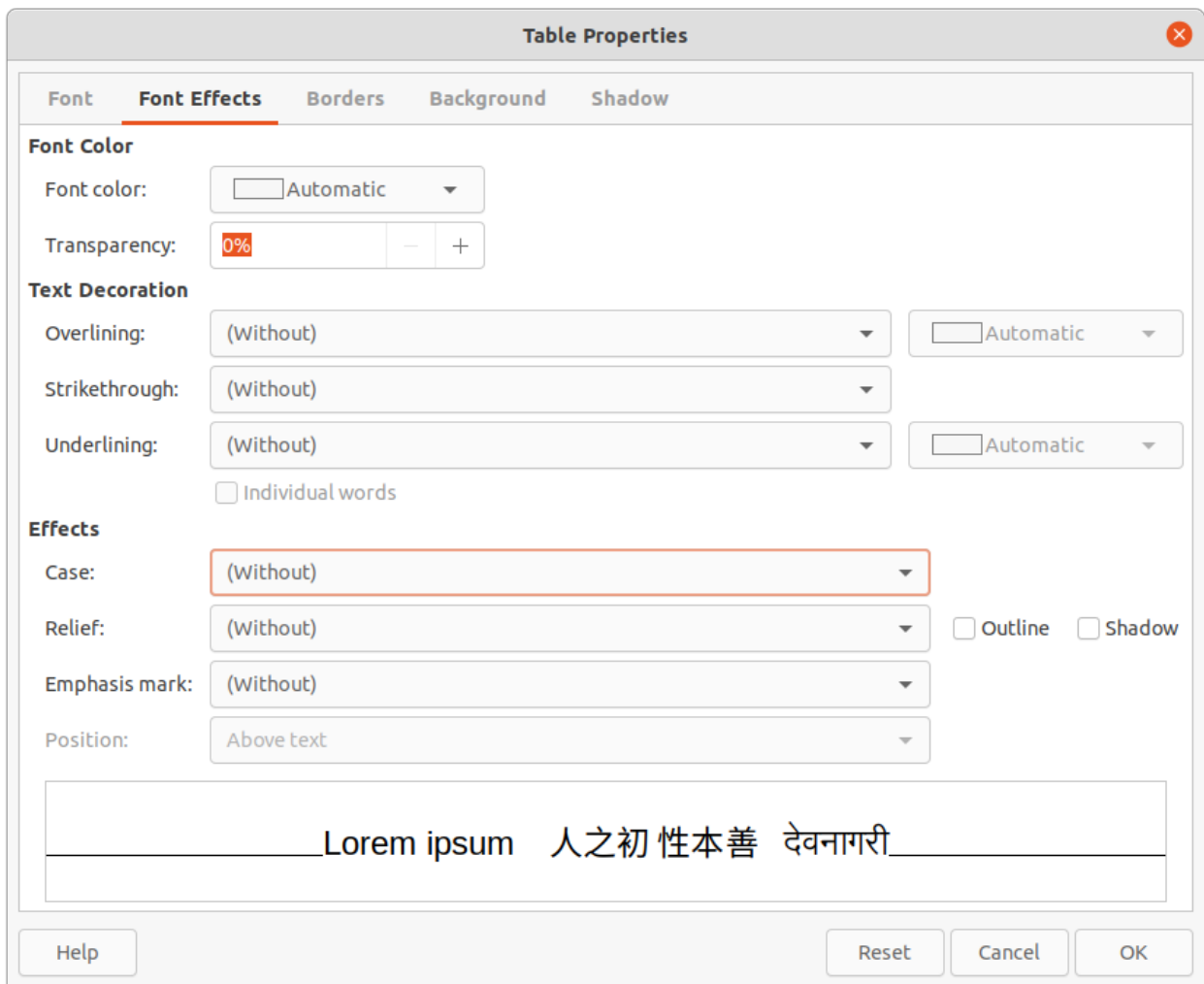

Figure 246: Table Properties dialog - Font Effects page

Table Properties dialog

The Table Properties dialog has five tabbed pages that provide formatting options for **Font**, **Font Effects**, **Borders**, **Background**, and **Shadow**. To open the Table Properties dialog use one of the following methods:

- Right-click in a table and select **Table Properties** from the context menu.
- Go to **Format > Table > Properties** on the Menu bar.
- Click on **Table Properties** on the Table toolbar.

The formatting options on each dialog page are as follows:

- **Font** (Figure 245) – select the required **Family**, **Style**, **Size** and **Language** for text in the table. A sample of the font selected is displayed in the preview box.
- **Font Effects** (Figure 246) – select the required **Font Color**, **Text Decoration** and **Effects** for the text in the table. A sample of the font effects applied to the text is displayed in the preview box.
- **Borders** (Figure 247) – select the required **Line Arrangement**, **Line** and **Padding** for the table and cell borders. These options are similar to the tools **Border Style**, **Border Color** and **Borders** on the Table toolbar. See Chapter 4, Changing Object Attributes for more information on the lines used for table and cell borders.

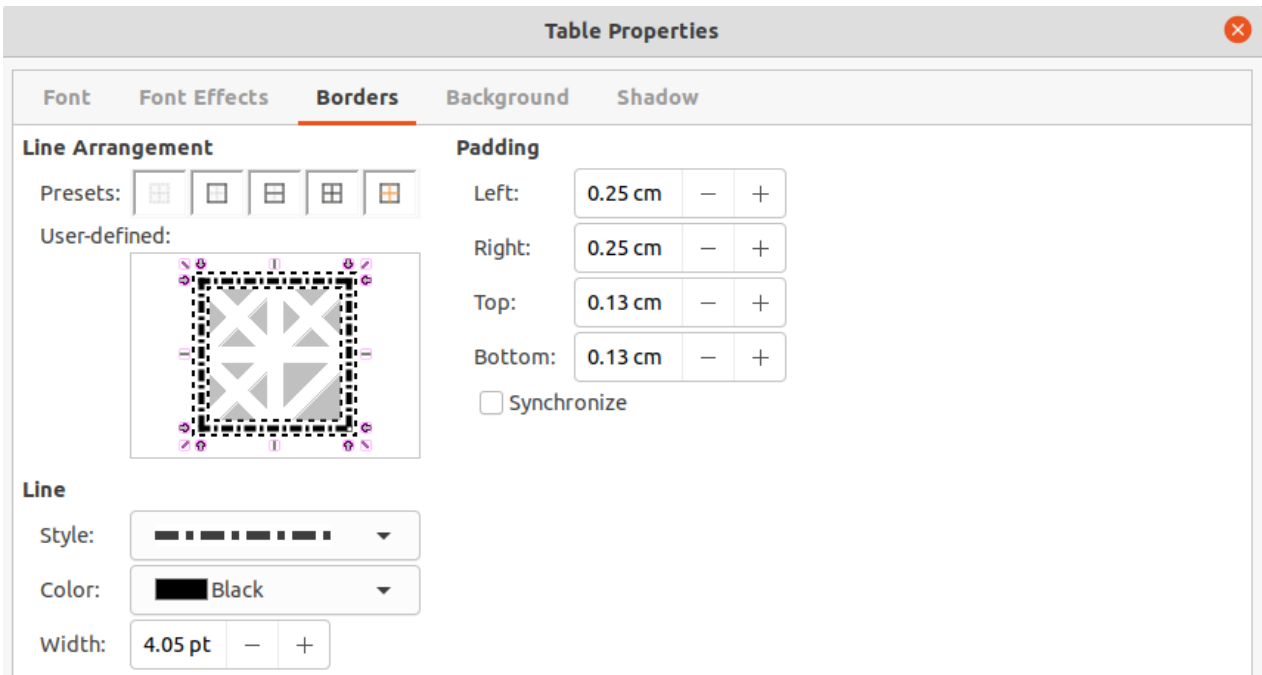

Figure 247: Table Properties dialog - Borders page

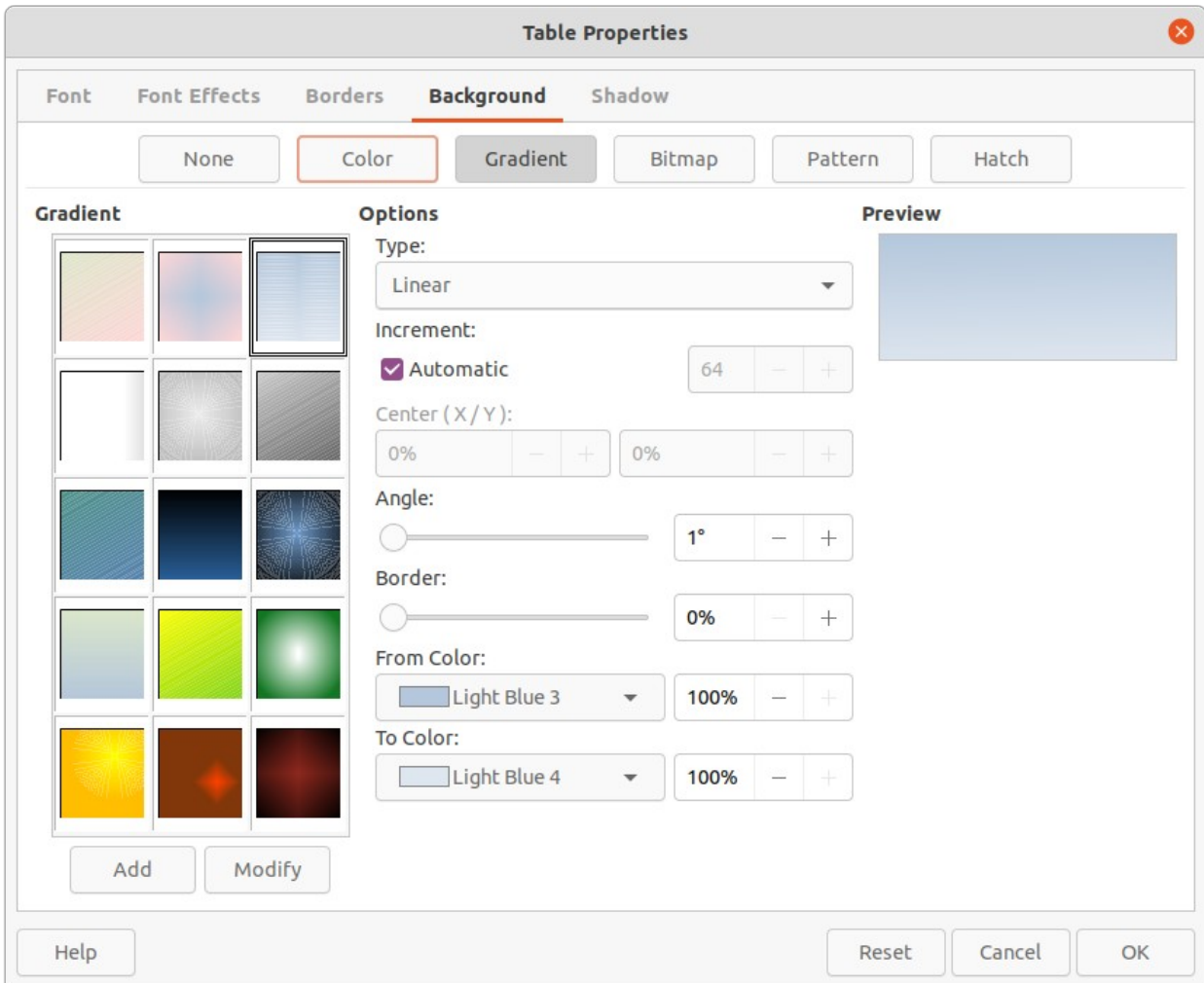

Figure 248: Table Properties dialog - Background page

- **Background** (Figure 248) – select a background as the area fill for the table and/or selected cells. This dialog page provides the same functions as **Area Style/Filling** tools on the Table toolbar. See Chapter 4, Changing Object Attributes for more information on area style and filling used for table and cell backgrounds.
- **Shadow** (Figure 249) – adds a shadow to the table. The options adjust the look and position of the shadow. See Chapter 4, Changing Object Attributes for more information on table shadows.

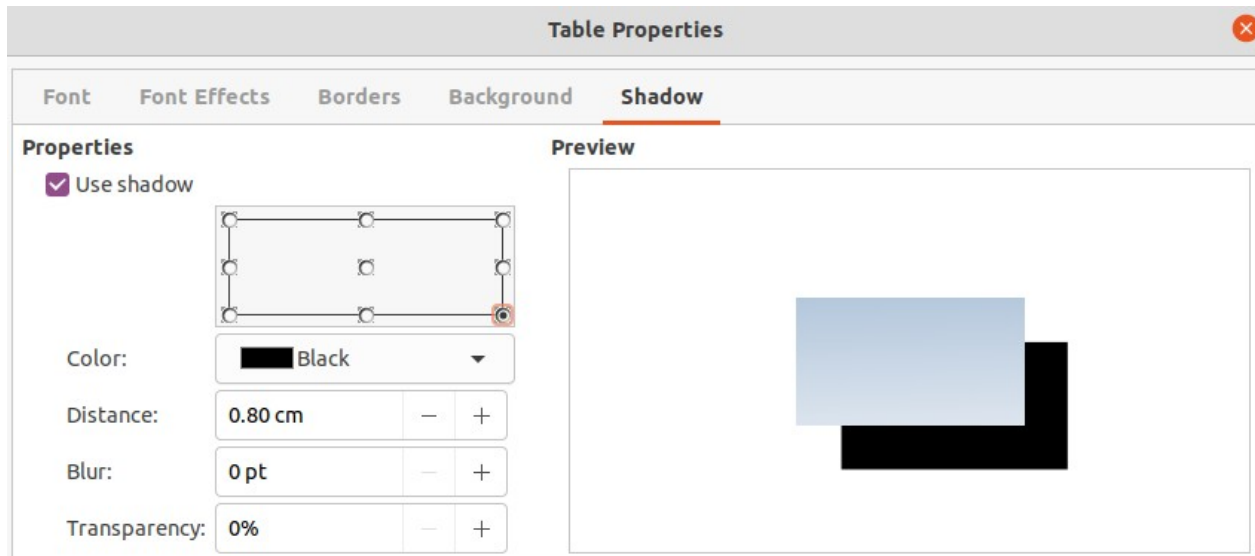

Figure 249: Table Properties dialog - Shadow page

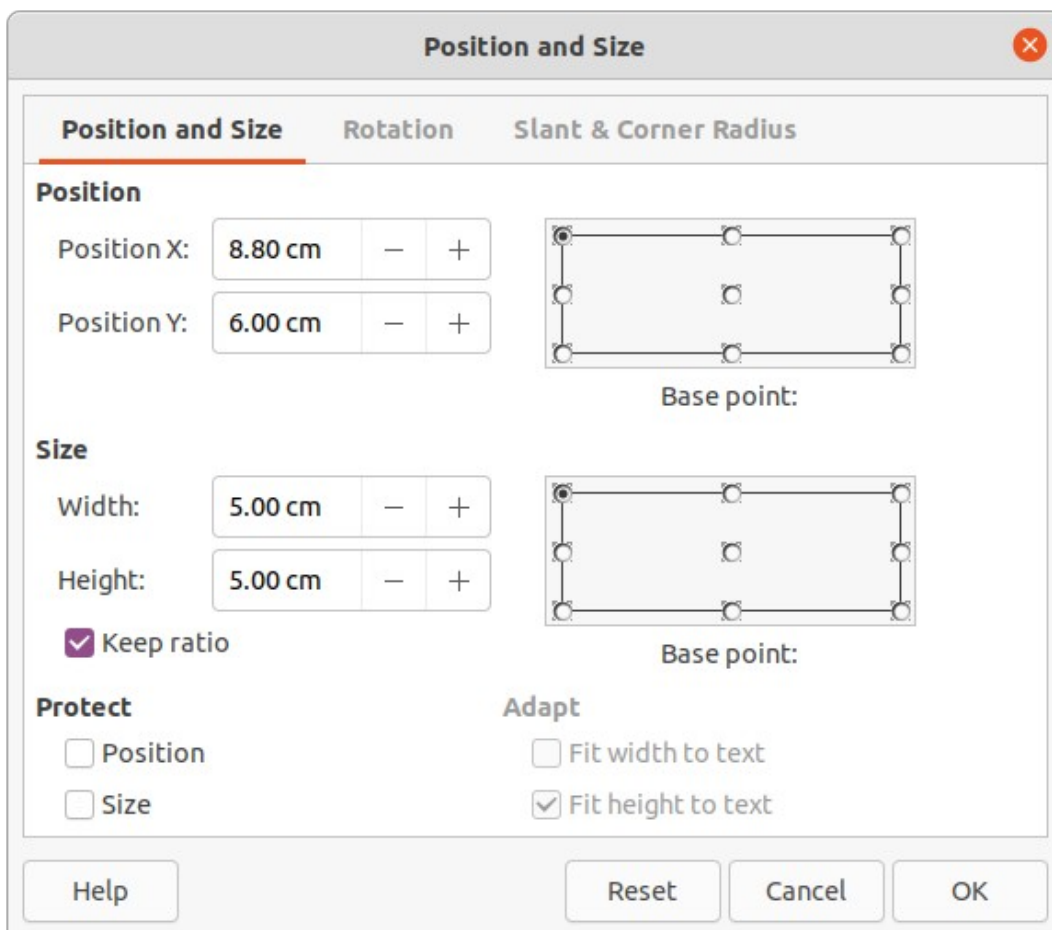

Figure 250: Position and Size dialog

Table position and size

Tables are placed into boxes when created and are treated just like any other object in a drawing. However, only the Position and Size dialog (Figure 250) can be used for tables. Some options are greyed out and are not available for tables. See Chapter 3, Working with Objects for more information on position and size.

After selecting the table, open the Position and Size dialog using one of the following methods:

- Right-click on the table and select **Position and Size** from the context menu.
- Go to **Format > Position and Size** on the Menu bar.
- Use the keyboard shortcut *F4*.

Also, table position can be changed by dragging with the cursor and text box size can be changed by dragging one of the selection handles. See “Text boxes” on page 183 for more information.

Note

When the size of a table box is changed, the table and cell contents also increases or decreases in size to match the box size.

Deleting tables

Whole table

Make sure the table is selected and the selection handles are visible on the table border, then delete the table using one of the following methods:

- Go to **Format > Table > Delete Table** on the Menu bar.
- Select **Delete Table** on the Table toolbar.
- Right-click on the table and select **Delete > Delete Table** from the context menu.

Row or column

Click in a table cell, then delete the table row or column using one of the following methods. Make sure the table selection handles are not be displayed.

- Go to **Format > Table > Delete Row** or **Delete Column** on the Menu bar
- Select **Delete Row** or **Delete Column** on the Table toolbar.
- Right-click and select **Delete > Delete Row** or **Delete Column** from the context menu.

Cell contents

Delete cell contents in a table as follows:

- 1) Select the cell or cells.
- 2) Press the *Delete* or *Backspace* key on the keyboard.

Using fields

Fields allow for the automatic insertion of text into a drawing. Fields are commonly used when creating templates and drawing masters. For more information on templates and master drawings, see Chapter 11, Advanced Drawing Techniques.

Inserting fields

A text box is created when a field is inserted into the center of a drawing and can be repositioned just like any other text box. See “Text boxes” on page 183 for more information.

- 1) Go to **Insert > Field** on the Menu bar and select the type of field.
- 2) If necessary, position and resize the field text box. See “Text boxes” on page 183 for more information.
- 3) If necessary, format the text used for the field information. See “Formatting text” on page 191 for more information.

Field types

The fields available in Draw are as follows:

- **Date (fixed)** – inserts the current date into a drawing as a fixed field. The date is not automatically updated. Available date formats depend on the language setting in **Tools > Options > Language Settings > Language**. Right-click on the date field and select the required date format from the context menu.
- **Date (variable)** – inserts the current date into a drawing as a variable field. The date is automatically updated each time the file is opened. Available date formats depend on the language setting in **Tools > Options > Language Settings > Language**. Right-click on the date field and select the required date format from the context menu.
- **Time (fixed)** – inserts the current time into a drawing as a fixed field. The time is not automatically updated. Available time formats depend on the language setting in **Tools > Options > Language Settings > Language**. Right-click on the time field and select the required time format from the context menu.
- **Time (variable)** – inserts the current time into a drawing as a variable field. The time is automatically updated each time the file is opened. Available time formats depend on the language setting in **Tools > Options > Language Settings > Language**. Right-click on the time field and select the required time format from the context menu.
- **Author** – inserts the first and last names of the author of the drawing. This information is taken from values entered in the LibreOffice user data. To modify this information go to **Tools > Options > LibreOffice > User Data**.
- **Page Number** – inserts the page number into the current drawing. Alternatively, go to **Insert > Page Number** on the Menu bar. If a page number is to be added to every page in the drawing, go to **View > Master** on the Menu bar and insert the page number field.
- **Page Title** – inserts the page title. The default name is Page # if the page has not been renamed.
- **Page Count** – inserts the total number of pages in a drawing.
- **File Name** – inserts the name of the file used for the drawing. The file name only appears after the file has been saved.

Using hyperlinks

When inserting text that can be used as a hyperlink (for example, a website address or URL), Draw formats it automatically, creating the hyperlink and applying color and underlining.

Tip

To prevent LibreOffice from automatically turning website addresses or URLs into hyperlinks, go to **Tools > AutoCorrect Options > Options** on the Menu bar and deselect **URL Recognition**.

Tip

To change the color of hyperlinks, go to **Tools > Options > LibreOffice > Application Colors**, scroll to *Unvisited links* and/or *Visited links*, select the checkboxes, then select new colors from the color palettes for the links and click **OK**. Note this color change changes the color for all hyperlinks across all components of LibreOffice.

Inserting hyperlinks

- 1) Click in the text box at the required position for the hyperlink.
- 2) Go to **Insert > Hyperlink** on the Menu bar, or use the keyboard shortcut *Ctrl+K* to open the Hyperlink dialog (Figure 251).
- 3) Select the type of hyperlink required and the required options. See “Hyperlink types” below for hyperlink types and the options available for each type.
- 4) Click **Apply** to insert the hyperlink and save your selections. If several hyperlinks are being created, click **Apply** after inserting each hyperlink.
- 5) Click **OK** to save the changes and close the Hyperlink dialog.

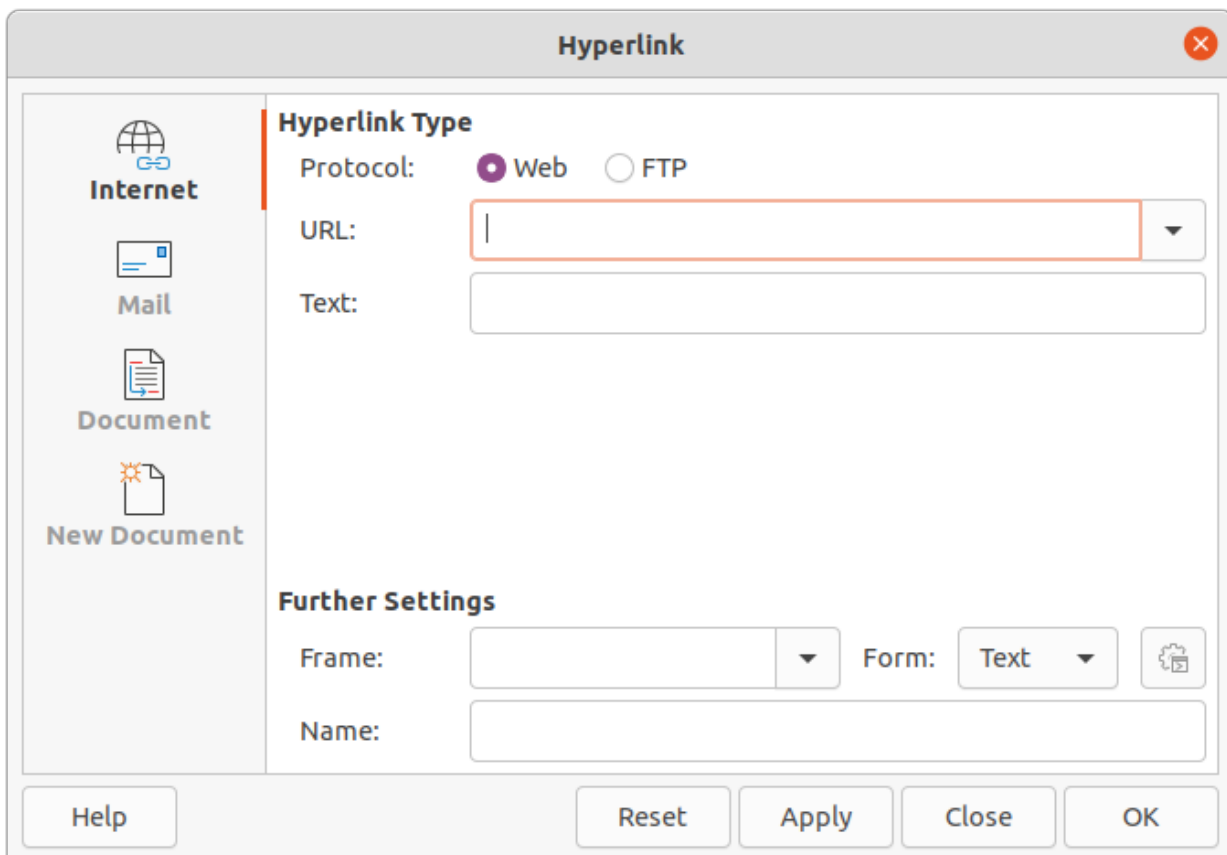

Figure 251: Hyperlink dialog

Hyperlink types

On the left side, select one of the four types of hyperlinks. The dialog changes according to the type of hyperlink selected.

- **Internet** – select whether the link is Web or FTP. Enter the required web address (URL) and any necessary text.
- **Mail** – enter the recipient details and subject for the email.
- **Document**
 - Enter the file path for the document, or click on **Open File** to open a file browser. Leave this blank if the link is to a target in the same drawing.
 - Specify a target, for example, a specific page in a drawing. Click on **Target** to open the Target in Document dialog, where a target can be selected. If the name of the target is known, enter its name into the box.
 - If necessary, enter the URL of the document. These hyperlinks are commonly referred to as a bookmark.
- **New Document** – creates a hyperlink to a new document.
 - Select *Edit now* to edit the newly created document immediately, or *Edit later* to create a new document and edit it later.
 - Select the type of document to create (text, spreadsheet, etc.).
 - Click on **Select path** to open a file browser and navigate to the folder where the new document is going to be saved.

The **Further Settings** section in the Hyperlink dialog is common to all the hyperlink types, although some options are more relevant to some types of links.

- **Frame** – determines how the hyperlink opens. This applies to documents that open in a Web browser.
- **Form** – specifies if the link is to be presented as text or as a button.
- **Text** – specifies what text is visible to the user.
- **Name** – applicable to HTML documents. It specifies the text added as a NAME attribute in the HTML code behind the hyperlink.

Editing text hyperlinks

- 1) Select the hyperlink.
- 2) Go to **Edit > Hyperlink** on the Menu bar to open the Hyperlink dialog.
- 3) Make editing changes using the available options, then click **Apply** when done. If several hyperlinks are to be edited, click **Apply** after editing each hyperlink.
- 4) Click **OK** to save the changes and close the dialog.

Image maps

An image map defines areas of the image (called hotspots) associated with a URL (a web address or a file on the computer). Hotspots are the graphic equivalent of text hyperlinks. In Draw, clicking on a hotspot opens the linked page in the appropriate program (for example, default browser for HTML pages; LibreOffice Writer for ODT files; PDF viewer for PDF files).

Hotspots can be created in various shapes, such as rectangles, ellipses, and polygons, and include several hotspots in the same image. When a hotspot is clicked on, the URL opens in a browser window or frame that has been specified. The text that appears when the cursor hovers over a hotspot can also be specified.

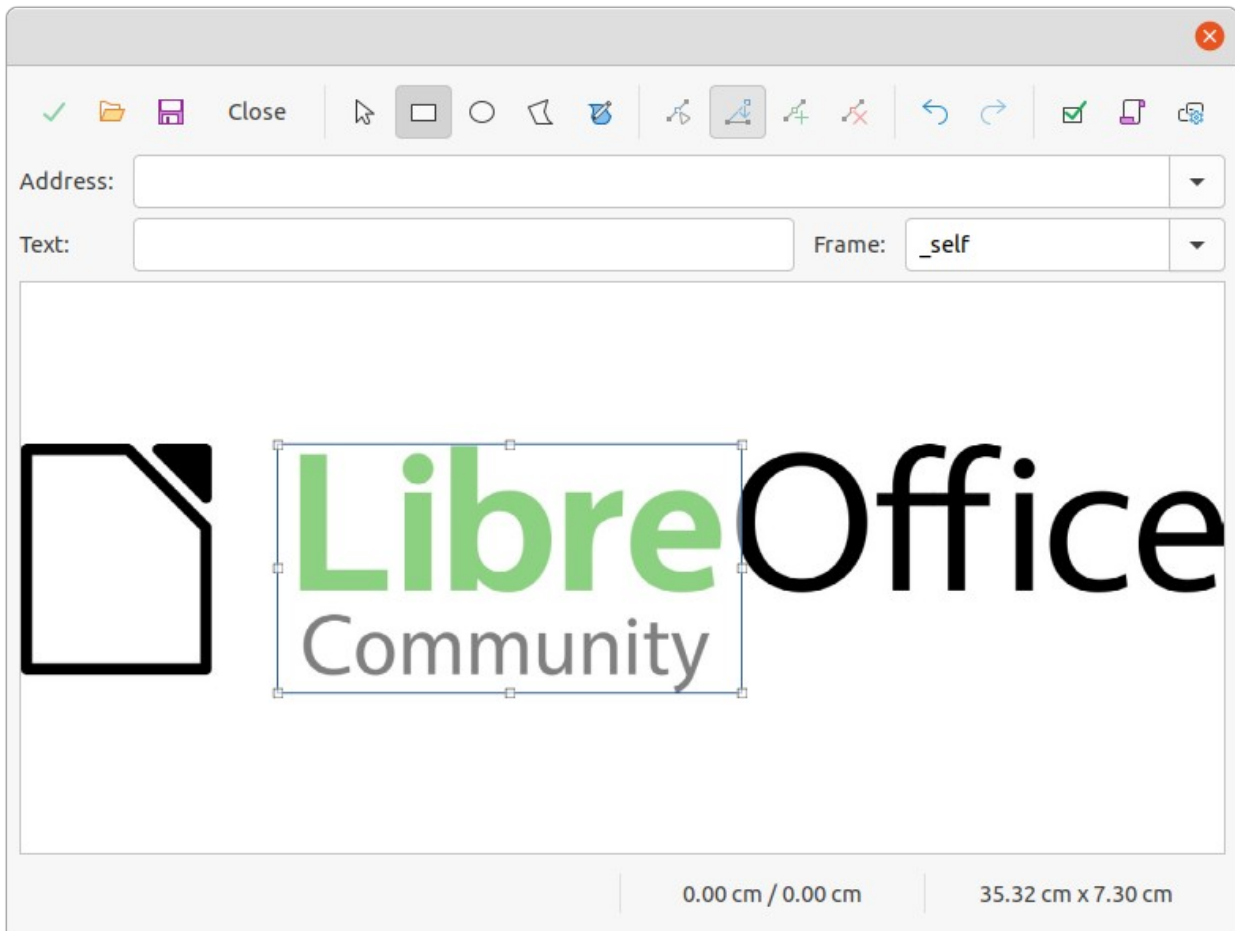

Figure 252: Image Map Editor dialog

Creating image maps

- 1) Select an image in a drawing to use as a hotspot.
- 2) Go to **Tools > ImageMap** on the Menu bar to open the Image Map Editor dialog (Figure 252). The main part of the dialog shows the selected image where hotspots will be defined.
- 3) Select the type of hotspot area required from the icons at the top of the Image Map Editor dialog – **Rectangle, Ellipse, Polygon, Freeform Polygon**.
- 4) Draw the hotspot area onto the selected image.
- 5) Enter the hyperlink address for the hotspot in the **Address** text box using the address format: `file:///<path>/document_name#anchor_name`.
- 6) Click on **Apply** to apply the settings.
- 7) Click on **Save** to save the image map to a file, then close the Image Map Editor dialog.

Image map tools

The ImageMap Editor contains the following tools:

- **Apply** – applies the changes.
- **Open** – loads into the Image Map Editor an existing image map in the MAP-CERN, MAP-NCSA or SIP StarView image map file format.
- **Save** – saves the image map in the MAP-CERN, MAP-NCSA or SIP StarView image map file format.

- **Select** – selects a hotspot in the image map for editing.
- **Rectangle, Ellipse, Polygon, Freeform Polygon** – draws a hotspot on the selected image in the shape selected.
- **Edit Points** – change the shape of the selected hotspot by editing the anchor points.
- **Move Points** – move the individual anchor points of the selected hotspot.
- **Insert Points** – adds an anchor point at the selected point on the outline of the hotspot.
- **Delete Points** – deletes a selected anchor point.
- **Undo** – cancels the previous action.
- **Redo** – reapplies the previous cancelled action.
- **Active** – toggles the status of a selected hotspot between active and inactive.
- **Macro** – assign a macro that runs when the hotspot is clicked on.
- **Properties** – define the properties of the selected hotspot.
- **Address** – enter the URL for the file that opens when the selected hotspot is clicked on. The address format to be used: `file:///<path>/document_name#anchor_name`.
- **Text** – enter the text that is displayed when the cursor rests on the hotspot . If no text is entered, the **Address** is displayed.
- **Frame** – enter the name of the target frame for the hotspot. Standard frame name can be selected from the drop-down list and used instead.
 - `_blank` – opens in a new browser window.
 - `_self` – default selection and opens in the current window.
 - `_top` – file opens in the topmost frame in the hierarchy.
 - `_parent` – file opens in the parent frame of the current frame. If there is no parent frame, the current frame is used.
- **Graphic view** – displays the image map so that the hotspots can be selected and edited.

Tip

The value `_self` for the target frame will work on the vast majority of the occasions. It is not recommended to use the other values, if available, unless absolutely necessary.

Fontwork

Using Fontwork creates graphical text as objects to make a drawing look more attractive. There are many different settings for Fontwork (line, area, position, size, and more) to match the requirements of a drawing.

Fontwork is also available with the Writer, Calc, and Impress modules of LibreOffice, but there are small differences in the way that each LibreOffice module displays Fontwork.

Creating Fontwork

- 1) Open the Fontwork Gallery dialog (Figure 253) using one of the following methods.
 - Go to **Insert > Fontwork** on the Menu bar.
 - Click on **Insert Fontwork Text** on the Standard toolbar.
 - Click on **Insert Fontwork Text** on the Fontwork toolbar, if this toolbar is visible.



Figure 253: Fontwork Gallery dialog



Figure 254: Fontwork example

- 2) Select a Fontwork style from the dialog and click **OK**. The selected Fontwork object appears in the center of the drawing and the dialog closes.
- 3) Double-click on the black text in the Fontwork object to switch on editing mode.
- 4) Type the required text which replaces the black text in the Fontwork object as shown in Figure 254.
- 5) Press the *Esc* key or click outside the selected area to apply the change.

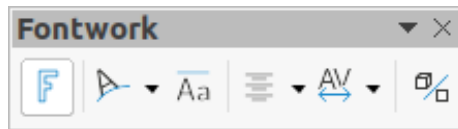

Figure 255: Fontwork toolbar



Figure 256: Fontwork Shape toolbar

Fontwork toolbar

The Fontwork toolbar (Figure 255) becomes visible and active on the workspace when a Fontwork object is selected. If the toolbar is not visible, go to **View > Toolbars > Fontwork** on the Menu bar.

The following tools are available for editing a Fontwork object.

- **Insert Fontwork Text** – opens the Fontwork Gallery dialog.
- **Fontwork Shape** – changes the shape of the selected object. Click on Fontwork Shape to open a pop-up toolbar and select a Fontwork shape for the available options. The shapes are shown in the Fontwork Shape floating sub-toolbar (Figure 256).
- **Fontwork Same Letter Heights** – changes the height of characters in the selected Fontwork object. Toggles between normal height where the characters have different heights to where all characters have the same height.
- **Fontwork Alignment** – specifies the text alignment within the frame. Options are *Left Align*, *Center*, *Right Align*, *Word Justify*, and *Stretch Justify*. The effects of the text alignment can only be seen if the text spans over two or more lines. In the stretch justify mode, all lines are filled completely.
- **Fontwork Character Spacing** – selects the spacing between characters and whether kerning pairs should be used. Options are *Very Tight*, *Tight*, *Normal*, *Loose*, *Very Loose* and *Custom*. For *Custom* spacing, input a percentage value: 100% is normal character spacing, less than 100% character spacing is tighter, and more than 100% character spacing is looser.
- **Toggle Extrusion** – converts the Fontwork object into a 3D shape using extrusion. See Chapter 7, 3D Objects for more information.

Modifying Fontwork

A Fontwork object can be treated like any other object in Draw. It can be resized, rotated, skewed, slanted, flipped, and so on. For more information on modifying a Fontwork object, see Chapter 3, Working With Objects, Chapter 4, Changing Object Attributes and Chapter 5, Combining Multiple Objects.

Fontwork is text and all text formatting that has been described in this chapter can be applied. Assign line properties only to Fontwork that is NOT going to be converted to 3D effect using Toggle Extrusion, otherwise line properties will not be visible.

Some of the Fontwork shapes can be modified. For example, to change the angles of trapezoid or parallelogram basic shapes by moving the dot that is displayed along with the selection handles.



LibreOffice
Community



Draw Guide 7.2

Chapter 10, Printing, Exporting and Emailing

Printing

Quick printing

To quickly print a document or drawing, click on **Print Directly** on the Standard toolbar (Figure 257) to send the entire document to the default printer that is defined for the computer.

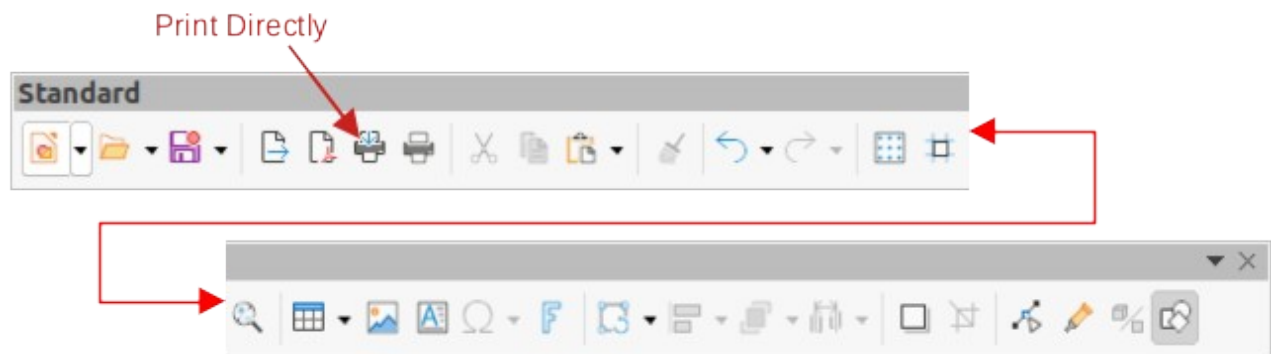

Figure 257: standard toolbar with Print Directly installed

✓ Note

The action of **Print Directly** can be changed by sending a document to the printer defined for the document instead of the default printer defined for the computer. Go to **Tools > Options > Load/Save > General** and select the option *Load printer settings with the document*.

✓ Note

If **Print Directly** is not visible on the Standard toolbar, right-click in an empty area on the Standard toolbar and select **Visible Buttons** from the context menu. Select **Print Directly** from the displayed list of tools and the tool is added to the Standard toolbar.

Controlled printing

For more control over printing, open and use the Print dialog (Figures 258 and 259) using one of the following methods:

- Go to **File > Print** on the Menu bar.
- Use the keyboard shortcut *Ctrl+P*.
- Click on **Print** on the Standard toolbar.

✓ Note

The options selected in the Print dialog only apply to the printing of the current document that is open in Draw. To specify default print settings for LibreOffice, go to **Tools > Options > LibreOffice > Print** on the main menu bar to open the Options LibreOffice Print dialog.

✓ Note

Due to different computer setups and different operating systems, the print dialog that opens on a computer monitor may differ from the dialogs shown in Figure 258 and 259. However, the printing options available for LibreOffice remain the same.

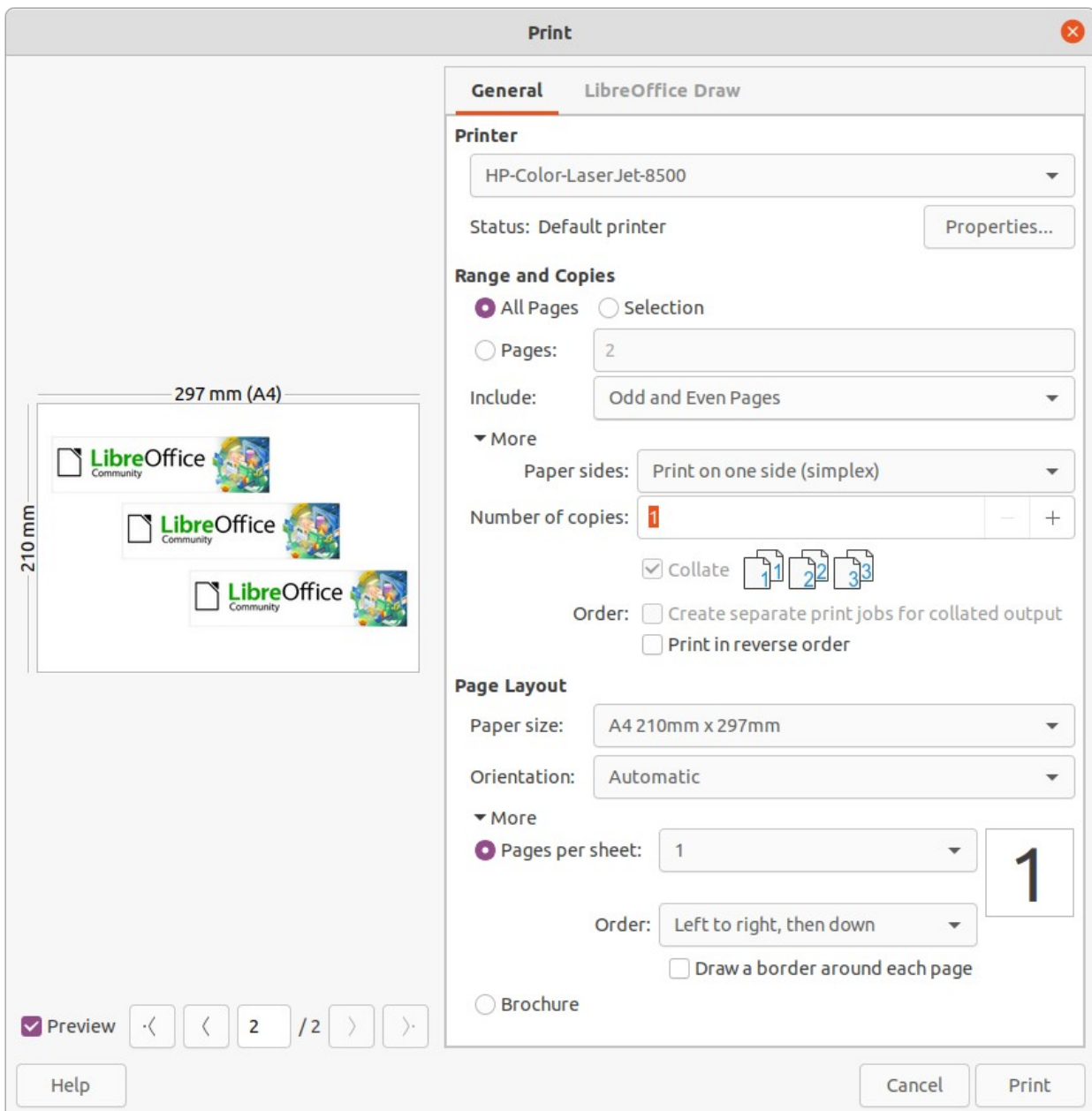

Figure 258: Print dialog - General page

✓ Note

Any print options selected with the Draw Print dialog when printing from Draw will override the default printer settings that have been set using **Tools > Options > LibreOffice > Print** and **Tools > Options > LibreOffice Draw > Print**.

General options

The following general options are an example of what may be available on the **General** page of the Print dialog (Figure 258).

- **Printer** – select the printer to use from the printers available in the drop-down list.
- **Range and Copies** – select from the following options:
 - *All Pages* – prints all the pages in the document.
 - *Selection* – prints the pages selected in LibreOffice Draw.

- *Pages* – select the page number(s) to print. For multiple pages, use the format 1, 3, 7 or 1 – 5, 7, 9 for page number selection.
- *Include* – select from the drop-down list *Odd and Even Pages*, *Odd Pages*, or *Even Pages*.
- *More > Paper sides* – select from the drop-down list *Print on one side (simplex)*, *Print on both sides (duplex long edge)*, or *Print on both sides (duplex short edge)*.
- *More > Number of copies* – enter number of printed copies required for document.
- *More > Collate* – collates multiple printed copies into separate documents.
- *More > Order* – select from *Create separate print jobs for collated output* (only available when more than one copy is being printed) or *Print reverse order*.
- **Page Layout** – select from the following options:
 - *Paper size* – select the paper size to use from drop-down list
 - *Orientation* – select from the drop-down list *Automatic*, *Portrait* or *Landscape*.
 - *More > Pages per sheet* – select from the drop-down list how many pages are printed on one sheet of paper.
 - *More > Order* – select from the drop-down list the printing order of multiple pages on one sheet of paper.
 - *More > Draw a border around each page* – when multiple pages are printed on one sheet of paper, a border is drawn around each page.
 - *More > Brochure* – prints the document so the pages can be folded into a brochure or booklet.

LibreOffice Draw options

The following options are available on the **LibreOffice Draw** page of the Print dialog (Figure 259) where settings are defined specific to the current document type:

- **Contents** – prints the *Page name* and/or *Date and time* on the drawing.
- **Colors** – prints the drawing in *Original colors*, *Grayscale*, or *Black & white*.
- **Size** – print the drawing using one of the following options:
 - *Original size* – prints the drawing using its original size.
 - *Fit to printable page* – the drawing size is changed so that it fits on the paper size used for printing.
 - *Distribute on multiple sheets of paper* – used if the drawing is too large for the paper size being used.
 - *Tile sheet of paper with repeated pages* – used to print multiple copies of a drawing on a page.

Note

The following printing instructions are examples only. Actual method of printing may differ from these examples as this depends on computer operating system, computer setup, and the printer being used.

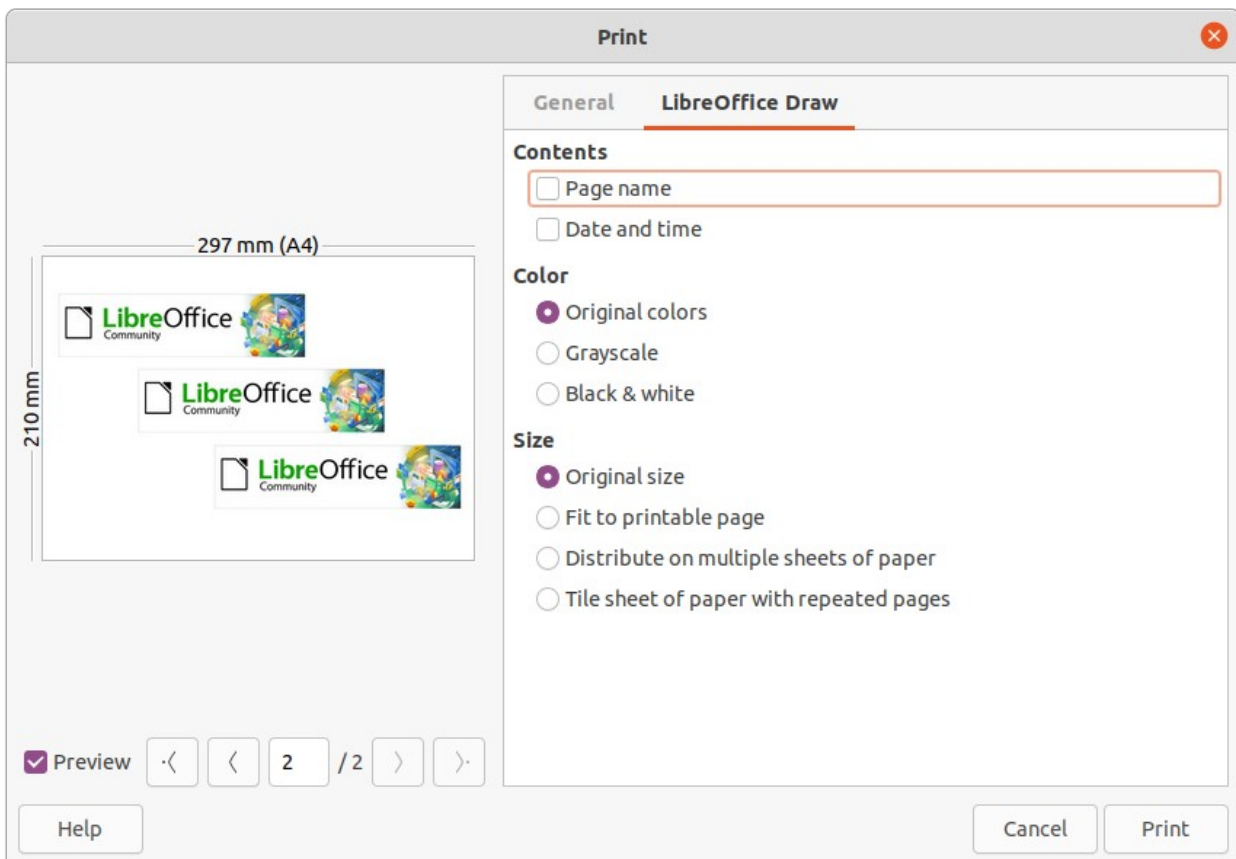

Figure 259: Print dialog - LibreOffice Draw page

Single sheet printing of multiple pages

The following steps are an example of printing multiple pages of a drawing on single sheet of paper:

- 1) Open the Print dialog, see “Controlled printing” on page 227.
- 2) Select the printer to use if more than one printer is connected to the computer.
- 3) In **Page Layout**, select the number of pages to print per sheet of paper from the *Pages per sheet* drop-down list. The preview panel on the right shows how the pages will look on a printed sheet of paper.
- 4) In **Page Layout**, select how the multiple pages are printed on the sheet of paper from the *Order* drop-down list.
- 5) If necessary, select *Draw a border around each page* to distinguish each page printed on a sheet of paper.
- 6) Click **OK** to print the document and close the Print dialog.

Selecting pages to print

Individual page

The following steps are an example of printing the individual pages in a drawing:

- 1) Open the Print dialog, see “Controlled printing” on page 227.
- 2) Select the printer to use if more than one printer is connected to the computer.
- 3) In **Ranges and Copies**, select *Pages* and enter the page number of the page to print.
- 4) Click **OK** to print the individual pages and close the Print dialog.

Range of pages

The following steps are an example of printing a range of pages in a drawing:

- 1) Open the Print dialog, see “Controlled printing” on page 227.
- 2) Select the printer to use if more than one printer is connected to the computer.
- 3) In **Ranges and Copies**, select *Pages* and enter the page numbers of the pages to print using the format, for example, 1,3,7 or 2–5,7,9 for page number selection.
- 4) Click **OK** to print the pages and close the Print dialog.

Selection printing

The following steps are an example of printing selected pages in a drawing:

- 1) Select the pages in the **Pages** panel in LibreOffice Draw.
- 2) Open the Print dialog, see “Controlled printing” on page 227.
- 3) Select the printer to use if more than one printer is connected to the computer.
- 4) In **Ranges and Copies**, select *Selection* and then select *Odd and Even Pages*, *Even Pages*, or *Odd Pages* from the drop-down list.
- 5) Click **OK** to print the pages and close the Print dialog.

Brochure printing

In Writer, Impress, and Draw, a document can be printed as a brochure (also known as booklet printing). The pages are arranged so that when the printed pages are folded in half, the pages are in the correct order to form a brochure or booklet.

Tip

Plan the document to make it look good when printed as a brochure. Choose appropriate margins, font sizes, and so on as the pages are normally printed at half size on a sheet of paper. Experiment to get the best document format to match the capabilities of the printer being used.

Simplex printer

The following steps are an example of printing a brochure or booklet on a printer only capable of simplex or single-sided printing:

- 1) Open the Print dialog, see “Controlled printing” on page 227.
- 2) Select the printer to use if more than one printer is connected to the computer.
- 3) In **Printer**, click *Properties* to open the properties dialog for the selected printer.
- 4) Make sure the printer is set to the same orientation (portrait or landscape) as specified in the page setup for the document. Usually the orientation does not matter, but it does for brochures.
- 5) Click **OK** to close the properties dialog and return to the Print dialog.
- 6) In **Page Layout**, select *More*, then select the *Brochure* option.
- 7) In **Range and Copies**, select *Even pages* or *Odd pages* from the *Selection* drop-down list.
- 8) Click **OK** to print the even or odd pages.
- 9) Take the printed pages out of the printer and put back into the printer in the correct orientation to print on the blank side. This may require some testing to find out what the correct arrangement is for the selected printer.

- 10) If *Even Pages* was selected, now select *Odd Pages* in *Range and Copies*. If *Odd Pages* was selected, now select *Even Pages* in **Range and Copies**.
- 11) Click **OK** to finish printing the document as a brochure and close the Print dialog.

Duplex printer

The following steps are an example of printing a brochure or booklet on a printer that is capable of duplex or double-sided printing:

- 1) Open the Print dialog, see “Controlled printing” on page 227.
- 2) Select the printer to use if more than one printer is connected to the computer.
- 3) In **Printer**, click *Properties* to open the properties dialog for the selected printer.
- 4) Make sure the printer is set to the same orientation (portrait or landscape) as specified in the page setup for the document. Usually the orientation does not matter, but it does for brochures.
- 5) Click **OK** to close the properties dialog and return to the Print dialog.
- 6) In **Range and Copies**, select *More*, then select *Print on both sides (duplex long edge)* from the *Paper sides* drop-down list. Actual options available for duplex printing depend on the printer model and the computer system being used.
- 7) In **Page Layout**, Select *More*, then select the *Brochure* option.
- 8) In **Range and Copies**, select the *All Pages* option.
- 9) Click **OK** to print the document as a brochure and close the Print dialog..

Black and white or grayscale printing

Printer settings

To print documents in black and white or grayscale on a color printer:

- 1) Open the Print dialog, see “Controlled printing” on page 227.
- 2) Select the printer to use if more than one printer is connected to the computer.
- 3) Click on **LibreOffice Draw** to open the printing options page for LibreOffice Draw.
- 4) In **Color**, select *Grayscale* or *Black & white*.
- 5) Click **OK** to print the document and close the Print dialog.

Note

Some color printers may only allow printing in color regardless of the settings selected. More details can be found in the information that came with the selected printer.

Tip

Grayscale is the best option for printing any colored text or graphics in a document on a monochrome printer. Colors printed in shades of gray give more detail. When printing color in black and white some of this detail maybe lost.

LibreOffice settings

To change the LibreOffice settings to print all colored text and graphics as grayscale:

- 1) Go to **Tools > Options > LibreOffice Draw > Print** on the Menu bar to open the Options LibreOffice Draw Print dialog (Figure 260).
- 2) In **Quality**, select either the option *Grayscale* or *Black & white*.

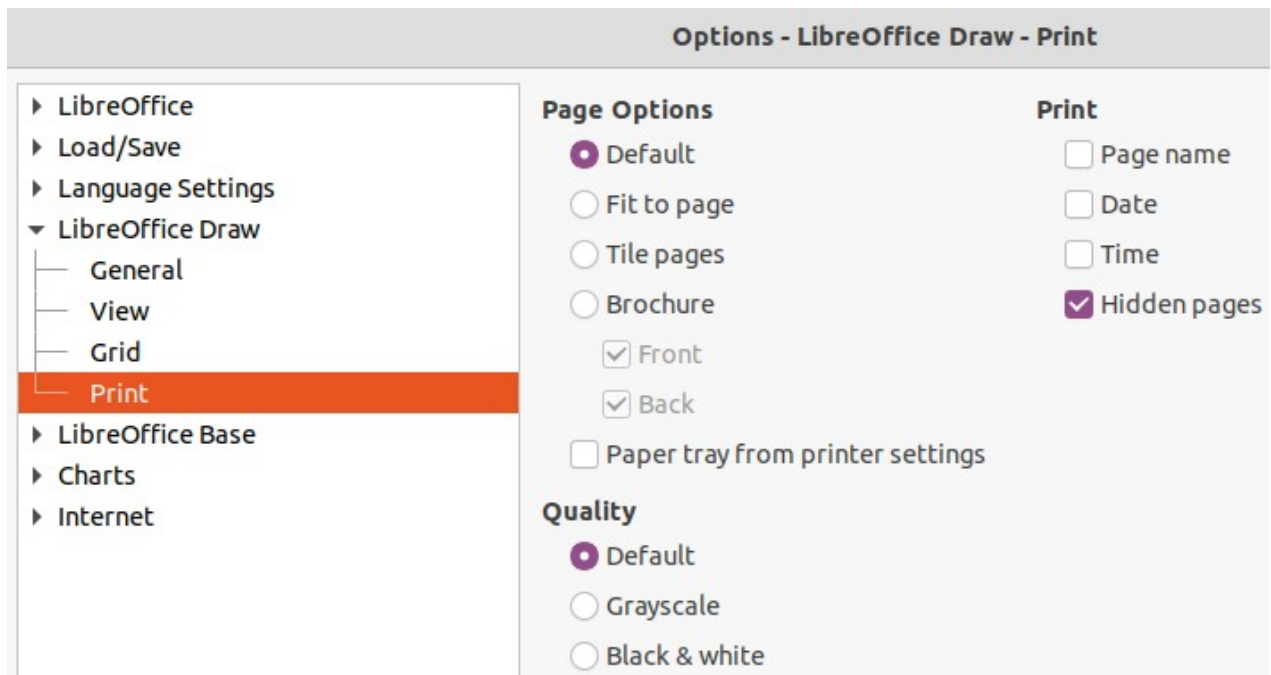

Figure 260: Options LibreOffice Draw Print dialog

- 3) Click **OK** to save the change and close the Options LibreOffice Draw Print dialog.
- 4) Print the document using one of the above procedures and the document is printed as grayscale or black and white.

Exporting

LibreOffice can export documents to PDF (Portable Document Format). This industry wide standard of file format is ideal for sending a file for someone else to view using PDF viewing software.

Directly as PDF

To export the entire document using default PDF settings is as follows:

- 1) Click on **Export Directly as PDF** on the Standard toolbar, or go to **File > Export As > Export Directly as PDF** on the Menu bar.
- 2) Enter a file name and location for the PDF file and click on **Save** to export the file as PDF.

Note

Note that page range, image compression, or other printing options are not available when creating a PDF file using this method.

Controlling PDF content and quality

For more control over the content and quality of the resulting PDF, use the options available in the PDF Options dialog (Figure 261). For more information on available options, see the *Getting Started Guide*.

- 1) Go to **File > Export As > Export as PDF** on the Menu bar to open the PDF Options dialog.
- 2) Select the required options available in the **General**, **Initial View**, **User Interface**, **Links**, **Security** and **Digital Signatures** pages.

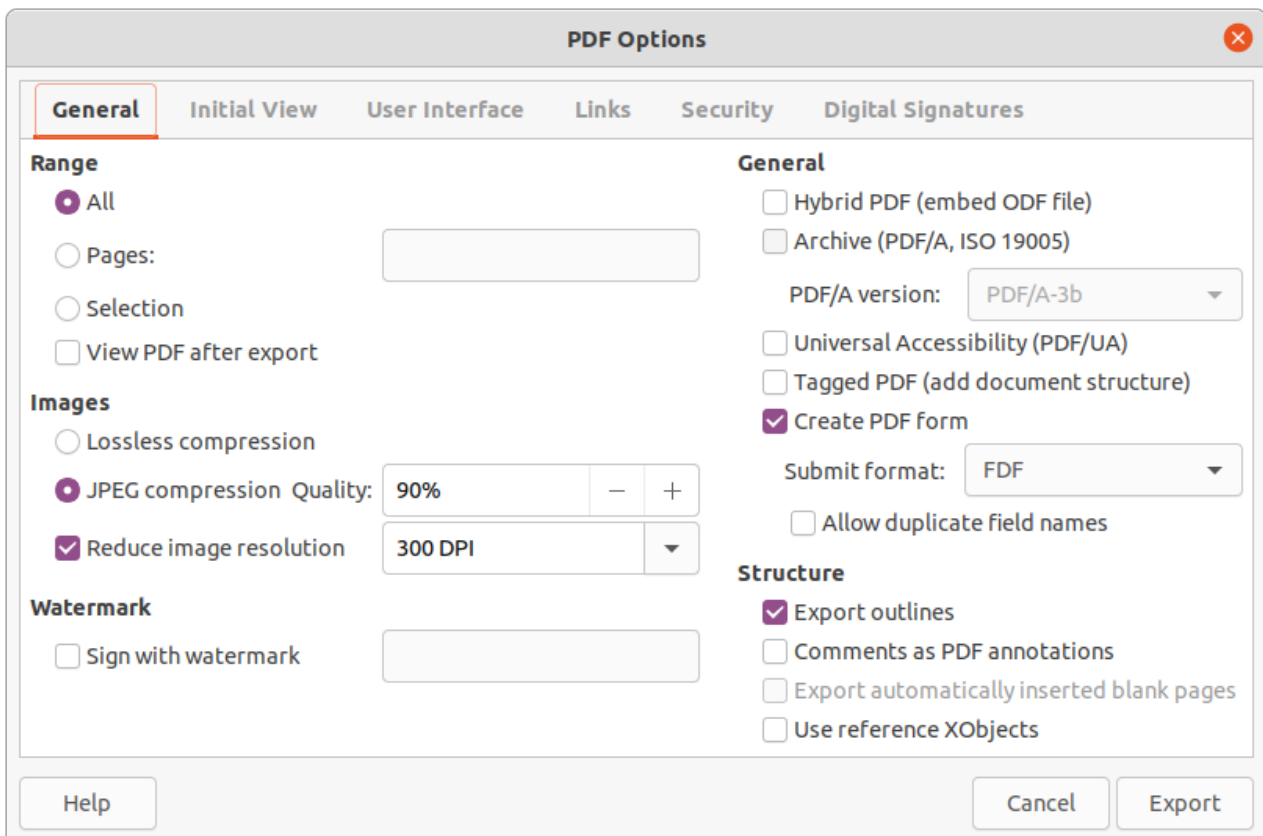

Figure 261: PDF Options dialog

- 3) Click on **Export** and a file browser window opens.
- 4) Navigate to the location and enter a file name for the PDF being created.
- 5) Click on **Save** to export the file as PDF. The file browser window and the PDF Options dialog close.

Other formats

LibreOffice can export files in various formats, which are listed in the drop-down list of the file browser window. For more information on exporting graphics, see Chapter 6, Editing Pictures.

To export a file in another format:

- 1) Go to **File > Export** on the Menu bar to open a file browser window.
- 2) Navigate to the directory where the drawing is going to be saved.
- 3) Specify a file name for the exported drawing in the **Name** text box.
- 4) Select the required file format from the drop-down list.
- 5) Click on **Save** to save the file and close the file browser window.

Note

The content of the exported file depends on the elements selected on the drawing. If no elements are selected, the entire drawing is exported.

Web pages

To export a multi-page Draw document as a series of web pages:

- 1) Go to **File > Export** on the Menu bar to open a file browser window.

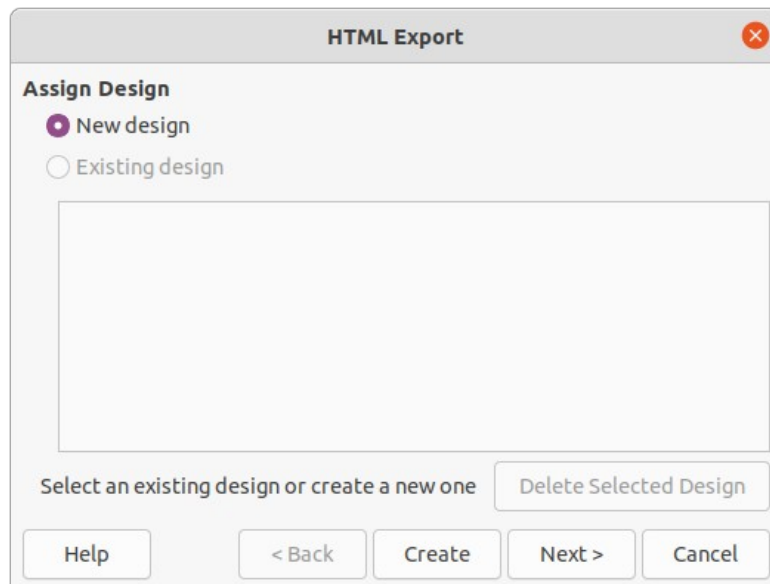

Figure 262: HTML Export dialog

- 2) Select *HTML Document (Draw) (.html;.htm)* as the file format and click on **Save** to open the HTML Export dialog (Figure 262).
- 3) Create a *New Design* or select an *Existing design* and click on **Next**.
- 4) Follow the prompts to create the web pages and save the drawing as an HTML file. For more information on how to create HTML file, see the *Getting Started Guide*.

Emailing documents

LibreOffice provides several ways to send documents quickly and easily as an email attachment in ODF format (LibreOffice default format), or as a PDF. For more information, see the *Getting Started Guide*.

Note

Documents can only be sent from the LibreOffice menu if an email profile has been set up.

Open Document format

To email the current document in ODF format:

- 1) Go to **File > Send > Email Document** on the Menu bar. LibreOffice opens the default email program with the document attached to a new email.
- 2) In the email program, enter the recipient, subject, and message, then send the email.

PDF format

To email the current document as a PDF file:

- 1) Go to **File > Send > E-mail as PDF** on the Menu bar. LibreOffice creates a PDF using the default PDF settings and then opens the email program with the PDF file attached to a new email.
- 2) In the email program, enter the recipient, subject, and message, then send the email.

Digital signatures

A digital signature is a mathematical scheme for verifying the authenticity of digital versions of drawings or documents.

To sign a drawing digitally, a personal key, also known as a certificate, is required. This personal key is stored on the computer being used as a combination of a private key, which must be kept secret, and a public key. These keys are added to a drawing when a digital signature is applied. A certificate is obtained from a certification authority, which may be a private company or a government institution.

When a digital signature is applied to a drawing, a checksum is computed from the drawing content plus the personal key being used. The checksum and public key are stored together with the drawing.

When the drawing is opened on another computer with a recent version of LibreOffice, the program computes the checksum again and compares it with the stored checksum. If both checksums are the same, the program opens the original, unchanged drawing.

In addition, the program can display the public key information from the certificate. This information can then be compared with the public key that is published on the web site of the certificate authority. Whenever the drawing is changed, this change breaks the digital signature.

For a more detailed description of how to obtain, use and manage a certificate and signature validation, see the *Getting Started Guide* and “Applying Digital Signatures” in the LibreOffice Help (https://help.libreoffice.org/7.1/en-US/text/shared/guide/digitalsign_send.html?&DbPAR=WRITER&System=UNIX).

Removing personal data

It maybe necessary to remove any personal data, versions, notes, hidden information, or recorded change from drawings before they are sent to other people or PDFs files created from the drawings.

Setting security and warning options

- 1) In **Tools > Options > LibreOffice > Security**, to open Options LibreOffice Security dialog (Figure 263).
- 2) Click on **Options** to open the Security Options and Warnings dialog (Figure 264).
- 3) Select the required options to allow LibreOffice to warn when drawings contain certain information and/or automatically remove personal information on saving.
- 4) Click **OK** to close the Security Options and Warnings dialog and save the option selection.

Removing personal data and drawing information

- 1) Go to **File > Properties** on the Menu bar to open the Properties dialog (Figure 265) for the open drawing.
- 2) In the **General** page uncheck *Apply user data*.
- 3) Click on *Reset Properties* removing any information in the created and modified fields, deleting the modification and printing dates, resetting the editing time to zero, resetting the creation date to the current date and time, and resetting the version number to 1.
- 4) Click **OK** to save the changes and close the Properties dialog.

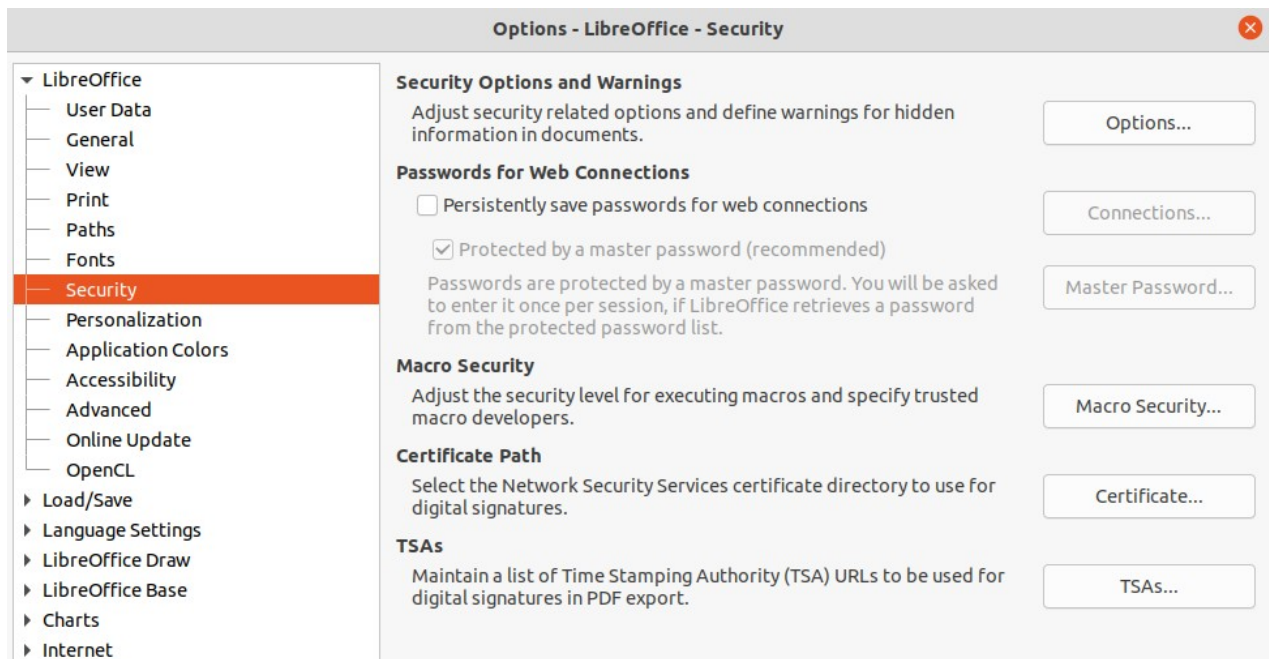

Figure 263: Options LibreOffice Security dialog

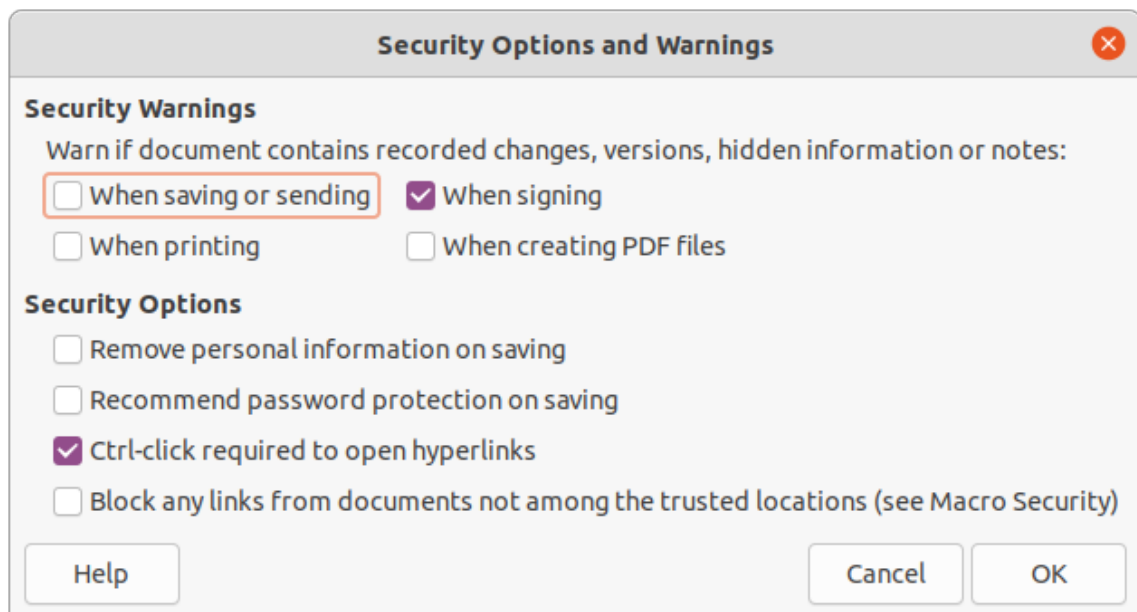

Figure 264: Security Options and Warnings dialog

Removing version information

To remove version information from a drawing, use one of the following methods:

- Go to **File > Versions** on the Menu bar to open a dialog for the drawing, then select the versions from the list for deletion and click **Delete**. The dialog automatically closes.
- Go to **File > Save As** on the Menu bar and save the drawing with a different name.

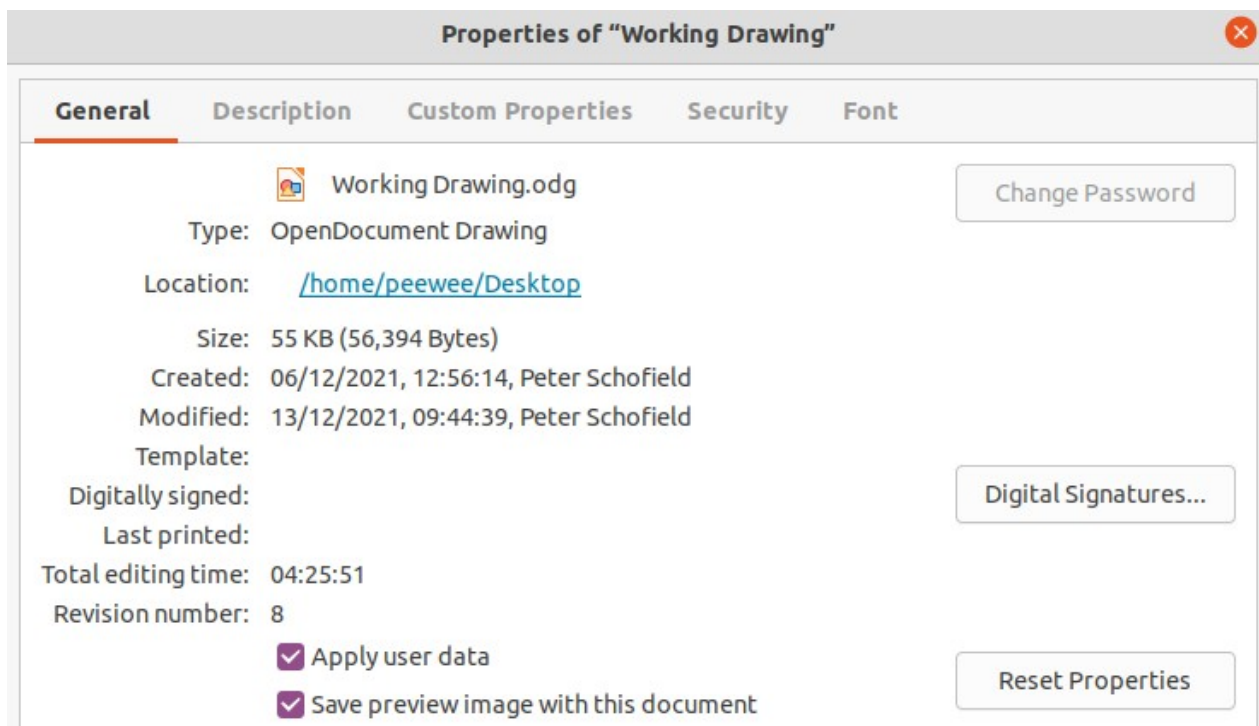

Figure 265: Properties dialog

Redaction

Documents can be redacted to remove or hide any sensitive information allowing the selective disclosure of information in a document while keeping other parts of the document secret.

When a redacted document is exported to a new document, any redacted portions are removed and replaced by redaction blocks of pixels. This prevents any attempt to restore or copy the original contents. A redacted document is often exported in PDF format for publication or sharing.

Any documents that are redacted in LibreOffice Writer, Calc, or Impress are automatically transferred as a copy to LibreOffice Draw where the redaction is carried out.

Documents, spreadsheets, or presentations

- 1) Open the document to be redacted in LibreOffice Writer, Calc or Impress, then go to **Tools > Redact** on the Menu bar and the following happens:
 - A copy of the document is prepared and transferred to LibreOffice Draw as an untitled file.
 - LibreOffice Draw opens with the untitled document displayed.
 - The Redaction toolbar (Figure 266) automatically opens. If the Redaction toolbar is not displayed, go to **View > Toolbars** on the Menu bar in LibreOffice Draw and select **Redaction**.
- 2) Go to **Tools > Redact** on the Menu bar and select either **Rectangle** or **Freeform**, or click on **Rectangle Redaction** or **Freeform Redaction** in the Redaction toolbar.



Figure 266: Redaction toolbar

- 3) Draw the required shapes to redact the sensitive areas in the document. The redaction shape is gray allowing the sensitive areas in the document to be visible before they are redacted.
- 4) If necessary, click on **Export Directly as PDF** to make an in-redaction copy of the document as a PDF file. The sensitive information in the redacted areas can then be reviewed that it is correct before redaction is finalized.
- 5) Go to **Tools > Redact** on the Menu bar and select either **Redacted Export (White)** or **Redacted Export (Black)**, or click on **Redacted Export (White)** or **Redacted Export (Black)** in the Redaction toolbar. This opens a file browser window.
- 6) Navigate to the folder where the redact document is going to be saved and enter a name for the document, then click on **Save** to create the redacted PDF file.
 - The gray redaction shapes are converted to white or black shapes and the document is exported as a PDF.
 - There is no selectable text in the PDF file and any redacted content is non-existent.

Drawings

Open a drawing in LibreOffice Draw, then use Steps 2) thru 6) in “Documents, spreadsheets, or presentations” to create a redacted PDF copy of the drawing file.



Note

When a redacted document is exported as a new PDF file, any redacted portions are removed from the new document and replaced by redaction blocks of pixels. This prevents any attempt to restore or copy the original contents.



LibreOffice
Community



Draw Guide 7.2

Chapter 11, Advanced Draw Techniques

Drawing pages

Pages pane

A drawing created in Draw can consist of multiple pages allowing a drawing to be stored as one file on a computer. The drawing pages are displayed as thumbnails in the **Pages** page which is used to add, rename, delete, and arrange pages in a drawing.

By default the **Pages** page (Figure 267) appears docked on the left of the **Workspace**. If the **Pages** page is not visible, go to **View > Page Pane** on the Menu bar.

- For Windows and macOS only – press and hold the *Ctrl* key, then double-click in the title bar of the **Pages** pane to create a floating window.
- For macOS only – press and hold the *Cmd* (⌘) key, then double-click in the title bar of the **Pages** pane to create a floating window.
- For Windows, Linux and macOS – click in the title bar and drag the **Pages** pane to create a floating window.
- To close the **Pages** pane, click on the X on the right side of the title bar, or deselect **View > Page Pane** in the Menu bar.

Selecting pages

Select a page using one of the following methods and the page appears in the **Workspace**:

- Click on a page thumbnail in the **Pages** pane.
- Select a page in the Navigator after opening.

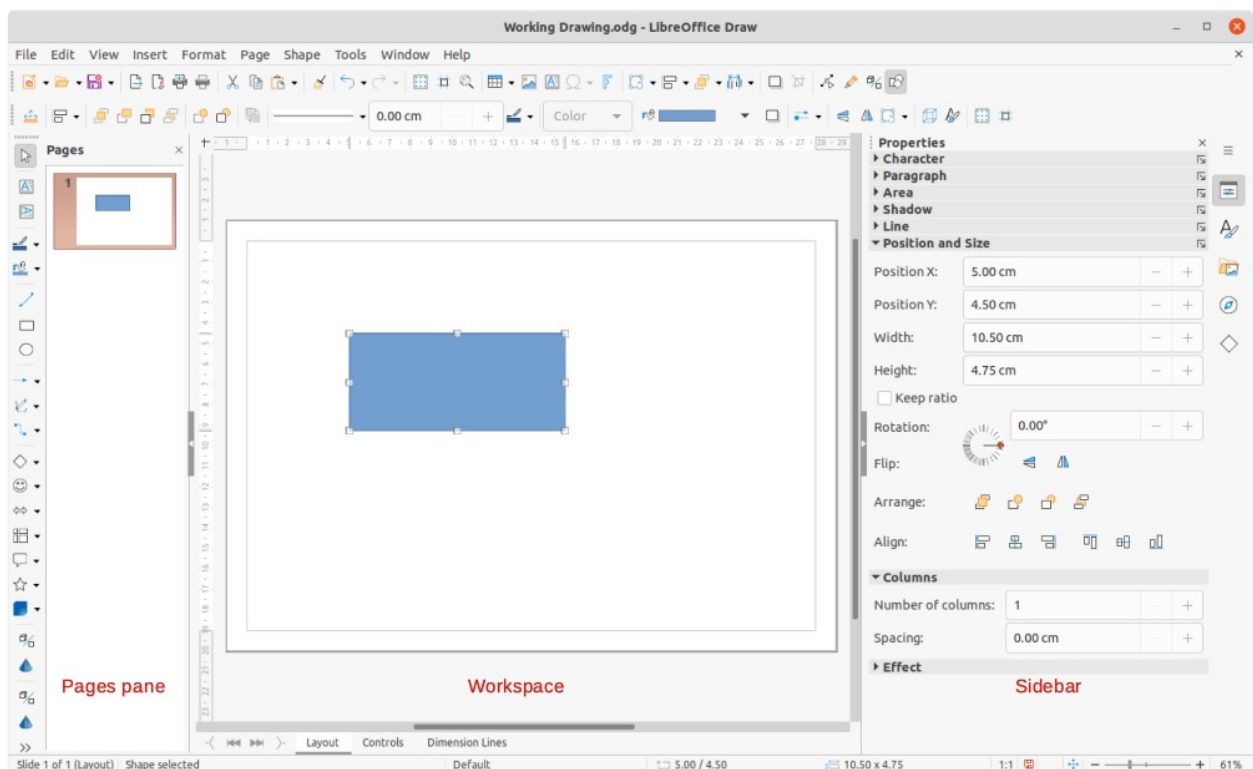

Figure 267: Draw main window

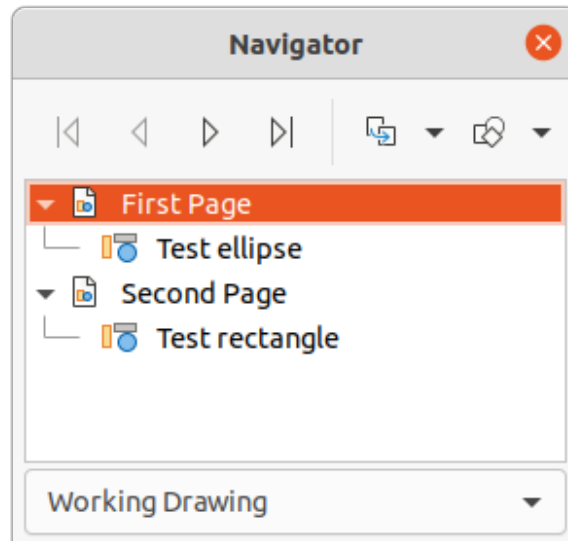

Figure 268: Navigator dialog

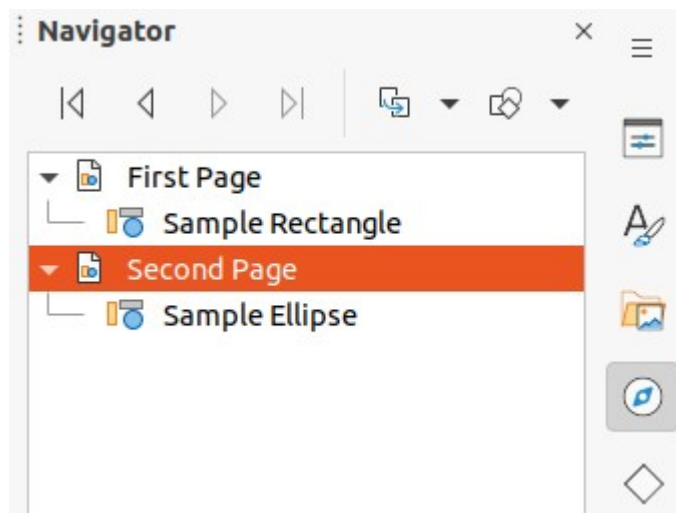

Figure 269: Navigator deck on Sidebar

If the Navigator is not open, use one of the following methods to open it:

- Press the *F5* key to open the Navigator dialog (Figure 268).
- Go to **View > Navigator** on the Menu bar to open the Navigator dialog.
- Click on **Navigator** on the right of the Sidebar to open the Navigator deck (Figure 269).

Navigating pages

To quickly select a page for editing so it appears in the Workspace, either select the page in the **Pages** pane, or go to **Page > Navigate** on the Menu bar and select one of the options from the submenu:

- **To First Page** – moves the selection to the first page in the drawing.
- **To Previous Page** – moves the selection backward to the previous page.
- **To Next Page** – moves the selection forward to the next page.
- **To Last Page** – moves the selection to the last page in the drawing.

Adding pages

Inserting new page

A new page is inserted into a drawing using one of the following methods. A new page is added after the selected page in the **Pages** pane, or at the end of the pages if no page is selected.

- Go to **Page > New Page** on the Menu bar.
- Right-click in the **Pages** pane and select **New Page** from the context menu.
- Right-click on the page displayed in the **Workspace** and select **New Page** from the context menu.
- Go to **Page > Insert Page from File** on the Menu bar and the Insert File dialog opens. Navigate to the folder where the file is located, select the file, click on **Open** and then click **OK**.

Duplicating pages

Select a page in the **Pages** pane, then use one of the following methods to insert the duplicate page after the selected page:

- Go to **Page > Duplicate Page** on the Menu bar.
- Right-click on a page in the **Pages** pane and select **Copy** from the context menu, then right-click in a blank area of the **Pages** pane and select **Paste** from the context menu.

Renaming pages

When pages are inserted into a drawing, they are automatically named as Page 1, Page 2, and so on in the **Pages** pane and the Navigator. As the page order is changed, pages are automatically renumbered. However, to easily identify each page, it is recommended to give each page a memorable name.

- 1) Select a page for renaming in the **Pages** pane.
- 2) Rename the selected page using one of the following methods:
 - Go to **Page** on the Menu bar and select **Rename Page** from the submenu.
 - Right-click on the selected page in the **Pages** pane and select **Rename Page** from the context menu.
 - Right-click on the page displayed in the **Workspace** and select **Rename Page** from the context menu.
- 3) In the Rename Page dialog that opens, type a new name for the page and click **OK** to save.

Changing page order

- Select a page thumbnail in the **Pages** pane, then click and drag the page thumbnail to change the page order.
- Select a page thumbnail in the **Pages** pane, then go to **Page > Move** on the Menu bar and select one of the following options
 - **Page to Start** – moves the selected page to the beginning of the drawing.
 - **Page Up** – moves the selected page up one place in the page order of the drawing.
 - **Page Down** – moves the selected page down one place in the page order of the drawing.
 - **Page to End** – moves the selected page to the end of the drawing.

Deleting pages

- 1) Select a page for deletion in the **Pages** pane.
- 2) Delete the selected page using one of the following methods:
 - Go to **Page > Delete Page** on the Menu bar.
 - Right-click on the selected page in the **Pages** pane and select **Delete Page** from the context menu.
 - Right-click on the page displayed in the **Workspace** and select **Delete Page** from the context menu.

✓ Note

When deleting pages in a drawing, there is no deletion confirmation of the selected page.

Master pages

A master page is a page used as the starting point for other pages in a drawing. It is similar to a page style in Writer or master slide in Impress and controls the basic formatting of all pages based upon it. A drawing with multiple pages can have more than one master page so that a different look can be assigned to separate pages in a drawing, for example title page, contents page, and drawing pages.

A master page has a defined set of characteristics. For example, background objects (such as logos, decorative lines, and other graphics), formatting of text, blocks of standard text, and fields such as page numbering, date, and filename.

Master page view

To open the master page view, go to **View > Master** on the Menu bar. This also opens the Master View toolbar (Figure 270). If this toolbar does not open, go to **View > Toolbars > Master View** on the Menu bar. To return to normal page mode, click on **Close Master View** in the Master View toolbar or go to **View > Normal** on the Menu bar.

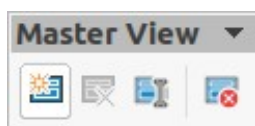

Figure 270: Master View toolbar

Creating master pages

Each drawing has a default master page. When a drawing has multiple pages, master pages can be created and added to the drawing as follows:

- 1) Go to **View > Master** on the Menu bar to open the master page view and the Master View toolbar.
- 2) Create a new master page using one of the following methods. After creation, the new master page is automatically selected.
 - Click on **New Master** in the Master View toolbar.
 - Go to **Page > New Master** on the Menu bar.
 - Right-click in the **Pages** pane and select **New Master** from the context menu.

- 3) Add the required graphic objects, logos, fields, text and so on to the selected master page, then save the drawing.
- 4) Assign the new master page to a drawing page. See “Assigning master pages” below for more information.
- 5) If necessary, rename the master page with a meaningful name, see “Renaming master pages” below.

Renaming master pages

Each new master page created has the default name of Default 1, Default 2, and so on. It is recommended to rename a new master page with a more meaningful name. The default master page that was created when the drawing was first created can also be renamed.

- 1) Go to **View > Master** on the Menu bar to open the master page view and the Master View toolbar.
- 2) Open the Rename Master Slide dialog (Figure 271) using one of the following methods:
 - Click on **Rename Master** in the Master View toolbar.
 - Right-click on a master page in the **Pages** pane and select **Rename Master** from the context menu.
- 3) Enter a meaningful name for the master page in the **Name** text box, then click **OK** to save the changes and close the Rename Master Slide dialog.

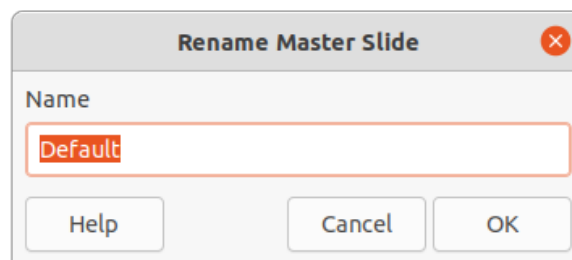

Figure 271: Rename Master Slide dialog

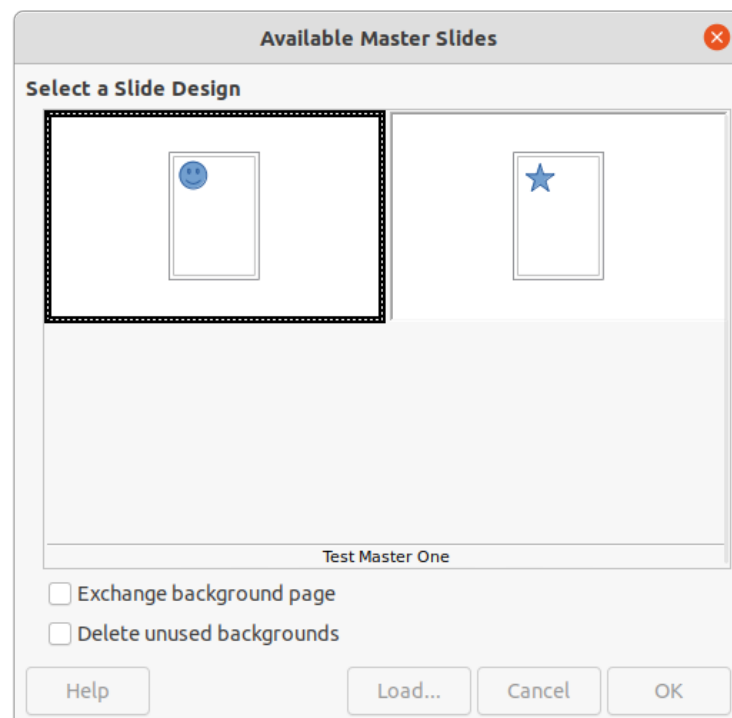

Figure 272: Available master Slides dialog

Assigning master pages

When a drawing has more than one master page, different master pages can be assigned to different pages.

- 1) Go to **View > Normal** on the Menu bar.
- 2) In the **Pages** pane, select the page to assign a master page to it.
- 3) Right-click on the page in the **Workspace** and select **Change Slide Master** from the context menu to open the Available Master Slides dialog (Figure 272).
- 4) Select a master page design for the selected page in **Select a Slide Design**.
- 5) If necessary, select **Exchange background page** to use the selected master page for all pages in the drawing.
- 6) If necessary, select **Delete unused backgrounds** to delete any master pages shown in **Select a Slide Design** that have not been assigned to a page.
- 7) Click **OK** to assign the selected master page and close the Available Master Slides dialog.

Deleting master pages

The default master page created when the drawing was first created cannot be deleted. Also, if the drawing only uses one named master page, then that named master page cannot be deleted. Deleting master pages is only available when there is more than one master page in a drawing.

- 1) Go to **View > Master** on the Menu bar to open the master page view and the Master View toolbar.
- 2) Delete a master page using one of the following methods:
 - Select and right-click on a master page in the **Pages** pane, then select **Delete Master** from the context menu.
 - Click on **Delete Master** in the Master View toolbar.
 - Go to **Page > Delete Master** on the Menu bar.

Note

The deletion of the master page is immediate and there is no confirmation.

Inserting fields

- 1) Go to **View > Master** on the Menu bar to open the master page view and the Master View toolbar.
- 2) Go to **Insert > Field** on the Menu bar and select a field type from the options available on the submenu.

The field types that are available for insertion as follows:

- **Date (fixed)** – inserts the current date into the master page as a fixed field. The date is not automatically updated.
- **Date (variable)** – inserts the current date into the master page as a variable field. The date is automatically updated each time the file is opened.
- **Time (fixed)** – inserts the current time into the master page as a fixed field. The time is not automatically updated.
- **Time (variable)** – inserts the current time into the master page as a variable field. The time is automatically updated each time the file is opened.

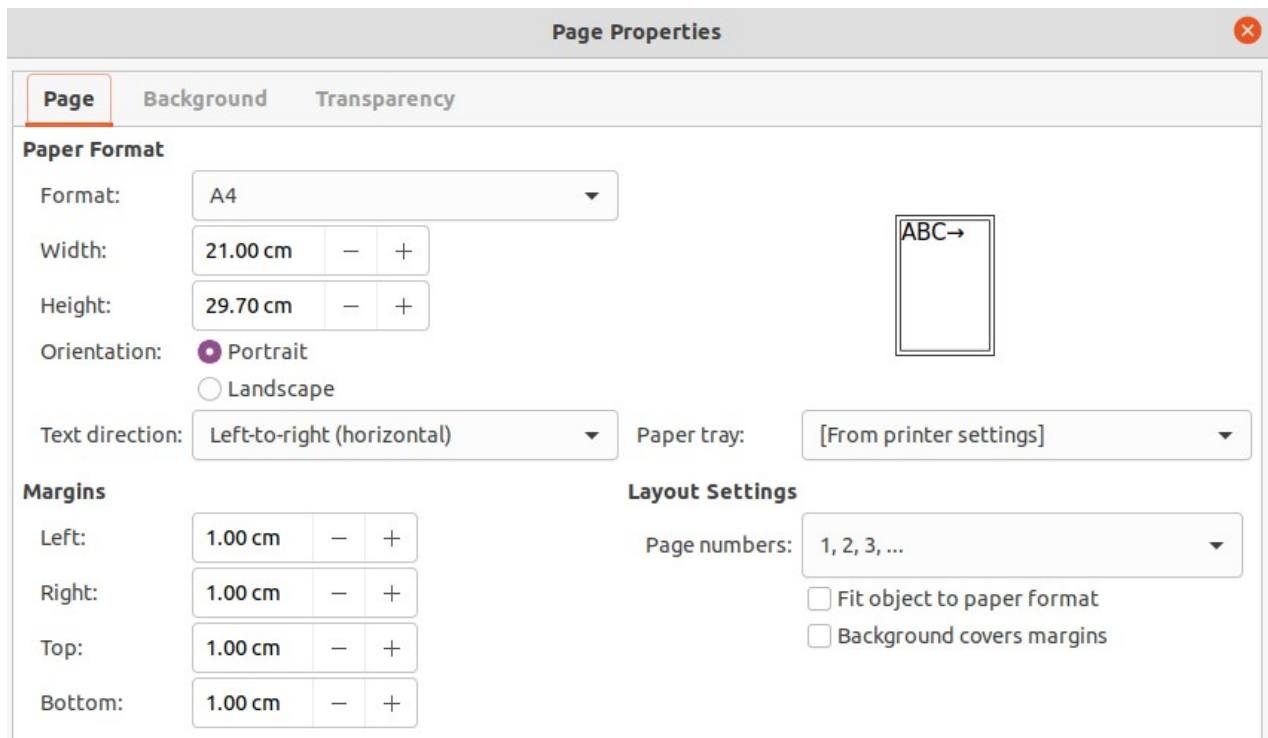

Figure 273: Page Properties dialog

- **Author** – inserts the first and last names listed in the LibreOffice user data into the active page. Go to **Tools > Options > LibreOffice > User Data** on the Menu bar to enter user data details.
- **Page Number** – inserts the page number into every page of the drawing. To change the number format, go to **Page > Page Properties** on the Menu bar to open the Page Properties dialog (Figure 273). Click on the **Page** tab and select a number format from the drop-down list in **Layout Settings**.
- **Page Title** – inserts the page title. A page title is created in Normal view by going to **Page > Rename Page** on the Menu bar and entering a title in the *Name* text box in the Rename Page dialog that opens.
- **Page Count** – inserts the total number of pages in a drawing.
- **File Name** – inserts the name of the active file. The name only appears after the file has been saved.

Editing field format

- 1) Click on a field to select it and display the selection handles.
- 2) Double click on the field contents to select the text.
- 3) Edit the field format using one of the following methods:
 - Go to **Edit > Fields...** on the Menu bar to open the Edit Field dialog (Figure 274), then select format option(s) and click **OK** to save the changes.
 - Right-click on the selected field contents and select an option from the context menu.
- 4) Click in a blank area of the master page to deselect the field.

Note

The options available in the Edit Field dialog change to match the field type that has been selected for editing.

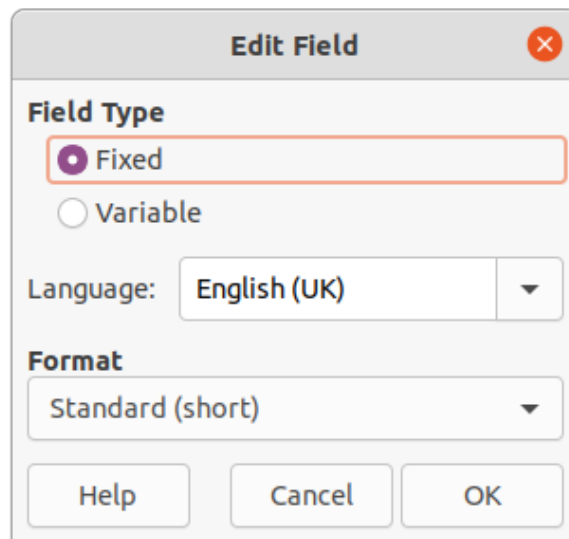

Figure 274: Edit Field dialog

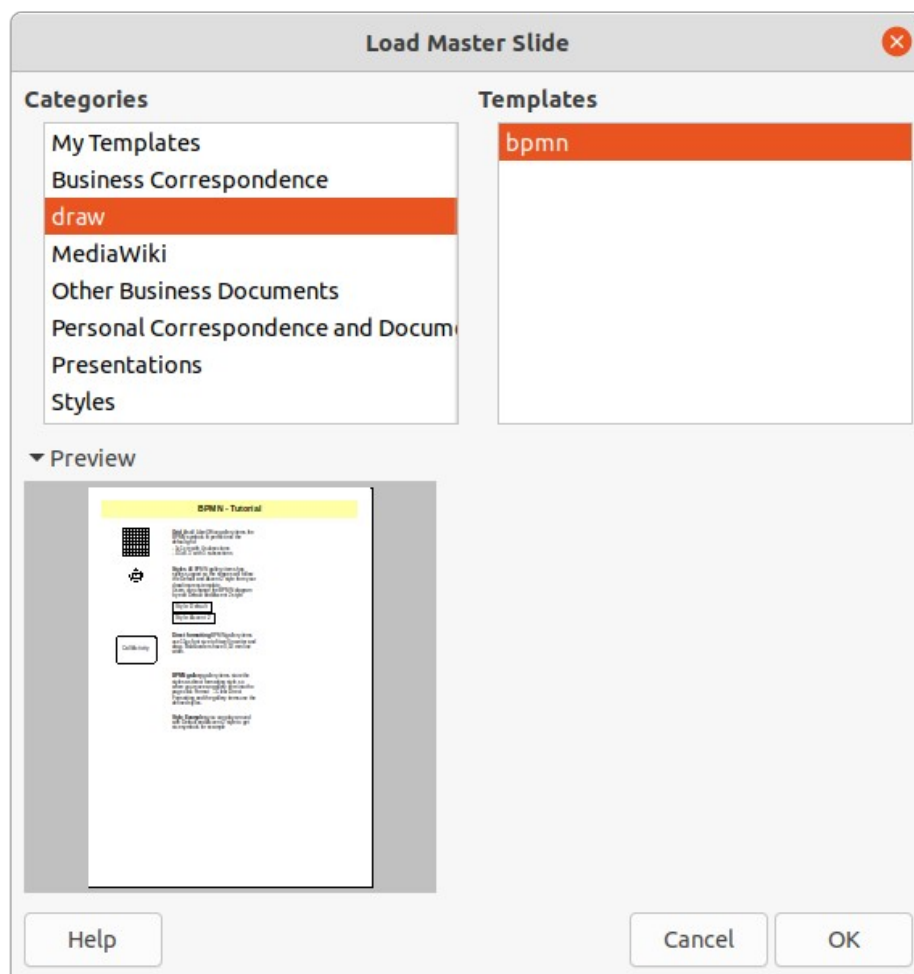

Figure 275: Load Master slide dialog

Master pages from templates

Master pages from templates available in LibreOffice can be loaded into a drawing and used. If the master pages from a template use a different page size, the master pages loaded into a drawing are adapted to the page size used in the drawing. This may cause some objects to be stretched or incorrectly positioned when adapted to fit the drawing page size.

- 1) Go to **View > Master** on the Menu bar to open the master page view and the Master View toolbar.
- 2) Right-click on a master page displayed in the drawing and select **Change Master Slide** from the context menu to open the Available Master Slides dialog.
- 3) Click on **Load...** in the Available Master Slides dialog to open the Load Master Slide dialog (Figure 275).
- 4) Chose a template category from list displayed in **Categories**.
- 5) Choose a template from the list displayed in **Templates**. Click **Preview** to display a preview of the selected template.
- 6) Click **OK** to close the Load Master Slide dialog and the Available Master Slides dialog opens displaying the template in **Select a Slide Design**.
- 7) Select the master page design required in **Select a Slide Design**.
- 8) If necessary, select **Exchange background page** to use the selected master page for all pages in the drawing.
- 9) If necessary, select **Delete unused backgrounds** to delete any master pages shown in Select a Slide Design that have not been assigned to a page.
- 10) Click **OK** to assign the selected master page to a drawing page and close the Available Master Slides dialog.

Templates

A template is a special type of drawing that is used as a basis to create a drawing. For example, a template can include a company logo, name and information on the first page of a drawing with the remaining pages in a drawing only showing the company logo and name. Templates can contain anything that regular drawings can contain, such as text, graphics, a set of styles, and so on.

All document types created using LibreOffice are based on templates. If a template is not specified when a new document is started, then the default template for that type of document is used. This default template uses a set of properties that are hard coded in LibreOffice. If necessary, the default template for drawings that is hard coded in LibreOffice can be changed, see "Default template" on page 252 for more information.

For more information on templates and obtaining templates from other sources, see the *Getting Started Guide*.

Draw does not have any predefined templates when it is installed on a computer. However, templates can be created using methods described in the following sections. Templates can also be installed that have been obtained from other sources, see "Importing templates" on page 256 for more information.

Creating drawing templates

Using Save As Template dialog

- 1) Open a drawing to use as a basis for a template, or open and edit a template to use as a basis for a new template.
- 2) Add any extra content and styles or edit the content and styles in the drawing.
- 3) Open the Save As Template dialog (Figure 276) using one of the following methods:
 - Go to **File > Templates > Save As Template** on the Menu bar.
 - Click on the triangle ▼ to the right of **Save** on the Standard toolbar and select **Save as Template** from the drop-down menu.

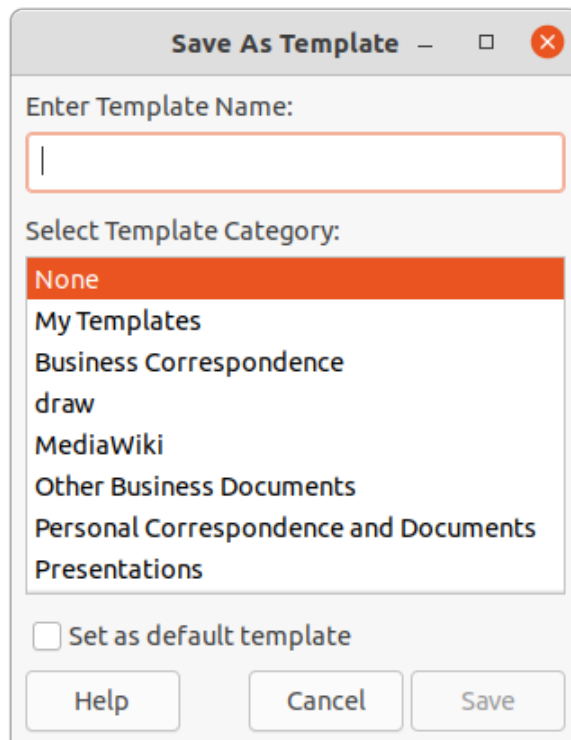

Figure 276: Save As Template dialog

- 4) Enter a name for the template in the **Template Name** text box.
- 5) Select a category for the template in the **Template Category** box.
- 6) If the template is to be used as the default template in Draw, then select the option **Set as default template**.
- 7) Click on **Save** to save the template and close the dialog.

Using Save As command

Alternatively, the command **Save As** can be used to save the drawing as a template using the following procedure:

- 1) Go to **File > Save As** on the Menu bar to open the Save as dialog.
- 2) Navigate to the LibreOffice templates folder. Actual location of the LibreOffice template folder depends on the computer system and setup.
- 3) Enter a filename using the extension .otg.
- 4) Select ODF Drawing Template (.otg) as the file type.
- 5) Click on **Save** to save the template and close the dialog.

✓ Note

When saving a drawing as a template, the template must be saved in the LibreOffice templates folder for the template to be recognized and found by the LibreOffice Template Manager.

Creating a drawing from templates

Instead of using the default settings in LibreOffice to create a new drawing, a drawing can be created from a template.

Start Center

Open LibreOffice and create a new drawing from a template displayed in the **Start Center** using one of the following methods:

- Click on **Templates** in the **Start Center** to open a display of available templates for all LibreOffice applications. Click on a template and a new document opens using the relevant LibreOffice module application for the template.
- Click on the triangle ▼ to the right of **Templates** in the **Start Center**, then select **Draw Templates** to display only the available templates for LibreOffice Draw. Click on a template and a new drawing opens using LibreOffice Draw.

Templates dialog

Instead of using the default settings in LibreOffice to create a new drawing, the Templates dialog (Figure 277) can be used as follows:

- 1) Use one of the following methods to open the Templates dialog:
 - Go to **File > New > Templates** on the Menu bar.
 - Go to **File > Templates > Manage Templates** on the Menu bar.
 - Use the keyboard short cut *Shift+Ctrl+N*.
- 2) In the **Filter** drop-down lists, select Draw as the application and the template category required for the new drawing.
- 3) Select a template from the options available in the preview box.
- 4) Click **Open** or double click on the template to create a new drawing using the selected template and close the Template dialog.
- 5) Go to **File > Save As** on the Menu bar and save the new drawing as a file using the extension `.odg`.

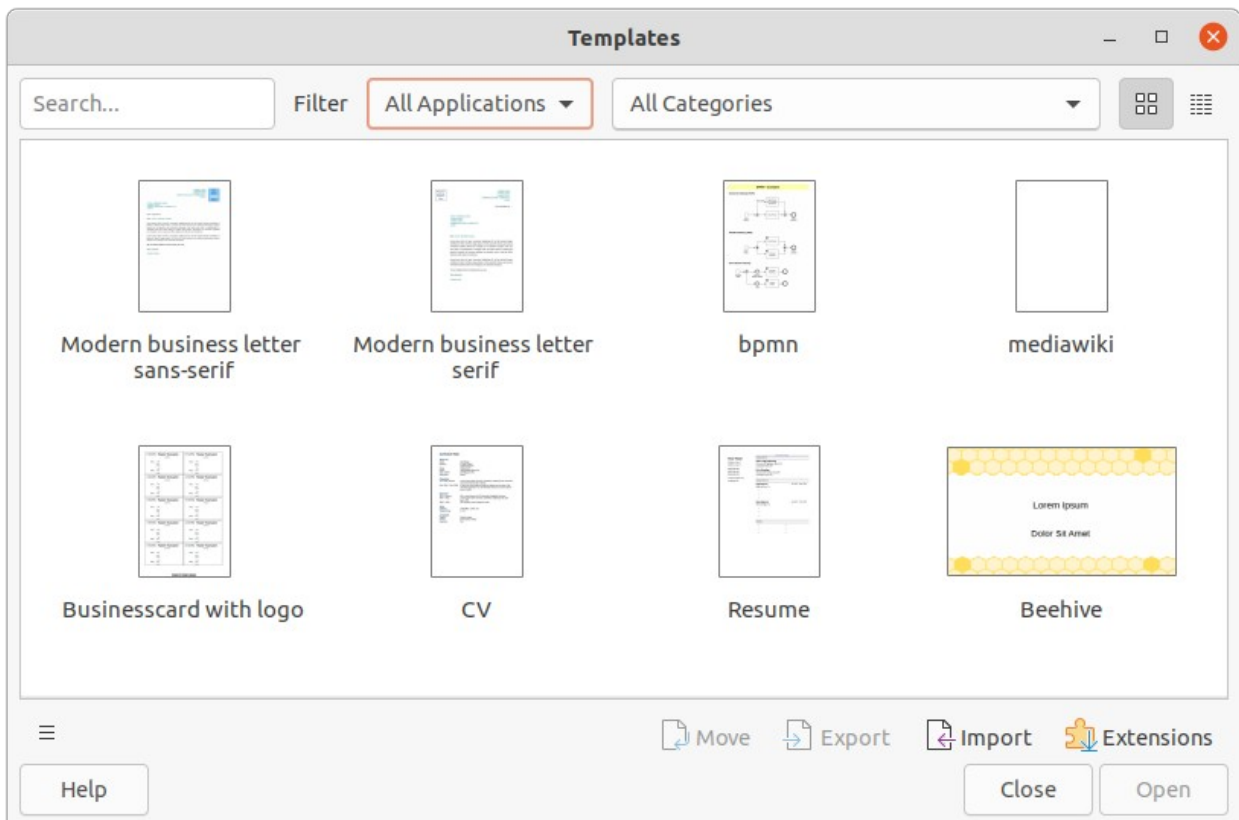

Figure 277: Templates dialog

Default template

If a new drawing is created without selecting a template, LibreOffice creates the drawing using a set of properties that are hard coded in LibreOffice. However, any drawing template can be used as the default template, but the template must be located in the templates folders used for LibreOffice applications and categories.

Setting default template

- 1) Use one of the following methods to open the Templates dialog:
 - Go to **File > New > Templates** on the Menu bar.
 - Go to **File > Templates > Manage Templates** on the Menu bar.
 - Use the keyboard short cut *Shift+Ctrl+N*.
- 2) In the **Filter** drop-down lists, select **Drawings** and then the template category.
- 3) Select a template from the templates displayed in the preview box.
- 4) Right-click on the template and select **Set as default** from the context menu. There is no confirmation that the selected template has become the default template for new drawings. The default template is indicated by check mark at the top left corner of the template icon.
- 5) Click on **Cancel** to close the Templates dialog. The next time a new drawing is created, it will use the new default template.

Note

If a new drawing is suitable to use as the default template, then the drawing must be saved as a template first before it can be used as the default template. See “Creating drawing templates” on page 249 for more information.

Resetting default template

- 1) Use one of the following methods to open the Templates dialog:
 - Go to **File > New > Templates** on the Menu bar.
 - Go to **File > Templates > Manage Templates** on the Menu bar.
 - Use the keyboard short cut *Shift+Ctrl+N*.
- 2) In the **Filter** drop-down lists, select **Drawings** and then the template category.
- 3) Right-click on the default template. The default template is indicated by check mark at the top left corner of the template icon.
- 4) Select **Reset Default** from the context menu. There is no confirmation that Draw has been reset to using LibreOffice default properties for creating a new drawing. The check mark is removed from the template icon.
- 5) Click on **Cancel** to close the Templates dialog. The next time a new drawing is created, it will use the LibreOffice default properties.

Editing templates

Note

Templates that were supplied with LibreOffice cannot be edited or deleted. Only templates that have been created using LibreOffice or imported into LibreOffice can be edited or deleted.

Template styles and template content can be edited, and then, if necessary, reapplied to drawings that were created from that template. Any content in the drawing, but not included in the template, cannot be reapplied.

Editing

- 1) Use one of the following methods to open the Templates dialog:
 - Go to **File > New > Templates** on the Menu bar.
 - Go to **File > Templates > Manage Templates** on the Menu bar.
 - Use the keyboard short cut *Shift+Ctrl+N*.
- 2) Select a template that was created using LibreOffice or imported into LibreOffice.
- 3) Right-click on the selected template and select **Edit** from the context menu. The template opens in Draw.

Note

If the **Edit** option is greyed out, then the selected template is part of the LibreOffice installation and cannot be edited.

- 4) Edit the template as any other drawing.
- 5) Go to **File > Save** on the Menu bar or use the keyboard shortcut *Ctrl+S* to save the template.
- 6) Alternatively, save the edited template as a new template. See “Creating drawing templates” on page 249 for more information.

Updating drawings from modified template

The next time a drawing is opened created from the modified template, a confirmation dialog opens asking to update the styles in the drawing to the formatting used in the modified template.

- Click **Update Styles** to update any styles in the drawing that have been changed in the template and close the confirmation dialog.
- Click **Keep Old Styles** so that styles in the drawing that have been changed in the template are not updated. The confirmation dialog closes and will not appear again the next time the document is opened.

Note

If **Keep Old Styles** is selected, the drawing is no longer connected to the template. However, the template is still listed under **File > Properties > General**. To reconnect the document to the template, the template has to be reassigned. See “Changing templates assigned to drawings” below for more information.

Changing templates assigned to drawings

If necessary, the template associated with a drawing can be changed to a different template, or reassign the original template for the drawing back to the drawing.

- To manually change or reassign a template, create a new drawing from the required template and copy the contents from the old drawing into the new drawing.
- Download the Template Changer extension from the LibreOffice website at <https://extensions.libreoffice.org/en/extensions/show/template-changer> and install it into LibreOffice. Restart LibreOffice to activate the extension. Open the drawing and use **File > Templates > Change template (current document)** on the Menu bar to change the template. For more information, see the *Getting Started Guide*.

Organizing templates

LibreOffice can only locate templates that are in LibreOffice template folders (categories). New LibreOffice template categories can be created and used to organize templates, for example creating separate categories for different projects or clients. Templates can also be imported and exported.

Tip

The location of LibreOffice template folders varies with the computer operating system. To learn where the template folders are stored on a computer, go to **Tools > Options > LibreOffice > Paths** on the Menu bar.

Creating template categories

- 1) Use one of the following methods to open the Templates dialog:
 - Go to **File > New > Templates** on the Menu bar.
 - Go to **File > Templates > Manage Templates** on the Menu bar.
 - Use the keyboard short cut *Shift+Ctrl+N*.
- 2) In the **Filter** drop-down lists, select **Drawings** as the application.
- 3) Click on **Tools** in the bottom left corner and select **New Category** from the context menu.
- 4) Enter a name in the **Enter category name** text box in the dialog that opens.
- 5) Click **OK** to save the new category in LibreOffice and close the dialog.

Renaming template categories

Template categories supplied with LibreOffice cannot be renamed. Only template categories that have been created can be renamed.

- 1) Use one of the following methods to open the Templates dialog:
 - Go to **File > New > Templates** on the Menu bar.
 - Go to **File > Templates > Manage Templates** on the Menu bar.
 - Use the keyboard short cut *Shift+Ctrl+N*.
- 2) In the **Filter** drop-down lists, select **Drawings** as the application and the template category for renaming.
- 3) Click on **Tools** in the bottom left corner and select **Rename Category** from the context menu.
- 4) Enter a name in the **Enter category name** text box in the dialog that opens.
- 5) Click **OK** to save the renamed category in LibreOffice and close the dialog.

Note

If an attempt to rename a category that was installed with LibreOffice is made, an error message opens stating that the category cannot be renamed.

Deleting template categories

Template categories supplied with LibreOffice cannot be deleted. Only template categories that have been created can be deleted.

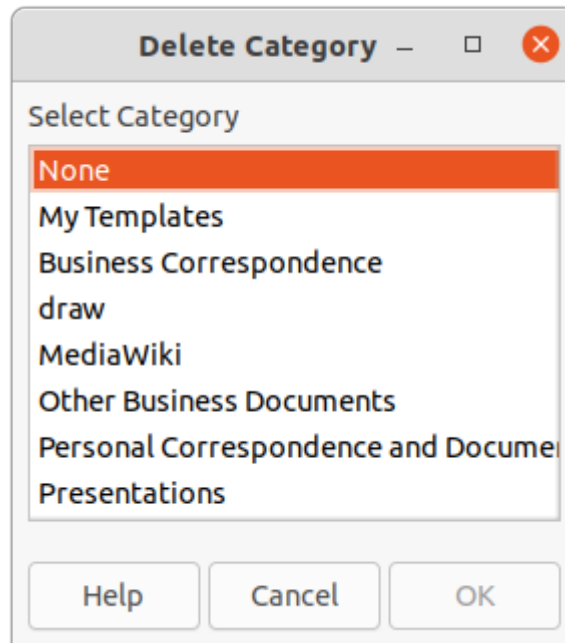

Figure 278: Delete Category dialog

- 1) Use one of the following methods to open the Templates dialog:
 - Go to **File > New > Templates** on the Menu bar.
 - Go to **File > Templates > Manage Templates** on the Menu bar.
 - Use the keyboard short cut *Shift+Ctrl+N*.
- 2) Click on **Settings** and select **Delete Category** from the context menu.
- 3) Select the category in the Delete Category dialog (Figure 278) that opens.
- 4) Click **OK** to delete the selected category and close the Delete Category dialog.
- 5) Click **Yes** to confirm the deletion of the category.

Note

If an attempt to delete a category that was installed with LibreOffice is made, an error message opens stating that the category cannot be deleted.

Moving templates

A template is moved from one template category to another template category as follows:

- 1) Use one of the following methods to open the Templates dialog:
 - Go to **File > New > Templates** on the Menu bar.
 - Go to **File > Templates > Manage Templates** on the Menu bar.
 - Use the keyboard short cut *Shift+Ctrl+N*.
- 2) In the **Filter** drop-down lists, select **Drawings** as the application and the template category where the template is located.
- 3) Select the template that is going to be moved.
- 4) Click on **Move** and the Select Category dialog (Figure 279) opens.
- 5) Select a category from **Select from Existing Category** or enter a name for a new category in **Create a New Category**.
- 6) Click **OK** to move the template to the selected category and close the Select Category dialog.

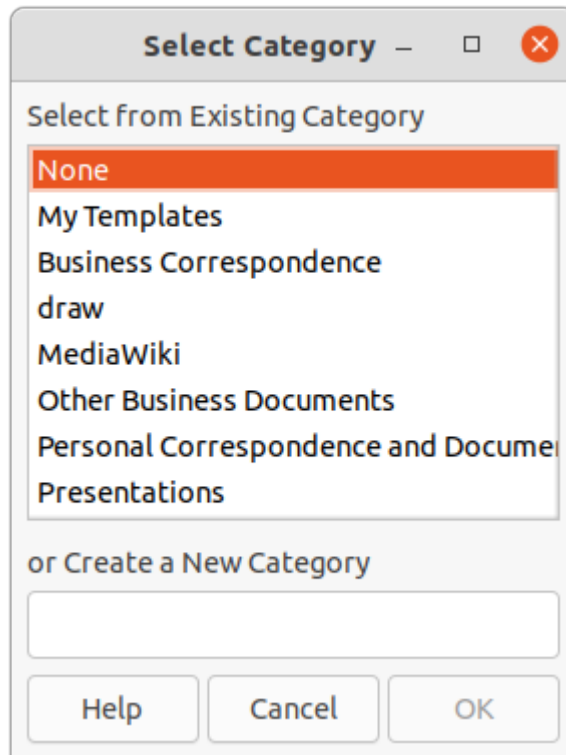

Figure 279: Select Category dialog

Importing templates

Templates can be downloaded from many sources, including the official LibreOffice template repository using the Extension Manager. Save the template anywhere on a computer, then import the template into LibreOffice as follows:

- 1) Use one of the following methods to open the Templates dialog:
 - Go to **File > New > Templates** on the Menu bar.
 - Go to **File > Templates > Manage Templates** on the Menu bar.
 - Use the keyboard short cut *Shift+Ctrl+N*.
- 2) Click on **Import** and the Select Category dialog opens.
- 3) Select a category from **Select from Existing Category** or enter a name for a new category in **Create a New Category**.
- 4) Click **OK** and a file browser window opens.
- 5) Navigate to the folder containing the template, select the template and click **Open**. The file browser closes and the template appears in the selected template category in the Templates dialog.

Note

For more information about using the Extension Manager to import templates, see the *Getting Started Guide*.

Exporting templates

Export a template from a template category to another location in a computer or network as follows:

- 1) Use one of the following methods to open the Templates dialog:
 - Go to **File > New > Templates** on the Menu bar.

- Go to **File > Templates > Manage Templates** on the Menu bar.
 - Use the keyboard short cut *Shift+Ctrl+N*.
- 2) In the **Filter** drop-down lists, select **Drawings** as the application and the template category where the template is located.
 - 3) Select a template for export and click **Export** to open a file browser window.
 - 4) Navigate to the folder to export the template into.
 - 5) Click **OK** and the exported template appears in the selected folder.
 - 6) Click **Cancel** to close the Templates dialog.

Note

Exporting a template does not remove it from the Templates dialog. The action places a copy of the template in the location specified.

Deleting templates

- 1) Use one of the following methods to open the Templates dialog:
 - Go to **File > New > Templates** on the Menu bar.
 - Go to **File > Templates > Manage Templates** on the Menu bar.
 - Use the keyboard short cut *Shift+Ctrl+N*.
- 2) In the **Filter** drop-down lists, select **Drawings** as the application and the template category where the template is located.
- 3) Right-click on the template for deletion and select **Delete** from the context menu.
- 4) Click **Yes** to confirm the deletion of the template.
- 5) Click **Cancel** to close the Templates dialog.

Tip

Press the **Delete** key on the keyboard to delete the selected template in the Templates dialog

Note

Templates that were installed with LibreOffice cannot be deleted. Only templates that have been created after the installation of LibreOffice can be deleted.

Other ways of using templates

Templates can be created and stored anywhere on a computer and then used without involving the Templates dialog. However, some results maybe different from those described above.

Drawing from a template

Create a drawing from a compatible template by double-clicking the template in a file browser window. The resulting drawing is not associated with (linked to) the template from which it was created. The template is not listed in the properties of the document and any changes to the template cannot be directly applied to the document. For many purposes, this may be what is required.

Template from a drawing

Create a template from a drawing using **File > Save As** on the Menu bar and selecting ODF Drawing Template (.otg) as the file type, then saving it anywhere on a computer, for example in a project folder.

The resulting template is visible in the Templates dialog, unless it is imported it or added to the project folder to the locations shown for templates on the *LibreOffice – Paths* page of the Tools > Options dialog. See “Organizing templates” on page 254 and “Importing templates” on page 256 for more information.

Multiple layers

Layers in LibreOffice Draw allow assembly of elements in a drawing that are related. Think of layers as individual workspaces that can be hidden from view, prevented from printing, or locked so that changes cannot be made.

Layers do not determine the stacking order of objects on a drawing, except for the **Controls** layer which is always in front of all other layers. The stacking order of objects on a drawing is determined by the sequence in objects are added. This stacking order can be rearranged by going to **Shape > Arrange** on the Menu bar.

Layers in a drawing are indicated by tabs located at the bottom of the **Workspace** and above the **Status bar**. Click on a tab to select a layer. Figure 280 shows the **Layout** layer has been selected.

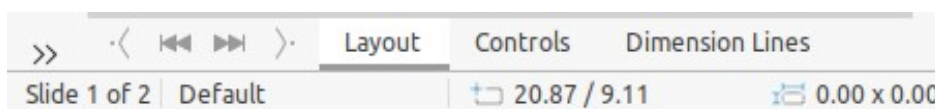

Figure 280: Layer tabs in Workspace

✓ Note

When a new layer is added, the layer is added to all pages in a drawing. However, when an object is added to a layer, the object is only added to the selected drawing page.

✓ Note

If an object is to appear on all pages of a drawing (for example, a company logo), add the object to the master page by going to **View > Master** on the Menu bar. See “Master pages” on page 244 for more information.

Default layers

Normal view

In Normal view, LibreOffice Draw provides three default layers that are visible to the user. These default layers cannot be deleted or renamed.

- **Layout** – is the default workspace where objects are normally placed.
- **Controls** – used for form controls that have been assigned an action. Objects on this layer are always in front of objects on other layers. Normally, form controls are not printed and the **Printable** option in the Modify Layer dialog has to be set deselected.
- **Dimension Lines** – is where the dimension lines are drawn. By switching the layer between show or hide, dimension lines are switched on and off.

Master view

In Master view, LibreOffice provides a single layer, **Background objects**, that is visible to the user. This layer is used to place objects that appear on every page in a drawing, for example company logo, date, page number, drawing title, and so on.

Inserting layers

Inserting a layer into a drawing is as follows:

- 1) Use one of the following methods to open the Insert Layer dialog (Figure 281):
 - Right-click the layer tab area at the bottom of the Workspace area and select **Insert Layer** from the context menu.
 - Go to **Insert > Layer** on the Menu bar.
- 2) Enter meaningful names for the layer in the **Name** and **Title** text boxes.
- 3) If necessary, enter a description for the new layer in the **Description** text box.
- 4) Select **Visible** for the layer to be visible in a drawing. When **Visible** is not selected, the layer is hidden and its name in the layer tab changes color to blue.
- 5) Select **Printable** for the layer to print when the drawing is printed. The name of a layer is underlined in the layer tab bar when **Printable** is NOT selected. For example, not printing a layer is useful if the layer is a draft layer for guides or annotations used in creating the drawing, but do not want this draft layer to appear in the final printed output.
- 6) Select **Locked** to prevent any objects on a layer from deletion, editing, or moving. No additional objects can be added to a locked layer. For example, locking a layer is useful when a base plan is to be protected while adding a new layer with other details. The name of a locked layer is changes to italic text in the layer tab bar.
- 7) Click **OK** to close the Insert Layer dialog and the new layer automatically becomes active.

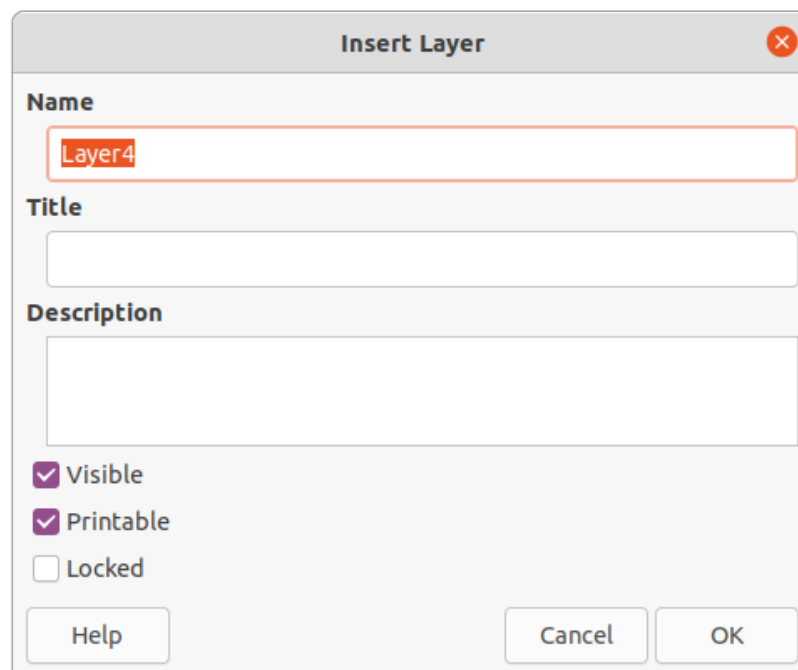

Figure 281: Insert Layer dialog

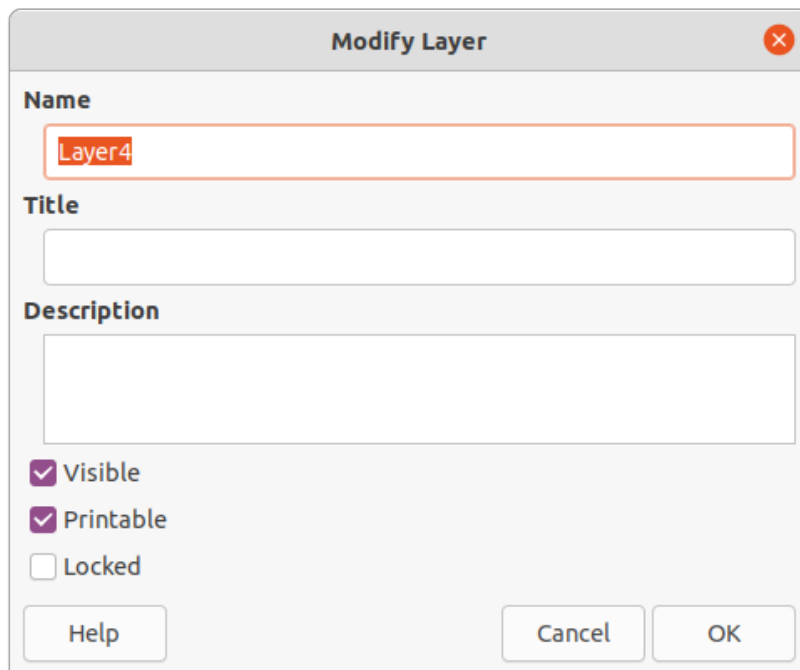

Figure 282: Modify Layer dialog

Modifying layers

Modify any or all of the attributes of an inserted layer as follows:

- 1) Use one of the following methods to open the Modify Layer dialog (Figure 282).
 - Right-click the name tab for the layer at the bottom of the Workspace and select **Modify Layer** from the context menu.
 - Click on the layer tab to select it, then go to **Format > Layer** on the Menu bar.
 - Double click on the layer tab.
- 2) Make the necessary changes to the attributes for the layer, then click **OK** to save the changes and close the Modify Layer dialog.

Working with layers

Selecting a layer

To select a layer, click on the name tab for the layer at the bottom of the **Workspace**. When a layer is selected it is activated, and any objects added to the drawing are only added to that layer. Form controls are automatically added to the **Controls** layer and dimension lines are automatically added to the **Dimension Lines** layer.

If there are several layers in a drawing, a layer tab may not be visible on the layer tab bar. Use the navigation icons on the left of the layer tab bar to navigate to the layer for selection.

Hiding layers

- 1) Select the layer that is going to be hidden and open the Modify Layer dialog. See “Modifying layers” above for more information.
- 2) Deselect **Visible** and click **OK**. The text on the layer name tab changes color to blue. Any objects placed on a hidden layer are no longer visible on the other layers in the drawing.
- 3) Alternatively, hold down the *Shift* key and click on the layer name tab to hide the layer.

Showing hidden layers

- 1) Select the hidden layer and open the Modify Layer dialog. See “Modifying layers” above for more information.
- 2) Select **Visible** and click **OK**. The text on the layer name tab changes color to the default text color. Any objects placed on a hidden layer are now visible on the other layers in a drawing.
- 3) Alternatively, hold down the *Shift* key and click on the name tab of a hidden layer to make the layer visible.

Locking layers

- 1) Select the layer that is going to be locked and open the Modify Layer dialog. See “Modifying layers” above for more information.
- 2) Select **Locked** and click **OK**. The text on the layer name tab is underlined. Locking a layer prevents any modification of the layer.
- 3) Alternatively, hold down the *Ctrl* key and click on the name tab to lock the layer.

Unlocking layers

- 1) Select the locked layer and open the Modify Layer dialog. See “Modifying layers” above for more information.
- 2) Deselect **Locked** and click **OK**. The text on the layer name tab is no longer underlined.
- 3) Alternatively, hold down the *Ctrl* key and click on the name tab of the locked layer to unlock it.

Renaming layers

- 1) Select the layer that is going to be renamed and open the Modify Layer dialog.
- 2) Enter a new name in the **Name** text box. See “Modifying layers” above for more information.
- 3) Alternatively, right-click on the name tab of the layer and select **Rename Layer** from the context menu. The text becomes editable allowing the name to be changed. Click outside the tab area to save the change.
- 4) Alternatively, hold down the *Alt* key and click on the name tab. The text becomes editable allowing the name to be changed. Click outside the tab area to save the change.

Note

Only layers that have been added to a drawing can be renamed or deleted. The default layers **Layout**, **Controls**, **Dimension Lines** and **Background objects** cannot be renamed or deleted.

Deleting layers

- 1) Right-click on the name tab of the layer that is going to be deleted and select **Delete Layer** from the context menu.
- 2) Confirm the deletion of the layer. The layer and all of the objects on the layer are deleted.

Moving objects between layers

If objects are selected on a layer, the **Status bar** indicates how many objects are selected. Move these selected objects from one layer to another layer using one of the following methods:

- Click and drag the selected objects to the name tab of the destination layer and release the mouse button. The position of the moved objects does not change and the layer where the objects have been placed is displayed in the **Status bar**.

- Go to **Edit > Cut** on the Menu bar or right-click on the selected objects and select **Cut** from the context menu. Select the destination layer, then go to **Edit > Paste** on the Menu bar or right-click on the **Workspace** and select **Paste** from the context menu. The position of the moved objects does not change and the layer where the objects have been placed is displayed in the **Status bar**.

Dimensioning

Draw allows objects to be dimensioned and display these dimensions to make a drawing look more like an engineering drawing. When dimensions are created, they are automatically placed on the **Dimension Lines** layer.

Configuring dimensioning

Two ways are available to access the options to configure dimensioning. Both methods use a dialog where the length, measurement, and guide properties of a dimension line can be changed.

Drawing object styles

- 1) Open the Graphics Styles dialog (Figure 283) using one of the following methods:
 - Go to **Format > Styles > Edit Styles** on the Menu bar.
 - Click on **Show the Styles Sidebar** on the Line and Filling toolbar to open the Styles deck on the Sidebar, then right-click on a style and select **Modify** from the context menu.

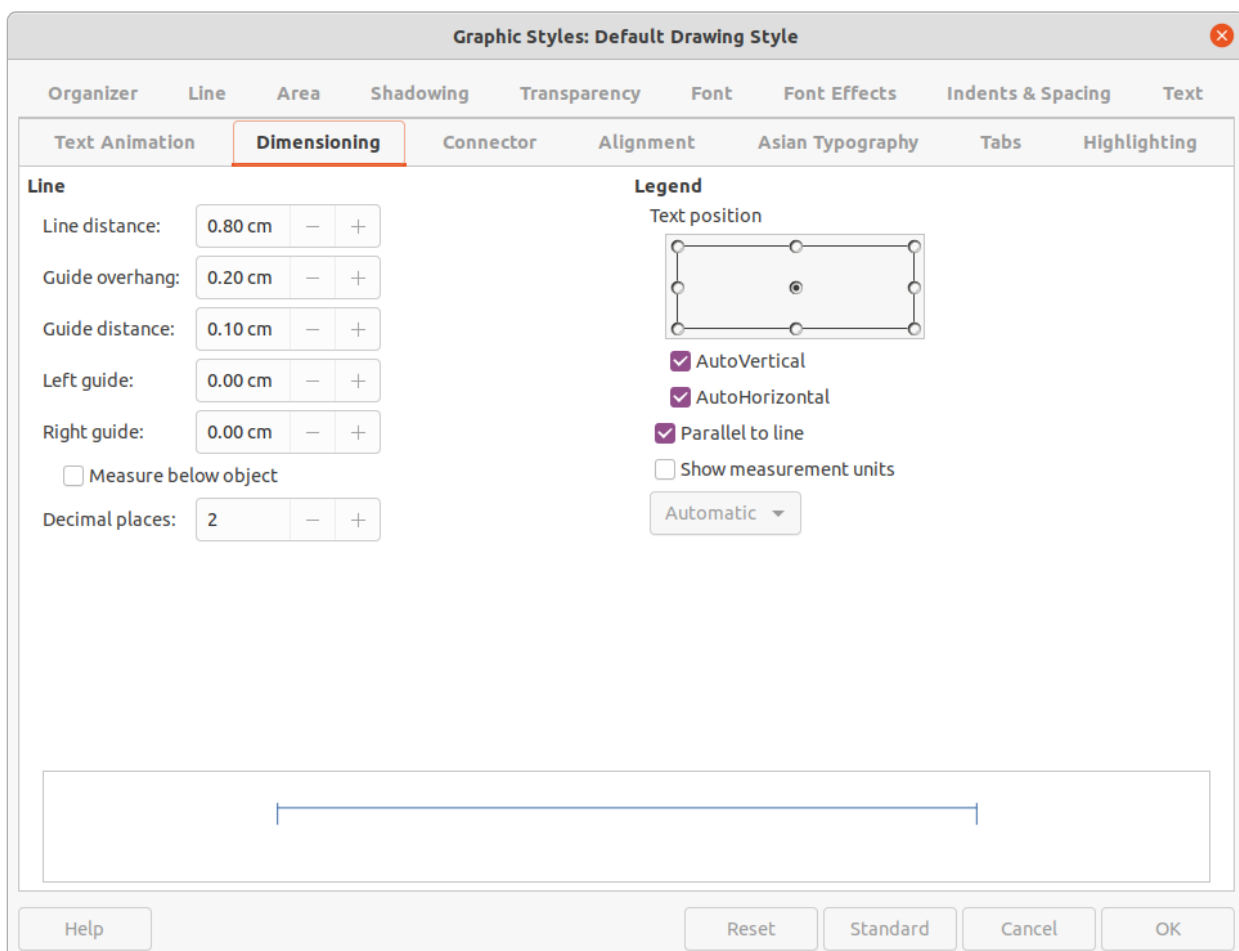

Figure 283: Graphic Styles dialog - Dimensioning page

- Use the keyboard shortcut *F11* to open the Styles deck on the Sidebar, then right-click on a style and select **Modify** from the context menu.
 - Click on **Styles** on the Sidebar to open the Styles deck, then right-click on a style and select **Modify** from the context menu.
- 2) Click on **Dimensioning** to open the **Dimensioning** page in the dialog.
 - 3) Make the changes required to dimensioning using the various options in the **Line** and **Legend** sections on the **Dimensioning** page.
 - 4) Click **OK** to save the changes and close the Graphic Styles dialog.
 - 5) To reset the dimensioning options to the default properties of the template, open the Graphics Style dialog as given in Steps 1 and 2 above, then click on **Standard**.

Dimension line dialog

- 1) Draw a dimension line. See “Dimensioning objects” on page 265 for more information.
- 2) Right-click on the dimension line and select **Dimensions** from the context menu to open the Dimension line dialog (Figure 284).
- 3) Make the required changes for dimensioning using the various options in the Dimension line dialog.
- 4) Click **OK** to save the changes and close the Dimension line dialog.

Dimensioning options

The dimensioning options in the Dimensions page in the Graphics Style dialog and the Dimension Line dialog are as follows. The preview in the dialogs changes as the following options are changed showing how the dimension line will appear in a drawing. An example dimension line is shown in Figure 285.

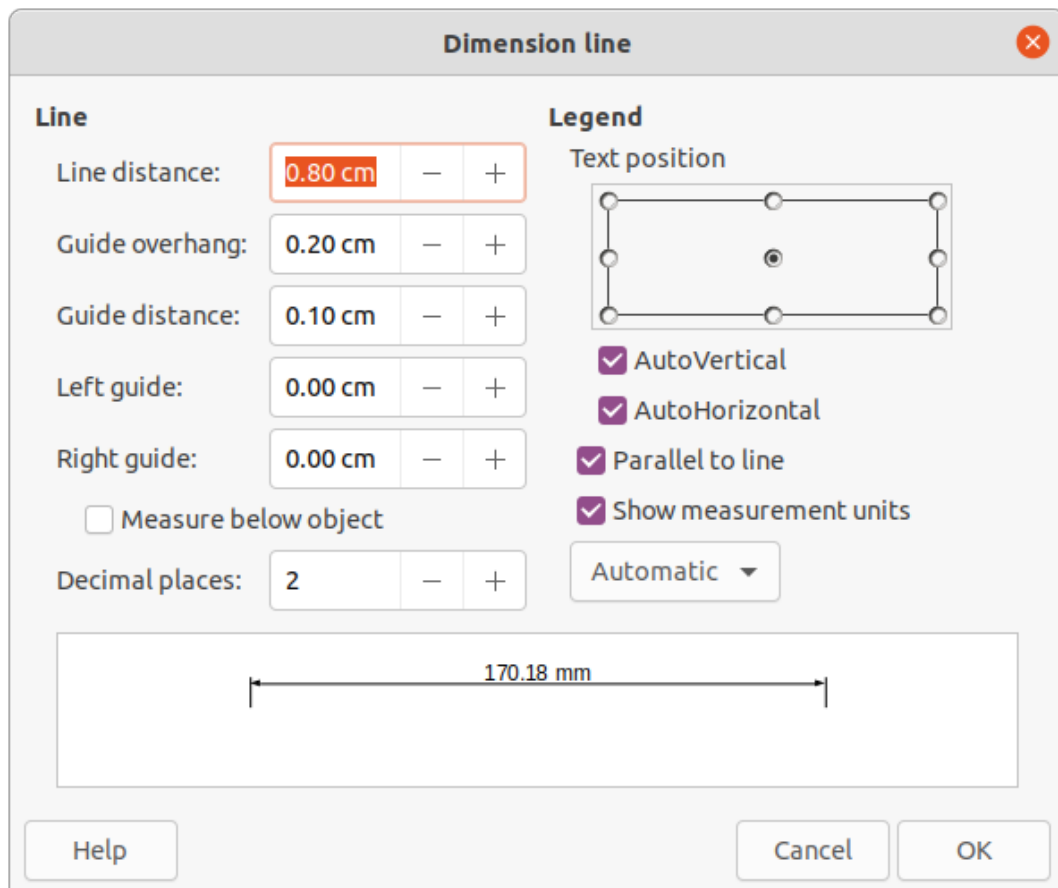

Figure 284: Dimension Line dialog

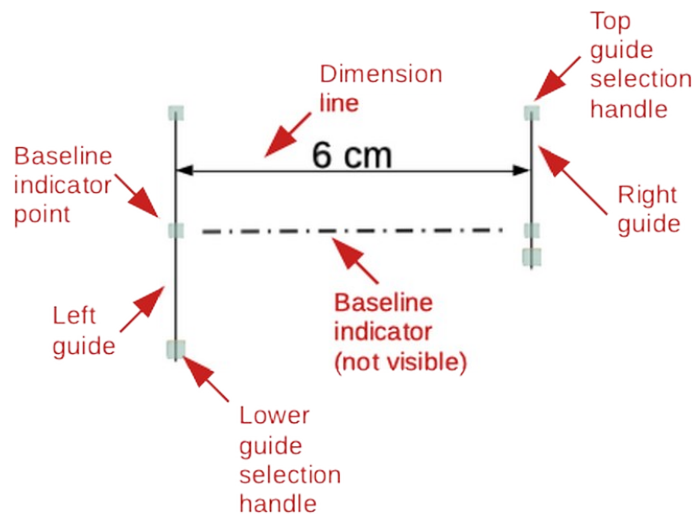

Figure 285: Example dimension line

- **Line** – sets the distances between the dimension line and guides with respect to each other, the dimension baseline and the object. The baseline is not visible in a drawing, but is indicated by baseline points on each of the guides.
 - *Line distance* – specifies the distance between the dimension line and the object or the baseline. A minimum of -10mm to a maximum of 10mm can be entered in the text box. The lower the value, the closer the dimension line is to the object or baseline.
 - *Guide overhang* – is the distance the guide either extends above the dimension line or is below the dimension line. A minimum of -10mm to a maximum of 10mm can be entered in the text box. Positive values cause the guide overhang to extend above the dimension line. Negative values cause the guide overhang to be below the baseline.
 - *Guide distance* – specifies the length of the right and left guides below the dimension line toward the object. A minimum of -10mm to a maximum of 10mm can be entered in the text box. Positive values extend the guides above the baseline and further away from the object. Negative values extend the guides below the baseline and closer to the object.
 - *Left guide* – specifies the length of the left guide starting at the dimension line. A minimum of -10mm to a maximum of 10mm can be entered in the text box. Positive values extend the guide below the dimension line toward the object. Negative values move the guide away from the object.
 - *Right guide* – specifies the length of the right guide starting at the dimension line. A minimum of -10mm to a maximum of 10mm can be entered in the text box. Positive values extend the guide below the dimension line toward the object. Negative values move the guide away from the object.
 - *Measure below object* – reverses the positions and lengths of the dimension line and guides set in Line options.
 - *Decimal places* – specifies the number of decimal places used for the display of line properties.
- **Legend** – sets the properties of the dimension text.
 - *Text position* – determines the position of the dimension text with respect to the dimension line and the guides. The *AutoVertical* and *AutoHorizontal* checkboxes must be empty before a text position can be assigned.
 - *AutoVertical* – determines the optimal vertical position for the dimension text.
 - *AutoHorizontal* – determines the optimal horizontal position for the dimension text.

- *Parallel to line* – displays, when selected, the text parallel to the dimension line or, when deselected, at 90 degrees to the dimension line.
- *Show measurement units* – shows or hides the dimension measurement units. A measurement unit can be selected from the drop-down list.

Note

The dimensioning options are linked and stored with the current work page. All the changes that made apply only to this drawing. New drawings are started with the standard properties of Draw. If the dimensioning options are to be used for future drawings, save the drawing as a template.

Guide selection handles

The guide selection handles at the top and bottom of the guides are used to extend the guides more than the limits of -10mm to 10mm. With reference to the dimension example in Figure 285, the guide selection handles are used as follows:

- **Top guide selection handles** – select either selection handle and drag the handle to increase or decrease the guide overhang of both guides.
- **Lower left guide selection handle** – select the left guide selection and drag the handle to increase or decrease of the left guide distance.
- **Lower right guide selection handle** – select the right guide selection and drag the handle to increase or decrease of the right guide distance.

Tip

When dimensioning objects, it is recommended to use the zoom function, guide lines and snap functions so dimension lines can be accurately placed on an object. See Chapter 3, Working with Objects and Object Points for more information.

Dimensioning objects

- 1) Click on the triangle ▼ next to the **Lines and Arrows** icon on the Drawing toolbar to open the Lines and Arrows pop-up toolbar (Figure 286).
- 2) Click on **Dimension Line** and the cursor changes to shape, for example to a cross. The shape depends on the computer setup.
- 3) Position the cursor at one corner of the object, then click and drag the cursor to the other corner of the object to draw the dimension line. To restrict drawing the dimension line in the horizontal or vertical direction, press and hold the *Shift* key while dragging the cursor.
- 4) Release the mouse button when the other corner of the object is reached and the dimension line is drawn with the dimension automatically added (as shown in Figure 287). The dimension line is also placed automatically on the Dimension Lines layer.
- 5) To edit the text of the dimension, double-click on an unselected dimension line to enter text edit mode and make any necessary changes. Click outside the dimension line to save the changes.
- 6) To configure the dimension line, see “Configuring dimensioning” on page 262.

Note

After editing the dimension text, entering text and then deleting text, save the drawing and reopen it to enable automatic measurements for dimensioning.

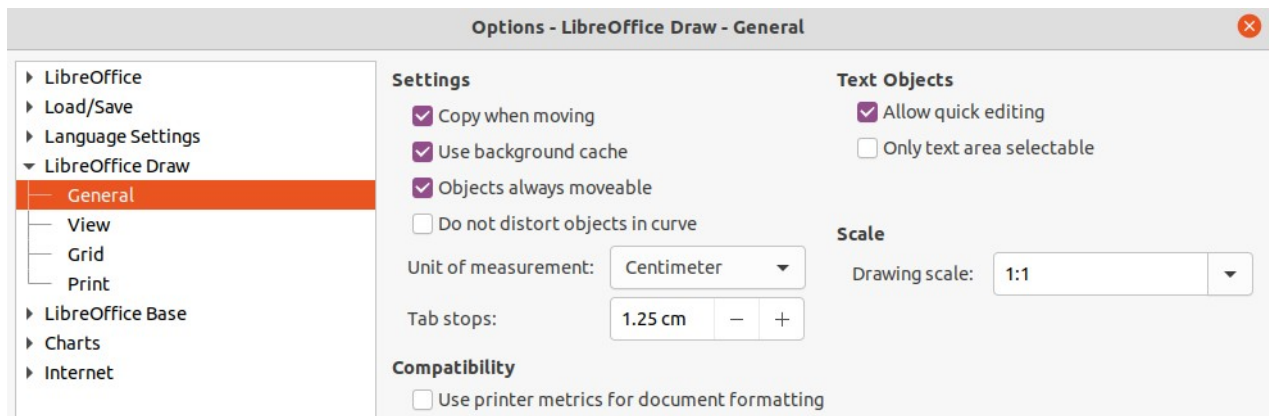

Figure 288: Options LibreOffice Draw General dialog

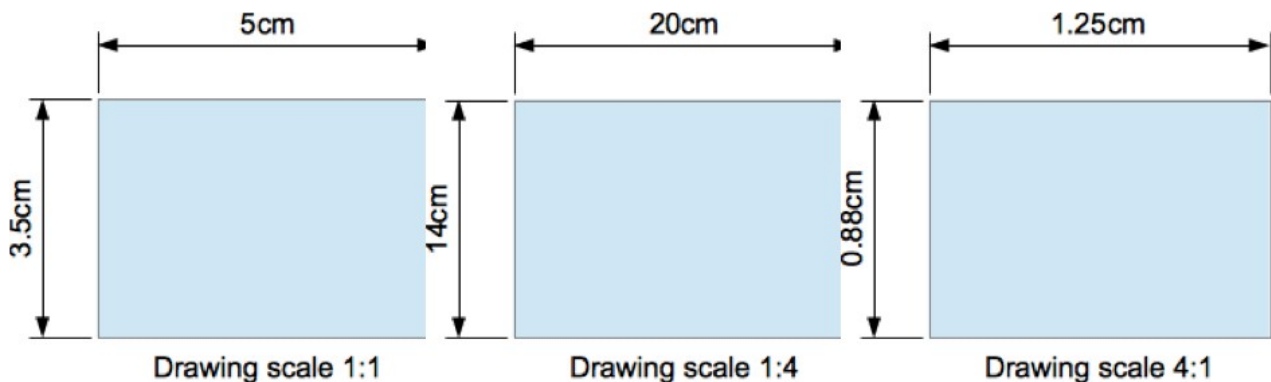

Figure 289: Examples of drawing to scale

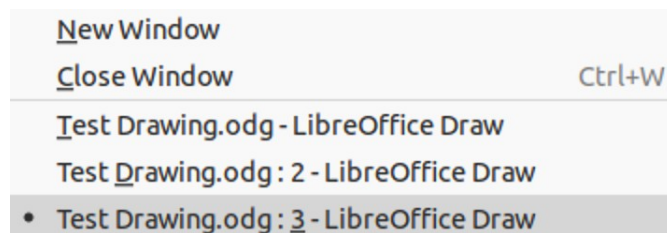

Figure 290: Example of multiple windows

Multiple views of a drawing

Several views of the same drawing can be opened and used in LibreOffice Draw. These views are displayed in windows that can use different settings for layers (visible, printable and locked), different zoom levels, different origins, or display different pages of the drawing and even use master page and normal page at the same time. However, make sure that the correct view is active when saving a drawing.

To open a new window showing the drawing, go to **Window > New Window** on the Menu bar. Arrange the windows according to the computer operating system and display preferences. Each window open acts on the same drawing. A change to the drawing in one window is immediately reflected in the other windows.

In each window opened, the filename in the title bar is automatically numbered as shown by the example in Figure 290. If other LibreOffice documents are open at the same time, the list of windows includes all the open documents. The active window has a marker by its filename in the list. Switch between windows by clicking on a name in the list, or by clicking on the window itself if it is visible on the display.

To close a window, go to **Window > Close Window** on the Menu bar, or use the keyboard shortcut *Ctrl+W*, or click on **Close** in the Menu bar of the window.

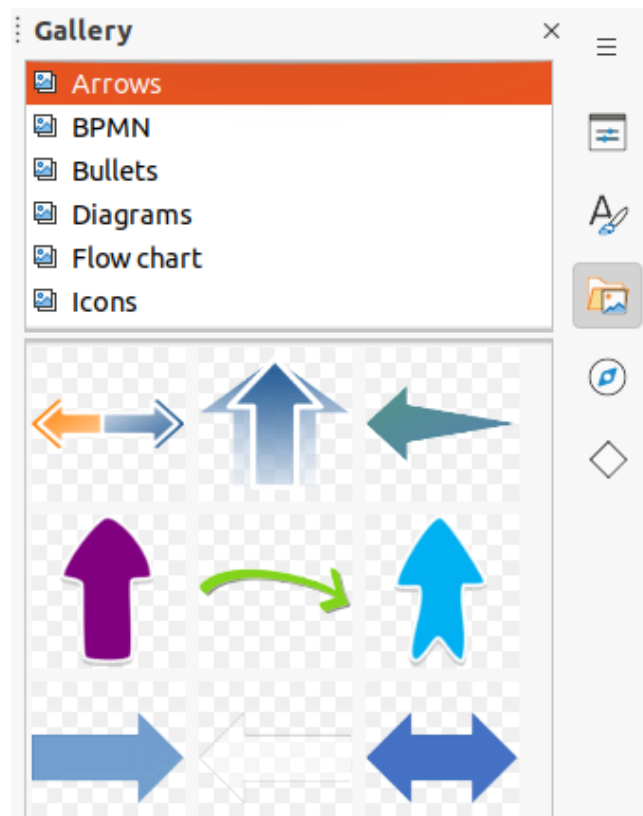

Figure 291: Arrows theme in Gallery deck on Sidebar

Gallery

Draw includes several images in the Gallery. These images are grouped into themes (for example Arrows, Bullets, Diagrams, and so on). The Gallery deck on the Sidebar (Figure 291) lists the available themes. Click on a theme and its images are displayed below the theme list.

- For a detailed view of the images in a gallery theme, click on **Detailed View** at the bottom left of the Sidebar.
- For an icon view of the images in a gallery theme, click on **Icon View** at the bottom left of the Sidebar

Using the Gallery

- 1) Click on **Gallery** on the Sidebar, or go to **Insert > Media > Gallery** on the Menu bar.
- 2) Select a theme from the available options.
- 3) Use one of the following methods to place an image into a drawing:
 - Click on an image in the Gallery deck and drag the image into a drawing.
 - Right-click on an image and select **Insert** from the context menu. The image is placed at the centre of a drawing.
 - Right-click on an image and select **Copy** from the context menu. Paste the image into the drawing and the image is placed at the center of the drawing.
- 4) Edit the gallery image to the drawing requirements. For more information on editing images and pictures, see Chapter 6, Editing Pictures.

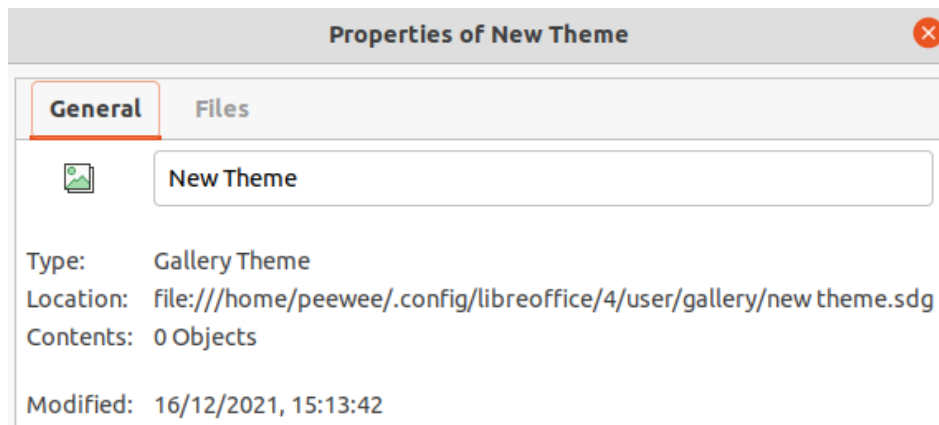

Figure 292: Properties of New Theme dialog - General page

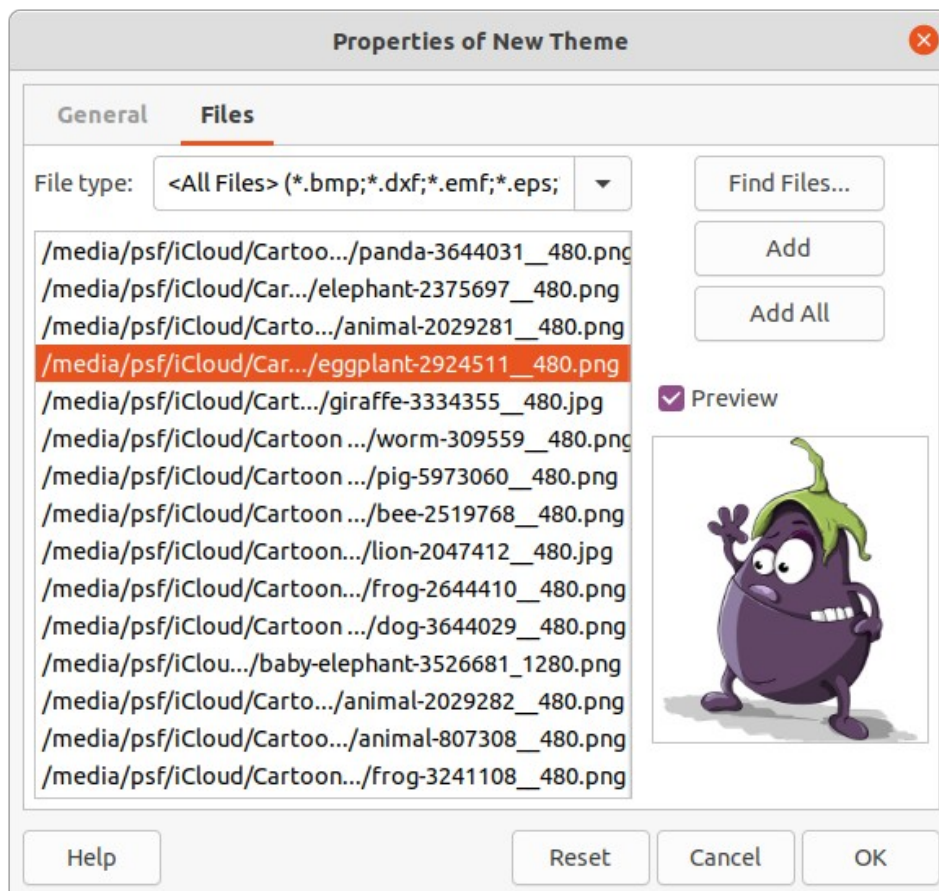

Figure 293: Properties of New Theme dialog - Files page

Creating themes and adding images

- 1) Open the Gallery deck on the Sidebar.
- 2) Click on **New** on the Gallery deck to open the Properties of New Theme dialog (Figure 292).
- 3) Enter a name for the theme in the text box.
- 4) Click on **Files** to open the **Files** page as shown by the example in Figure 293.
- 5) Click on **Find Files** to open a Select Path dialog.
- 6) Browse to the folder that contains the images required and select the folder

- 7) Click **OK** to select the files contained in the folder and the Select Path dialog closes. The list of files contained in the folder now appear in the **Files** page as shown by the example in Figure 293.
- 8) Select the files required for the new theme and click **Add**. The selected files disappear from the file list and the images appear in the Gallery.
- 9) If all the files in the list are to be added, click **Add All**. All the files disappear from the list and the images appear in the Gallery.
- 10) Click **OK** when finished adding files and close the Properties of New Theme dialog. The name of the new theme appears in the Gallery deck.

Note

If a Draw object is added to a theme, the object loses its connection to Draw graphic styles and all properties are set as direct formatting.

Deleting gallery themes and images

- 1) Right-click on a theme or image in the Gallery and select **Delete** from the context menu.
- 2) Click **Yes** in the confirmation dialog and the image or theme is deleted from the Gallery.

Note

Only themes and images that have added to Draw can be deleted. The themes and images that were included with the installation of LibreOffice cannot be deleted.

Note

An image is a linked file and only the link is deleted from the Gallery. The original image file is not deleted.

Updating the Gallery

All images in the Gallery are linked files. Occasionally, it is beneficial to update a theme that has been added to Draw to make sure that all files are still accessible. Right-click on a theme that has at least one file added to the theme and select **Update** from the context menu.

Renaming themes

To rename a theme that has been added to Draw, right-click on the theme name and select **Rename** from the context menu.

Note

Only themes and images that have added to Draw can be renamed. The themes and images that were included with the installation of LibreOffice cannot be renamed.

Colors

Draw (like all LibreOffice components) uses colors grouped into color palettes. Colors can be created to suit drawing requirements. All custom colors created are placed in the custom color palette. The following explains the color models that can be used to create a custom color.

- **RGB** – stands for Red, Green, Blue. The RGB color model is based on the additive color model of light waves and is designed for electronic displays and computers. This means, the more color added, the closer a color moves towards white. RGB is created using scales from 0 to 255. This means that black is when R=0, G=0, and B=0 and white is when R=255, G=255, and B=255. LibreOffice uses the RGB color model internally for printing in all of its software modules.
- **CMYK** – stands for Cyan, Magenta, Yellow, Key (Black). It is a subtractive color model where colors are subtracted to get to white. It is mainly used in printing, which is why the ink cartridges for a printer are labeled CMYK. CMYK works on a scale of 0 to 100. If C=100, M=100, Y=100, and K=100, the color produced is black. If C=0, M=0, Y=0, and K=0, the color produced is white.
- **HSB** – stands for Hue, Saturation, Brightness. HSB values are an alternative representation of the RGB color model and was designed to be more closely aligned with the way human vision perceives color-making attributes. Use HSB values to fine tune any custom colors that are created.

Tip

More information on color models and color values can be found at http://en.wikipedia.org/wiki/Color_model.

Changing colors

When changing colors in objects, color palettes are used to select colors. These color palettes are installed with LibreOffice and are used in all the LibreOffice modules. Using these color palettes is similar across all types of objects, but accessing the color palettes does vary according to the type of object selected.

Color Bar

Although LibreOffice includes tools that to precisely specify a color, it also includes a Color Bar (Figure 294) that allows the area fill, border, or line color of an object to be quickly changed in a drawing.

- 1) Select an object in the drawing.
- 2) Go to **View > Color Bar** on the Menu bar to open the Color Bar. When the Color Bar opens, it is labelled Color Palette.
- 3) Left click on a color to change the area fill color or right-click on a color to change the border or line color of a selected object.

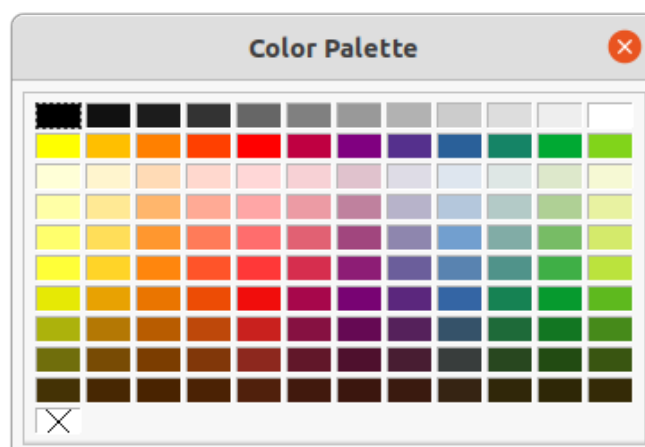

Figure 294: Color Bar (Color Palette)

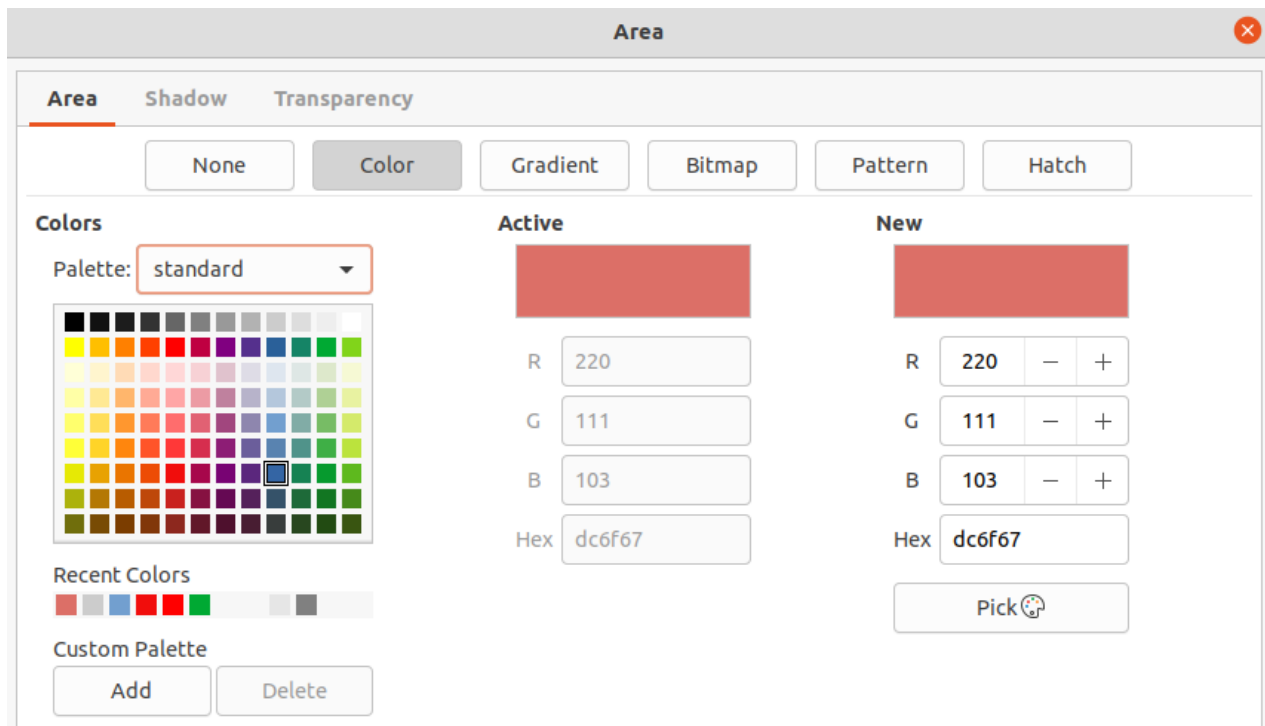

Figure 295: Area dialog - Area Color page

- 4) Left click on the X box in the bottom left corner of the Color Bar to remove the color from an object fill, or right-click on the X box in the bottom left corner of the Color Bar to remove the color from an object border,
- 5) To close the Color Bar, go to **View > Color Bar** on the Menu bar and deselect Color Bar.

✓ Note

The colors available in the Color Bar are from the **Standard** color palette that is part of the LibreOffice installation.

Area dialog

- 1) Select an object in the drawing.
- 2) Open the Area dialog (Figure 295) using one of the following methods:
 - Go to **Format > Area** on the Menu bar.
 - Right-click on the object and select **Area** from the context menu.
- 3) Click on **Area**, then click on **Color** to open the **Color** page.
- 4) In **Colors**, select a color palette from the *Palette* drop-down list.
- 5) Click on a color from the ones displayed in the color palette, or select a color that has been previously used from *Recent Colors*.
- 6) Click **OK** to save the changes and close the Area dialog. The selected fill color appears in the selected object.

Area panel on the Sidebar

- 1) Select an object in the drawing.
- 2) Open the **Area** panel in the Properties deck on the Sidebar (Figure 296).
- 3) Select *Color* from the **Fill** drop-down list.
- 4) Click on the triangle ▼ on the right of **Fill Color** to open the palette last used.

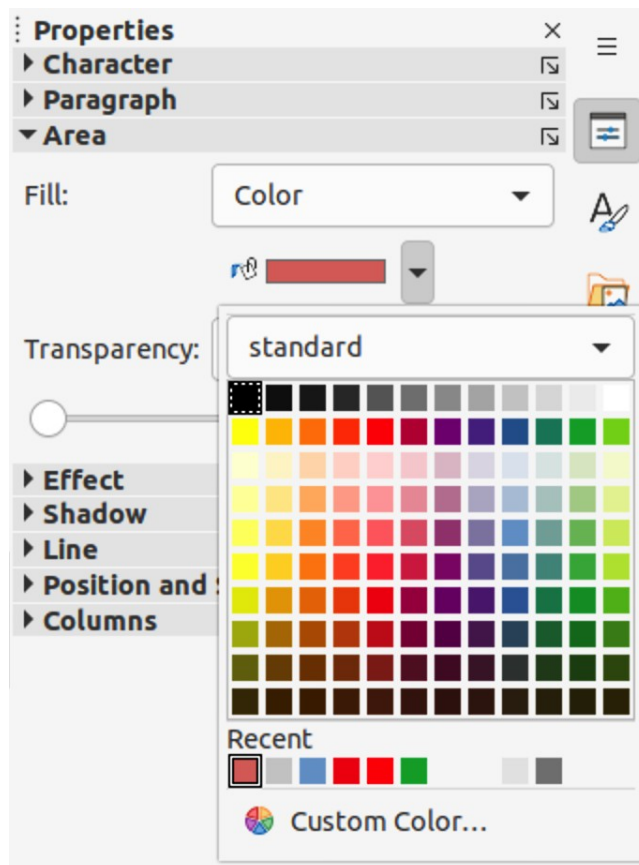

Figure 296: Area panel in Properties deck on Sidebar

- 5) Select a color palette to use from the palette drop-down list.
- 6) Click on a color from the colors displayed in the color palette, or select a color that has been previously used from those displayed in *Recent*. The color palette closes and the selected fill color is applied to the object.

Fill Color on the Line and Filling or Drawing toolbars

- 1) Select an object in the drawing.
- 2) Click on the triangle ▼ to the right of **Fill Color** on the Line and Filling or Draw toolbar to open the last color palette used.
- 3) Select a color palette to use from the palette drop-down list.
- 4) Click on a color from the colors displayed in the color palette, or select a color that has been previously used from those displayed in *Recent*. The color palette closes and the selected fill color is applied to the selected line.

Line dialog

- 1) Select a line or an object in the drawing.
- 2) Open the Line dialog (Figure 297) using one of the following methods:
 - Go to **Format > Line** on the Menu bar.
 - Right-click on the line or object and select **Line** from the context menu.
- 3) Click on **Line** to open the **Line** page.
- 4) Click on the triangle ▼ to the right of **Color** to open the last color palette used.
- 5) Select a color palette to use from the palette drop-down list.

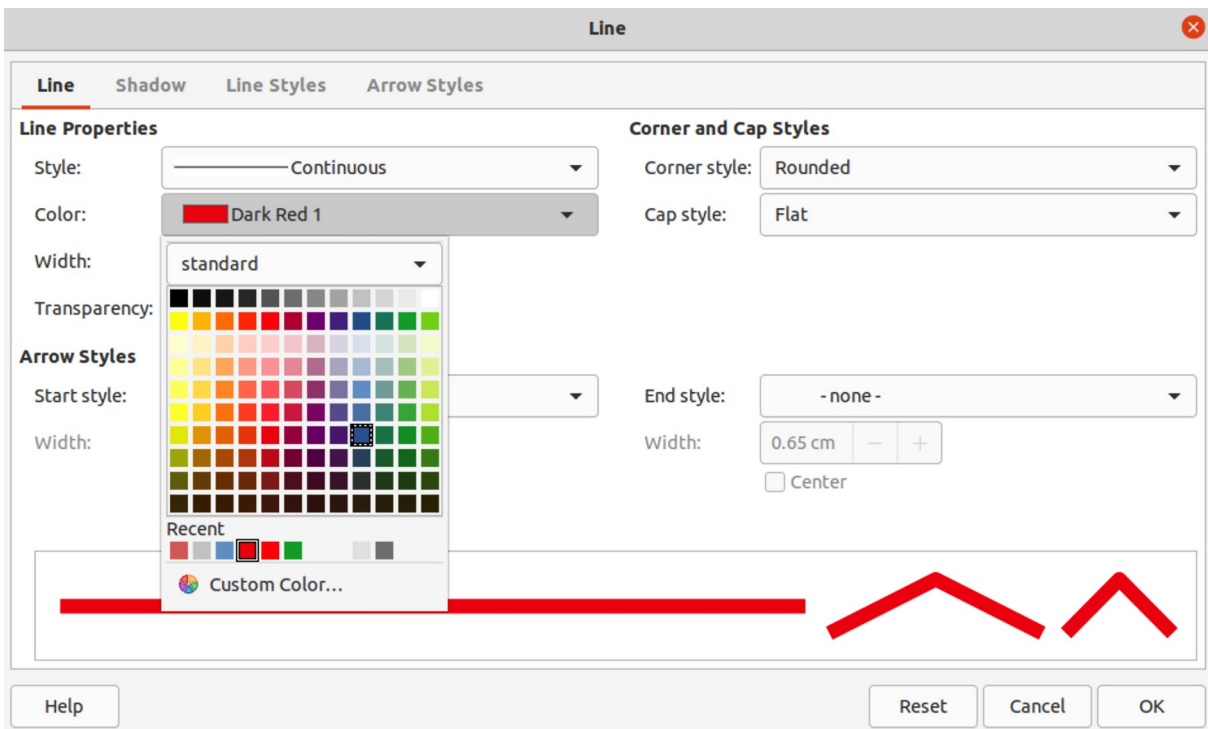

Figure 297: Line dialog - Line page - Color

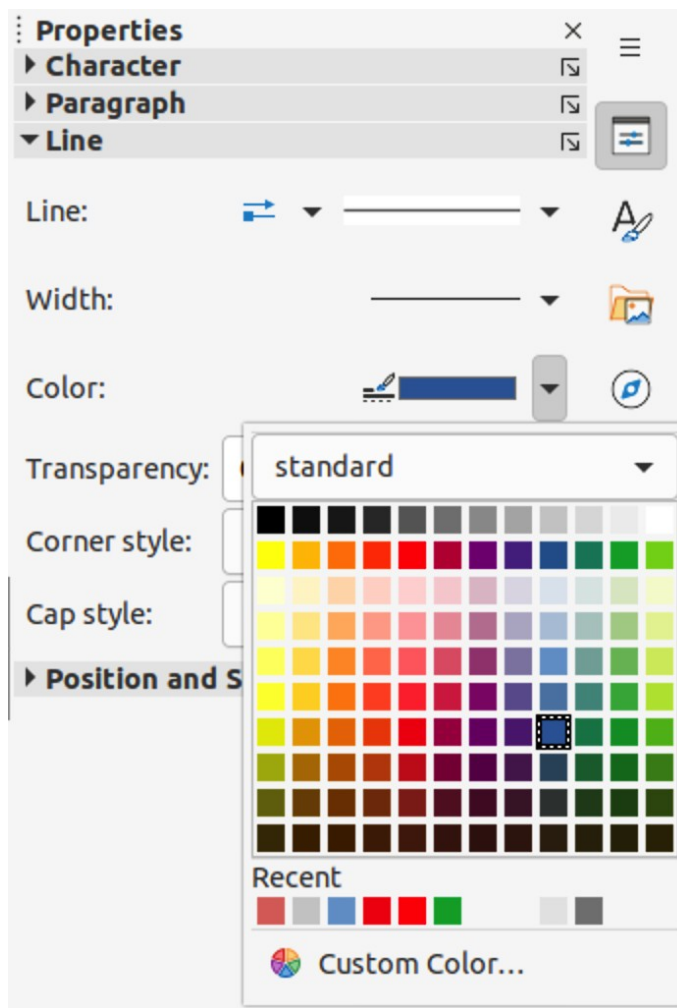

Figure 298: Line panel in Properties deck on Sidebar

- 6) Click on a color from the colors displayed in the color palette, or select a color that has been previously used from those displayed in *Recent*. The color palette closes and the selected line color is applied to the line or object border.
- 7) Click **OK** to save the color change and close the Line dialog.

Line panel on the Sidebar

- 1) Select a line or an object in the drawing.
- 2) Open the *Line* panel in the Properties deck on the Sidebar (Figure 298).
- 3) Click on the triangle ▼ to the right of **Color** to open the palette last used.
- 4) Select a color palette to use from the palette drop-down list.
- 5) Click on a color from the colors displayed in the color palette, or select a color that has been previously used from those displayed in *Recent*. The color palette closes and the selected line color is applied to the line or object border.

Line Color on the Line and Filling or Drawing toolbars

- 1) Select a line or object in the drawing.
- 2) Click on the triangle ▼ to the right of **Line Color** on the Line and Filling or Draw toolbar to open the last color palette used.
- 3) Select a color palette to use from the palette drop-down list.
- 4) Click on a color from the colors displayed in the color palette, or select a color that has been previously used from those displayed in *Recent*. The color palette closes and the selected line color is applied to the line or object border.

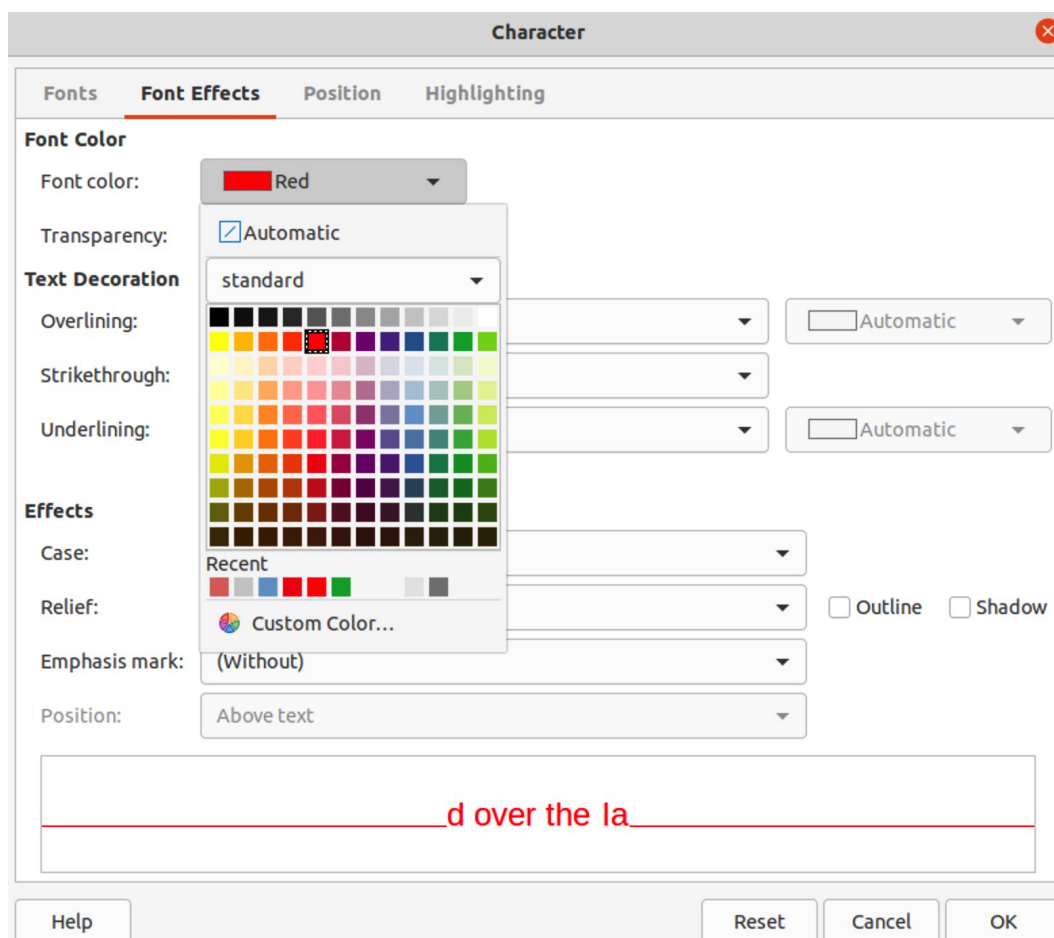

Figure 299: Character dialog - Font Effects page - Color

Changing text color

Changing text color is very similar to changing the color of an area fill, object border, or line. The Text Formatting toolbar automatically opens and replaces the Line and Filling toolbar when text is selected in a drawing. If the Text Formatting toolbar does not appear, go to **View > Toolbars** on the Menu bar and select **Text Formatting**.

Character dialog

- 1) Select the text in a text box or object and make sure the text is highlighted.
- 2) Open the Character dialog (Figure 299) using one of the following methods:
 - Go to **Format > Character** on the Menu bar.
 - Right-click on the highlighted text and select **Character** from the context menu.
- 3) Click on **Font Effects** to open the **Font Effects** page.
- 4) Click on the triangle ▼ to the right of **Font Color** to open the last color palette used.
- 5) Select a color palette to use from the palette drop-down list.
- 6) Click on a color from the colors displayed in the color palette, or select a color that has been previously used from those displayed in *Recent*. The color palette closes and the selected color is applied to the selected text.
- 7) Click **OK** to save the color change and close the Character dialog.

Character panel on the Sidebar

- 1) Select the text in a text box or object and make sure the text is highlighted.

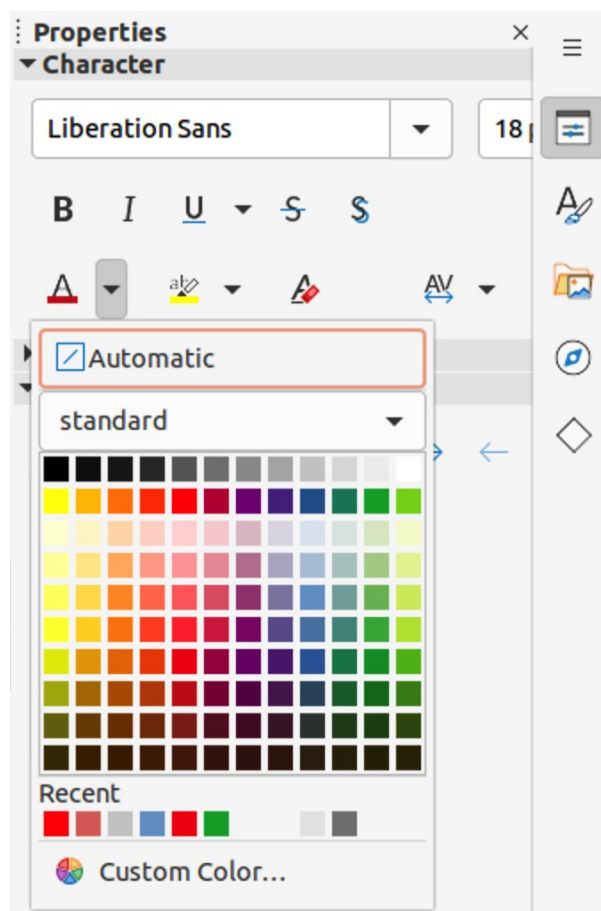

Figure 300: Character panel in Properties deck on Sidebar

- 2) Open the *Character* panel in the Properties deck on the Sidebar (Figure 300).
- 3) Click on the triangle ▼ to the right of **Font Color** to open the color palette last used.
- 4) Select a color palette to use from the palette drop-down list.
- 5) Click on a color from the colors displayed in the color palette, or select a color that has been previously used from those displayed in *Recent*. The color palette closes and the selected color is applied to the selected text.

Creating colors

Using *Pick a Color dialog*

- 1) Select the object or text and open the Pick a Color dialog (Figure 301) using one of the following methods:
 - Open the Area dialog, then click on **Color** to open the **Color** page and click on **Pick**.
 - Open the Area section in Properties deck on the Sidebar, click on the triangle ▼ to the right of **Fill Color** to open the color palette and click on **Custom Color** at the bottom of the color palette.
 - Open the Line dialog, then open a color palette in **Color** and click on **Custom Color** at the bottom of the color palette.
 - Open the Line section in Properties deck on the Sidebar, click on the triangle ▼ to the right of **Line Color** to open the color palette and click on **Custom Color** at the bottom of the color palette.
 - Open the Character dialog, then open a color palette in **Font color** and click on **Custom Color** at the bottom of the color palette.

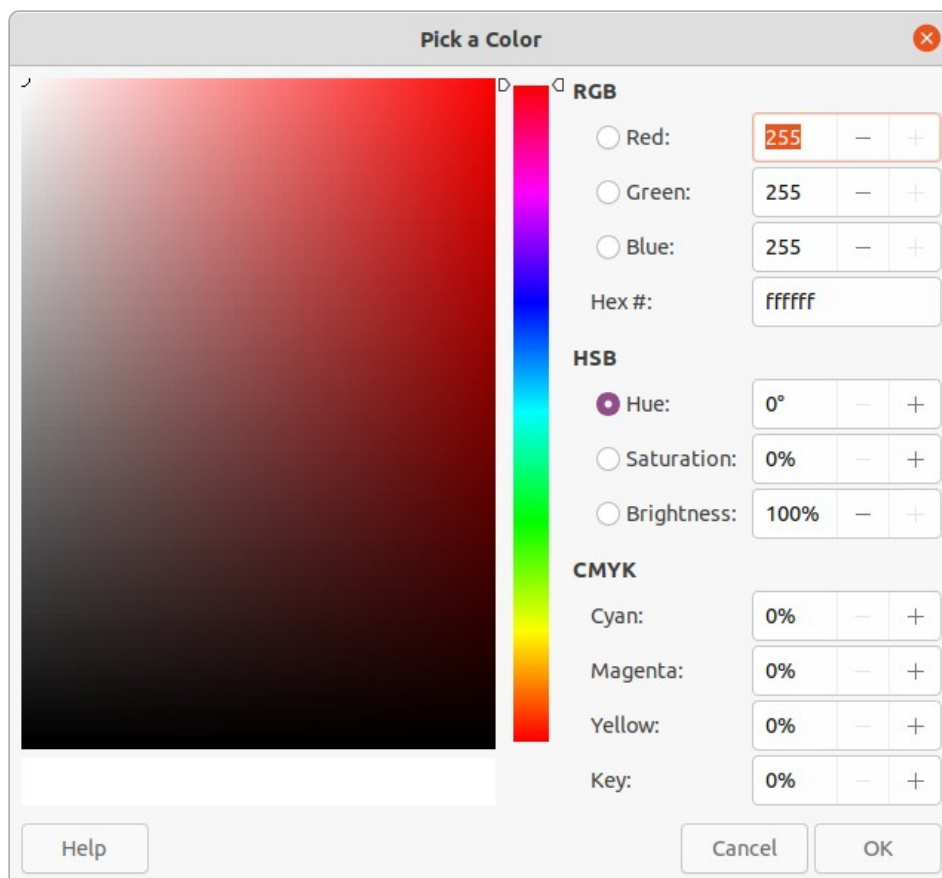

Figure 301: *Pick a Color dialog*

- Open the *Character* section in Properties deck on the Sidebar, click on the triangle ▼ to the right of **Font Color** to open the color palette and click on **Custom Color** at the bottom of the color palette.
- 2) Select a color range in the vertical color bar on in the Pick a Color that approximately matches the custom color being created.
 - 3) Click and drag the small target circle in the color box until the color matches the custom color required. The values for RGB, HSB and CMYK change as the small target circle is dragged around the color box. This helps in creating the exact color if these color values are known.
 - 4) Alternatively, if the color values or hex number are known, enter these values in the appropriate text box. The values in all the text boxes changes to match the new values. For example, enter HSB values, the RGB, CMYK and Hex values also change to match.
 - 5) Click **OK** to save the changes and close the Pick a Color dialog.

✓ Note

When using the Line or Character dialog to open the Pick a Color dialog, the custom color created cannot be saved into the Custom color palette or renamed with a more meaningful name. The custom color created is named using the hex value that is displayed in the Pick a Color dialog. Only the Area dialog has the ability to rename custom colors and save custom colors into the Custom palette.

✓ Note

LibreOffice uses the RGB color model for printing in color. The RGB values of a selected color are displayed below the preview boxes.

Using Area dialog

- 1) Open the Area dialog and click on **Color** to open the **Color** page.
- 2) In **New**, enter the RGB values or, if known, the Hex value into the text boxes. The color changes in the preview box to match the values entered.
- 3) Alternatively, in **New**, use the minus and plus signs for the RGB values to decrease or increase the values. The color changes in the preview box to match the values entered.
- 4) Click **OK** to change the color and close the Area dialog.

Adding custom colors

If necessary, add a custom color to the **Custom** color palette using the Area dialog as follows:

- 1) Make sure the Area dialog is open at the **Color** page.
- 2) Select the custom color that is displayed in *Recent Colors*.
- 3) Click on **Add** to open a Name dialog.
- 4) Enter a new name for the color in the text box,
- 5) Click **OK** to save the changes and close the Name dialog. The custom color appears in the **Custom** palette.
- 6) Click **OK** to close the Area dialog.

Renaming custom colors

Only a custom color can be renamed using the Area dialog as follows:

- 1) Make sure the Area dialog is open at the **Color** page.

- 2) Select the custom color that is displayed in the **Custom** color palette.
- 3) Click on **Add** to open a Name dialog.
- 4) Enter a new name for the color in the text box,
- 5) Click **OK** to save the changes and close the Name dialog. The custom color appears in the **Custom** palette.
- 6) Click **OK** to close the Area dialog.

✓ Note

Renaming a custom color does not actually rename the custom color, but adds the custom color to the **Custom** palette with a new name.

✓ Note

It is important to use a memorable names for custom colors so that they can be easily recognized in the Custom palette. By default, a custom color is given a hex number, which makes it difficult identifying colors when there is more than one custom color.

Deleting custom colors

Only a custom color can be deleted using the Area dialog as follows:

- 1) Make sure the Area dialog is open at the **Color** page.
- 2) Select the custom color that is displayed in the **Custom** color palette.
- 3) Click on **Delete**. There is no confirmation given when deleting custom colors.
- 4) Click **OK** to close the Area dialog.

Bézier curves

In LibreOffice, Bézier² curves can be used in a drawing. A curve is defined by means of a start point, an end point, and, where necessary, control points. For points on the curve the terms nodes or anchors are often used. For more information and an explanation of the mathematical background of Bézier curves, see http://en.wikipedia.org/wiki/Bezier_curve.

Bézier curves are very useful for experimenting with the shape and form of curves. In point mode the curve alignment can be changed by dragging the points with the cursor. In the example shown in Figure 302, the curve leaves the start point P0 in the direction of the first control point P1 and arrives at the end point P3 from the direction of the second control point P2. The more distant a control point is from the start or end point, the smaller the curvature at that point.

Drawing Bézier curves

- 1) Click on **Curve** in the Curves and Polygons section in the Shapes deck on the Sidebar or in the Drawing toolbar.
- 2) Click at the start point for the curve and drag the cursor to the approximate position of the end point for the curve.
- 3) Release the mouse button and drag the end point of the curve to its end position.
- 4) Double-click when the end position of the curve is reached and a curve is drawn. The arc of the curve is determined by the distance dragged to create the end point.

2 Bézier curves were invented by Pierre Bézier, an engineer working with the Renault car manufacturer, who developed the technique in the 1960s. The technology was intended to make modeling the surface of vehicles easier.

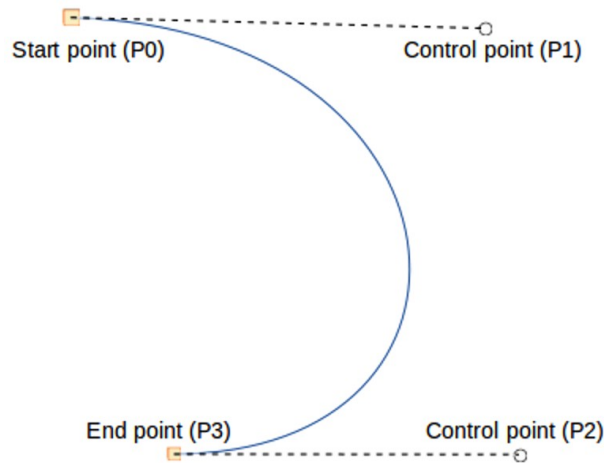

Figure 302: Example of a Bézier curve



Figure 303: Edit Points toolbar

- 5) Switch to points mode using one of the following methods:
 - Go to **Edit > Points** on the Menu bar.
 - Click on **Points** on the Standard toolbar.
 - Use the keyboard shortcut *F8*.
- 6) Open the Edit Points toolbar (Figure 303) using one of the following methods. The Edit Points toolbar does not become visible until a point has been selected on a curve.
 - Go to **View > Toolbars** on the Menu bar and select **Edit Points**.
 - Click on **Points** on the Standard toolbar.
 - Use the keyboard shortcut *F8*.
 - If added to the toolbar, click on **Points** on the Drawing toolbar.
- 7) Click once on the curve to display the start and end points. The start point of the curve is larger than the end point.
- 8) Click on a start or end point to display the control points. Control points appear at the end of a dashed line connected to the selected point, as shown in Figure 302.
- 9) Click on the control point and drag it to a new position to change the shape of the curve.
- 10) When the shape of the curve is correct, release the mouse button to fix the curve.
- 11) Click anywhere on the workspace to deselect the curve and stop editing points.

Edit Points tools

After the initial opening of the Edit Points toolbar, when an object is selected that has been converted to a curve or polygon, the toolbar is displayed. The tools available on the Edit Points toolbar allow the editing of a Bézier curve and changing of the curve shape. A point on a Bézier curve has to be selected for all the tools on the Edit Points toolbar to become available.

- **Move Points** – click and drag on a point to move it to another location.
 - The curve on both sides of the point follows the movement and changes shape as the selected point changes position.

- Click and drag on the curve between points to move the entire curve without distorting the form.
- **Insert Points** – activates the insert mode when selected and inserts smooth points onto a curve. Insert mode remains active after inserting points. Select **Move Points** to deactivate insert mode.
 - The inserted point can be moved while insert mode is activated.
 - If a corner or symmetrical point is required, insert a smooth point first and convert the point to a corner or symmetrical point.
- **Delete Points** – deletes selected points. If several points are to be deleted, hold down the *Shift* key whilst selecting points and before clicking on **Delete Points**.
- **Convert To Curve** – converts a curve into a straight line or a straight line into a curve as shown in Figure 304.
 - Select a single point and the curved segment after the point converts to a straight line, or converts a straight line segment to a curve after the point.
 - When converting a segment from a curve to a straight line, each point at each end of the segment becomes a control point similar to the start or end point.
 - When converting a segment from a straight line to a curve, each control point at each end of the segment becomes a smooth point.



Figure 304: Example of converting a curved segment to a line

- **Close Bézier** – closes a freeform line or curve by connecting the start point with the end point creating an object with area fill.
- **Split Curve** – splits a curve into two or more curves. Select a point or points and click on Split Curve to create separate segments of a curve. Deselect the curve, then select a segment to move or edit it.
- **Corner Point** – converts a selected point into a corner point, as shown in Figure 305. Corner points have two movable control points, which are independent from each other, and allows a corner to be created in a curve.

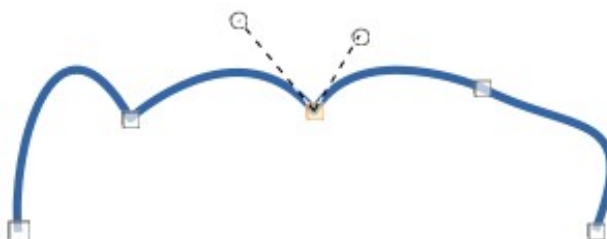

Figure 305: Example of a corner point

- **Smooth Transition** – converts a corner or symmetrical point into a smooth point, as shown in Figure 306. Both control points of a smooth transition point are aligned in parallel and can only be moved simultaneously. The control points may differ in length, allowing the degree of curvature to be varied.



Figure 306: Example of a smooth transition point

- **Symmetric Transition** – converts a corner point or a smooth point into a symmetrical point, as shown in Figure 307. Both control points of a symmetrical transition point are aligned in parallel and have the same length. These control points can only be moved simultaneously and the degree of curvature is the same in both directions.



Figure 307: Example of a symmetrical transition point

- **Eliminate Points** – allows selection of several points before using the **Delete Points** tool. This is useful when deleting a straight line segment to create a complete curve.

Adding comments to a drawing

Draw supports comments similar to those in Writer and Calc. For more about adding, navigating, and replying to comments, see the *Getting Started Guide* for more information. Comments in Draw cannot be printed. To reply to a comment in Draw, a new comment has to be added.

- 1) Go to **Insert > Comment** on the Menu bar and a comment box (Figure 308) appears in the upper left-hand corner of a drawing. Draw automatically adds the user name and date at the bottom of the comment and places a comment marker on the drawing page.
- 2) Type or paste a comment into the comment text box.
- 3) To apply basic formatting to the text, right-click on the text and select the formatting option from the context menu.
- 4) To delete a comment, use one of the following methods:
 - Right-click in the comment box and select a delete option from the context menu.
 - Right-click on the comment marker and select a delete option from the context menu.
 - Click on the triangle ▼ in the bottom right of the comment box and select a delete option from the context menu.
- 5) To move a comment, click on the comment marker and drag it to a new position.
- 6) To hide comments, use one of the following methods:
 - Go to **View** on the Menu bar and deselect **Comments** to hide the comment and the comment marker.
 - Click on the drawing outside of the comment to hide the comment. The comment marker remains visible.
- 7) To show comments, go to **View > Comments** on the Menu bar and click on the comment marker.

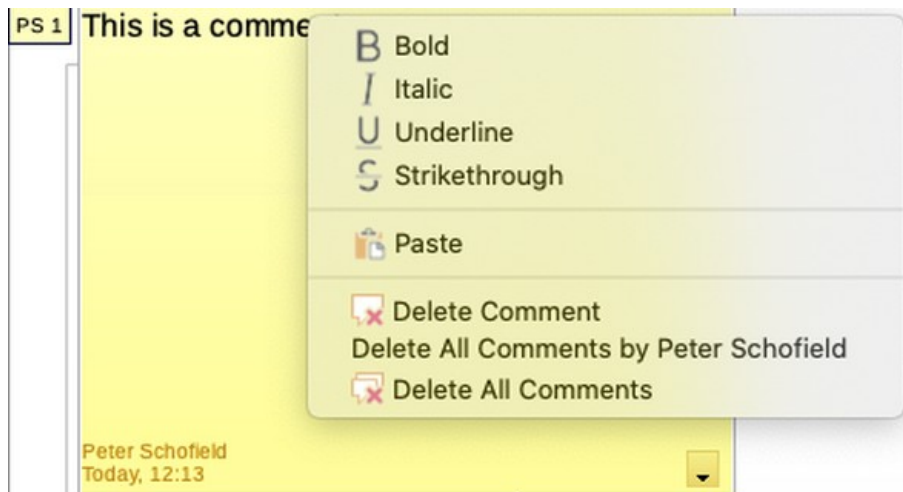

Figure 308: Comments in Draw

✓ Note

For the user name and initials to appear in a comment, enter the user data in **Tools > Options > LibreOffice > User Data** dialog. If more than one person edits the document, each author is automatically allocated a different background color.

Coordinate system

X and Y axes

The x-axis is the horizontal position of an object and the y-axis is the vertical position of an object. The rulers do not show a minus sign if there are negative coordinates. However, the minus sign for negative coordinates is shown in the position field in the **Status Bar** and the Position and Size dialog.

Workspace

The **Workspace** in Draw is larger than the drawing page. The area outside the drawing page is one page width right and left and a half page above and below the drawing page. The size of the drawing page is indicated by highlighted portions in the horizontal and vertical rulers.

Draw objects can be drawn partly or wholly outside the drawing page and these objects are saved with the drawing. However, when the drawing is printed or exported, any object or portion of an object not on the drawing page is not included. This allows the **Workspace** area around the drawing page to be used for drafts when creating objects.

Object position

The coordinates of objects and snap guides are shown relative to the origin. The default origin for coordinates (0.00/0.00 position) is the top-left corner of the drawing page without margins or the top left corner of the drawing page where the margins intersect. To change the default origin, click and drag the intersection of the rulers in the top left corner of the **Workspace** to the desired position. Guide lines appear as the intersection is dragged from its default origin to its new position. This origin setting is only for the current view and is not saved in the document.

The area inside the default origin is the area used for the grid when the option **Snap to Grid** and **Display Grid** are selected.

To reset the default origin back to its original setting at the top-left corner of the page, double-click in the top-left corner on the **Workspace** where the horizontal and vertical rulers meet.

Accuracy

Draw internally uses integer values in 1/100 mm. Therefore, for example, it is not possible to get an exact position for 1/8 inch. Also, many dialog fields are restricted to two decimals.

To work with the maximum possible accuracy, go to **Tools > Options > Draw > General** and set the option **Unit of measurement** to *Millimeter*. The rulers will show metric units after this option has been selected. To use another measurement unit for the rulers, right-click on a ruler and select the measurement unit from the context menu. The horizontal and vertical rulers can have different measurement units.



LibreOffice
Community



Draw Guide 7.2

Chapter 12

User Interface Variants

Introduction

By default, commands and tools used in LibreOffice Draw are grouped in a user interface consisting of cascading menus and toolbars. The functions and use of these cascading menus and toolbars are described in previous chapters of this user guide.

This chapter describes the user interface variants that are available for LibreOffice Draw. A user then has the option to select the user interface that suits their requirements and methods of creating drawings in LibreOffice Draw.

✓ Note

When changing the user interface, the variant can be applied only to LibreOffice Draw, or applied to all the modules in LibreOffice.

Selecting user interface

To select a user interface variant or switching between the user interface variants:

- 1) Go to **View > User Interface** on the Menu bar to open the Select Your Preferred User Interface dialog (Figure 309).
- 2) In **UI variants**, select one of the variants. An example of the selected variant is shown in the **Preview** box, along with a short description.
- 3) Click on **Apply to Draw** to apply the variant selection to LibreOffice Draw only, or click on **Apply to All** to apply the variant to all the LibreOffice modules. The LibreOffice window changes to match the selected variant.
- 4) Click **Close** to close the dialog.

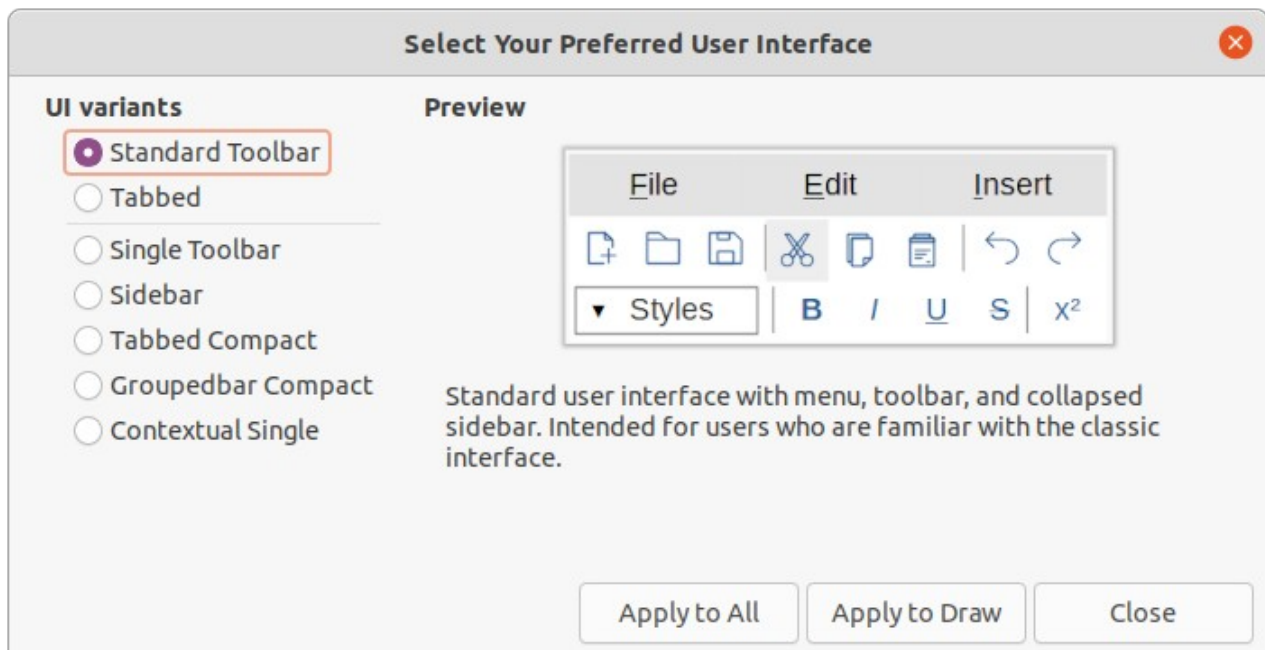

Figure 309: Select Your User Preferred User Interface dialog

✓ Note

If the option **Enable experimental features** has been selected in the **Tools > Options > Advanced** dialog, several more variants appear in **UI variants**. Being experimental, these variants are not described in this user guide.

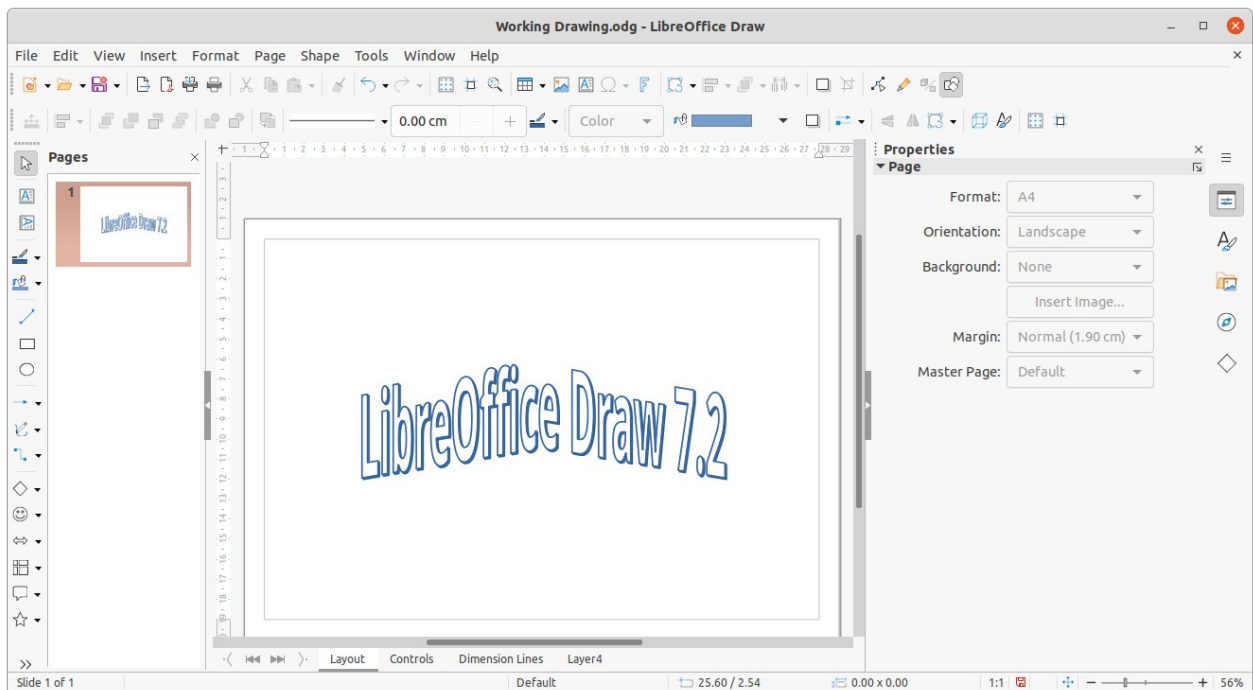

Figure 310: Standard Toolbar user interface in LibreOffice Draw 7.2

✓ Note

In all the user interface variants, the Sidebar can be hidden or shown by clicking on the **Hide/Show** button on the left of the Sidebar,

Standard Toolbar UI

The **Standard Toolbar** user interface is the default view when LibreOffice is installed and the **Workspace** opened for the first time. Figure 310 shows an example of the default **Workspace** view in LibreOffice Draw, which normally consists of the following.

- Menu bar at the top of the **Workspace**.
- Standard toolbar positioned below the Menu bar.
- Line and Filling toolbar positioned below the Standard toolbar.
- Drawing toolbar positioned vertically on the left of the Workspace.
- Sidebar positioned on the right of the **Workspace**.

For more information on the Draw **Workspace**, see Chapter 1, Introducing Draw.

Tabbed UI

The **Tabbed** user interface provides a familiar interface for users coming from proprietary office suites, for example Microsoft Office. This user interface is divided into tabs, where each tab displays a set of tools grouped by context. The context changes depending on the object selected and the LibreOffice module being used.

It includes a Menu bar, a Tab bar, and tool icons grouped in context that would be normally used in LibreOffice Draw. If the tool icons on a tab page do not fit into the width of the Draw window, a double chevron >> appears at the right end of the row. Click the double chevron >> to display more commands.

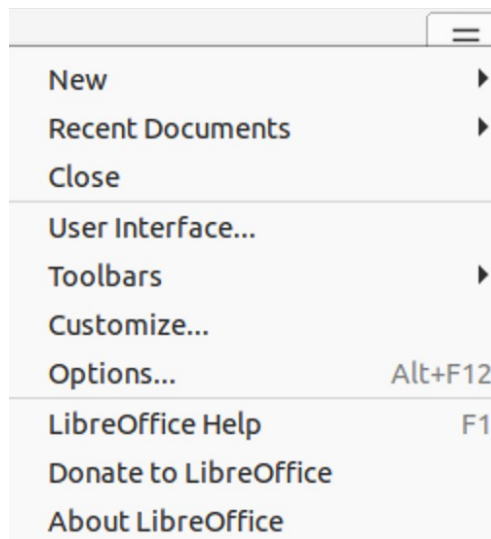

Figure 311: Quick menu options



Figure 312: Icon bar

On Windows and Linux operating systems, the Menu bar can be hidden or displayed by clicking on **Menubar** at the left end of the Tab bar.

On the right of the Tab bar, a Quick menu (≡) (Figure 311) is available giving access to some commonly used commands and links. Some of the Quick menu items have submenus, indicated by a triangle ► on the right. The Quick menu is the same for all tabs.

On the left of the Tab bar, an icon bar (Figure 312) is available giving access to some commonly used tools – **Menu bar; Open (Ctrl+O); Save (Ctrl+S); Undo (Ctrl+Z); Redo (Ctrl+Y)**.

The Tabbed user interface can be customized using the **Notebookbar** page of the Customize dialog to show or hide the individual tools on the various tabs. For more information on customization of LibreOffice, see the *Getting Started Guide* and the *Writer Guide*.

✓ Note

When using the Tabbed user interface, the Draw toolbars are removed from view. If it is necessary, toolbars can be opened and used by going to **View > Toolbars** on the Menu bar or **Quick menu > Toolbars**.

Fixed tabs

The fixed tabs in the **Tabbed** user interface for Draw are described on the following pages. The illustrations show the left and right ends of the tabs separately so they are large enough to more easily see the commands.

File tab

The **File** tab (Figure 313) is a fixed tab providing commands to create new documents; open, save, print, and close documents; manage templates; export to PDF and EPUB; display document properties; add a digital signature; and sign an existing PDF.

The **File** tab has two menus (Figures 314 and 315): **File** and **Help**. The **File** tab menu contains the same commands as the tools available on the tab. The **Help** tab menu provides links to a variety of resources.

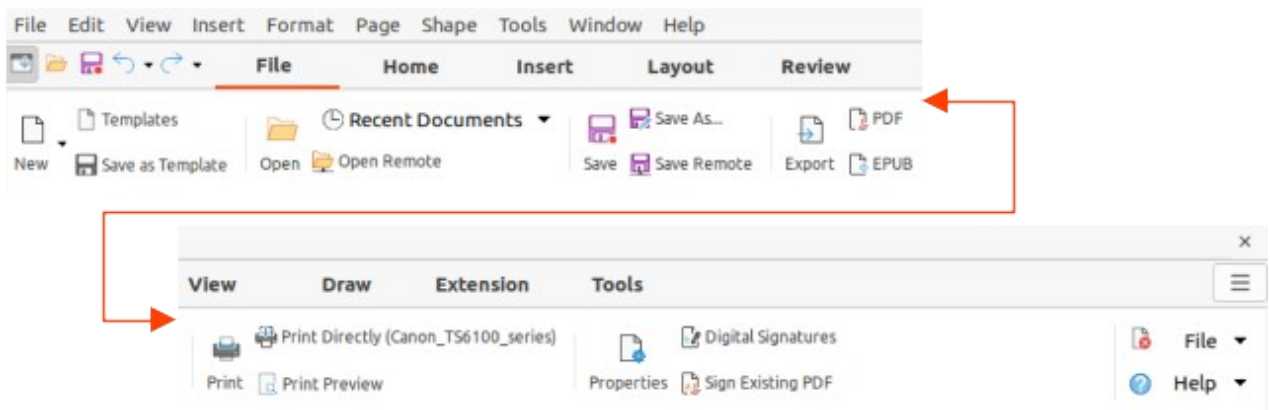

Figure 313: Tabbed user interface - File tab

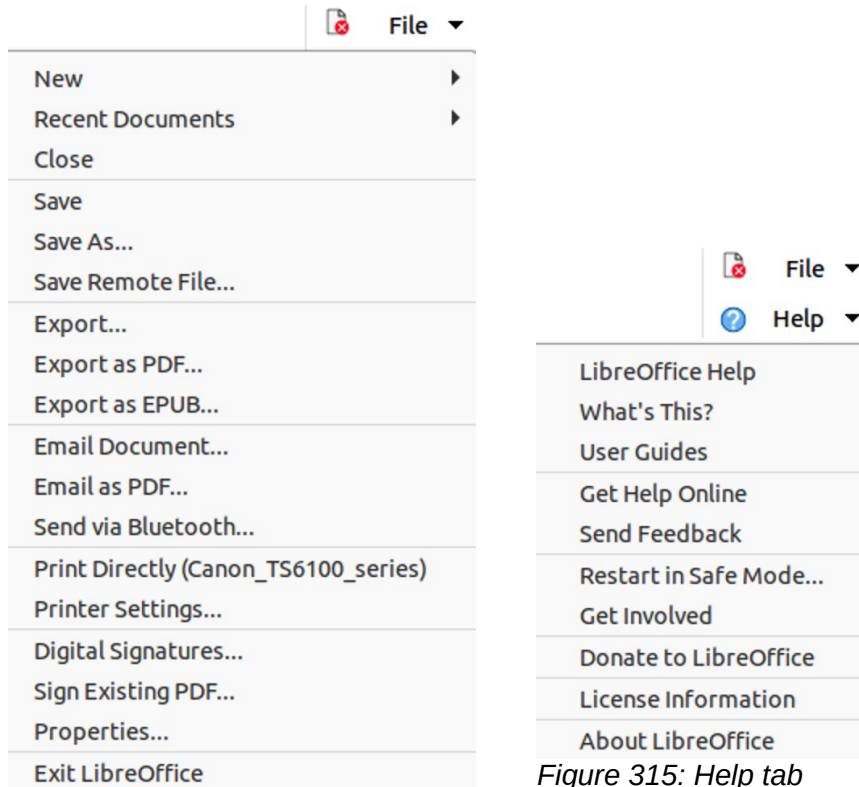

Figure 314: File tab menu

Figure 315: Help tab menu

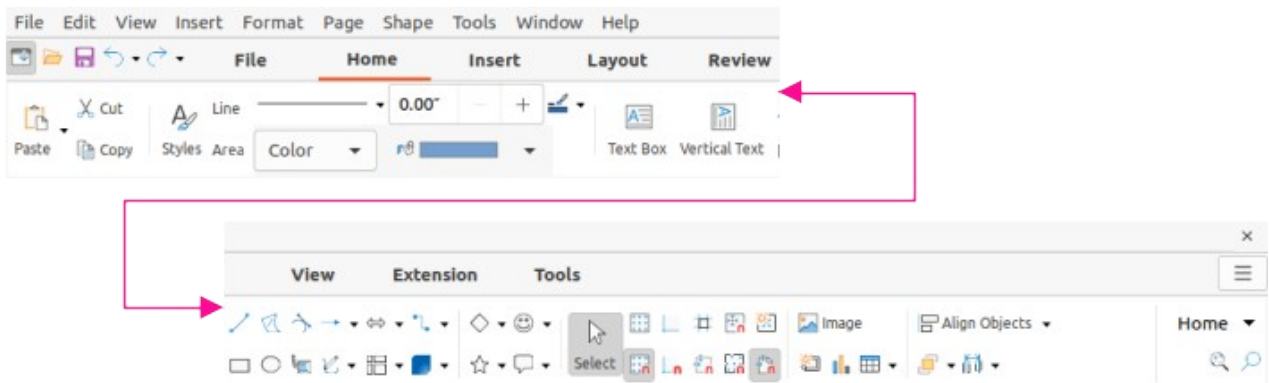

Figure 316: Tabbed user interface - Home tab

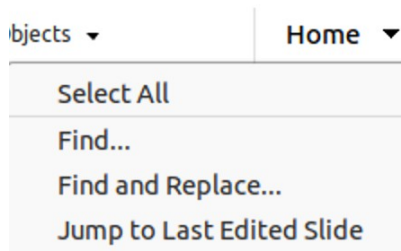

Figure 317: Home tab menu

Home tab

The **Home** tab (Figure 316) is a fixed tab providing commands to cut, copy, paste, and format text; insert common items (for example images, tables, charts); apply, update, and edit drawing styles; and so on. The **Home** tab menu (Figure 317) at the right end of the Tab bar provides additional commands that are not on the tab.

Insert tab

The **Insert** tab (Figure 318) is a fixed tab providing commands to insert many commonly used items. The **Insert** tab menu (Figure 319) at the right end of the Tab bar provides some of the same commands.

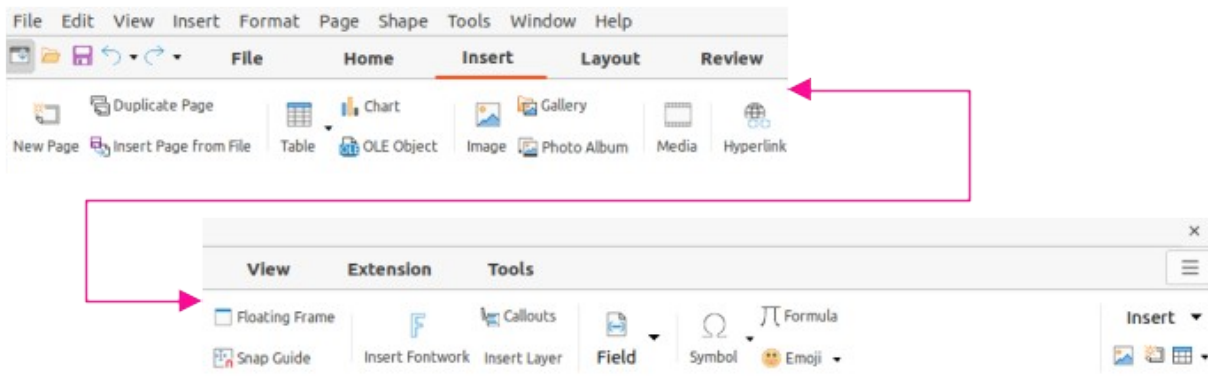

Figure 318: Tabbed user interface - Insert tab

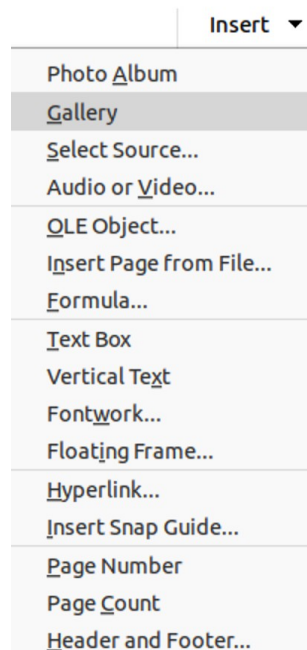

Figure 319: Insert tab menu

Layout tab

The **Layout** tab (Figure 320) is a fixed tab providing commands to create the drawing page layout. The **Layout** tab menu (Figure 321) provides extra commands to create the drawing page layout.

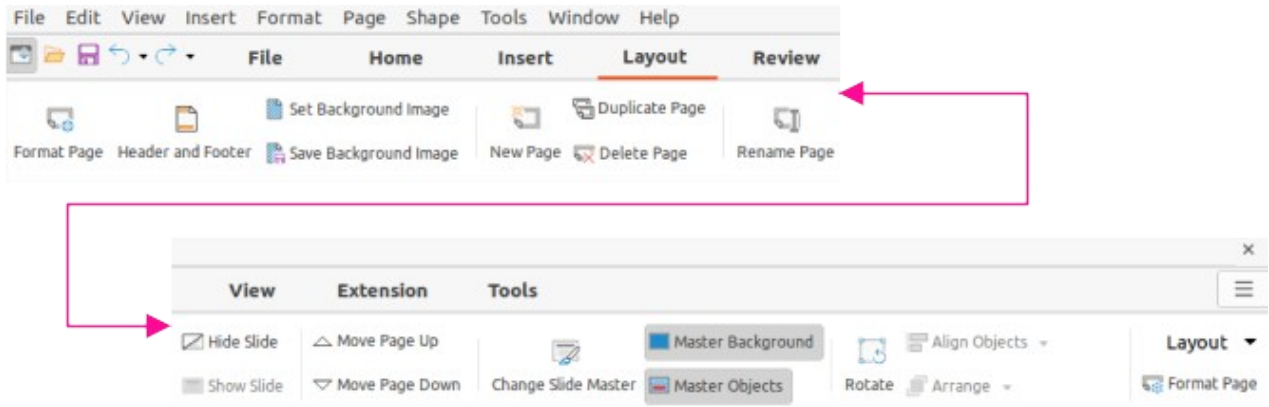

Figure 320: Tabbed user interface - Layout tab

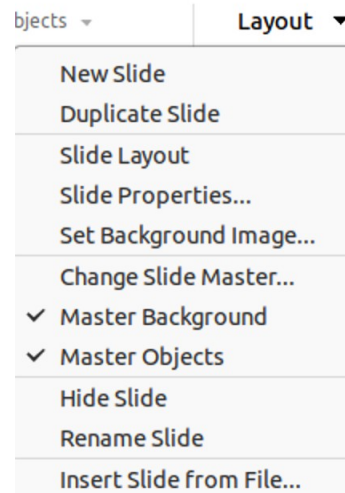

Figure 321: Layout tab menu

Review tab

The **Review** tab (Figure 322) is a fixed tab providing commands for spell checking text; inserting and deleting review comments; and redaction. The **Review** tab menu (Figure 323) provides additional text editing commands. Some of these commands appear only if **Asian** or **Complex Text Layout** are selected in **Tools > Options > Language Settings > Languages**.

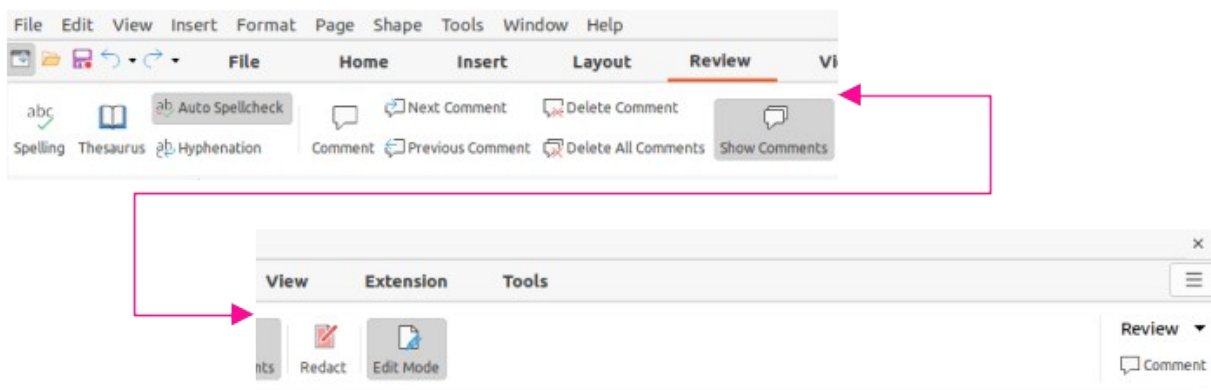

Figure 322: Tabbed user interface - Review tab

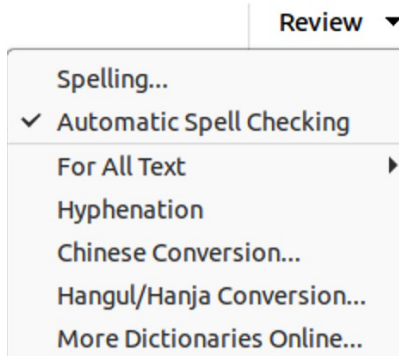

Figure 323: Review tab menu

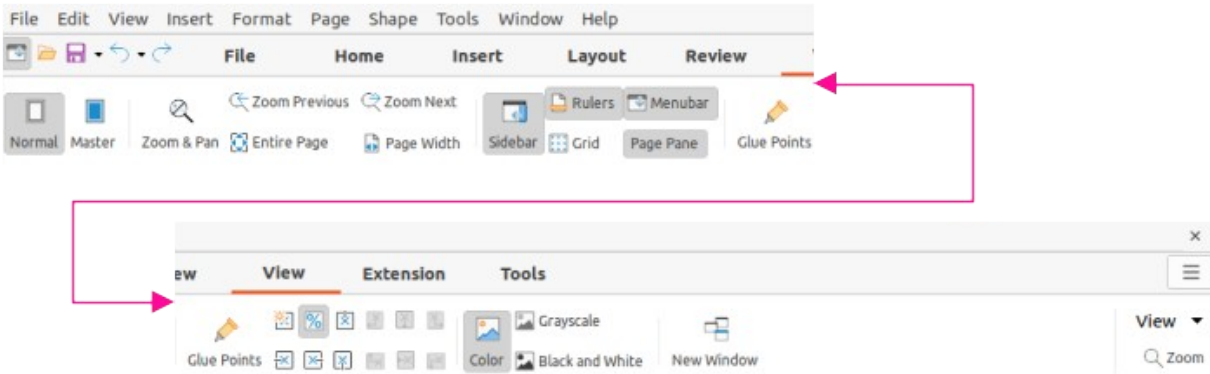

Figure 324: Tabbed user interface - View tab

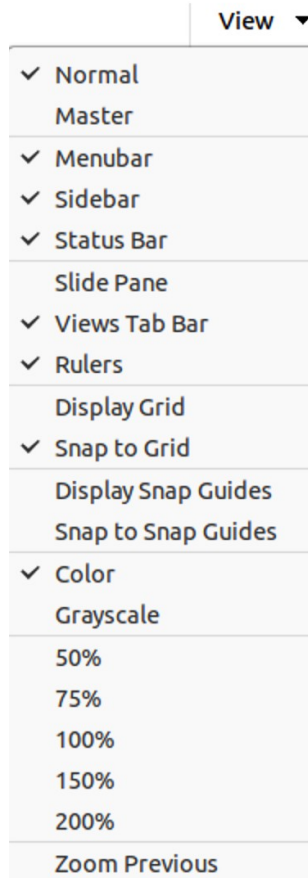

Figure 325: View tab menu

View tab

The **View** tab (Figure 324) is a fixed tab providing commands for the display of a drawing on screen. The **View** tab menu (Figure 325) provides additional commands relating to the display on a drawing on screen.

Extension tab

The **Extension** tab (Figure 326) is a fixed tab containing only the command to access the Extension Manager allowing the installation of extensions that are compatible for use in LibreOffice.

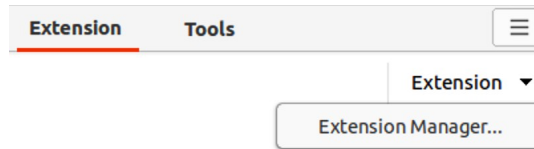

Figure 326: Tabbed user interface - Extension tab

Tools tab

The **Tools** tab (Figure 327) is a fixed tab providing several tools for macros; color replacer; media player; and form creation. The **Tools** tab menu (Figure 328) provides some of the same commands, plus extra tools for organizing macros and dialogs; image map; data sources; filter settings; extension manager; and options.

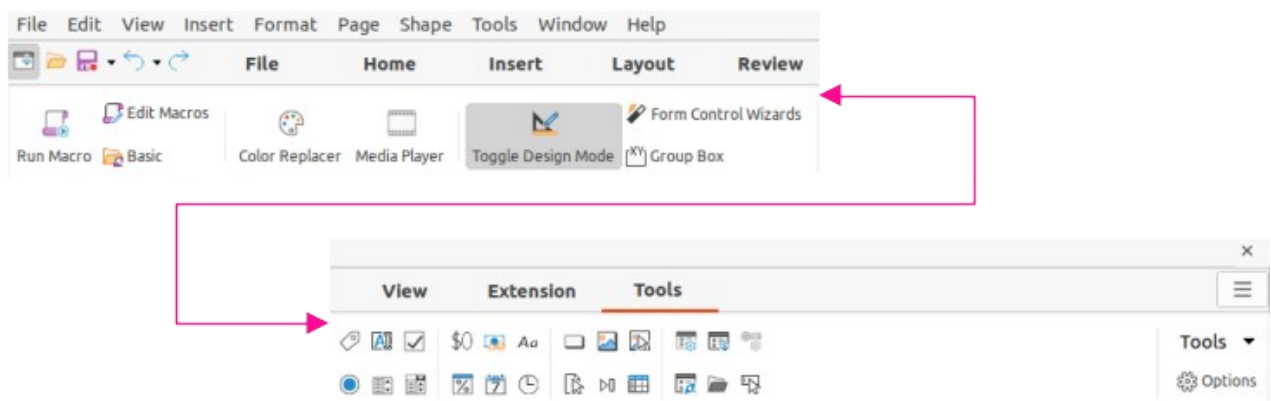

Figure 327: Tabbed user interface - Tools tab

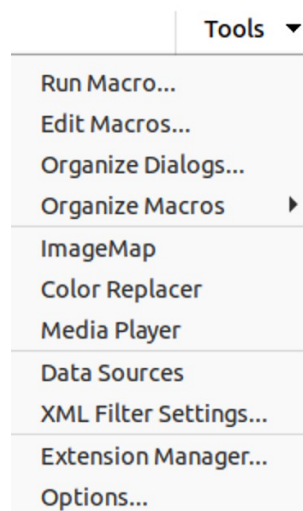

Figure 328: Tools tab menu

Additional tabs

Additional tabs appear when an object in Draw is selected and are displayed between the **View** and **Extension** tabs. The illustrations show the left and right ends of the tabs separately so they are large enough to more easily see the commands.

Draw tab

The **Draw** tab (Figure 329) is only available when a draw object is selected in a drawing. It provides commands for editing, transforming, grouping, aligning, and distributing draw objects. The **Draw** tab menu (Figure 330) provides a similar set of commands for editing, transforming and converting draw objects.

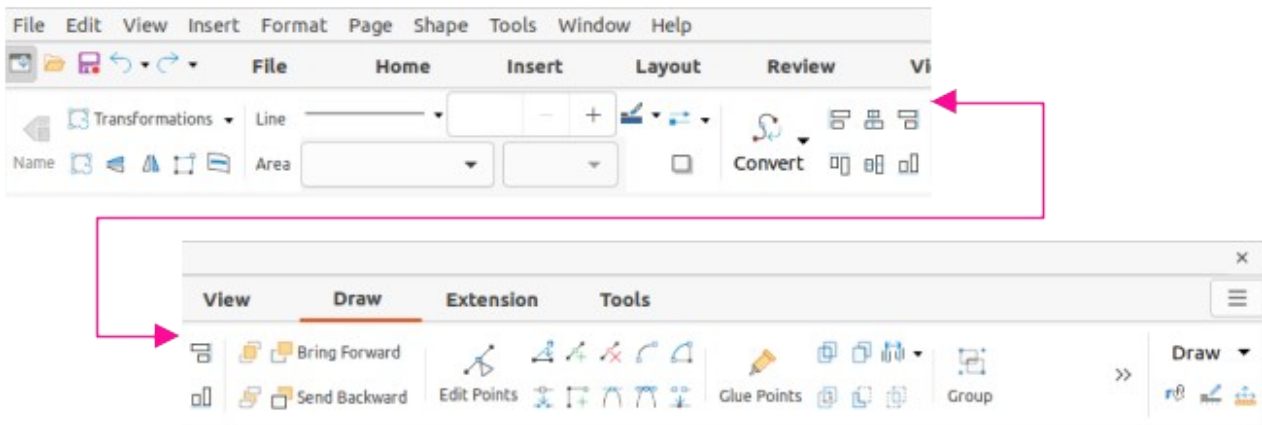

Figure 329: Tabbed user Interface - Draw tab

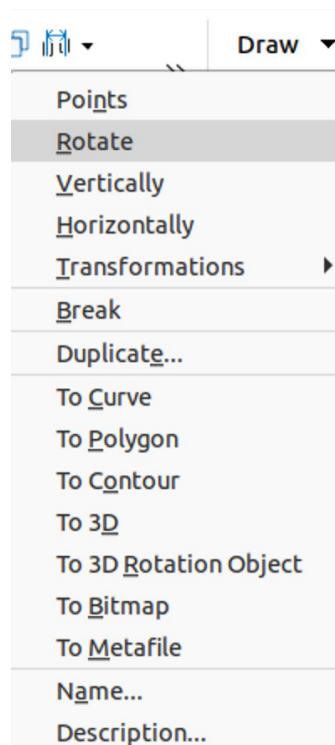

Figure 330: Draw tab menu

Image tab

The **Image** tab (Figure 331) only becomes available when an image is selected in a drawing such as a photograph, Fontwork, OLE object, or QR code. It provides commands for working with these images, including captions, cropping, borders and area styles and colors, anchors, wrapping, positioning, and filtering. The **Image** tab menu (Figure 332) provides links to dialogs for working with images.

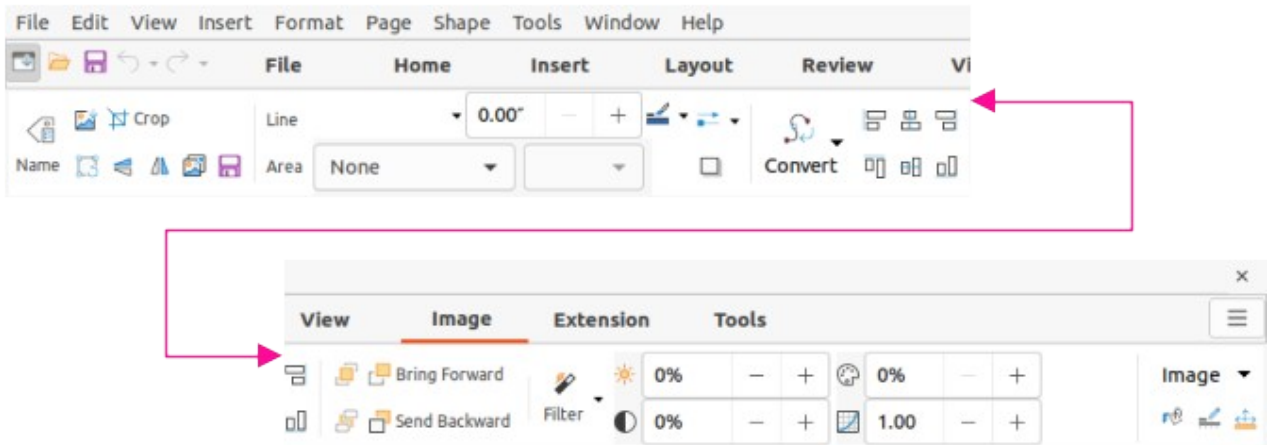

Figure 331: Tabbed user interface - Image tab

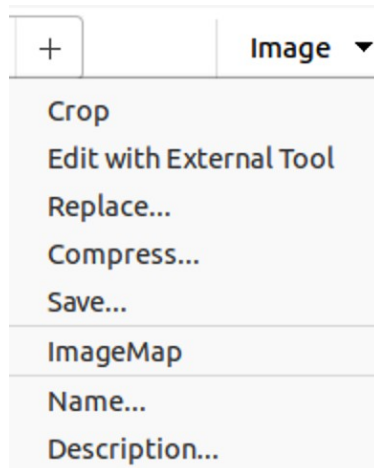

Figure 332: Image tab menu

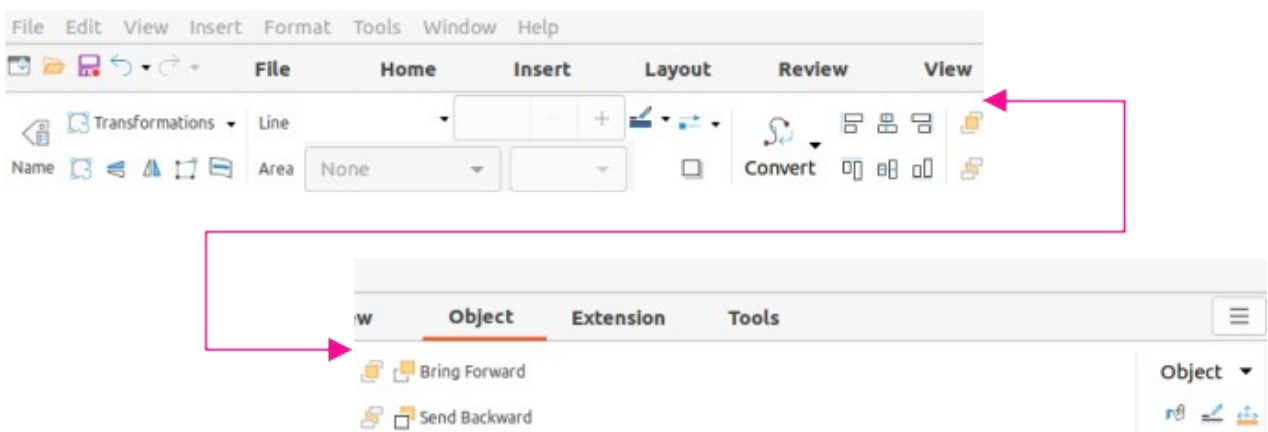

Figure 333: Tabbed user interface - Object tab

Object tab

The **Object** tab (Figure 333) only becomes available when an object, such as a chart, is selected. It provides commands to position, resize, choose colors and borders for the selected object. The **Object** tab menu (Figure 334) provides extra commands to match the type of object selected.

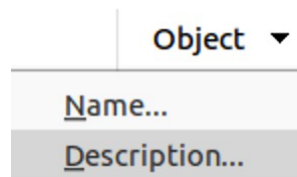

Figure 334: Object tab menu

Table tab

The **Table** tab (Figure 335) only becomes available when a table is selected in a drawing. It provides tools to format a table to the drawing requirements. The **Table** tab menu (Figure 336) includes extra commands for editing a table.

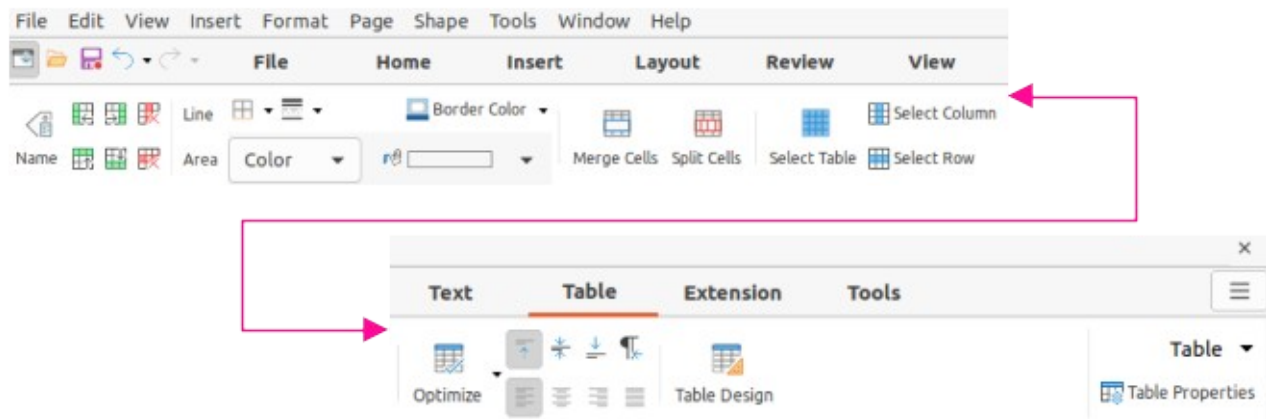

Figure 335: Tabbed user interface - Table tab

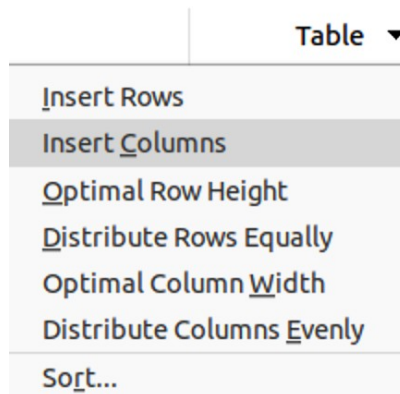

Figure 336: Table tab menu

Media tab

The **Media** tab (Figure 337) only becomes available when a media object is selected in a drawing. It provides commands for positioning and running an audio or video file. The **Media** tab menu (Figure 338) includes extra commands for editing a media object.

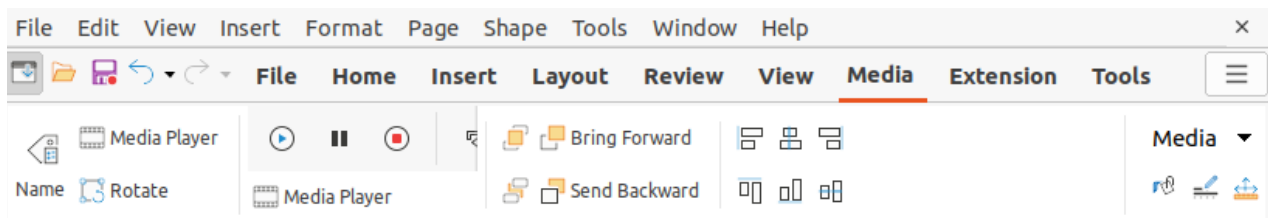

Figure 337: Tabbed user interface - Media tab

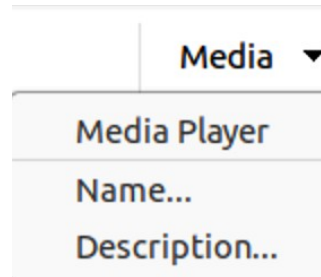

Figure 338: Media tab menu

Single Toolbar UI & Sidebar UI

When selected, the **Single Toolbar** and **Sidebar** user interfaces only show the Menu bar with no toolbars. However, toolbars can be added to either of these user interfaces by going to **View > Toolbars** on the Menu bar and selecting the required toolbar from the options available. For more information on toolbars, see Appendix B, Toolbars in this guide and the *Getting Started Guide*.

Tabbed Compact UI

The **Tabbed Compact** user interface has the same tabs as the **Tabbed** user interface, but the commands on each tab are arranged as a single row of tools. Some of these tools have drop-down menus with extra options. Figure 339 shows an example of the **File** tab in the **Tabbed Compact** user interface.

The tab menu on the right of the **Tabbed Compact** user interface provides the same options as the tab menus in the **Tabbed** user interface, see “Tabbed UI” on page 287 for more information.

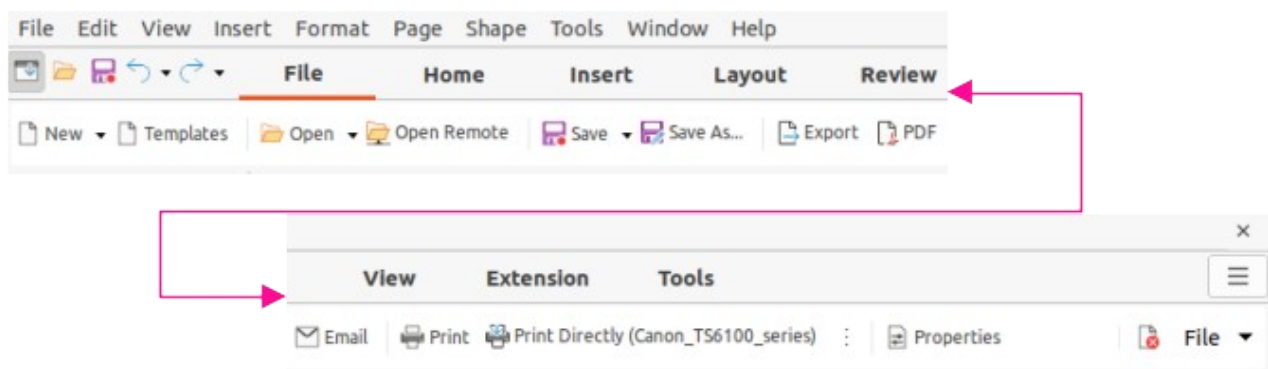

Figure 339: Tabbed Compact user interface - File tab

Groupedbar Compact UI

The **Groupedbar Compact** user interface (Figure 340), with a Draw object selected, is divided into groups that contain commands organized as sets of tools and menus. Clicking on the double chevron >> displays more tools for editing an object.

The **Groupedbar** menu (Figure 341) on the right-hand end of this interface provides extra commands for working with LibreOffice Draw, including convenient ways to change the user interface and access toolbars.

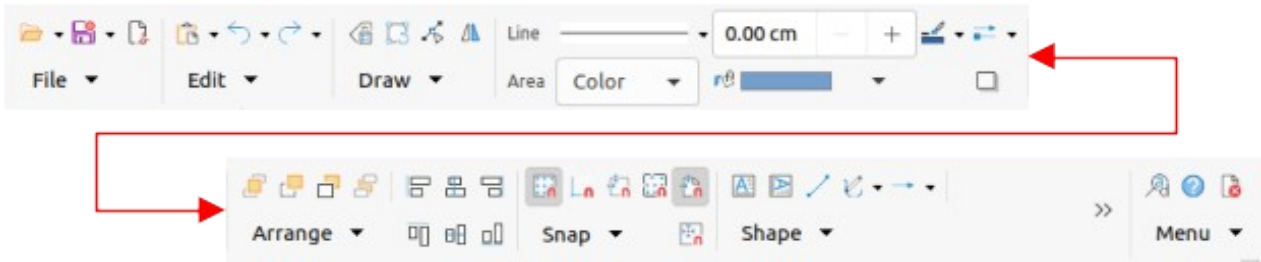

Figure 340: Groupedbar user interface with Draw object selected

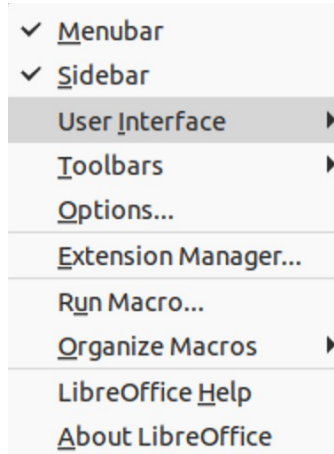

Figure 341: Groupedbar menu

Contextual Single UI

The **Contextual Single** user interface displays a single toolbar to suit the type of object that has been selected. Figure 342 shows an example of **Contextual Single** user interface when a draw object is selected. Clicking on the double chevron >> displays more tools for editing an object.

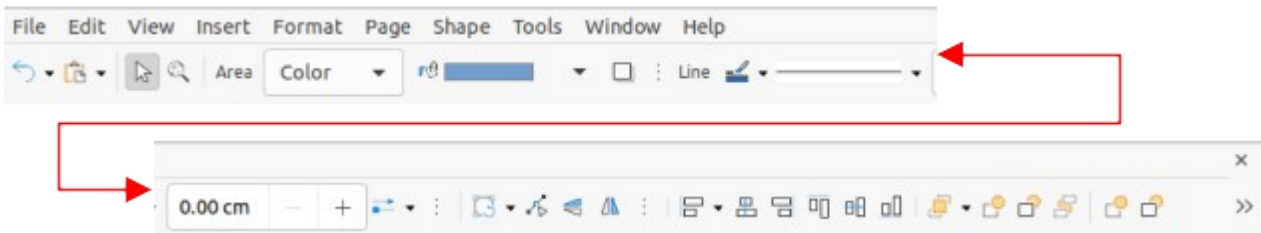

Figure 342: Contextual Single user interface with Draw object selected



LibreOffice
Community



Draw Guide 7.2

Appendix A, Keyboard Shortcuts

Introduction

LibreOffice can be used without requiring a pointing device, such as a mouse or trackball, by using the keyboard shortcuts that are available in Draw. Tasks as varied and complex as docking and un-docking toolbars and windows, or changing the size or position of objects can all be accomplished with using keyboard shortcuts. Although LibreOffice has an extensive set of keyboard shortcuts, each LibreOffice module has keyboard shortcuts that are specific to that module.

For help with LibreOffice keyboard shortcuts, or using LibreOffice with a keyboard only, search the LibreOffice Help using the “shortcut” or “accessibility” keywords.

In addition to using keyboard shortcuts that are listed in this appendix, keyboard shortcuts can also be defined. Assign keyboard shortcuts to standard Impress functions or macros and save them for use with Draw only, or with the other modules in LibreOffice. To customize keyboard shortcuts, see the *Getting Started Guide* for more information.



Note

Some keyboard shortcuts are not available for computers using macOS and are indicated in the following tables by a blank cell.

Draw function key and keyboard shortcuts

Draw function keys

Windows Linux	macOS	Effect
<i>F1</i>	<i>F1</i>	Opens LibreOffice Draw help.
<i>F2</i>	<i>F2</i>	Switches to text edit mode and opens the Text Formatting toolbar.
<i>F3</i>	<i>F3</i>	Enters a group of objects for editing.
<i>Shift + F3</i>	<i>Shift + F3</i>	Opens the Duplicate dialog of a selected object.
<i>Ctrl + F3</i>	⌘ + <i>F3</i>	Exits a group of objects.
<i>F4</i>	<i>F4</i>	Opens the Position and Size dialog of a selected object.
<i>F5</i>	<i>F5</i>	Opens the Navigator.
<i>F6</i>	<i>F6</i>	Forward navigation of the emphasis within the on screen elements.
<i>Shift + F6</i>	<i>Shift + F6</i>	Backward navigation of the emphasis within the on screen elements.
<i>F7</i>	<i>F7</i>	Starts the spelling checker. Only available in text editing mode.
<i>Shift + F7</i>	<i>Shift + F7</i>	Switches on or off the automatic spell checking. Only available in text editing mode.
<i>Ctrl + F7</i>	⌘ + <i>F7</i>	Opens the Thesaurus dialog for the language being used. Only available in text editing mode.
<i>F8</i>	<i>F8</i>	Opens the Edit Points toolbar.

Windows Linux	macOS	Effect
<i>Ctrl + Shift + F8</i>	<i>⌘ + Shift + F8</i>	Fits text to frame of a selected object.
<i>Shift + F10</i>	<i>Shift + F10</i>	Opens the context menu of a selected object.
<i>F11</i>	<i>⌘ + T</i>	Opens the Styles deck on the Sidebar.

Draw keyboard shortcuts

Windows Linux	macOS	Effect
<i>Plus (+)</i>		Zooms in.
<i>Minus (-)</i>		Zooms out.
<i>Times (×) on number pad</i>		Fits the drawing to fill the Workspace view.
<i>Divide (÷) on number pad</i>		Zooms in on the selected object.
<i>Ctrl + Shift + G</i>	<i>⌘ + Shift + G</i>	Groups selected objects.
<i>Shift + Ctrl + Alt + G</i>	<i>⌘ + Shift + Option + G</i>	Ungroups selected group.
<i>Ctrl + click</i>	<i>⌘ + click</i>	Enters a group to edit individual objects in the group. Click outside the group to return to normal view.
<i>Ctrl + Shift + K</i>	<i>⌘ + Shift + K</i>	Combines selected objects.
<i>Ctrl + Shift + Alt + K</i>	<i>⌘ + Shift + Option + K</i>	Splits a selected object that has been combined from a group of two or more objects.
<i>Ctrl + +</i>	<i>⌘ + +</i>	Brings current selection forward.
<i>Ctrl + Shift + +</i>	<i>⌘ + Shift + +</i>	Brings current selection to the front.
<i>Ctrl + -</i>	<i>⌘ + -</i>	Sends current selection backward.
<i>Ctrl + Shift + -</i>	<i>⌘ + Shift + -</i>	Sends current selection to the back.
<i>Page Up</i>		Switches to previous page. No function on the first page.
<i>Page Down</i>		Switches to next page. No function on the last page.
<i>Ctrl+Page Up</i>		Switches to previous layer.
<i>Ctrl+Page Down</i>		Switches to next layer.
<i>Arrow</i>	<i>Arrow</i>	Moves a selected object in the direction of the arrow.
<i>Ctrl+Arrow</i>	<i>Ctrl+Arrow</i>	Moves the page view in the direction of the arrow.
<i>Left Arrow</i>	<i>Left Arrow</i>	With Pages Pane selected, switches to the previous page in a drawing. No function on the first page.
<i>Right Arrow</i>	<i>Right Arrow</i>	With Pages Pane selected, switches to the next page in a drawing. No function on the last page.

Windows Linux	macOS	Effect
<i>Shift</i>	<i>Shift</i>	When selecting objects, adds or removes object to or from a selection of objects.
<i>Shift</i>	<i>Shift</i>	Hold down <i>Shift</i> then click and drag a selection handle when resizing an object to maintain the proportions of the object.
<i>Shift</i>	<i>Shift</i>	Hold down the <i>Shift</i> key while moving a selected object to constrain the movement in multiples of 45 degrees.
<i>Shift</i>	<i>Shift</i>	Hold down the <i>Shift</i> key before selecting several adjacent objects or characters. Click at the start of a selection, move to the end of the selection.
<i>Ctrl</i>	⌘	Hold down the <i>Ctrl</i> (⌘) key, then click and drag a selected object to create a copy of the object. Note that this shortcut works only when the Copy when moving option in LibreOffice > Preferences > LibreOffice Draw > General is enabled (this option is enabled by default).
<i>Alt</i>	<i>Option</i>	Hold down the <i>Alt</i> (<i>Option</i>) key and draw or resize an object from the centre of the object.
<i>Alt</i>	<i>Option</i>	Hold down the <i>Alt</i> (<i>Option</i>) key when selecting an object that is behind the currently selected object.
<i>Alt+ Shift</i>	<i>Option + Shift</i>	Hold down the <i>Alt</i> (<i>Option</i>) + <i>Shift</i> keys when selecting an object that is in front of the currently selected object.
<i>Tab</i>	<i>Tab</i>	Selects objects in the order in which they were created.
<i>Shift + Tab</i>	<i>Shift + Tab</i>	Selects objects in the reverse order in which they were created.
<i>Esc</i>	<i>Esc</i>	Exits current mode.
<i>Enter</i>	<i>Enter</i>	Enters text mode if a text object in the drawing is selected.
<i>Ctrl + Enter</i>	⌘ + <i>Enter</i>	Inserts a new page after the selected page in a drawing.
<i>Home/End</i>		Selects the first/last page in a drawing.

Editing text keyboard shortcuts

Windows Linux	macOS	Effect
<i>Ctrl + -</i>	⌘ + -	Inserts a custom hyphen (soft hyphen) in text at the cursor position.
<i>Ctrl + Shift + -</i>	⌘ + <i>Shift</i> + -	Inserts a non-breaking hyphen (hard hyphen) in text at the cursor position.
<i>Ctrl + Shift + Space</i>	⌘ + <i>Shift</i> + <i>Space</i>	Inserts a non-breaking space, which is not used for hyphenation and is not expanded if the text is justified.
<i>Shift + Enter</i>	<i>Shift</i> + <i>Enter</i>	Inserts a line break without paragraph change.

Windows Linux	macOS	Effect
<i>Left arrow</i>	<i>Left arrow</i>	Moves the cursor one character to the left.
<i>Shift + Left arrow</i>	<i>Shift + Left arrow</i>	Moves the cursor one character to the left and selects the character.
<i>Ctrl + Left arrow</i>	<i>Option + Left arrow</i>	Moves the cursor to the beginning of the previous word.
<i>Ctrl + Shift + Left arrow</i>	<i>Option + Shift + Left arrow</i>	Moves the cursor to the left and selects the word on the left.
<i>Right arrow</i>	<i>Right arrow</i>	Moves the cursor one character to the right.
<i>Shift + Right arrow</i>	<i>Shift + Right arrow</i>	Moves the cursor one character to the right and selects the character.
<i>Ctrl + Right arrow</i>	<i>Option + Right arrow</i>	Moves the cursor to the beginning of the next word.
<i>Ctrl + Shift + Right arrow</i>	<i>Option + Shift + Right arrow</i>	Moves the cursor to the right and selects the word on the right.
<i>Up arrow</i>	<i>Up arrow</i>	Moves the cursor up one line.
<i>Shift + Up arrow</i>	<i>Shift + Up arrow</i>	Moves the cursor up one line in the text and selects the lines of text.
<i>Ctrl + Up arrow</i>	<i>Option + Up arrow</i>	Moves the cursor to the beginning of the paragraph.
<i>Ctrl + Shift + Up arrow</i>	<i>Option + Shift + Up arrow</i>	Moves the cursor to the beginning of the paragraph. Selects the text in the paragraph from the cursor position to the beginning of the paragraph.
<i>Down arrow</i>	<i>Down arrow</i>	Moves the cursor down one line.
<i>Shift + Down arrow</i>	<i>Shift + Down arrow</i>	Moves the cursor down one line in the text and selects the lines of text.
<i>Ctrl + Down arrow</i>	<i>⌘ + Down arrow</i>	Moves the cursor to the end of the paragraph.
<i>Ctrl + Shift + Down arrow</i>	<i>Opt + Shift + Down arrow</i>	Moves the cursor to the end of the paragraph. Selects the text in the paragraph from the cursor position to the end of the paragraph.
<i>Home</i>		Moves the cursor to the beginning of the line.
<i>Shift + Home</i>		Moves the cursor to the beginning of the line and selects the text from the cursor position.
<i>Ctrl + Home</i>		Moves the cursor to the beginning of the text block on the slide.
<i>End</i>		Moves the cursor to the end of the line.
<i>Shift + End</i>		Moves the cursor to the end of the line and selects the text from the cursor position.
<i>Ctrl + End</i>		Moves the cursor to the end of the text block on the slide.

<i>Windows Linux</i>	<i>macOS</i>	<i>Effect</i>
<i>Ctrl + Del</i>		Deletes the text from the cursor position to the end of the word.
<i>Ctrl + Shift + Del</i>		Deletes the text from the cursor position to the end of the sentence.
<i>Ctrl + Backspace</i>	⌘ + <i>Backspace</i>	Deletes the text from the cursor position to the beginning of the word.
<i>Ctrl + Shift + Backspace</i>	⌘ + <i>Shift + Backspace</i>	Deletes the text from the cursor position to the beginning of the sentence.

Menu function key and keyboard shortcuts

The function key and keyboard shortcuts listed in the following tables are available in each menu category on the Menu bar. The tables give the menu item or sub-item, operating system validity, and the effect or purpose of the shortcut.

Note

The menus listed below are in the same order as displayed on the Menu bar from left to right.

File menu

<i>Menu item or sub-item</i>	<i>Windows Linux</i>	<i>macOS</i>	<i>Effect</i>
Open	<i>Ctrl + O</i>	⌘ + <i>O</i>	Opens the Open file browser allowing navigation to a folder and file selection.
Save	<i>Ctrl + S</i>	⌘ + <i>S</i>	Saves the open drawing.
Save As	<i>Ctrl + Shift + S</i>	⌘ + <i>Shift + S</i>	Opens the Save as file browser allowing navigation to a folder and saving the open drawing as a new file.
Print	<i>Ctrl + P</i>	⌘ + <i>P</i>	Opens the Print dialog allowing selection of how the drawing is printed.

Edit Menu

<i>Menu item or sub-item</i>	<i>Windows Linux</i>	<i>macOS</i>	<i>Effect</i>
Undo	<i>Ctrl + Z</i>	⌘ + <i>Z</i>	Undoes the previous editing action.
Redo	<i>Ctrl + Y</i>	⌘ + <i>Y</i>	Reverses the action of the last Undo command.
Cut	<i>Ctrl + X</i>	⌘ + <i>X</i>	Deletes the selected object and places it on the clipboard.
Copy	<i>Ctrl + C</i>	⌘ + <i>C</i>	Copies the selected object to the clipboard.

Menu item or sub-item	Windows Linux	macOS	Effect
Paste	<i>Ctrl + V</i>	⌘ + V	Places the object on the clipboard into the drawing.
Paste Special > Paste Special	<i>Ctrl + Shift + V</i>	⌘ + Shift + V	Pastes the contents of the clipboard at the cursor position in a format that is specified using the Paste Special dialog.
Select All	<i>Ctrl + A</i>	⌘ + A	Selects all objects in a drawing.
Points	<i>F8</i>	<i>F8</i>	Opens the Edit Points toolbar if there is an object on the drawing that uses editable points, for example a freeform line.

View menu

Menu item or sub-item	Windows Linux	macOS	Effect
Rulers	<i>Ctrl + Shift + R</i>	⌘ + Shift + R	Switches the rulers off and on in the Workspace.
Sidebar	<i>Ctrl + F5</i>		Opens or closes the Sidebar.
Styles	<i>F11</i>	⌘ + T	Opens or closes the Styles deck on the Sidebar.
Navigator	<i>F5</i>	<i>F5</i>	Opens the Navigator .

Insert menu

Menu item or sub-item	Windows Linux	macOS	Effect
Text Box	<i>F2</i>	<i>F2</i>	Switches to text edit mode and opens the Text Formatting toolbar.
Hyperlink	<i>Ctrl + K</i>	⌘ + K	Opens the Hyperlink dialog.
Comment	<i>Ctrl + Alt + C</i>	⌘ + Option + C	Inserts a new comment box onto the selected page.
Formatting Mark > Insert non-breaking space	<i>Ctrl + Shift + Space</i>	⌘ + Shift + Space	Inserts a non-breaking space at the cursor position.
Formatting Mark > Insert Narrow No-break Space	<i>Alt + Shift + Space</i>	<i>Alt + Shift + Space</i>	Inserts a narrow non-breaking space at the cursor position.
Formatting Mark > No-width Optional Break	<i>Ctrl + /</i>	⌘ + /	Inserts a narrow no-width optional break at the cursor position.

Format menu

Menu item or sub-item	Windows Linux	macOS	Effect
Text > Bold	<i>Ctrl + B</i>	⌘ + <i>B</i>	Applies Bold format to selected text.
Text > Italic	<i>Ctrl + I</i>	⌘ + <i>I</i>	Applies <i>Italic</i> format to selected text.
Text > Superscript	<i>Ctrl + Shift + P</i>	⌘ + <i>Shift + P</i>	Reduces the font size of the selected text and raises the text above the baseline.
Text > Subscript	<i>Ctrl + Shift + B</i>	⌘ + <i>Shift + B</i>	Reduces the font size of the selected text and lowers the text below the baseline.
Text > Increase Size	<i>Ctrl +]</i>	⌘ + <i>]</i>	Increases the point size of selected text.
Text > Decrease Size	<i>Ctrl + [</i>	⌘ + <i>[</i>	Decreases the point size of selected text.
Spacing > Line Spacing 1	<i>Ctrl + 1</i>	⌘ + <i>1</i>	Sets the line spacing in a paragraph to a single line.
Spacing Line Spacing 5	<i>Ctrl + 5</i>	⌘ + <i>5</i>	Sets the line spacing in a paragraph to one and half lines.
Spacing > Line Spacing 2	<i>Ctrl + 2</i>	⌘ + <i>2</i>	Sets the line spacing in a paragraph to two lines.
Align Text > Left	<i>Ctrl + L</i>	⌘ + <i>L</i>	Sets the paragraph alignment to left aligned.
Align Text > Center	<i>Ctrl + E</i>	⌘ + <i>E</i>	Sets the paragraph alignment to center aligned.
Align Text > Right	<i>Ctrl + R</i>	⌘ + <i>R</i>	Sets the paragraph alignment to right aligned.
Align Text > Justified	<i>Ctrl + J</i>	⌘ + <i>J</i>	Sets the paragraph alignment to justified.
Clear Direct Formatting	<i>Ctrl + M</i>	<i>Ctrl + M</i>	Removes direct formatting that has been applied without using styles.
Styles > Manage Styles	<i>F11</i>	⌘ + <i>T</i>	Opens or closes the Styles deck on the Sidebar.
Position and Size	<i>F4</i>	<i>F4</i>	Opens the Position and Size dialog of a selected object.

Shape menu

Menu item or sub-item	Windows Linux	macOS	Effect
Arrange > Bring to Front	<i>Ctrl + Shift + +</i>	⌘ + <i>Shift + +</i>	Moves a selected object to the front of other objects.
Arrange > Bring Forward	<i>Ctrl + +</i>	⌘ + <i>+</i>	Moves a selected object in front of the forward object.

Menu item or sub-item	Windows Linux	macOS	Effect
Arrange > Send Backward	<i>Ctrl + -</i>	<i>⌘ + -</i>	Moves a selected object behind the backward object.
Arrange > Send to Back	<i>Ctrl + Shift + -</i>	<i>⌘ + Shift + -</i>	Moves a selected object to the back of other objects.
Group > Group	<i>Ctrl + Shift + G</i>	<i>⌘ + Shift + G</i>	Groups selected objects.
Group > Ungroup	<i>Ctrl + Alt + Shift + G</i>	<i>⌘ + Option + Shift + G</i>	Ungroups selected group.
Group > Enter Group	<i>F3</i>	<i>F3</i>	Enters a group of objects for editing.
Group > Exit Group	<i>Ctrl + F3</i>	<i>⌘ + F3</i>	Exits a group of objects.
Duplicate	<i>Shift + F3</i>	<i>Shift + F3</i>	When an object is selected, opens the Duplicate dialog, which provides options for duplicating the selected object.

Tools menu

Menu item or sub-item	Windows Linux	macOS	Effect
Spelling	<i>F7</i>		Starts spelling checker. Only available in text editing mode.
Automatic Spell Checking	<i>Shift + F7</i>	<i>Shift + F7</i>	Switches on or off the automatic spell checking. Only available in text editing mode.
Thesaurus	<i>Ctrl + F7</i>	<i>⌘ + F7</i>	Opens the thesaurus dialog for the language being used. Only available in text editing mode.
Extension Manager	<i>Ctrl + Alt + E</i>	<i>⌘ + Alt + E</i>	Opens the Extension Manager dialog.
Options	<i>Alt + F12</i>		Opens the Options LibreOffice dialog.

Windows menu

Menu item or sub-item	Windows Linux	macOS	Effect
Closes Window	<i>Ctrl + W</i>	<i>⌘ + W</i>	Closes the active window. If there is only one window, closes Draw.

Help menu

Menu item or sub-item	Windows Linux	macOS	Effect
LibreOffice Help	<i>F1</i>	<i>F1</i>	Opens your browser application at the LibreOffice Help pages.

General function key and keyboard shortcuts

Opening menus and menu items

Windows Linux	macOS	Effect
<i>Alt + <?></i>		Press the <i>Alt</i> key first, then select the underlined character of the menu to be opened. The <i><?></i> is the underlined character in the menu. For example, <i>Alt+F</i> opens the File menu. With the menu open, menu items have an underlined character. To access these menu items directly, press the underlined character key. Where two menu items have the same underlined character, press the character key again to move to the next item. If an item in a menu has no underlined character, click on the menu item directly.
<i>Esc</i>	<i>Esc</i>	Closes an open menu.
<i>F6</i>	<i>F6</i>	Repeatedly pressing <i>F6</i> cycles the focus through the following objects: Menu bar (Windows and Linux operating systems only) Each toolbar from top to bottom and from left to right Each free window from left to right Drawing
<i>Shift + F6</i>	<i>Shift + F6</i>	Repeatedly pressing <i>Shift+F6</i> cycles the focus in the opposite direction.
<i>Ctrl + F6</i>	<i>Ctrl + F6</i>	Cycles the focus back to the drawing.
<i>F10</i>		Switches the access on or off for the Menu bar.

Accessing Menu bar commands

- Press *F6* to select the first item on the Menu bar (the File menu).
- Press the right arrow to select the next menu to the right.
- Press the left arrow to select the previous menu to the left.
- Press the *Home* and *End* keys to select the first or last item on the Menu bar.
- Press the down arrow to open a selected menu. An additional press on the down arrow or up arrow moves the selection through the menu commands.
- Press the right arrow to open any submenus on the selected menu. Submenus are indicated by a triangle ► next to the menu item.
- Press *Enter* to execute the selected menu command.

Accessing toolbar commands

- Press F6 repeatedly until the first tool on a toolbar is selected.
- Use the right and left arrows to select a tool on a horizontal toolbar, or the up and down arrows to select a tool on a vertical toolbar.
- Press the *Home* key to select the first tool on a toolbar, or the *End* key to select the last tool on a toolbar.
- Press *Enter* to activate the selected tool.
- Press the right arrow to open any sub-toolbar on the selected toolbar. Sub-toolbars are indicated by a triangle ▼ next to the tool.
- Keep pressing the right arrow to select a tool on a sub-toolbar.
- Press *Ctrl+Enter* to insert the selected draw object. The draw object is placed in the center of the drawing, with a predefined size.

Controlling dialogs

When any dialog is opened, one element (for example a button or option field) indicates it has focus by highlighting, a check mark, or a dotted box around the field or button name.

Windows Linux	Effect
<i>Enter</i>	Activates the selected option. Where no option is selected, <i>Enter</i> is the equivalent to clicking on OK .
<i>Esc</i>	Closes a dialog without saving any changes made while it was open, the equivalent to selecting Cancel .
<i>Up or down arrow keys</i>	Moves focus up and down a list. Increases or decreases the value of a variable. Moves focus vertically within a section of dialog.
<i>Left or right arrow keys</i>	Moves focus horizontally within a section of a dialog.
<i>Tab</i>	Advances focus to the next section or element of a dialog.
<i>Shift + Tab</i>	Moves the focus to the previous section or element in a dialog.
<i>Alt + Down Arrow</i>	Shows the options available in a drop-down list.
<i>Spacebar</i>	Checks or selects an empty checkbox. Clears or deselects a checked checkbox.

Toolbar function key and keyboard shortcuts

Draw provides several toolbars for the creation and editing of drawings. Some tools on the Draw toolbars can be activated using a function key or keyboard shortcut.

Note

The Draw toolbars are listed in the same order displayed in the context menu that is opened by going to **View > Toolbars** on the Menu bar.

Drawing

Tool name	Windows Linux macOS	Effect
Insert Text Box	<i>F2</i>	Switches to text edit mode and opens the Text Formatting toolbar.
Edit Points	<i>F8</i>	Opens the Edit Points toolbar if there is an object on the drawing that uses editable points, for example a freeform line.

Find

Tool name	Windows Linux	macOS	Effect
Find and Replace	<i>Ctrl + H</i>	<i>⌘ + Option + H</i>	Finds and replaces all instances of text in a drawing.

Form Design

Tool name	Windows Linux	macOS	Effect
Bring to Front	<i>Ctrl + Shift + +</i>	<i>⌘ + Shift + +</i>	Moves a selected object to the front of other objects.
Send to Back	<i>Ctrl + Shift + -</i>	<i>⌘ + Shift + -</i>	Moves a selected object to the back of other objects.
Group	<i>Ctrl + Shift + G</i>	<i>⌘ + Shift + G</i>	Groups selected objects.
Ungroup	<i>Ctrl + Alt + Shift + G</i>	<i>⌘ + Option + Shift + G</i>	Ungroups selected group.
Enter Group	<i>F3</i>	<i>F3</i>	Enters a group of objects for editing.
Exit Group	<i>Ctrl + F3</i>	<i>⌘ + F3</i>	Exits a group of objects.

Image

Tool name	Windows Linux	macOS	Effect
Position and Size	<i>F4</i>	<i>F4</i>	Opens the Position and Size dialog of a selected object.
Bring to Front	<i>Ctrl + Shift + +</i>	<i>⌘ + Shift + +</i>	Moves a selected object to the front of other objects.
Bring Forward	<i>Ctrl + +</i>	<i>⌘ + +</i>	Moves a selected object in front of the forward object.
Send Backward	<i>Ctrl + -</i>	<i>⌘ + -</i>	Moves a selected object behind the backward object.
Send to Back	<i>Ctrl + Shift + -</i>	<i>⌘ + Shift + -</i>	Moves a selected object to the back of other objects.

Line and Filling

<i>Tool name</i>	<i>Windows Linux</i>	<i>macOS</i>	<i>Effect</i>
Position and Size	<i>F4</i>	<i>F4</i>	Opens the Position and Size dialog of a selected object.
Bring to Front	<i>Ctrl + Shift + +</i>	<i>⌘ + Shift + +</i>	Moves a selected object to the front of other objects.
Bring Forward	<i>Ctrl + +</i>	<i>⌘ + +</i>	Moves a selected object in front of the forward object.
Send Backward	<i>Ctrl + -</i>	<i>⌘ + -</i>	Moves a selected object behind the backward object.
Send to Back	<i>Ctrl + Shift + -</i>	<i>⌘ + Shift + -</i>	Moves a selected object to the back of other objects.
Styles	<i>F11</i>	<i>⌘ + T</i>	Opens the Styles deck on the Sidebar.

Standard

<i>Tool name</i>	<i>Windows Linux</i>	<i>macOS</i>	<i>Effect</i>
New	<i>Ctrl + N</i>	<i>⌘ + N</i>	Opens a new drawing.
Templates	<i>Ctrl + Shift + N</i>	<i>⌘ + Shift + N</i>	Opens the Templates dialog to create a new drawing using a template.
Open	<i>Ctrl + O</i>	<i>⌘ + O</i>	Opens the Open file browser to allow navigation to a folder and selection of a drawing.
Save	<i>Ctrl + S</i>	<i>⌘ + S</i>	Saves the open document.
Save As	<i>Ctrl + Shift + S</i>	<i>⌘ + Shift + S</i>	Opens the Save as file browser to save the open drawing as a new drawing.
Edit Mode	<i>Ctrl + Shift + M</i>	<i>⌘ + Shift + M</i>	Switches on edit mode when a drawing is in read only mode.
Print	<i>Ctrl + P</i>	<i>⌘ + P</i>	Opens the Print dialog to select how to print the drawing.
Cut	<i>Ctrl + X</i>	<i>⌘ + X</i>	Deletes the selected object and places it on the clipboard.
Copy	<i>Ctrl + C</i>	<i>⌘ + C</i>	Copies the selected object to the clipboard.
Paste	<i>Ctrl + V</i>	<i>⌘ + V</i>	Places the object on the clipboard into the document.
Clear	<i>Ctrl + M</i>	<i>Ctrl + M</i>	Removes direct formatting that has been applied without using styles.
Undo	<i>Ctrl + Z</i>	<i>⌘ + Z</i>	Undoes the previous editing action.
Redo	<i>Ctrl + Y</i>	<i>⌘ + Y</i>	Reverses the action of the last Undo command.

Tool name	Windows Linux	macOS	Effect
Spelling	<i>F7</i>	<i>F7</i>	Starts the spelling checker. Only available in text editing mode.
Auto Spellcheck	<i>Shift + F7</i>	<i>Shift + F7</i>	Switches on or off the automatic spell checking. Only available in text editing mode.
Text Box	<i>F2</i>	<i>F2</i>	Switches to text edit mode and opens the Text Formatting toolbar.
Insert Hyperlink	<i>Ctrl + K</i>	<i>⌘ + K</i>	Opens the Hyperlink dialog.
Position and Size	<i>F4</i>	<i>F4</i>	Opens the Position and Size dialog of a selected object.
Edit Points	<i>F8</i>	<i>F8</i>	Opens the Edit Points toolbar if there is an object on the drawing that uses editable points, for example a freeform line.

Standard (Viewing Mode)

Tool name	Windows Linux	macOS	Effect
Save As	<i>Ctrl + Shift + S</i>	<i>⌘ + Shift + S</i>	Opens the Save as file browser so you can save the open document as a new document.
Edit Mode	<i>Ctrl + Shift + M</i>	<i>⌘ + Shift + M</i>	Switches on edit mode when a document is in read only mode.
Print	<i>Ctrl + P</i>	<i>⌘ + P</i>	Opens the Print dialog so that you can select how you want to print the document.
Copy	<i>Ctrl + C</i>	<i>⌘ + C</i>	Copies the selected object to the clipboard.
Find and Replace	<i>Ctrl + H</i>	<i>⌘ + Option + F</i>	Opens the Find and Replace dialog.

Text Formatting

Tool name	Windows Linux	macOS	Effect
Increase	<i>Ctrl +]</i>	<i>⌘ +]</i>	Increases the point size of selected text.
Decrease	<i>Ctrl + [</i>	<i>⌘ + [</i>	Decreases the point size of selected text.
Bold	<i>Ctrl + B</i>	<i>⌘ + B</i>	Applies Bold format to selected text.
Italic	<i>Ctrl + I</i>	<i>⌘ + I</i>	Applies <i>Italic</i> format to selected text.
Superscript	<i>Ctrl + Shift + P</i>	<i>Ctrl + Shift + P</i>	Reduces the font size of the selected text and raises the text above the baseline.

Tool name	Windows Linux	macOS	Effect
Subscript	<i>Ctrl + Shift + B</i>	<i>Ctrl + Shift + B</i>	Reduces the font size of the selected text and lowers the text below the baseline.
Clear	<i>Ctrl + M</i>	<i>Ctrl + M</i>	Removes direct formatting that has been applied without using styles.
Left	<i>Ctrl + L</i>	⌘ + <i>L</i>	Sets the paragraph alignment to left aligned.
Center	<i>Ctrl + E</i>	⌘ + <i>E</i>	Sets the paragraph alignment to center aligned.
Right	<i>Ctrl + R</i>	⌘ + <i>R</i>	Sets the paragraph alignment to right aligned.
Justified	<i>Ctrl + J</i>	⌘ + <i>J</i>	Sets the paragraph alignment to justified.
Select All	<i>Ctrl + A</i>	⌘ + <i>A</i>	Selects all the text in a text box.



LibreOffice
Community



Draw Guide 7.2

Appendix B, Toolbars

Introduction

Draw provides several toolbars to help in creating drawings. Each toolbar has a default set of tools and the option to add additional tools.

Note

The icons displayed in the Draw toolbars illustrated in this appendix may differ from what is displayed on a computer screen. Toolbar icons depend on the computer operating system being used and how LibreOffice has been set up. For more information on customizing LibreOffice and the toolbars, see the *Getting Started Guide*.

Using toolbars

Displaying toolbars

To display a toolbar and make it active, go to **View > Toolbars** on the Menu bar. A submenu opens with a list of available toolbars for Draw. Click on a toolbar name to display it and make it active. Active toolbars are indicated by highlighting or a check mark next to the name.

Impress toolbars available

- | | |
|-------------------------|------------------------------|
| 1) 3D-Objects | 16) Legacy Circles and Ovals |
| 2) 3D-Settings | 17) Legacy Rectangles |
| 3) Align Objects | 18) Line and Filling |
| 4) Comments | 19) Master View |
| 5) Distribute Selection | 20) Media Playback |
| 6) Drawing | 21) Options |
| 7) Edit Points | 22) Redaction |
| 8) Find | 23) Standard |
| 9) Fontwork | 24) Standard (Single Mode) |
| 10) Form Controls | 25) Standard (Viewing Mode) |
| 11) Form Design | 26) Table |
| 12) Form Navigation | 27) Text Formatting |
| 13) Glue Points | 28) Transformations |
| 14) Image | 29) Zoom |
| 15) Insert | |

Note

Some toolbars, although selected in **View > Toolbars** on the Menu bar, will not display until an object of the correct type is selected in the drawing. For example, the Image toolbar only displays when an image is selected.

Closing toolbars

To close a toolbar, use one of the following methods:

- Go to **View > Toolbars** on the Menu bar and deselect the toolbar.
- Right-click on a tool on a toolbar and select **Close Toolbar** from the context menu.
- Click on the **X** in the right corner of the title bar of a floating toolbar.



Figure 343: Toolbar handles

Moving toolbars

Docked toolbars

By default, some toolbars are docked into position in the Draw main window. For example, the Standard toolbar is docked at the top of the main window. Docked toolbars can be undocked and moved to a new docked position on the main window or left as a floating toolbar. Before moving a toolbar, the toolbar must be unlocked.

- 1) Move the mouse cursor over the small vertical handle at the left end of the toolbar as shown in Figure 343. The mouse cursor changes to a moving cursor for the computer system and setup.
- 2) Click and hold down the mouse button and drag the toolbar to a new location. This can be a new docked position or a floating toolbar. A hashed border appears around the toolbar indicating the toolbar position as it is dragged.
- 3) Release the mouse button when the required position is reached.

✓ Note

If the small vertical bar is not visible at the left end of a docked toolbar, then the toolbar is locked into position. A docked toolbar must be unlocked before it can be moved to a new position in the Draw main window.

Floating toolbars

To move a floating toolbar, click on its title bar and drag it to a new floating location. Release the mouse button when the toolbar is in the required position. A floating toolbar does not have to be positioned on the Draw main window for it to function.

Floating sub-toolbars

Some tools on a toolbar have a triangle ▼ to the right of the tool indicating that more tools are available on a sub-toolbar, for example **Basic Shapes** on the Drawing toolbar. Sub-toolbars can be turned into floating toolbars and moved into a new position as follows:

- 1) Move the mouse cursor over the horizontal handle at the top of the toolbar, as shown in Figure 344. The cursor changes to the moving cursor used for the computer system and setup.
- 2) Click and hold down the mouse button and drag the toolbar to a new location to create a floating sub-toolbar.
- 3) Release the mouse button when the required position is reached.
- 4) To close the floating sub-toolbar, right-click on the triangle ▼ in the sub-toolbar title bar and select **Close Toolbar** from the context menu.

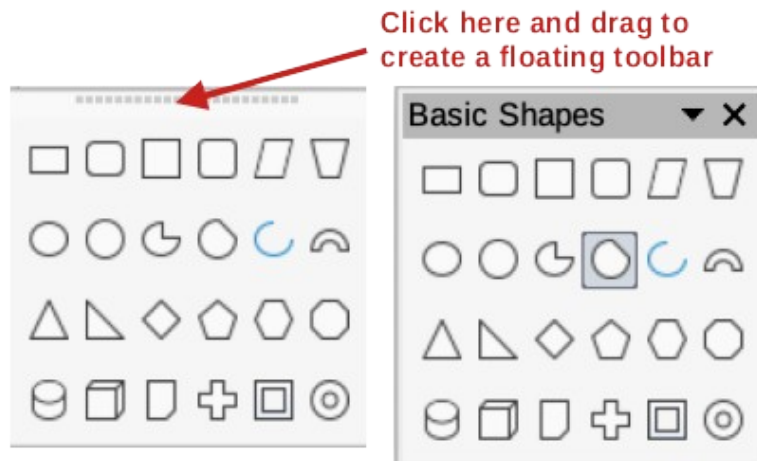

Figure 344: Creating floating sub-toolbar

Docking a floating toolbar

To dock a floating toolbar, use one of the following methods:

- Click on the title bar and drag it to the top, bottom, left side, or right side of the main window. When the toolbar reaches a docking position, a hashed border appears at the docked position. Release the mouse button and the toolbar is docked.
- Right-click on the toolbar and select **Dock Toolbar** from the context menu. The toolbar moves into a docked position. If the position is not suitable, move the toolbar to a new docked position.
- To dock all floating toolbars that are active, right-click on the toolbar and select **Dock All Toolbars** from the context menu.

Locking toolbars

Docked toolbars

When a toolbar has been docked into position on the Draw main window, the toolbar can also be locked into position preventing the toolbar from becoming a floating toolbar.

- To lock a toolbar into a docked position, right-click in a blank area on the toolbar and select **Lock Toolbar Position** in the context menu. A check mark appears against this option indicating the toolbar is now locked.
- To unlock a toolbar, right-click in a blank area on the toolbar and click on **Lock Toolbar Position** in the context menu. The check mark next to this option disappears indicating the toolbar is now unlocked. A small vertical or horizontal bar appears at the left end or top of the toolbar indicating that the toolbar is unlocked. This bar is also used to move the toolbar.

✓ Note

Some toolbars cannot be docked or locked into position. This is indicated by the options **Dock Toolbar** and/or **Lock Toolbar Position** being grayed out, making the options unavailable.

Locking sub-toolbars

To prevent sub-toolbars from becoming floating sub-toolbars, sub-toolbars have to be locked as follows:

- 1) Save any drawing that is open in Draw.

- 2) Go to **View > Toolbars** on the Menu bar and select **Lock Toolbars** from the context menu.
- 3) Select **Restart Now** in the Restart LibreOffice dialog that opens to activate the **Lock Toolbars** option.
- 4) To unlock sub-toolbars so they can become floating sub-toolbars, repeat Steps 1 thru 3. The **Lock Toolbars** option is an on/off switch.

Note

Using **Lock Toolbars** option affects all sub-toolbars available in LibreOffice modules.

Editing toolbars

When LibreOffice is installed on a computer, it includes a set of toolbars suitable for each LibreOffice component. Each toolbar has a default set of visible tools. You can add tools, delete tools, and customize toolbars.

Adding tools

- 1) Right-click in a blank area on a toolbar, or click on the triangle ▼ on the right of the toolbar title bar.
- 2) Select **Visible Buttons** from the context menu to display a list of available tools.
- 3) Click on the tool required and the tool appears in the toolbar. The list of available tools closes automatically. A highlight or check mark next to the tool indicates that the tool is already installed on the toolbar.

Note

When adding tools using **Visible Buttons**, the tool is added to the toolbar at the same position as the tool appears in the **Visible Buttons** list. That is, the top tool in **Visible Buttons** appears at the left end of the toolbar and the bottom tool appears at the right end of the toolbar. Tool positions cannot be changed using **Visible Buttons**.

Deleting tools

- 1) Right-click in a blank area on a toolbar, or click on the triangle ▼ on the right of the toolbar title bar.
- 2) Select **Visible Buttons** from the context menu to display a list of available tools.
- 3) Click on the tool no longer required and the tool is removed from the toolbar. The highlight or check mark next to the tool is also removed. The list of available tools closes automatically.

Customizing toolbars

Extra tools and commands that are not available in **Visible Buttons** can be added to a toolbar using customization. Customization also allows the creation of new toolbars if a specific set of tools are required for a specific task. For information on customizing toolbars, see the *Getting Started Guide*.

Toolbars

✓ Note

The tools installed on a toolbar are normally indicated in **Visible Buttons** either by the tool icon being highlighted or by a check mark. However, this install indication depends on computer setup and computer operating system being used.

✓ Note

On some toolbars, the icons have a small downward pointing triangle ▼ to the right of an icon. Click on this triangle to open further options that are available for use.

✓ Note

Some of the tools in the toolbars also have the option of using a keyboard shortcut instead of clicking on the tool. For a full list of keyboard shortcuts that are available in Draw, see Appendix A, Keyboard Shortcuts.

3D-Objects

The 3D-Objects toolbar (Figure 345) provides tools to create 3D objects in a slide. It is activated by going to **View > Toolbars > 3D-Objects** on the Menu bar. Alternatively, click on the triangle ▼ next to the **3D-Objects** icon displayed on the Drawing toolbar to open a submenu giving access to the available 3D objects.

Available tools from left to right

- | | |
|-------------|----------------|
| 1) Cube | 5) Pyramid |
| 2) Sphere | 6) Torus |
| 3) Cylinder | 7) Shell |
| 4) Cone | 8) Half Sphere |



Figure 345: 3D-Objects toolbar

3D-Settings

The 3D-Settings toolbar (Figure 346) and its tools only become active when an object has been converted to 3D using the tool **Toggle Extrusion** and the converted object is then selected.

Available tools from left to right

- | | |
|---------------------|--------------|
| 1) Toggle Extrusion | 6) Depth |
| 2) Tilt Down | 7) Direction |
| 3) Tilt Up | 8) Lighting |
| 4) Tilt Left | 9) Surface |
| 5) Tilt Right | 10) 3D Color |

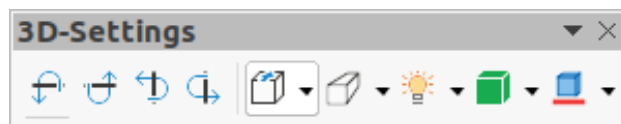

Figure 346: 3D-Settings toolbar

The following tools on this toolbar have a triangle ▼ on the right of the icon. Click on this triangle to open a drop-down menu giving access to various options as follows:

- **Depth** – 3D extrusion depth – *0cm; 1cm; 2.5cm; 5cm; 10cm; Infinity; Custom*. The measurement unit depends on the settings in **Tools > Options > LibreOffice Draw > General**.
- **Direction** – 3D extrusion direction and type – *Parallel; Perspective*.
- **Lighting** – lighting direction and lighting level of 3D extrusion – *Bright; Normal; Dim*.
- **Surface** – surface type of 3D extrusion – *Wire Frame; Matt; Plastic; Metal*.
- **3D Color** – color of 3D extrusion. Select a color from one of the available color palettes.

Align Objects

The Align Objects toolbar (Figure 347) provides tools for aligning several objects in a drawing to improve the visual impact of a drawing.

Available tools from left to right

- | | |
|-------------|-----------|
| 1) Left | 4) Top |
| 2) Centered | 5) Center |
| 3) Right | 6) Bottom |

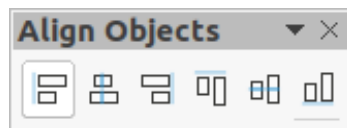

Figure 347: Align Objects toolbar

Comments

The Comments toolbar (Figure 348) provides tool for adding, deletion, and navigation of comments in a drawing. To use comments, it is recommended to add the name and initials of all users in **Tools > Options > LibreOffice > User Data** so that comments can be easily identified.

Available tools from left to right

- | | |
|--|------------------------|
| 1) Comment (<i>Ctrl+Alt+C</i>) (macOS <i>⌘+⌘+C</i>) | 3) Next Comment |
| 2) Previous Comment | 4) Delete Comment |
| | 5) Delete All Comments |

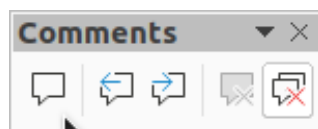

Figure 348: Comments toolbar

Distribute Selection

The Distribute Selection toolbar (Figure 349) provides tools to distribute three or more selected objects evenly along the horizontal axis or vertical axis. Also, the spacing between objects can be evenly distributed.

Available tools from left to right

- | | |
|-------------------------|-----------------------|
| 1) Horizontally Left | 5) Vertically Top |
| 2) Horizontally Center | 6) Vertically Center |
| 3) Horizontally Spacing | 7) Vertically Spacing |
| 4) Horizontally Right | 8) Vertically Bottom |



Figure 349: Distribute Selection toolbar

Drawing

The Drawing toolbar (Figure 350) provides the majority of the tools normally used to create graphic objects in a drawing.

Available tools from left to right

- | | |
|---|---|
| 1) Select | 21) Stars and Banners (Star Shapes in Visible Buttons) |
| 2) Zoom & Pan | 22) 3D Objects |
| 3) Zoom | 23) Rotate |
| 4) Text Box (F2) | 24) Flip |
| 5) Vertical Text | 25) Align Objects |
| 6) Insert Fontwork | 26) Arrange |
| 7) Line Color | 27) Select at least three objects to distribute (Distribution in visible Buttons) |
| 8) Fill Color | 28) Shadow |
| 9) Line | 29) Crop Image (Crop in Visible Buttons) |
| 10) Rectangle | 30) Filter |
| 11) Ellipse | 31) Points F8 (Edit Points (F8) in Visible Buttons) |
| 12) Line Ends with Arrow | 32) Show Glue Points Function (Glue Points in Visible Buttons) |
| 13) Lines and Arrows | 33) To Curve |
| 14) Curves and Polygons | 34) To Polygon |
| 15) Connectors | 35) To 3D |
| 16) Basic Shapes | 36) T0 3D Rotation Object |
| 17) Symbol Shapes | 37) Toggle Extrusion |
| 18) Block Arrows (Arrow Shapes in Visible Buttons)) | 38) Insert |
| 19) Flowchart (Flowchart Shapes in Visible Buttons) | 39) Controls |
| 20) Callouts (Callout Shapes in Visible Buttons) | |



Figure 350: Drawing toolbar

Some tool shapes on the Drawing toolbar change depending on the last tool that had previously been selected and used.

- Click on the triangle ▼ to the right of a tool to open a pop-up toolbar. Select the required shape to add to a drawing.
- To create a sub-toolbar, click and drag at the top of the pop-up toolbar to an empty area on the main window. The sub-toolbars for each object type and the various shapes available are shown Figures 351 to 360.

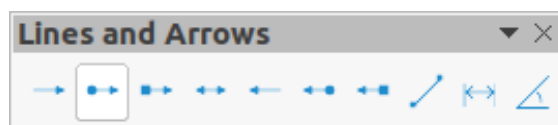

Figure 351: Lines and Arrows sub-toolbar

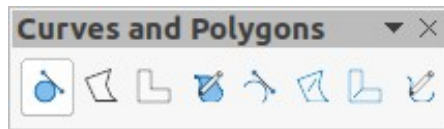

Figure 352: Curves and Polygons sub-toolbar



Figure 353: Connectors sub-toolbar



Figure 354: Basic Shapes sub-toolbar



Figure 355: Symbol Shapes sub-toolbar



Figure 356: Block Arrows sub-toolbar



Figure 357: Flowchart sub-toolbar



Figure 358: Callouts sub-toolbar



Figure 359: Stars and Banners sub-toolbar



Figure 360: 3D-Objects sub-toolbar

Edit Points

The Edit Points toolbar (Figure 361) provides tools for editing the points of a curve or an object that has been converted to a curve. The toolbar only becomes active when an object is selected and one of the following methods is used to open the toolbar:

- Click on **Edit Points** on the Drawing or Standard toolbar.
- Use the keyboard shortcut *F8*.

Available tools from left to right

- 1) Edit Points (*F8*)
- 2) Move Points
- 3) Insert Points
- 4) Delete Points
- 5) Convert to Curve
- 6) Close Bezier
- 7) Split Curve
- 8) Corner Point
- 9) Smooth Transition
- 10) Symmetric Transition
- 11) Eliminate Points



Figure 361: Edit Points toolbar

Find

The Find toolbar (Figure 362) opens by default in the bottom left corner of the Draw main window. This toolbar is normally docked at the bottom left of the Draw main window above the Status bar. However, it can be undocked and made into a floating toolbar.

Available tools from left to right

- 1) Close Find Bar
- 2) Find Text
- 3) Find Previous
- 4) Find Next
- 5) Find All
- 6) Match Case
- 7) Find and Replace (*Ctrl+H*) (macOS $\text{⌘}+\text{⌘}+F$)



Figure 362: Find toolbar

Fontwork

The Fontwork toolbar (Figure 363) is used to create graphical text objects in a drawing and provide the tools for editing the graphical text object. This toolbar only becomes active when a Fontwork graphical text object in the drawing has been selected.

Available tools from left to right

- 1) Insert Fontwork Text
- 2) Fontwork Shape
- 3) Fontwork Same Letter Heights
- 4) Fontwork Alignment
- 5) Fontwork Character Spacing
- 6) Toggle Extrusion

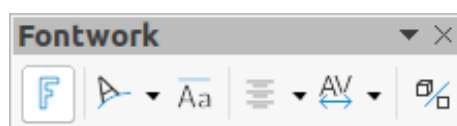

Figure 363: Fontwork toolbar

Some tools on the Fontwork toolbar have a triangle ▼ to the right of the tool. Click on the triangle to open a pop-up toolbar or drop-down option list.

- **Fontwork Shape** – select the required shape for the Fontwork graphical text object from the options available.
- **Fontwork Alignment** – select the paragraph alignment from the options available.
- **Fontwork Character Spacing** – select the required character spacing from the options available.

Form Controls

The Form Controls toolbar (Figure 364) provides the tools required to create an interactive form. This allows controls to be added to a form in a text, drawing, spreadsheet, presentation, or HTML document (for example a button that opens another drawing or document).

Available tools from left to right

- | | |
|--------------------------------|---------------------|
| 1) Select | 15) Formatted Field |
| 2) Design Mode | 16) Date Field |
| 3) Toggle Form Control Wizards | 17) Numerical Field |
| 4) Form Design | 18) Group Box |
| 5) Control Properties | 19) Time Field |
| 6) Form Properties | 20) Currency Field |
| 7) Label | 21) Pattern Field |
| 8) Text Box | 22) Table Control |
| 9) Check Box | 23) Navigation Bar |
| 10) Option Button | 24) Image Control |
| 11) List Box | 25) File Selection |
| 12) Combo Box | 26) Spin Button |
| 13) Push Button | 27) Scrollbar |
| 14) Image Button | |



Figure 364: Form Control toolbar

Form Design

The Form Design toolbar (Figure 365) opens a form in **Design Mode** so that it can be edited. Controls of the form cannot be activated or its contents edited when in **Design Mode**. However, the position and size of the controls can be changed, other properties edited, and added or deleted controls in **Design Mode**.

Available tools from left to right

- | | |
|---|---|
| 1) Select | 11) Group (<i>Ctrl+Shift+G</i>) (macOS ⌘+Shift+G) |
| 2) Control Properties | 12) Ungroup (<i>Ctrl+Alt+Shift+G</i>) (macOS ⌘+⇧+Shift+G) |
| 3) Form Properties | 13) Enter Group (<i>F3</i>) |
| 4) Position and Size (<i>F4</i>) | 14) Exit Group (<i>Ctrl+F3</i>) (macOS ⌘+F3) |
| 5) Form Navigator | 15) Align Objects |
| 6) Activation Order | 16) Open in Design Mode |
| 7) Add Field | 17) Display Grid |
| 8) Automatic Control Focus | 18) Snap to Grid |
| 9) Bring to Front (<i>Ctrl+Shift++</i>) (macOS ⌘+Shift++) | 19) Helplines While Moving |
| 10) Send to Back (<i>Ctrl+Shift+-</i>) (macOS ⌘+Shift+-) | |

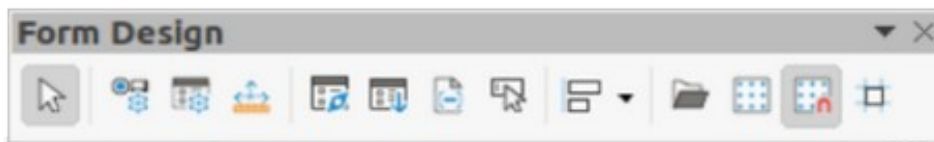

Figure 365: Form Design toolbar

Form Navigation

The Form Navigation toolbar (Figure 366) provides tools to edit a database table or control the data view. The toolbar is normally displayed at the bottom of a document that contains fields that are linked to a database. This toolbar is only active when forms are connected to a database; an inactive toolbar is shown in Figure 366.

The Form Navigation toolbar also allows movement within records as well as inserting and deleting records. If data is saved in a form, the changes are transferred to the database. This toolbar also provides tools providing sort, filter, and search functions for data records.

Available tools from left to right

- | | |
|-------------------------|--------------------------|
| 1) Find Record | 13) Delete Record |
| 2) Record | 14) Refresh |
| 3) Absolute Record | 15) Refresh Control |
| 4) Text -> Record | 16) Sort |
| 5) Total No. of Records | 17) Sort Ascending |
| 6) First Record | 18) Sort Descending |
| 7) Previous Record | 19) AutoFilter |
| 8) Next Record | 20) Apply Filter |
| 9) Last Record | 21) Form-Based Filters |
| 10) New Record | 22) Reset Filter/Sort |
| 11) Save Record | 23) Data source as Table |
| 12) Undo: Data entry | |



Figure 366: Form Navigation toolbar

Glue Points

The Glue Points toolbar (Figure 367) provides tools to insert a glue point or modify the properties of a glue point. A glue point is a point where a connector is attached to an object. By default, LibreOffice automatically places a glue point at the center of each side of the bounding rectangle for every object created.

Available tools from left to right

- | | |
|--------------------------|---------------------------------|
| 1) Insert Glue Point | 7) Glue Point Horizontal Left |
| 2) Exit Direction Left | 8) Glue Point Horizontal Center |
| 3) Exit Direction Top | 9) Glue Point Horizontal Right |
| 4) Exit Direction Right | 10) Glue Point Vertical Top |
| 5) Exit Direction Bottom | 11) Glue Point Vertical Center |
| 6) Glue Point Relative | 12) Glue Point Vertical Bottom |

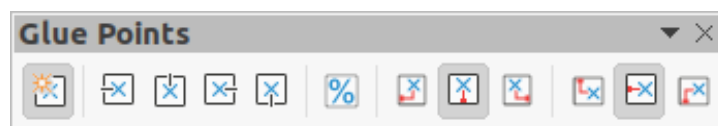

Figure 367: Glue Points toolbar

Image

The Image toolbar (Figure 368) provides tools to edit, modify, align, reposition and resize images. The toolbar only becomes active and available when an image is selected in a drawing. The Image toolbar automatically replaces the Line and Filling toolbar when it becomes active.

Available tools from left to right

- | | |
|--|------------------------|
| 1) Position and Size (<i>F4</i>) | 17) Line Style |
| 2) Align Objects | 18) Line Width |
| 3) Left | 19) Line Color |
| 4) Centered | 20) Area Style/Filling |
| 5) Right | 21) Fill Color |
| 6) Top | 22) Shadow |
| 7) Center | 23) Filter |
| 8) Bottom | 24) Image Mode |
| 9) Arrange | 25) Crop |
| 10) Bring to Front (<i>Ctrl+Shift++</i>) (macOS ⌘+Shift++) | 26) Vertically |
| 11) Bring Forward (<i>Ctrl++</i>) (macOS ⌘++) | 27) Horizontally |
| 12) Send Backward (<i>Ctrl+-</i>) (macOS ⌘+-) | 28) Transformations |
| 13) Send to Back (<i>Ctrl+Shift+-</i>) (macOS ⌘+Shift+-) | 29) Transparency |
| 14) In Front of Object | 30) Color |
| 15) Behind Object | 31) Line |
| 16) Reverse | 32) Area |
| | 33) Animation |
| | 34) Interaction |

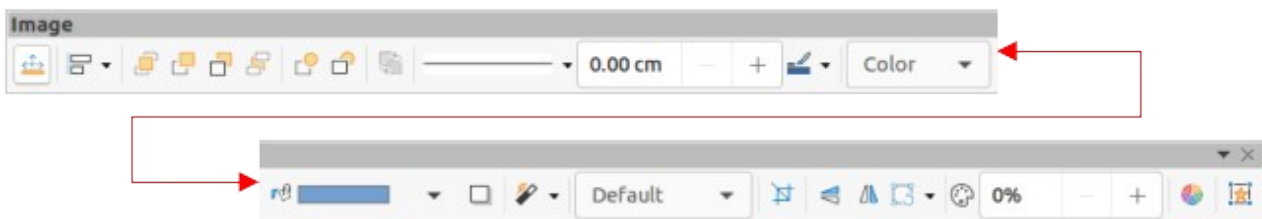

Figure 368: Image toolbar

Insert

The Insert toolbar (Figure 369) provides tools to insert different types of objects into a drawing.

Available tools from left to right

- | | |
|--------------------------|---|
| 1) New Page | 6) Insert Audio or Video (Media in Visible Buttons) |
| 2) Floating Frame | 7) Formula Object (<i>Ctrl+Alt+=</i>) (macOS ⌘+⌘+=) |
| 3) Insert Page from File | 8) Chart |
| 4) Table | 9) OLE Object |
| 5) Image | |

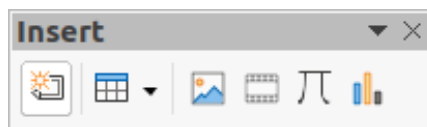

Figure 369: Insert toolbar

Legacy Circles and Ovals

The Legacy Circles and Ovals toolbar (Figure 370) provides tools to insert different types of circles and ovals into a drawing.

Available tools from left to right

- | | |
|-------------------|----------------|
| 1) Insert Ellipse | 3) Ellipse Pie |
| 2) Circle | 4) Circle Pie |

- | | |
|--------------------------|-------------------------------|
| 5) Ellipse Segment | 10) Circle Pie, Unfilled |
| 6) Circle Segment | 11) Ellipse Segment, Unfilled |
| 7) Ellipse, Unfilled | 12) Circle Segment, Unfilled |
| 8) Circle, Unfilled | 13) Arc |
| 9) Ellipse Pie, Unfilled | 14) Circle Arc |



Figure 370: Legacy Circles and Ovals toolbar

Legacy Rectangles

The Legacy Rectangles toolbar (Figure 371) provides tools to insert different types of rectangles and squares into a drawing.

Available tools from left to right

- | | |
|-----------------------|--------------------------------|
| 1) Insert Rectangle | 5) Rectangle, Unfilled |
| 2) Square | 6) Square, Unfilled |
| 3) Rectangle, Rounded | 7) Rounded Rectangle, Unfilled |
| 4) Rounded Square | 8) Rounded Square, Unfilled |

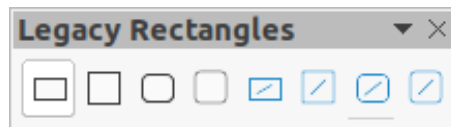

Figure 371: Legacy Rectangles toolbar

Line and Filling

The Line and Filling toolbar (Figure 372) provides tools and drop-down lists for editing lines, arrows, and object borders. The tools available vary depending on the type of object selected for editing.

Available tools from left to right

- | | |
|--|--|
| 1) Position and Size (<i>F4</i>) | 18) Line Width |
| 2) Align Objects | 19) Line Color |
| 3) Left | 20) Area Style/Filling |
| 4) Centered | 21) Fill Color |
| 5) Right | 22) Shadow |
| 6) Top | 23) Arrow Style |
| 7) Center | 24) Vertically |
| 8) Bottom | 25) Horizontally |
| 9) Arrange | 26) Transformations |
| 10) Bring to Front (<i>Ctrl+Shift++</i>) (macOS ⌘+Shift++) | 27) Line |
| 11) Bring Forward (<i>Ctrl++</i>) (macOS ⌘++) | 28) Area |
| 12) Send Backward (<i>Ctrl+-</i>) (macOS ⌘+-) | 29) 3D Effects |
| 13) Send to Back (<i>Ctrl+Shift+-</i>) (macOS ⌘+Shift+-) | 30) Image Map |
| 14) In Front of Object | 31) Animation |
| 15) Behind Object | 32) Interaction |
| 16) Reverse | 33) Show the Styles Sidebar (<i>F11</i>) |
| 17) Line Style | 34) Display Grid |
| | 35) Helplines While Moving |

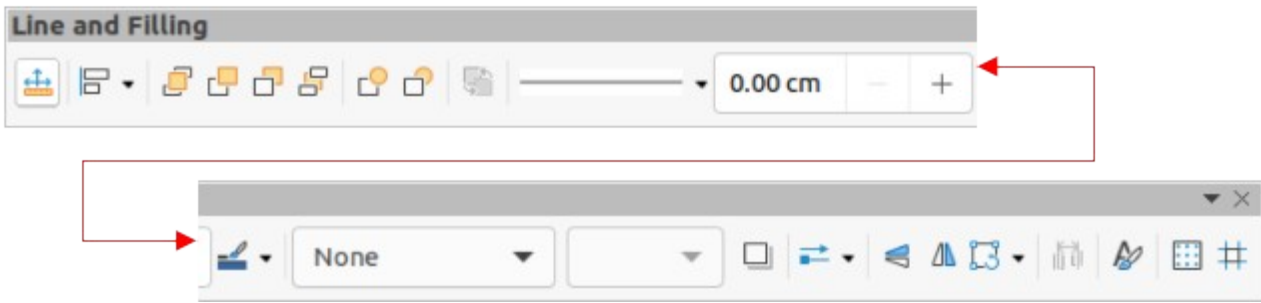

Figure 372: Line and Filling toolbar

Master View

The Master View toolbar (Figure 373) provides tools to create a new master page, rename a master page, delete a master page, and close master view. This toolbar is only active when Draw is in master view.

Available tools from left to right

- | | |
|------------------|----------------------|
| 1) New Master | 3) Delete Master |
| 2) Rename Master | 4) Close Master View |

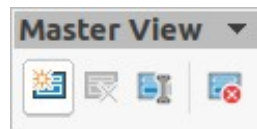

Figure 373: Master View toolbar

Media Playback

The Media Playback toolbar (Figure 374) provides the standard tools required to insert, view, play, and listen to audio and video files. The toolbar only becomes active when an audio or video file is selected. Draw supports many different media formats depending on the computer operating system being used.

Available tools from left to right

- | | |
|--------------------------|-------------|
| 1) Insert Audio or Video | 6) Position |
| 2) Play | 7) Mute |
| 3) Pause | 8) Volume |
| 4) Stop | 9) View |
| 5) Repeat | |

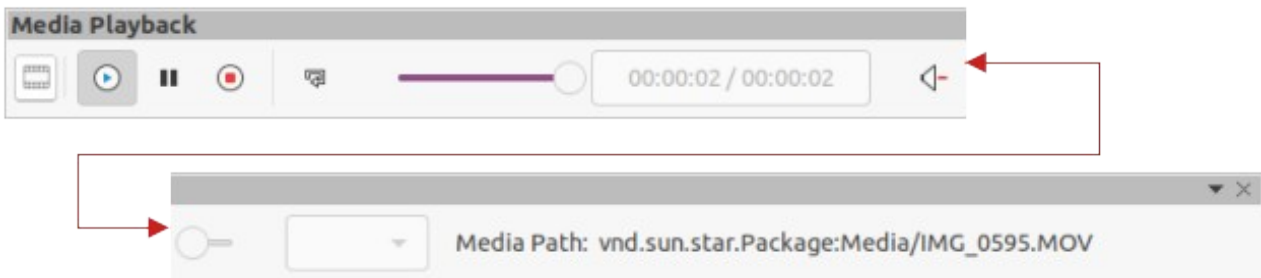

Figure 374: Media Playback toolbar

Options

The Options toolbar (Figure 375) provides tools for editing various settings for newly created drawings, for example how objects snap to the grid when being moved or resized.

Available tools from left to right

- | | |
|--|-----------------|
| 1) Rotation Mode after Clicking Object | 2) Display Grid |
|--|-----------------|

- | | |
|---------------------------|-----------------------------------|
| 3) Display Snap Guides | 9) Snap to Object Points |
| 4) Helplines While Moving | 10) Allow Quick Editing |
| 5) Snap to Grid | 11) Select Text Area Only |
| 6) Snap to Snap Guides | 12) Double-click to edit Text |
| 7) Snap to Page Margins | 13) Modify Object with Attributes |
| 8) Snap to Object Borders | 14) Exit All Groups |



Figure 375: Options toolbar

Redaction

The Redaction toolbar (Figure 376) is used to block portions of a drawing protecting sensitive information and helps enterprises and organizations to comply with regulations on confidentiality or privacy.

When a redacted drawing is exported to a new drawing, any redacted portions are removed from the new drawing and replaced by redaction blocks of pixels. This prevents any attempt to restore or copy the original contents. A redacted drawing is often exported to PDF for publication or sharing.

Available tools from left to right

- | | |
|----------------------------|----------------------------|
| 1) Rectangle | 4) Redacted Export (Black) |
| 2) Freeform | 5) PDF |
| 3) Redacted Export (White) | |



Figure 376: Redaction toolbar

Standard

The Standard toolbar (Figure 377) is common to all LibreOffice components and provides the most common tools when creating and editing documents using LibreOffice. The Standard toolbar differs between LibreOffice components to allow for different toolsets used in creating the different types of documents.

Available tools from left to right

- | | |
|---|---|
| 1) Load URL | 17) Clone Formatting (Clone in Visible Buttons) |
| 2) New (<i>Ctrl+N</i>) (macOS ⌘+N) | 18) Clear (<i>Ctrl+Shift+M</i>) (macOS <i>Shift+M</i>) |
| 3) Templates (<i>Ctrl+Shift+N</i>) (macOS ⌘+ <i>Shift+N</i>) | 19) Undo (<i>Ctrl+Z</i>) (macOS ⌘+Z) |
| 4) Open (<i>Ctrl+O</i>) (macOS ⌘+O) | 20) Redo (<i>Ctrl+Y</i>) (macOS ⌘+Y) |
| 5) Open Remote | 21) Spelling (<i>F7</i>) |
| 6) Save (<i>Ctrl+S</i>) (macOS ⌘+S) | 22) Auto Spellcheck (<i>Shift+F7</i>) |
| 7) Save As (<i>Ctrl+Shift+S</i>) (macOS ⌘+ <i>Shift+S</i>) | 23) Display Grid (Grid in Visible Buttons) |
| 8) Email | 24) Helplines While Moving |
| 9) Edit Mode (<i>Ctrl+Shift+M</i>) (macOS ⌘+ <i>Shift+M</i>) | 25) Zoom & Pan |
| 10) Export | 26) Object Zoom |
| 11) Export Directly as PDF | 27) Zoom |
| 12) Print Directly | 28) Table |
| 13) Print (<i>Ctrl+P</i>) (macOS ⌘+P) | 29) Insert Image (Image in Visible Buttons) |
| 14) Cut (<i>Ctrl+X</i>) (macOS ⌘+X) | 30) Insert Chart (Chart in Visible Buttons) |
| 15) Copy (<i>Ctrl+C</i>) (macOS ⌘+C) | 31) Insert Text Box (<i>F2</i>) (Text Box in Visible Buttons) |
| 16) Paste (<i>Ctrl+V</i>) (macOS ⌘+V) | |

- | | |
|---|---|
| 32) Insert Special Characters (Symbol in Visible Buttons) | 45) Edit Points (<i>F8</i>) |
| 33) Vertical Text | 46) Glue Points |
| 34) Insert Fontwork Text | 47) Toggle Extrusion |
| 35) Insert Hyperlink (<i>Ctrl+K</i>) (macOS $\text{⌘}+K$) (Hyperlink in Visible Buttons) | 48) Show Draw Functions (Draw Functions in Visible Buttons) |
| 36) Transformations | 49) LibreOffice Help |
| 37) Flip | 50) What's That |
| 38) Position and Size (<i>F4</i>) | 51) Go to First Page |
| 39) Align Objects | 52) Go to Previous Page |
| 40) Distribution | 53) Go to Next Page |
| 41) Shadow | 54) Go to Last Page |
| 42) Crop | 55) Move Page to Start |
| 43) Filter | 56) Move Page Up |
| 44) 3D Effects | 57) Move Page Down |
| | 58) Move Page to End |

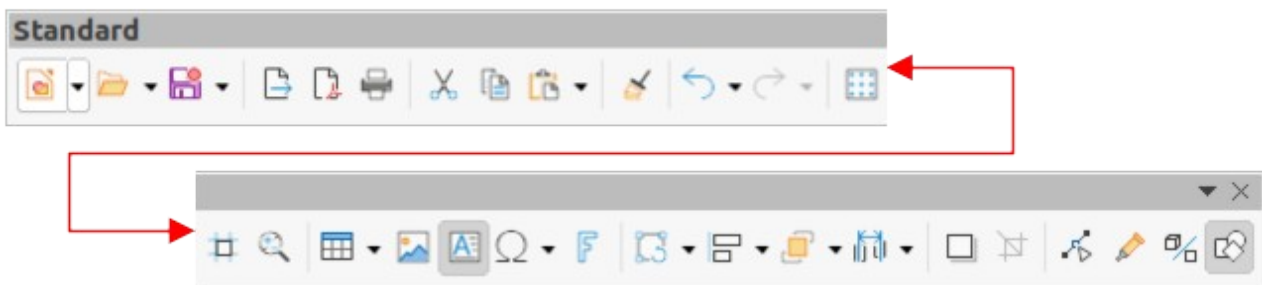

Figure 377: Standard toolbar

Standard (Viewing Mode)

The Standard (Viewing Mode) toolbar (Figure 378) provides tools to save, edit, and distribute a drawing.

Available tools from left to right

- | | |
|--|--|
| 1) Save As (<i>Ctrl+Shift+S</i>) (macOS $\text{⌘}+S$) | 7) Print Directly |
| 2) Edit Mode (<i>Ctrl+Shift+M</i>) (macOS $\text{⌘}+Shift+M$) | 8) Print (<i>Ctrl+P</i>) (macOS $\text{⌘}+P$) |
| 3) Read Only Mode | 9) Copy (<i>Ctrl+C</i>) (macOS $\text{⌘}+C$) |
| 4) Attach to Email (Email in Visible Buttons) | 10) Find and Replace (<i>Ctrl+H</i>) (macOS $\text{⌘}+⌘+F$) |
| 5) Export Directly as PDF | 11) Zoom |
| 6) EPUB | 12) Start from First Slide (<i>F5</i>) |

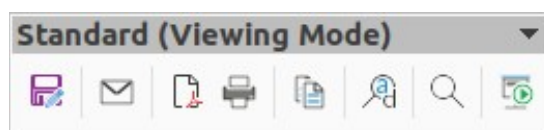

Figure 378: Standard (Viewing Mode) toolbar

Table

The Table toolbar (Figure 379) provides tools and options to edit and format a table placed in a drawing. This toolbar only becomes active when a table is selected.

Available tools from left to right

- | | |
|---------------------------------|---|
| 1) Table | 8) Split Cells |
| 2) Border Style | 9) Optimize |
| 3) Border Color | 10) Align Top (Top in Visible Buttons) |
| 4) Borders (Shift to overwrite) | 11) Center Vertically (Center in Visible Buttons) |
| 5) Area Style/Filling | 12) Align Bottom (Bottom in Visible Buttons) |
| 6) Fill Color | 13) Insert Row Above |
| 7) Merge Cells | 14) Insert Row Below |

- | | |
|--------------------------|----------------------|
| 15) Insert Column Before | 20) Select Table |
| 16) Insert Column After | 21) Select Column |
| 17) Delete Row | 22) Select Row |
| 18) Delete Column | 23) Table Design |
| 19) Delete Table | 24) Table Properties |

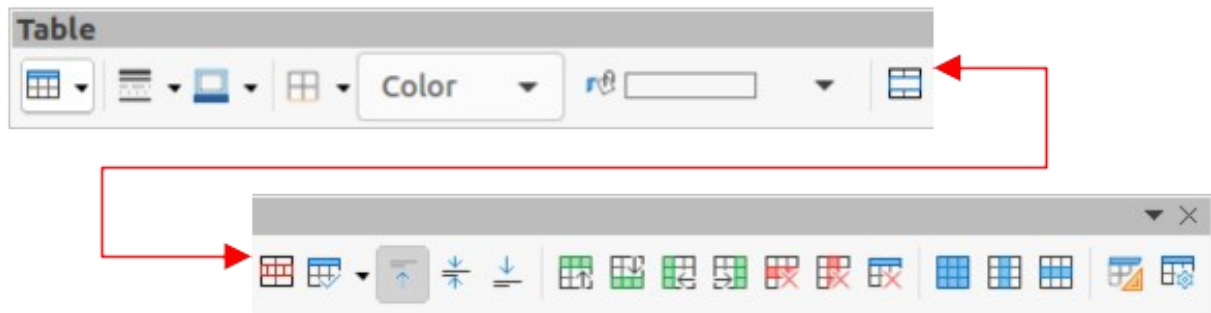

Figure 379: Table toolbar

Text Formatting

The Text Formatting toolbar (Figure 380) provides tools for formatting text and alignment commands. This toolbar becomes active when text in a text box or graphic object has been selected and it automatically replaces the Line and Filling toolbar.

Available tools from left to right

- | | |
|--|--|
| 1) Font Name | 22) Toggle Ordered List (Ordered List in Visible Buttons) |
| 2) Font Size | 23) Outline Format |
| 3) Increase Font Size (<i>Ctrl+I</i>) (macOS $\text{⌘}+I$)
(Increase in Visible Buttons) | 24) Align Left (<i>Ctrl+L</i>) (macOS $\text{⌘}+L$) (Left in Visible Buttons) |
| 4) Decrease Font Size (<i>Ctrl+J</i>) (macOS $\text{⌘}+J$)
(Decrease in Visible Buttons) | 25) Align Center (<i>Ctrl+E</i>) (macOS $\text{⌘}+E$) (Center in Visible Buttons) |
| 5) Bold (<i>Ctrl+B</i>) (macOS $\text{⌘}+B$) | 26) Align Right (<i>Ctrl+R</i>) (macOS $\text{⌘}+R$) (Right in Visible Buttons) |
| 6) Italic (<i>Ctrl+I</i>) (macOS $\text{⌘}+I$) | 27) Justified (<i>Ctrl+J</i>) (macOS $\text{⌘}+J$) |
| 7) Underline (<i>Ctrl+U</i>) (macOS $\text{⌘}+U$) | 28) Align Top (Top in Visible Buttons) |
| 8) Double Underline | 29) Center Vertically (Center in Visible Buttons) |
| 9) Strikethrough | 30) Align Bottom (Bottom in Visible Buttons) |
| 10) Overline | 31) Set Line Spacing (Line Spacing in Visible Buttons) |
| 11) Superscript (<i>Ctrl+Shift+P</i>) (macOS $\text{⌘}+Shift+P$) | 32) Character Spacing |
| 12) Subscript (<i>Ctrl+Shift+B</i>) (macOS $\text{⌘}+Shift+B$) | 33) Increase Paragraph Spacing (Increase in Visible Buttons) |
| 13) Toggle Shadow (Shadow in Visible Buttons) | 34) Decrease Paragraph Spacing (Decrease in Visible Buttons) |
| 14) Apply outline attribute to font (Outline Font Effect in Visible Buttons) | 35) Text direction from left to right |
| 15) Clear (<i>Ctrl+Shift+M</i>) (macOS $\text{⌘}+Shift+M$) | 36) Text direction from top to bottom |
| 16) lowercase | 37) Left-To-Right |
| 17) UPPERCASE | 38) Right-To-Left |
| 18) SMALL CAPITALS | 39) Select All (<i>Ctrl+A</i>) (macOS $\text{⌘}+A$) |
| 19) Font Color | 40) Character |
| 20) Character Highlighting Color | 41) Paragraph |

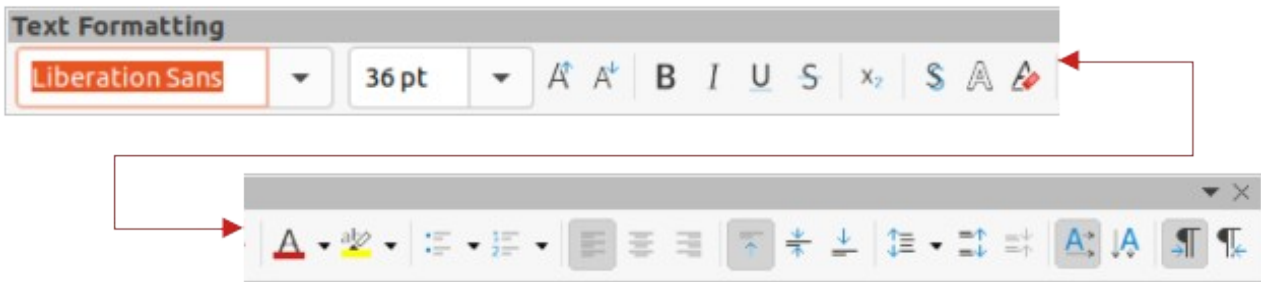

Figure 380: Text Formatting toolbar

Transformations

The Transformations toolbar (Figure 381) provides tools to modify the shape, orientation, or fill of selected objects.

Available tools from left to right

- | | |
|--------------------------------|---|
| 1) Rotate | 6) Distort |
| 2) Flip | 7) Interactive transparency tool (Transparency tool in Visible Buttons) |
| 3) In 3D Rotation Object | 8) Interactive gradient tool (Gradient tool in Visible Buttons) |
| 4) Set in Circle (perspective) | |
| 5) Set to circle (slant) | |

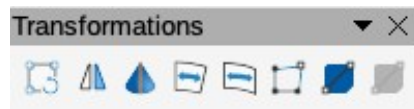

Figure 381: Transformations toolbar

Zoom

The Zoom toolbar (Figure 382) provides tools to reduce or enlarge the screen display of the current drawing.

Available tools from left to right

- | | |
|------------------|--|
| 1) Zoom In | 7) Page Width |
| 2) Zoom Out | 8) Optimal View (Optimal in Visible Buttons) |
| 3) 100% | 9) Object Zoom |
| 4) Zoom Previous | 10) Zoom & Pan |
| 5) Zoom Next | 11) Shift |
| 6) Entire Page | |



Figure 382: Zoom toolbar



Draw Guide

Working With Vector Graphics

About this book:

This book covers the main features of Draw, the vector graphics component of LibreOffice. Using Draw, a wide variety of graphical images can be created.

Vector graphics store and display a picture as simple geometric elements such as lines, circles, and polygons rather than as a collection of pixels (points on the screen). This permits simpler storage and supports precise scaling of the picture elements.

Draw is fully integrated into LibreOffice. This simplifies exchanging graphics with Writer, Calc, and Impress. Images can be exported in many formats for use in other programs.

About the authors:

This book was written by volunteers from the LibreOffice community.

A PDF version of this book can be downloaded free from:

<https://documentation.libreoffice.org/en/>

About LibreOffice:

LibreOffice is the free, libre, and open source personal productivity suite from The Documentation Foundation. It runs on Windows, macOS, and GNU/Linux. Support and documentation is free from a large, dedicated community of users, contributors, and developers.

Get involved as a volunteer and work in many areas: development, quality assurance, documentation, translation, user support, and more.

Download LibreOffice for free from <https://libreoffice.org/downloads/>

For commercial use:

Work with certified LibreOffice professionals for any business needs, from deployment or conversion from other office suits, staff training, or custom development needs.

For information on professional support services, go to

<https://www.libreoffice.org/get-help/professional-support/>