

LibreOffice

Community

LibreOffice Documentation Team

Draw Guide



7.5

LibreOffice is a registered trademark of The Document Foundation
Further Information is available at libreoffice.org

Copyright

This document is Copyright © 2023 by the LibreOffice Documentation Team. Contributors are listed below. This document maybe distributed and/or modified under the terms of either the GNU General Public License (<https://www.gnu.org/licenses/gpl.html>), version 3 or later, or the Creative Commons Attribution License (<https://creativecommons.org/licenses/by/4.0/>), version 4.0 or later. All trademarks within this guide belong to their legitimate owners.

Contributors

Contributors for this edition:

Peter Schofield Socks Eight

Contributors for previous editions:

Claire Wood	John A Smith	Michele Zarri	Vipul Gupta
Dave Barton	John Cleland	Peter Schofield	Winston Min Tjong
Elzett Kotze	Kees Kriek	Rachel Kartch	
Hazel Russman	Low Song Chuan	Regina Henschel	
Jean Hollis Weber	Martin Fox	Ron Faile Jr.	

Feedback

Please direct any comments or suggestions about this document to the Documentation Team mailing list: loguides@community.documentfoundation.org.

Note

Everything sent to a mailing list, including email addresses and any other personal information that is written in the message, is publicly archived and cannot be deleted.

Publication date and software version

Published August 2023. Based on LibreOffice 7.5 Community.
Other versions of LibreOffice may differ in appearance and functionality.

Contents

Copyright.....	2
Preface.....	7
Who is this user guide for?.....	8
What is in this user guide?.....	8
What is LibreOffice?.....	8
Minimum requirements for using LibreOffice.....	8
How to get LibreOffice.....	8
Installing LibreOffice.....	9
Setting up and customizing LibreOffice.....	9
Extensions and add-ons.....	9
Where to get more help.....	9
What you see maybe different.....	11
Using LibreOffice on macOS.....	13
Who wrote this user guide?.....	14
Frequently asked questions.....	14
What is new in LibreOffice 7.5?.....	15
Chapter 1, Introducing Draw.....	17
Introduction.....	18
Draw main window.....	18
Choosing and defining colors.....	26
Grid, snap guides, and helplines.....	28
Chapter 2, Drawing Basic Shapes.....	29
Introduction.....	30
Drawing basic shapes.....	30
Gluepoints and connectors.....	41
Drawing geometric shapes.....	42
Adding, inserting and formatting text.....	45
Chapter 3, Working with Objects.....	47
Introduction.....	48
Selecting objects.....	48
Positioning and adjusting objects.....	49
Using grid and snap functions.....	60
Using Helplines.....	65
Changing object shape.....	66
Chapter 4, Changing Object Attributes.....	79
Formatting lines.....	80
Area fills.....	89
Working with area fills.....	91
Working with shadows.....	107
Working with transparencies.....	109
Drawing styles.....	110

Special effects.....	115
Chapter 5, Combining Multiple Objects.....	123
Grouping objects.....	124
Combining, splitting, breaking, and connecting.....	126
Merging, subtracting, or intersecting objects.....	129
Duplication and cross-fading.....	132
Positioning objects.....	135
Chapter 6, Editing Images.....	139
Introduction.....	140
Importing images.....	140
Exporting images.....	144
Formatting images (raster objects).....	145
Cropping images.....	149
Image filters.....	152
Replacing colors.....	157
Conversion.....	159
Chapter 7 Working with 3D Objects.....	163
Introduction.....	164
3D object types.....	164
Creating 3D objects.....	165
Editing 3D objects.....	168
Combining objects.....	181
Assembling 3D objects.....	183
Chapter 8, Connections, Flowcharts, and Organization Charts.....	185
Connectors and gluepoints.....	186
Flowcharts.....	195
Organization charts.....	196
Chapter 9, Adding and Formatting Text.....	199
Introduction.....	200
Text mode.....	200
Text boxes.....	201
Text in Draw objects.....	208
Pasting text.....	210
Formatting text.....	211
Unordered or ordered lists.....	215
Text columns.....	218
Text animation.....	221
Text callouts.....	222
Tables in Draw.....	225
Using fields.....	235
Using hyperlinks.....	236
Image maps.....	241
Fontwork.....	243

Chapter 10, Printing, Exporting and Emailing.....	247
Introduction.....	248
Default printer setup.....	248
Quick printing.....	248
Linux or Windows printing.....	249
macOS printing.....	252
Printing examples.....	257
Exporting.....	260
Emailing documents.....	264
Digital signatures.....	265
Removing personal data.....	265
Redaction.....	267
Chapter 11, Advanced Draw Techniques.....	269
Drawing pages.....	270
Master pages.....	274
Templates.....	279
Multiple layers.....	287
Dimensioning.....	291
Drawing to scale.....	295
Multiple views of a drawing.....	296
Gallery.....	297
Colors.....	300
Bézier curves.....	308
Adding comments.....	311
Coordinate system.....	312
Chapter 12, User Interface Variants.....	315
Introduction.....	316
Selecting user interface.....	316
Standard Toolbar UI.....	317
Tabbed UI.....	317
Single Toolbar & Sidebar UI.....	323
Tabbed Compact UI.....	324
Groupedbar Compact UI.....	325
Contextual Single UI.....	325
Appendix A, Keyboard Shortcuts.....	327
Introduction.....	328
macOS keyboard shortcuts.....	328
Draw function key and keyboard shortcuts.....	329
Menu function key and keyboard shortcuts.....	332
General function key and keyboard shortcuts.....	336
Toolbar function key and keyboard shortcuts.....	337
Appendix B, Toolbars.....	343
Introduction.....	344

Using toolbars.....	344
Toolbars.....	347
Sub-toolbars.....	361



LibreOffice
Community



Draw Guide 7.5

Preface

Drawing Vector Graphics in LibreOffice

Who is this user guide for?

Anyone who wants to quickly acquire knowledge on LibreOffice Draw and is new to drawing software, or maybe familiar with another office suite, will find this user guide very useful.

LibreOffice is an open-source office productivity software suite containing capabilities for word processing, spreadsheets, presentations, graphics, databases, and formula editing. LibreOffice Draw is the vector graphics drawing application for LibreOffice where a wide variety of graphical images can be easily and quickly created. Drawings can be exported in several file formats, for example, PDF, HTML, and numerous graphic formats.

What is in this user guide?

This user guide introduces the main features of LibreOffice Draw. Although Draw is a vector graphics drawing tool, it can also perform some operations on raster graphics (pixels) such as photographs.

A few examples of drawing functions are as follows:

- Layer management, snap functions and grid-point system
- Dimensions and measurement display
- Connectors for making organization charts
- 3D functions that enable small 3D drawings to be created (with texture and lighting effects), drawing and page-style integration, and Bézier curves.

What is LibreOffice?

LibreOffice is a freely available, fully-featured, open source office productivity suite that is compatible with other major office suites and is available on a variety of platforms. The native file format used is Open Document Format (ODF). However, LibreOffice can also open and save documents in many other formats, including those used by several versions of Microsoft Office. For more information, see the *Getting Started Guide*.

Minimum requirements for using LibreOffice

LibreOffice 7.5 requires one of the following operating systems:

- Linux x64 (deb) and Linux x64 (rpm)
- Mac OS X (Aarch64/Apple Silicon)
- macOS x86_64 (10.14 Mojave or higher)
- Windows x86_64 (Windows 7 or newer required).

For a detailed list of requirements and operating systems supported, see the LibreOffice website, <https://www.libreoffice.org/get-help/system-requirements/>.

How to get LibreOffice

Versions of LibreOffice for Windows, Linux, and macOS are freely available and can be downloaded from <https://www.libreoffice.org/download>. Linux users will also find LibreOffice included free in many of the latest distributions.

Linux, Vanilla, and other versions may differ in a few features from the descriptions in this user guide. LibreOffice is included in many of the latest Linux distributions, for example Ubuntu. Portable and other versions of LibreOffice are listed on the download page. LibreOffice is also available in the Microsoft Store and Apple Mac App Store at a low and attractive price. The profits from the sale of LibreOffice are invested to support the development of the LibreOffice project.

Installing LibreOffice

Information on installing LibreOffice on the various supported operating systems can be found at this web page: <https://www.libreoffice.org/get-help/install-howto/>. When LibreOffice is acquired through official app stores, follow the installation instructions provided by the store.

Setting up and customizing LibreOffice

After installation, to change the default settings (options) in LibreOffice to suit working requirements and preferences, go to **Tools > Options** on the Menu bar (mac OS **LibreOffice > Preferences**).

Tip

Some settings are intended for power users and programmers. If it is difficult to understand what an option does, LibreOffice recommends leaving the option on its default setting unless instructions in this user guide recommend changing the setting.

Settings are described in LibreOffice Help and the *Getting Started Guide*. These two sources provide information on how to customize menus, toolbars, and keyboard shortcuts in LibreOffice Draw, add new menus and toolbars, and assign macros to events.

Extensions and add-ons

Functionality can be added to LibreOffice using extensions. Several extensions are installed with LibreOffice and more extensions can be installed from the official extensions repository, <https://extensions.libreoffice.org/> or from other sources. See the *Getting Started Guide* for more information on installing extensions.

Where to get more help

This user guide and other LibreOffice user guides, the built-in Help system, and user support systems assume that users are familiar with computers and basic functions such as starting a program, opening and saving files.

Help system

LibreOffice comes with an extensive Help system and this can be used as the first line of support. Windows and Linux users can choose to download and install the offline Help for use when not connected to the Internet. Offline Help is installed with the MacOS version of LibreOffice.

To display the LibreOffice Help, press *F1* or go to **Help > LibreOffice Help** on the Menu bar. If the offline help is not installed on a computer, but connected to the Internet, a dialog opens giving the option to **Read Help Online**. Select this option and the default web browser opens at the LibreOffice online help pages in the LibreOffice website.

The Help menu also includes links to other LibreOffice information, support facilities and resources that may be useful to LibreOffice users.

What's This?

For quick tips when a toolbar is visible, place the cursor over a tool icon to see a small tooltip box with a brief explanation of the tool function. For a more detailed explanation, select **Help > What's This?** Also **Extended Tips** can be activated by going to **Tools > Options > LibreOffice > General > Help** (macOS **LibreOffice > Preferences > LibreOffice > General > Help**) on the Menu bar and selecting the option *Extended Tips*. **Extended tips** provide a brief description about tools and commands. To display an extended tip, use the keyboard *Shift+F1*, then point to a tool or command.

User Guides

Opens the default browser at the Documentation page of the LibreOffice website <https://documentation.libreoffice.org/en/english-documentation/>. This page gives access to the LibreOffice User Guides and other useful information that can be opened in the default browser. Also, the User Guides are available in PDF format as a free download or to buy as printed copies.

Show Tip of the Day

Opens a small window with a random tip on how to use LibreOffice.

Search Commands

Opens a window where typing a few letters, or the name of a Menu bar command, for example, quickly finds where the command is located. Clicking on a command in the resulting list may open a relevant dialog or have other effects.

Get Help Online

Opens the default browser at the Ask LibreOffice forum of questions and answers from the LibreOffice community, <https://ask.libreoffice.org/en/questions/>.

Send Feedback

Opens the default browser at the Feedback page of the LibreOffice website <https://www.libreoffice.org/get-help/feedback/>. From this page, bugs can be reported, new features suggested and communicated with other users in the LibreOffice community.

Restart in Safe Mode

Opens a dialog window giving options to restart LibreOffice and reset the software to its default settings. Restarting in safe mode also provides an opportunity to restore LibreOffice from a backup.

Get Involved

Opens the default browser at the Get Involved page of the LibreOffice website, <https://www.libreoffice.org/community/get-involved/>. Choose a topic of interest to help improve the program.

Donate to LibreOffice

Opens the default browser at the Donation page for the LibreOffice website, <https://donate.libreoffice.org/> providing an opportunity to make a donation to support LibreOffice.

License Information

Outlines the licenses under which LibreOffice is made available.

Check for Updates

Opens a dialog and checks the LibreOffice website for updates for the software version. The dialog provides an opportunity to download and install any updates to LibreOffice.

About LibreOffice

Opens a dialog and displays information about the version of LibreOffice and the operating system being used. This information is often requested if the community is asked for help or assistance with the software (on macOS, this option is found under **LibreOffice** on the Menu bar).

Other free online support

The LibreOffice community not only develops software, but provides free, volunteer-based support. See Table 1 and the web page <https://www.libreoffice.org/get-help/>. For comprehensive online support from the community, look at mailing lists and the Ask LibreOffice website, <https://ask.libreoffice.org/en/questions/>. Other user websites also offer free tips and tutorials.

Table 1: Free support for LibreOffice users

Free LibreOffice support	
FAQs	Answers to frequently asked questions https://wiki.documentfoundation.org/Faq
Mailing lists	Free community support is provided by a network of experienced users https://www.libreoffice.org/get-help/mailling-lists/
Questions & Answers and Knowledge Base	Free community assistance is provided in a Question & Answer formatted web service. Search similar topics or open a new one in https://ask.libreoffice.org/en/questions The service is available in several other languages; just replace /en/ with de, es, fr, ja, ko, nl, pt, tr, and many others in the web address above.
Native language support	The LibreOffice website in various languages https://www.libreoffice.org/community/nlc/ Mailing lists for native languages https://wiki.documentfoundation.org/Local_Mailing_Lists Information about social networking https://wiki.documentfoundation.org/Website/Web_Sites_services
Accessibility options	Information about available accessibility options. https://www.libreoffice.org/get-help/accessibility/
OpenOffice Forum	Another forum that provides support for LibreOffice, among other open source office suites. https://forum.openoffice.org/en/forum/

Paid support and training

Support and training is available through service contracts from a vendor or consulting firm specializing in LibreOffice. For information about certified professional support, see The Document Foundation website: <https://www.documentfoundation.org/gethelp/support/>.

For schools, educational and research institutions, and large organizations, see <https://www.libreoffice.org/download/libreoffice-in-business/>.

What you see maybe different

Illustrations

LibreOffice runs on Windows, Linux, and macOS operating systems, each of which has several versions and can be customized by users (fonts, colors, themes, window managers). The illustrations in this guide were taken from a variety of computers and operating systems. Therefore, some illustrations will not look exactly like what is seen on a computer display.

Also, some dialogs may differ because of the settings selected in LibreOffice. Either use dialogs from the computer system (default) or dialogs provided by LibreOffice.

To change to using LibreOffice dialogs:

- 1) On Linux and Windows operating systems, go to **Tools > Options > LibreOffice > General** on the Menu bar to open the dialog for general options.
- 2) On a Mac operating system, go to **LibreOffice > Preferences > LibreOffice > General** on the Menu bar to open the dialog for general options.
- 3) Select *Use LibreOffice* dialogs in **Open/Save dialogs** to display the LibreOffice dialogs on a computer display, as shown in Figure 1.
- 4) Click **OK** to save the settings and close the dialog.

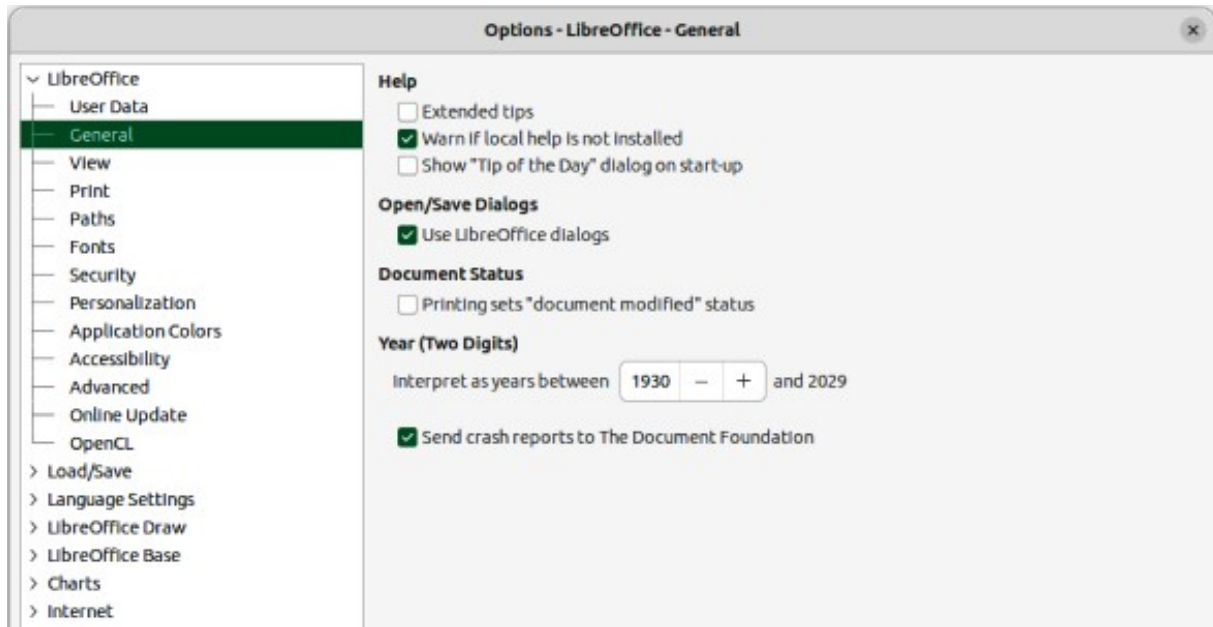

Figure 1: Options LibreOffice dialog — General page

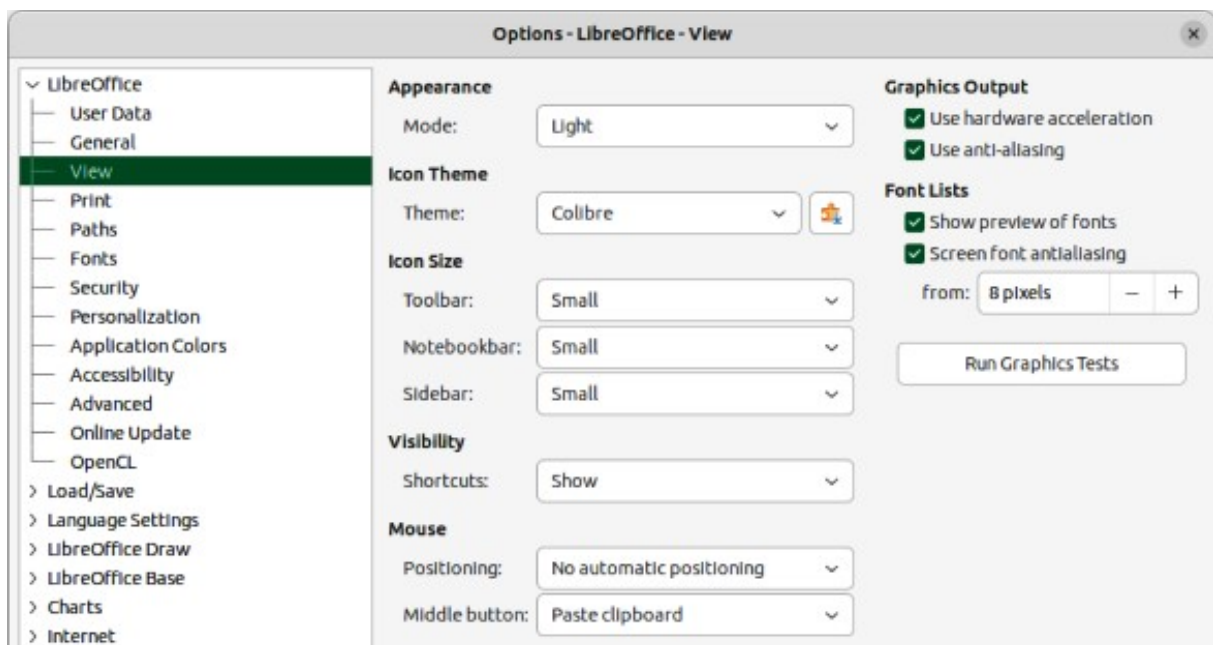

Figure 2: Options LibreOffice dialog — View page

Icons

The LibreOffice community has created icons for several icon sets, including Breeze, Colibre, Elementary, Sifr, and Tango. Each user can select a preferred set. The icons used to illustrate some of the many tools available in LibreOffice may differ from the ones used in this guide. The icons in this user guide have been taken from a LibreOffice installation that has been set to display the Colibre set of icons.

Change the icon set used in a LibreOffice installation as follows:

- 1) On Linux and Windows operating systems, go to **Tools > Options > LibreOffice > View** on the Menu bar to open the dialog for view options.
- 2) On a Mac operating system, go to **LibreOffice > Preferences > LibreOffice > View** on the Menu bar to open the dialog for view options.
- 3) In **Icon Theme** select Colibre (SVG) from the options available in the drop down list as shown in Figure 2.
- 4) In **Icon Size**, select **Small** from the drop down lists for *Toolbar*, *Notebookbar* and *Sidebar*, as shown in Figure 2.
- 5) Click **OK** to save the settings and close the dialog.

Notes

Some Linux operating systems, for example Ubuntu, include LibreOffice as part of the installation and may not include the Colibre icon set. This icon set can be downloaded from the software repository for the Linux operating system being used.

Some previously included icon sets are now available only as extensions; see <https://extensions.libreoffice.org/?Tags%5B%5D=49> or search for specific ones. For example, the People Gallery is available from <https://extensions.libreoffice.org/en/extensions/show/people-gallery>.

Using LibreOffice on macOS

Some keystrokes and menu items are different on macOS from those used in Windows and Linux. Table 2 below gives some common substitutions for the instructions in this user guide. For a more detailed list, see the application help.

Table 2: Example of macOS keyboard shortcuts

Windows or Linux	macOS equivalent	Effect
Tools > Options on Menu bar	LibreOffice > Preferences on Menu bar	Access to setup options
Right-click	<i>Ctrl</i> +click and/or right-click depending on computer setup	Opens a context menu
<i>Ctrl</i> or <i>Control</i>	⌘ and/or <i>Cmd</i> or <i>Command</i> , depending on keyboard	Used with other keys
<i>Alt</i>	⌥ and/or <i>Alt</i> or <i>Option</i> depending on keyboard	Used with other keys
<i>F11</i>	⌘+T	Open the Styles deck in the Sidebar

Who wrote this user guide?

This user guide was written by volunteers from the LibreOffice community. Profits from sales printed editions are used to benefit the community.

Frequently asked questions

How is LibreOffice licensed?

LibreOffice is distributed under the Open Source Initiative (OSI) approved Mozilla Public License (MPL). See <https://www.libreoffice.org/about-us/licenses/>.

It is based on code from Apache OpenOffice made available under the Apache License 2.0 but also includes software that differs from version to version under a variety of other Open Source licenses. New code is available under LGPL 3.0 and MPL 2.0.

Can LibreOffice be distributed to anyone?

Yes.

Can LibreOffice be sold?

Yes.

Can LibreOffice be used in a business?

Yes.

How many computers can LibreOffice be installed on?

As many as required.

Is LibreOffice available in different languages?

LibreOffice has been translated (localized for more than 80%, both UI and Help) into over 46 languages, so a required language is probably supported. Localization is well under way for another 30+ languages (50-80%) and for another 50+ languages help is more than welcome. In addition, over 70 spelling, hyphenation, and thesaurus dictionaries are available for languages and dialects that do not have a localized program interface. The dictionaries are available from the LibreOffice website at: www.libreoffice.org.

How can LibreOffice be freely available?

LibreOffice is developed and maintained by volunteers and has the backing of several organizations. LibreOffice also relies upon donations from its users. To make a donation, go to the following web page: <https://www.libreoffice.org/donate/>.

Can the programming code from LibreOffice be used when developing a software application?

Yes, but follow the parameters set in the MPL and/or LGPL. Read the licenses: <https://www.mozilla.org/MPL/2.0/>.

Why is Java required to run LibreOffice? Is it written in Java?

LibreOffice is not written in Java; it is written in the C++ language. Java is one of several languages that can be used to extend the software. The Java JDK/JRE is only required for some features. The most notable one is the HSQLDB relational database engine.

Java is available at no cost. More information and download links to the appropriate edition for an operating system can be found at: <https://java.com/en/download/manual.jsp>



Note

If the LibreOffice features that require Java are to be used, it is important that the correct 32-bit or 64-bit edition matches the installed version of LibreOffice. If Java is not to be used, nearly all LibreOffice features can still be used.

How can users contribute to LibreOffice?

Users can help with the development and user support of LibreOffice in many ways, and there is no need to be a programmer. To start, check out this webpage:

<https://www.libreoffice.org/community/get-involved/>. An interactive web page that guides users in contributing with their best skills available at <https://whatcanidoforlibreoffice.org>.

Can the PDF copy of this user guide be distributed, or printed and copies sold?

Yes, as long as requirements are met for one of the licenses in the copyright statement at the beginning of this user guide. There is no need to request special permission.

LibreOffice requests that users share with the LibreOffice project some of the profits made from sales of user guides, in consideration of all the work that LibreOffice volunteers have put into producing user guides.

Donate to LibreOffice: <https://www.libreoffice.org/donate/>.

What is new in LibreOffice 7.5?

The LibreOffice 7.5 Release Notes are available at this link <https://wiki.documentfoundation.org/ReleaseNotes/7.5>.

Also at this link, the release notes for earlier versions of LibreOffice are located giving more information on the features that are included in LibreOffice.

Noticeable improvements or enhancements to this version include the following:

- A new set of application and mime types icons as shown in Figure 3. The icon groups are, from left to right, standard (apps), standard (mime types), macOS specific.
- Support for dark and high contrast operating system themes on Windows, macOS and Linux is improved.
- The Start Center can now filter recent documents by type.

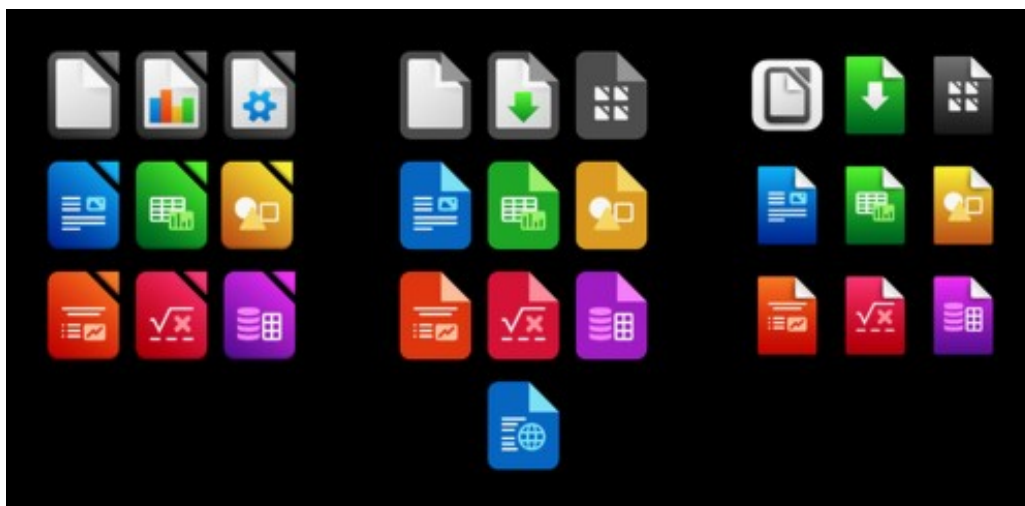

Figure 3: New application icons



LibreOffice
Community



Draw Guide 7.5

Chapter 1, Introducing Draw

Introduction

LibreOffice Draw is a vector graphics drawing program, that can also perform some operations on raster graphics (pixels). Using Draw, a wide variety of graphical images can easily and quickly be created.

Vector graphics store and display an image as an assembly of simple geometric elements such as lines, circles, and polygons, rather than a collection of pixels (points on the screen). Vector graphics allow for easier storage and image scaling.

Draw is fully integrated into the LibreOffice suite simplifying exchanging graphics with all LibreOffice modules. If an image is created in Draw, reusing it in a Writer document is relatively easy. For example, select and copy the drawing in Draw and then paste the image directly into a Writer document. Also, drawings can be worked on directly from within Writer or Impress, using a subset functions and tools from Draw.

The functionality of LibreOffice Draw is extensive. Draw was not designed to rival high-end graphics applications, but possesses more functionality than the drawing tools that are generally integrated with the majority of office productivity suites. A few examples of drawing functions are as follows:

- Layer management
- Magnetic grid-point system
- Dimensions and measurement display
- Connectors for making organization charts and other diagrams
- 3D functions for creating small three-dimensional drawings
- Drawing and page-style integration
- Bézier curves

This Draw Guide is not a course book to be worked through from beginning to end. Rather, it is a reference work in which can be browsed for guidance on particular topics.

This document describes only the functions associated with Draw. Some concepts, such as file management, or the way the LibreOffice environment works, are mentioned only briefly and are covered in more detail in the *Getting Started Guide*.

Draw main window

Pages pane

In Draw, drawings can be split over several pages with multi-page drawings used mainly for presentations. The **Pages** pane, on the left side of the Draw main window, provides an overview pages created in a drawing. If the **Pages** pane is not visible, select **View > Page Pane** on the Menu bar. To make changes to the page order, drag and drop one or more pages displayed in the **Pages** pane.

Workspace

The large area in the center of the Draw main window (Figure 4) is the Workspace where drawings are created. This drawing area can be surrounded with toolbars and information areas. The number and position visible tools vary with the task being carried out, user preferences, and computer setup.

The maximum size of a drawing page in LibreOffice Draw is limited by the computer setup and the page size that that can be set and used in the printer connected to the computer.

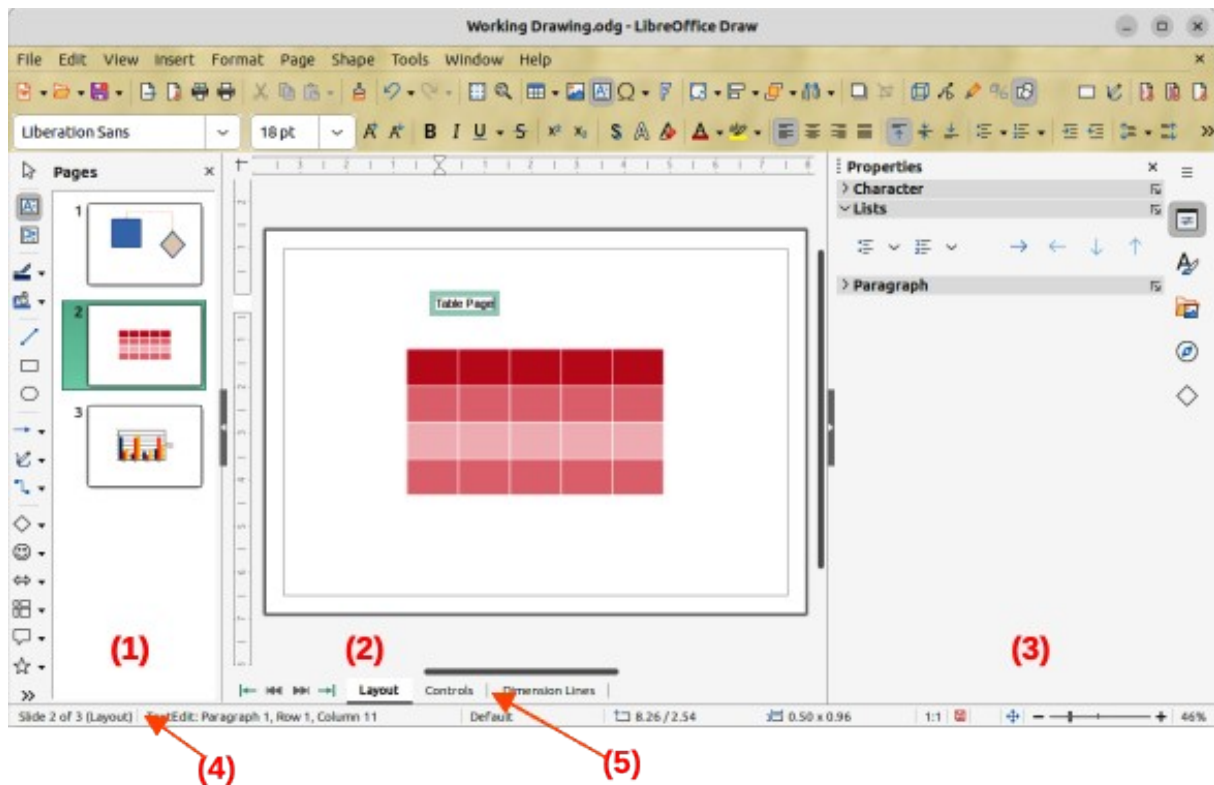

Figure 4: Draw Main Window

- | | |
|---------------|---------------|
| 1) Pages pane | 4) Status bar |
| 2) Workspace | 5) Layers bar |
| 3) Sidebar | |

Sidebar

The Sidebar in Draw has five main decks and is similar to the Sidebar in the other LibreOffice modules. To open a deck, click on its icon on the right of the Sidebar, or click on **Sidebar Settings** at the top of the Sidebar and select a deck from the drop-down list. If the Sidebar is not visible, select **View > Sidebar** on the Menu bar, or use the keyboard shortcut *Ctrl+F5* (macOS *⌘+F5*).

Properties

Contains panels where properties of a selected object in a drawing are changed: **Page**, **Character**, **Paragraph**, **Area**, **Line**, **Effect**, **Shadow**, **Position and Size**, **Columns**, and **Image**. Available panels depend on the selected object.

Styles

Provides options to edit and apply available **Drawing Styles** to objects in a drawing. When a style is edited or modified, changes are automatically applied to all elements formatted using that style. In Draw, **Presentation Styles** are not available. New drawing styles can be added to a drawing.

Gallery

Objects on the Gallery deck are inserted into a drawing either as a copy or as a link. The Gallery is divided into themes: **Arrows**, **BPMN** (Business Process Model and Notation), **Bullets**, **Diagrams**, **Flow chart**, **Icons**, **Network**, **Shapes**, and **Sounds**. New themes are added to the Gallery. See Chapter 11, Advanced Draw Techniques for more information on using the Gallery.

Navigator

On the Navigator deck, pages and objects in a drawing are quickly selected. It is recommended to use meaningful names for pages and objects in a drawing for easy identification and location when using the Navigator.

Shapes

Provides quick selection of some items available on the Drawing toolbar: **Lines and Arrows, Curves and Polygons, Connectors, Basic Shapes, Symbol Shapes, Block Arrows, Flowchart, Callouts, Stars and Banners, and 3D Objects.**

Status bar

The **Status Bar** (Figure 5) is located at the bottom of the **Workspace** in all LibreOffice modules. To hide the **Status Bar**, select **View** on the Menu bar and deselect **Status Bar** from the submenu.

✓ Note

The measurement units shown on the Status Bar are set by going to **Tools > Options > LibreOffice Draw > General** (macOS **LibreOffice > Preferences > LibreOffice > General**) on the Menu bar. These measurement units can be different to the measurement units set for the rulers.

Slide (drawing) number

Shows the drawing pane number that is selected.

Information area

Shows which action is being carried out, or object type selected.

Master drawing

Indicates the master drawing in use.

Cursor position/Selected object size

Shows different information depending on whether objects are selected or not.

- When no object is selected, the position numbers show the current position (X and Y coordinates) of the mouse cursor.
- When an object is selected and being resized with the mouse, the object size numbers show the object size (width and height).

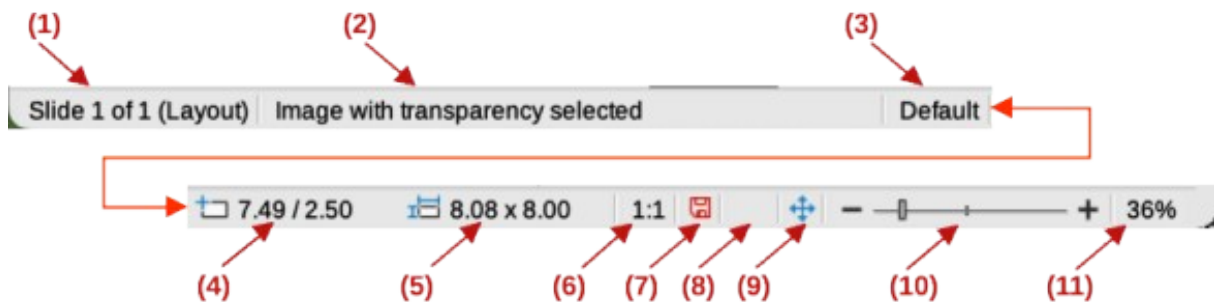

Figure 5: Status Bar

- | | | |
|---------------------------|----------------------------|---------------------|
| 1) Slide (drawing) number | 5) Selected object size | 9) Fit drawing |
| 2) Information area | 6) Document scaling factor | 10) Zoom slider |
| 3) Master drawing | 7) Unsaved changes | 11) Zoom percentage |
| 4) Cursor position | 8) Digital signature | |

- If an object is selected, the position numbers shows the X and Y coordinates of the upper-left corner and the object size number pair displays the object size. These numbers do not relate to the object itself, but to the selection outline, which is the smallest possible rectangle that can contain the visible object part or parts. See Chapter 3, Working with Objects and Object Points for more information.
- When an object is selected, clicking in either of these areas opens the Position and Size dialog. See Chapter 4, Changing Object Attributes for more information.

Scaling factor of the document

Indicates how the drawing appears on the display. The default scaling factor is 1:1. To change the scaling factor, right-click on the scaling factor and select a scaling factor from the context menu that opens.

Unsaved changes

Indicates that the file needs saving. The icon displayed depends on the computer operating system and setup. Clicking on this icon opens the Save as dialog if the file is new and has not been saved before. If the file has been saved already, then clicking on this icon automatically saves the file after any changes have been made.

Digital signature

Indicates if the document is digitally signed. The icon only appears if the drawing has a digital signature certificate. After the file has been saved, double clicking on this icon opens the digital signatures dialog. See LibreOffice Help for more information on digital signature certificates.

Fit drawing

Resizes the drawing so that the whole drawing appears in the Workspace.

Zoom slider and Zoom percentage

Adjusts and indicates the Workspace zoom percentage displayed. Double clicking on zoom percentage opens the Zoom & View Layout dialog.

Layers bar

A layer is a workplace where drawing elements and objects can be inserted. By default, the Workspace consists of three layers (**Layout**, **Controls** and **Dimension Lines**) and the tabs for these default layers appear at the Workspace bottom. The default layers cannot be deleted or renamed, but layers can be added as and when necessary.

Tabs for layers appear in the Layers bar at the Workspace bottom. Use the Layers bar to navigate between layers, add layers as required, or delete layers that have been created. For more information on layers, see Chapter 11, Advanced Draw Techniques.

Rulers

Rulers are positioned on the Workspace upper and left-hand sides. If the rulers are not visible, select **View > Rulers** in the Menu bar, or use the keyboard shortcut *Ctrl+Shift+R* (macOS *⌘+Shift+R*). The rulers show the size of a selected object on the page using double lines (highlighted in Figure 6). Also, rulers are used to manage object handles and guide lines when positioning objects.

The page margins in the drawing area are represented on the rulers. Change the margins directly on the rulers by dragging them with the cursor. The margin areas are normally indicated by a grayed out area on the rulers as shown in Figure 6, but this does depend on computer operating system and setup.

To change the ruler measurement units, right-click on a ruler and select the measurement unit from the drop down list, as shown in Figure 7 for the horizontal ruler. Measurement units for the horizontal and vertical rulers can use different measurement units.

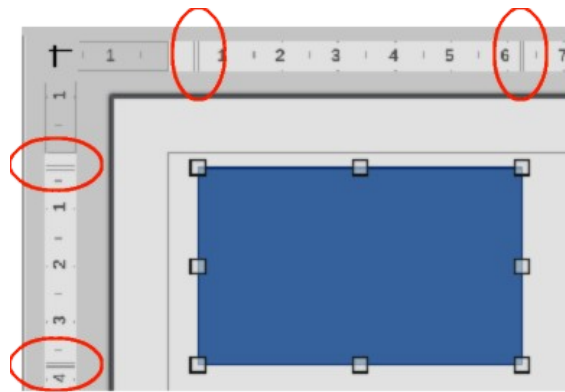

Figure 6: Rulers showing object size

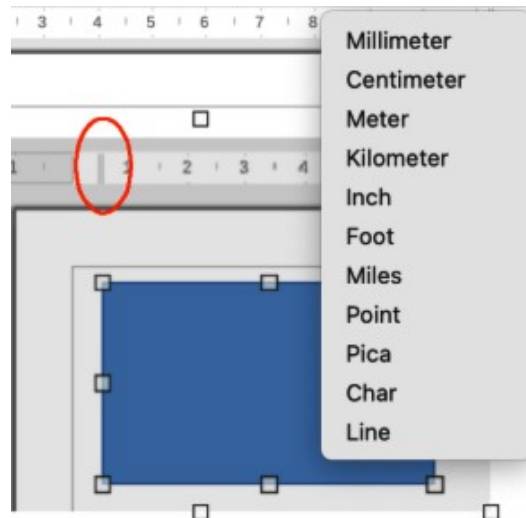

Figure 7: Ruler measurement units

Toolbars

To display or hide the various Draw toolbars, select **View > Toolbars** on the Menu bar and select the toolbar required from the submenu. For example, the Standard and Drawing toolbars are shown by default, but the Line and Filling, Text Formatting, and Options toolbars are not shown.

The appearance of tool icons on toolbars depends on the computer operating system and the selection of icon style and size in **Tools > Options > LibreOffice > View** (macOS **LibreOffice > Preferences > LibreOffice > View**).

The tools available on a toolbar are indicated, either, highlighting around the tool icon, or a check mark as shown by the example in Figure 8. For more information about working with toolbars, see Appendix B, Toolbars and the *Getting Started Guide*.

The four main toolbars used in Draw are as follows:

Standard toolbar

The Standard toolbar (Figure 9) is similar for all LibreOffice components and is not described in detail in this chapter. By default, it is locked into position at the top of the Draw main window.

Drawing toolbar

The Drawing toolbar (Figure 10) contains all the necessary functions for drawing various geometric and freehand shapes, and for organizing them in the drawing. By default, it is locked into position on the left of the Draw main window. It is described in detail in Chapter 2, Drawing Basic Shapes.

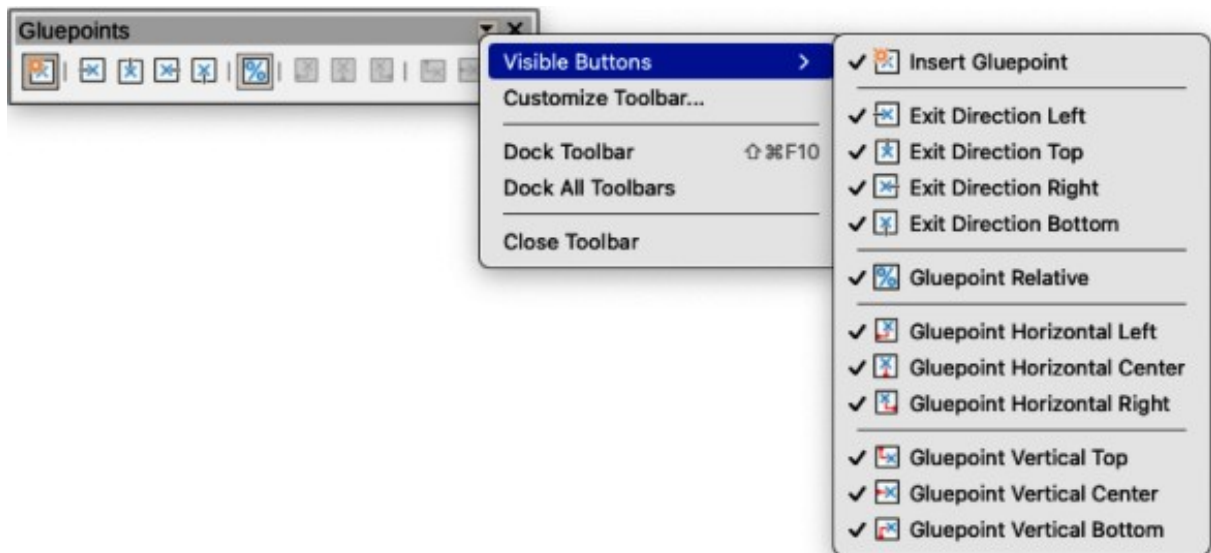

Figure 8: Example of Visible Buttons



Figure 9: Standard toolbar

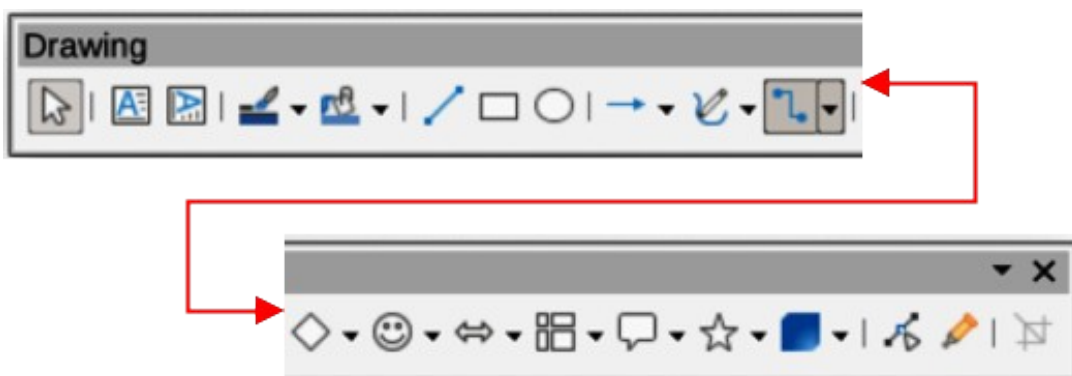

Figure 10: Drawing toolbar

Line and Filling toolbar

The Line and Filling toolbar (Figure 11) is used to modify the main properties of a drawing object. The tools and pull-down lists vary according to the type of object selected. For example, to change the style of a line, click on the up and down arrows for **Line Style** and select the required style.

The functions on the Line and Filling toolbar are used to change the color, style, and width of the line drawn, the fill color and style, and other properties of a selected object. If the selected object is a text frame, the Line and Filling toolbar is replaced by the Text Formatting toolbar. For more information, see Chapter, 4 Changing Object Attributes.

Text Formatting toolbar

The Text Formatting toolbar (Figure 12) is similar to the Formatting toolbar in Writer. It is only available when text, or a text object, has been selected in a drawing, replacing the Line and Filling toolbar. For more information, see Chapter, 4 Changing Object Attributes, and Chapter 9 Adding and Formatting Text.



Figure 11: Line and Filling toolbar

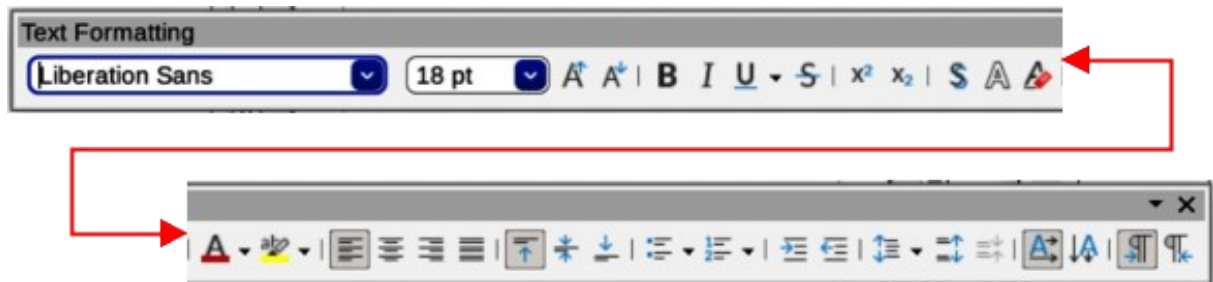

Figure 12: Text Formatting toolbar

Adding and removing tools

The default set of tools on each toolbar can be modified using **Visible Buttons**. Adding or removing a tool is as follows:

- 1) Either, right-click in an empty area on the toolbar, or click on the triangle ▼ in the toolbar title and select **Visible Buttons** from the context menu.
- 2) Click on a tool name in the submenu that opens to add or remove the tool.

✓ Note

For more information on the available tools that can be added to a toolbar, see Appendix B, Toolbars and the *Getting Started Guide*. When a tool is added to a toolbar, its position on the toolbar (from left to right) is the same as its position in the **Visible Buttons** context menu.

Available toolsets

Some tools on a toolbar have a triangle ▼ to the right side of the tool icon indicating that the tool has additional tools available in a sub-toolbar. Clicking on this triangle ▼ displays the full set of available tools (Figure 13).

This palette, or sub-toolbar, can be turned into a floating toolbar. Click the area at the top of the toolset (highlighted in Figure 13) and drag it across the screen to a convenient location, then release the cursor. To close a floating toolbar, click on the **X** on the right of the toolbar title.

i Tip

When double-clicking on a tool, the command corresponding to that tool becomes active and remains active. The tool command can be repeated as often as required. To exit from this mode, press the *Esc* key or click on another tool. Please note that this may not work for every tool on every toolbar.

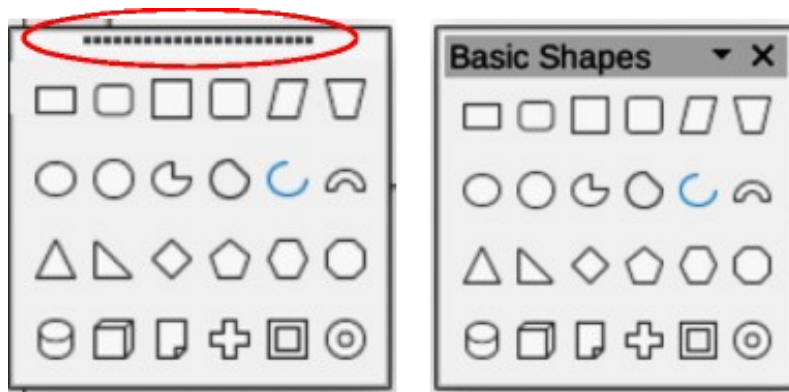

Figure 13: Example of available toolsets



Figure 14: Example of toolbar handles

✓ Note

When a sub-toolbar is made into a floating toolbar, the tool on the existing toolbar remains in the toolbar and always shows the last tool used. This means that the tool icon on a screen may differ from the tool icon shown in this guide.

Unlocking and locking toolbars

By default when Draw is opened, any docked toolbars are locked into position and have to be unlocked before becoming floating toolbars or repositioned on the Draw main window. The locking status of toolbars is indicated by dotted handles at the left end of horizontal toolbars, as shown highlighted in Figure 14. For vertically positioned toolbars, these dotted handles are positioned at the toolbar top.

✓ Notes

Make sure that all toolbars are docked into the required position in the LibreOffice window before using **Lock Toolbars** or **Lock Toolbar Position**.

No dotted handles on toolbars indicates that the toolbars are locked and the following procedures have to be used to unlock toolbars.

All toolbars available in LibreOffice can be locked into position. This overrides any unlocking of individual toolbars. To unlock or lock all the toolbars, use the following procedure:

- 1) Make sure all open LibreOffice documents have been saved.
- 2) To unlock all toolbars, go to **View > Toolbars** on the Menu bar and select **Lock Toolbars** from the context menu.
- 3) Select **Restart Now** from the warning message that opens and all toolbars can now be individually unlocked. Toolbar handles now appear on individual toolbars that are not locked.
- 4) To lock all toolbars, go to **View > Toolbars** on the Menu bar and select **Lock Toolbars** from the context menu.

- 5) Select **Restart Now** from the warning message that opens and all toolbars are now locked into position. Toolbar handles are no longer displayed.

Individual toolbars can be unlocked or locked using the following procedure:

- 1) To unlock a toolbar, right-click in a blank area on the toolbar and select **Lock Toolbar Position** from the context menu. A toolbar handle appears at the end of the toolbar, indicating that the toolbar is unlocked and can be moved.
- 2) To lock a toolbar into position, dock the toolbar into position, then right-click in a blank area on the toolbar and select **Lock Toolbar Position** from the context menu. The toolbar handle disappears from the end of the toolbar.

Note

There is no selection indication on Lock Toolbars, or Lock Toolbar Position in the context menus. The locking indication is only indicated by the toolbar handles.

Undocking toolbars

When Draw is opened, the Standard and Drawing toolbars, by default, are already docked into their positions on the main Draw window. These toolbars can be undocked creating floating toolbars as follows:

- 1) Make sure the toolbar handle is displayed indicating that the toolbar is unlocked. If there is no toolbar handle displayed, see “Unlocking and locking toolbars” on page 25 for more information.
- 2) Move the cursor to the far left of the toolbar and over the toolbar handle. The cursor changes shape, normally to a grabbing hand, depending on computer setup and operating system.
- 3) Click and drag on the toolbar handle and move the toolbar until it is undocked and becomes a floating toolbar. This floating toolbar capability is common to all components of LibreOffice.

Docking toolbars

To dock a floating toolbar use one of the following methods:

- Press and hold the *Ctrl* key (macOS ⌘), then double click on the toolbar title. The toolbar moves into available space at the top of the Draw main window.
- Click in the toolbar title and drag the toolbar to the docked position required. This can be the top, bottom or one of the sides of the Draw main window.

Customizing toolbars

Draw toolbars can be customized by adding or removing commands to or from a toolbar. Also, customization allows the creation of toolbars for specific purposes. Customizing toolbars is in addition to using “Adding and removing tools” on page 24. For more information on adding new commands, modifying toolbars, or creating toolbars, see Appendix B, Toolbars and the *Getting Started Guide*.

Choosing and defining colors

Color palette

The Color Palette (Figure 15) provides quick access to a standard set of colors to use for selected objects and text in a drawing.



Figure 15: Color Palette (Color Bar)

- 1) Go to **View** on the Menu bar and select **Color Bar** to open the Color Palette.
- 2) Select an object or text.
- 3) Left click on the color required for the area fill, or text, and change the color of the object or text.
- 4) Right click on the color required for the object, or text box border, and change the border color.
- 5) Go to **View** on the Menu bar and deselect **Color Bar** to close the Color Palette.

✓ Note

The box with the X at the bottom left of the Color Palette corresponds to none (no color).

Specialized color palettes

In addition to the standard Color Palette, Draw has several specialized color palettes available, giving a greater choice of color: for example, chart-palettes, material, html, and so on. After selecting an object or text in a drawing, use one of the following to access the specialized color palettes.

- Area or fill color — **Color** page in the Area dialog, **Fill Color** on the Drawing or Line and Filling toolbar, or *Fill* in the **Area** section in the Properties deck on the Sidebar.
- Line color — **Line** page in the Line dialog, **Line Color** on the Drawing or Line and Filling toolbar, or *Color* in the **Line** section in the Properties deck on the Sidebar.
- Text color — **Font Color** tool on the Text Formatting toolbar, or *Font Color* in the **Character** section in the Properties deck on the Sidebar.

For more information on selecting a color and a color palette for an object or text, see Chapter 4, Changing Object Attributes, Chapter 9, Adding and Formatting Text, and Chapter 11, Advanced Draw Techniques.

Custom colors

In Draw, custom colors can be created using the Color Picker dialog, CMYK values, or RGB values to match specific color schemes used, for example, by a company. For more detailed information on creating custom colors and color palettes, as well as more information on CMYK and RGB color schemes, refer to Chapter 11, Advanced Draw Techniques.

Grid, snap guides, and helplines

The grid, snap guides, and helplines in Draw act as drawing aids when moving and positioning objects in a drawing. These drawing aids can be turned on or off as follows:

- Line and Filling toolbar — click on **Display Grid**, or **Helplines While Moving** to turn the grid or helplines on or off.
- Options toolbar — click on **Display Grid**, **Display Snap Guides**, or **Helplines While Moving** to turn the grid, snap guides, or helplines on or off.
- Go to **View > Grid and Helplines** on the Menu bar and select, or deselect **Display Grid**, or **Helplines While Moving** on the submenu.
- Go to **View > Snap Guides** on the Menu bar and select, or deselect **Display Snap Guides** on the submenu.

The grid and snap guides are displayed only on the screen and are not shown on a printed drawing, or when the drawing is used in another LibreOffice module. The color, spacing and resolution of the grid points can be individually chosen for each axis. Draw also offers several snap functions to position objects exactly in a drawing.

Helplines show the object position while moving and makes positioning an object much easier. If this function is activated, pairs of vertical and horizontal lines enclosing the object are shown while moving the object. These helplines extend to the drawing area edges.

For more information on the grid, snap guides, snap functions, and helplines, see Chapter 3, Working with Objects and Object Points.



LibreOffice
Community



Draw Guide 7.5

Chapter 2, Drawing Basic Shapes

Introduction

LibreOffice Draw can create 2D and 3D objects and this chapter explains how to draw simple 2D objects. The following chapters in this user guide describe how to work with and edit 2D objects. For more information on 3D objects, see Chapter 7, Working with 3D Objects.

All shapes, such as lines, rectangles, and shapes are called objects. This is common notation in vector drawing software.

Frequently used drawing tools are found on the Drawing toolbar (Figure 16) and this toolbar is normally docked on the left side of the main Draw window. If the toolbar is not visible, go to **View > Toolbars** on the Menu bar and select **Drawing** from the available options.

The Drawing toolbar can be unlocked and placed in the Draw workspace as a floating toolbar. Toolbars can be configured by adding, moving, hiding, or deleting tools. See Chapter 1, Introducing Draw for more information.

When a shape is drawn, an object selected for editing, or text added to the drawing, the information field in the **Status Bar** (Figure 17) changes to reflect the action taken or in progress. See Chapter 1, Introducing Draw for more information on the **Status Bar**.

Drawing basic shapes

Basic shapes, including text, are treated as objects in Draw. The default set of tools available for drawing basic shapes on the Drawing toolbar are shown in Figure 16. To add more tools to the Drawing toolbar, see Appendix B, Toolbars and the *Getting Started Guide* for more information.

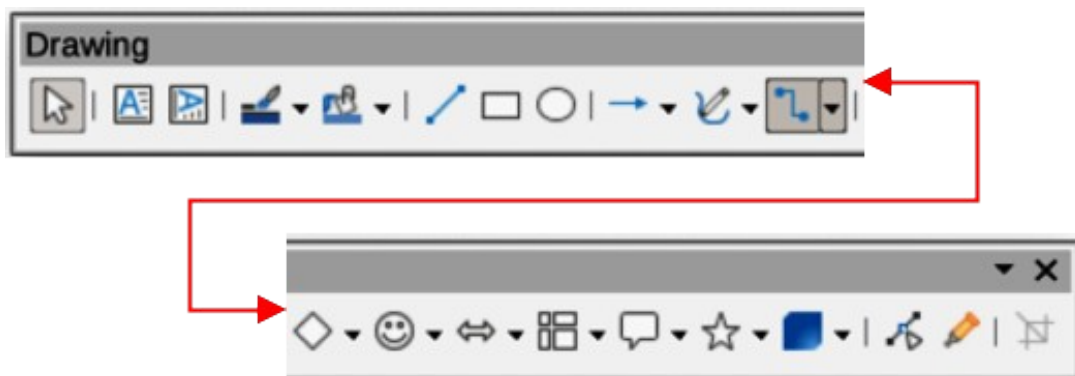

Figure 16: Drawing toolbar

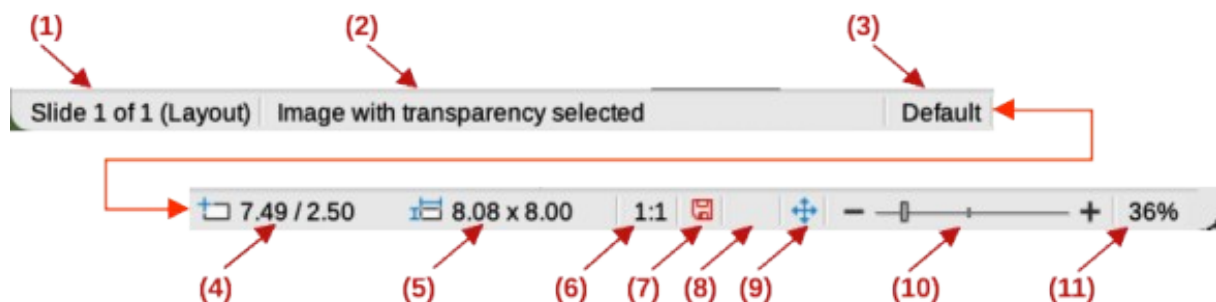

Figure 17: Status Bar

- | | | |
|---------------------------|----------------------------|---------------------|
| 1) Slide (drawing) number | 5) Selected object size | 9) Fit drawing |
| 2) Information area | 6) Scaling document factor | 10) Zoom slider |
| 3) Master drawing | 7) Unsaved changes | 11) Zoom percentage |
| 4) Cursor position | 8) Digital signature | |

Some tool icons on the Drawing toolbar change shape according to the last tool used from the selection of available tools. Each tool that has a triangle ▼ next to the tool icon indicates that more tools are available. See “Drawing geometric shapes” on page 42 for information on the available shapes.

✓ Note

When a basic shape is drawn, or one selected for editing, the information area at the left side in the **Status Bar** changes to reflect the present action. For example *Line created*, *Text frame xxyy selected*, and so on.

Straight lines

Creating lines

A straight line is the simplest element or object in Draw to create.

- 1) Use one of the following options to draw a straight line:
 - Click **Insert Line** on the Drawing toolbar.
 - Click on the triangle ▼ next to **Lines and Arrows** on the Drawing toolbar and select **Insert Line** from the options available.
 - Click **Insert Line** in the **Line and Arrows** panel of the Shapes deck on the Sidebar (Figure 18).
- 2) Place the cursor at the starting point on the drawing, then click and drag the cursor to draw a straight line.
- 3) Release when the end point is reached and a straight line is created. A selection handle appears at each line end. The selection handle at the starting point of a line is slightly larger than the selection handle at the end point (highlighted in Figure 19).
- 4) To snap the end of a straight line to the nearest grid point, hold down the *Ctrl* (macOS ⌘) key while drawing the straight line. This is the default behavior of the *Ctrl* key (macOS ⌘).
- 5) To restrict the drawing angle of a straight line to multiples of 45 degrees (0, 45, 90, 135, and so on), hold down the *Shift* key while drawing a straight line. This is the default behavior of the *Shift* key.

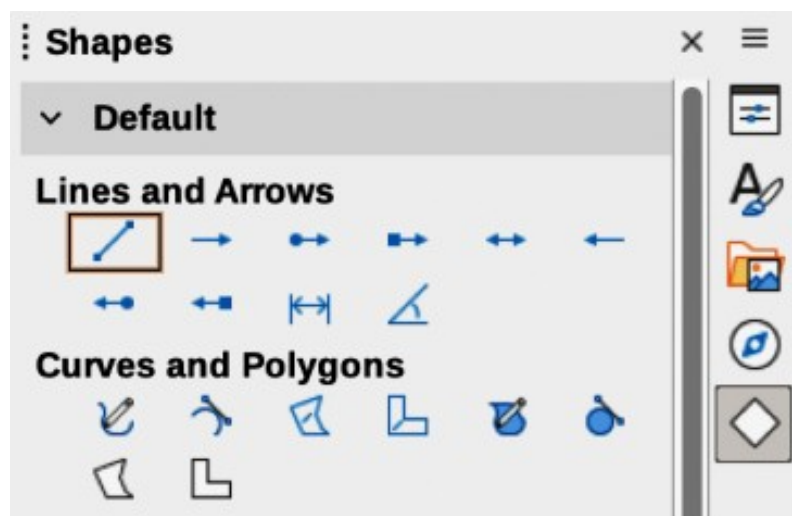

Figure 18: Lines and Arrows panel in Shapes deck on Sidebar

- 6) To draw a straight line symmetrically outwards in both directions from the start point, hold down the *Alt* (macOS \backslash) key to a straight line from the middle.

✓ Notes

If the option **View > Snap Guides > Snap to Grid** on the Menu bar has been selected, holding down the *Ctrl* (macOS ⌘) key while drawing a straight line temporarily deactivates the **Snap to Grid** option.

If the option **When creating or moving objects** in the *Constrain Objects* section of **Tools > Options > LibreOffice Draw > Grid** (macOS **LibreOffice > Preferences > LibreOffice Draw > Grid**) has been selected, holding down the *Shift* key temporarily deactivates this restriction.

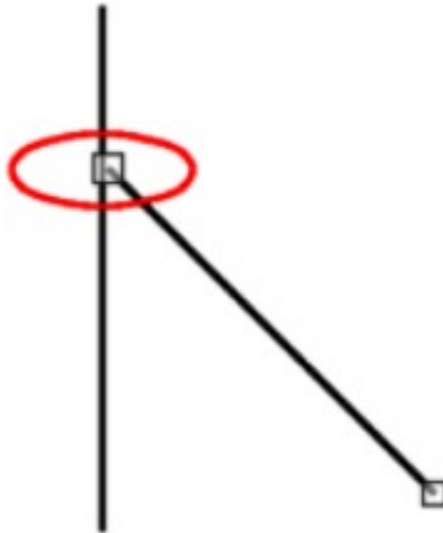

Figure 19: Line starting point highlighted

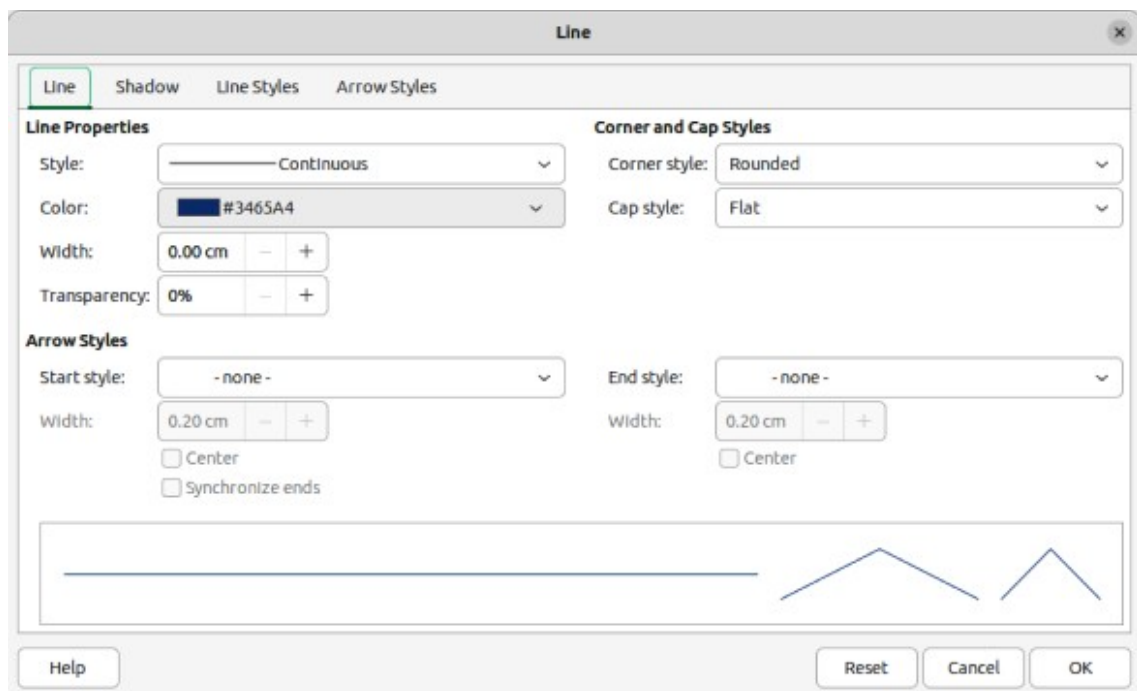

Figure 20: Line dialog — Line page

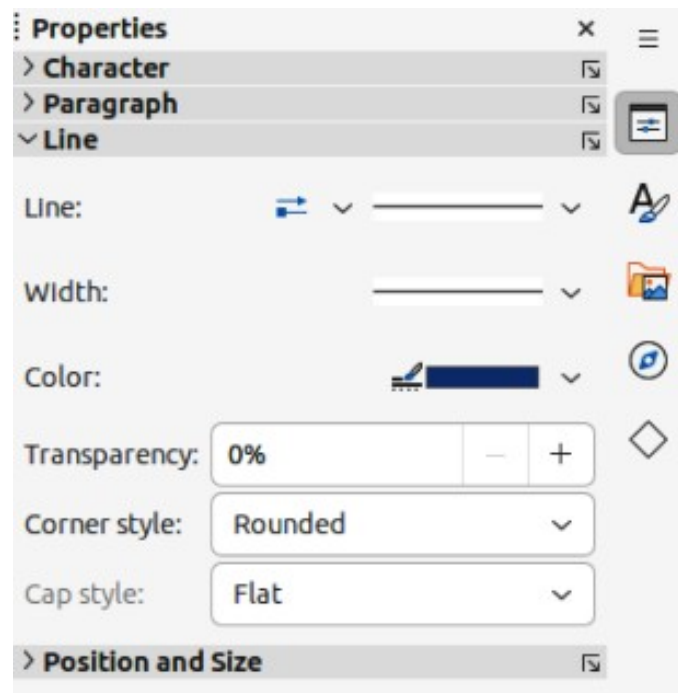

Figure 21: Line panel in Properties deck on Sidebar

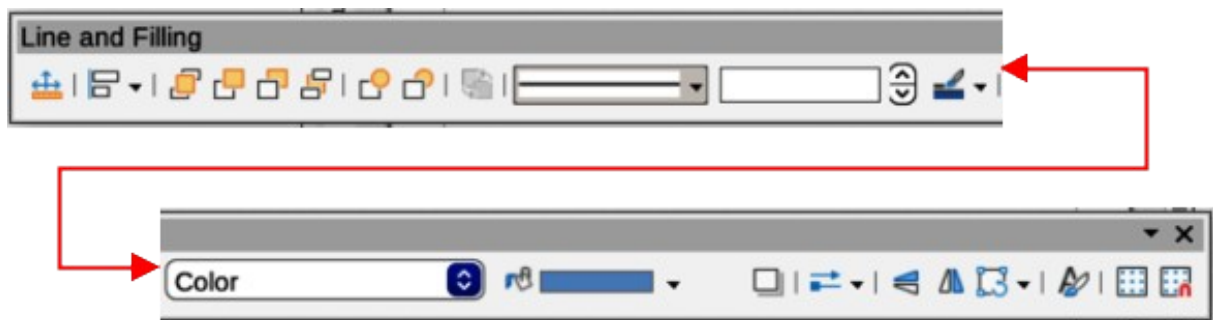

Figure 22: Line and Filling toolbar

Formatting lines

When a line is drawn, it uses default attributes for line style, line color, line width and transparency. To change any of these attributes to the drawing requirements is as follows:

- 1) Select the straight line by clicking on it to display the selection handles.
- 2) Format the line style, line color, line width, or transparency from the options available using one of the following methods:
 - Go to **Format > Line** on the Menu bar to open the Line dialog (Figure 20).
 - Right-click on the line and select **Line** from the submenu to open the Line dialog.
 - Open the **Line** panel in the Properties deck on the Sidebar (Figure 21).
 - Use the tools **Line Style**, **Line Width**, and **Line Color** on the Line and Filling toolbar (Figure 22).
- 3) Click on a line selection handle and drag the selection handle to increase or decrease the line length.

Lines and arrows

Draw classifies both lines and arrows as lines and are drawn like straight lines (for more information, see “Straight lines” on page 31). Hovering the cursor over each tool in the Lines and Arrows sub-toolbar (Figure 23), or the **Line and Arrows** panel in the Shapes deck on the Sidebar, indicates what type of line or arrow each tool draws. The information field on the **Status Bar** shows them only as lines.



Figure 23: Lines and Arrows sub-toolbar

Legend for Figure 23 numbered from left to right as follows:

- | | | |
|---------------------------|---------------------------|-------------------|
| 1) Insert Line | 5) Line with Arrows | 9) Dimension Line |
| 2) Line Ends with Arrow | 6) Line Starts with Arrow | 10) Line (45°) |
| 3) Line with Circle/Arrow | 7) Line with Arrow/Circle | |
| 4) Line with Square/Arrow | 8) Line with Arrow/Square | |

Creating lines or arrows

✓ Note

The tool icon for the last tool used on a sub-toolbar is already selected on the Drawing toolbar. This makes it easier to use the same tool again.

- 1) Use one of the following methods to draw a line or arrow:
 - Click on the triangle ▼ next to **Lines and Arrows** on the Drawing toolbar and select the type of line or arrow required from the options in the Lines and Arrows sub-toolbar (Figure 23).
 - Select the type of line or arrow required in the **Lines and Arrows** panel of the Shapes deck on the Sidebar (Figure 18 on page 31).
- 2) Place the cursor at the starting point for the line or arrow, then click and drag the cursor. The arrowheads are drawn at the line ends when the line is completed.
- 3) For more information on how to draw lines and arrows, see “Straight lines” on page 31.

Formatting lines or arrows

After drawing a line or arrow, make sure it is selected and format the line or arrow to the drawing requirements using one of the following methods:

- 1) To format the line used for an arrow, see “Straight lines” on page 31 for more information.
- 2) To format an arrow using the same arrowhead style for both arrow ends:
 - a) Select the arrow so that the selection handles are displayed.
 - b) Go to **Format > Line** on the Menu bar or right-click on the arrow to open the Line dialog.
 - c) Click on **Arrow Styles** to open the **Arrow Styles** page (Figure 24) and select an arrow style from the options available in the *Arrow style* drop-down list.
 - d) Click **OK** to apply the arrow style and close the Line dialog.
 - e) Click in an empty space on the drawing to deselect the arrow.

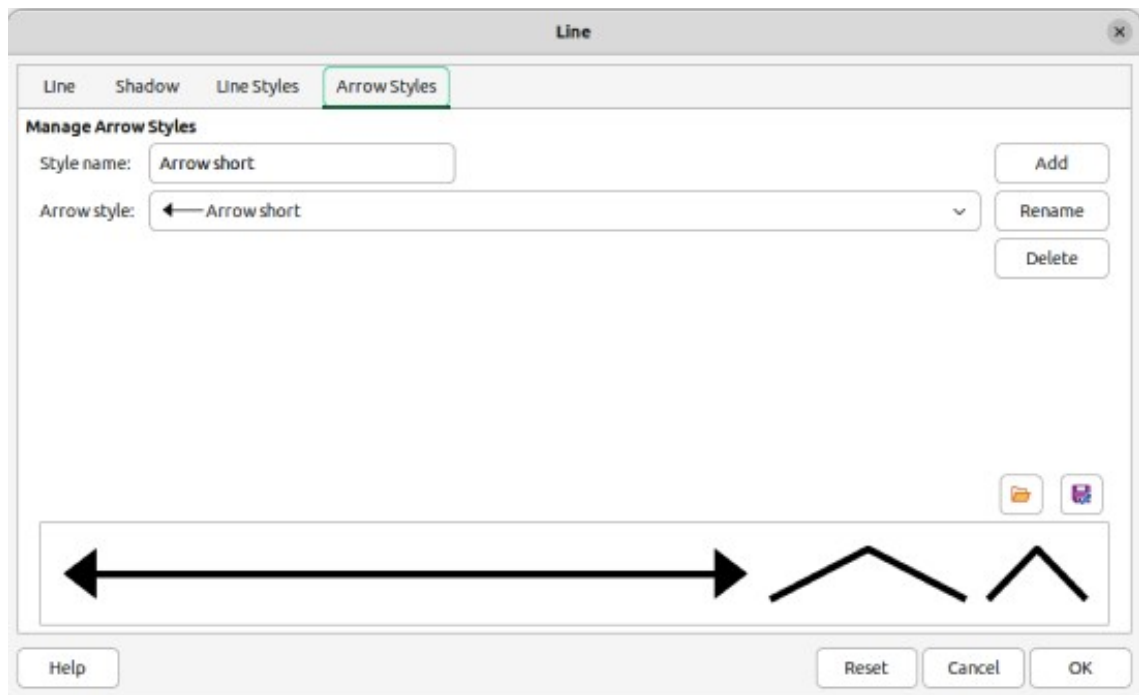

Figure 24: Line dialog — Arrow Styles page

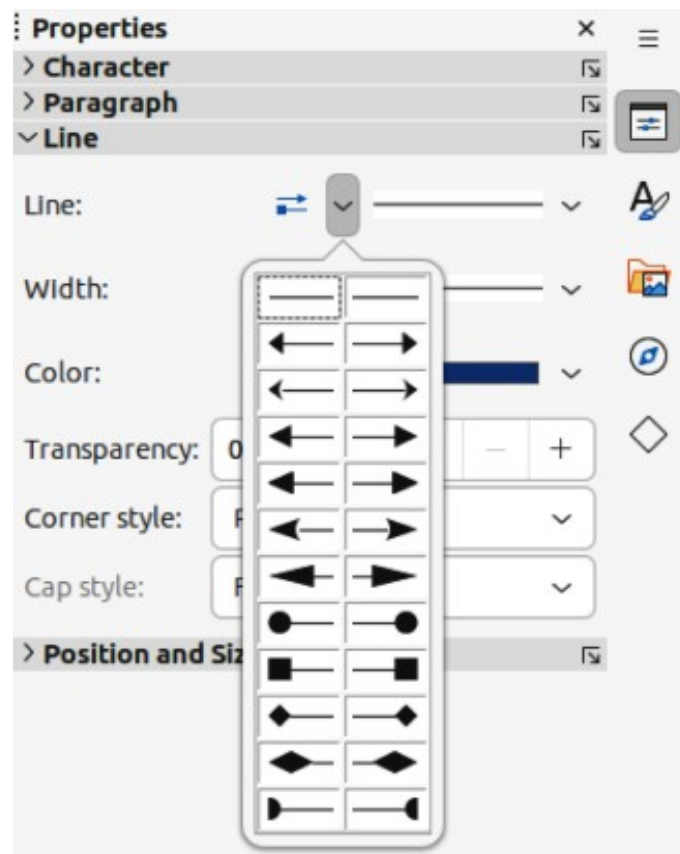

Figure 25: Arrowhead styles in Line panel on Properties deck in Sidebar

- 3) To format an arrow using different arrowhead styles for each arrow end:
 - a) Select the arrow so that the selection handles are displayed.
 - b) Open the **Line** panel on the Properties deck of the Sidebar (Figure 25).

- c) In *Line*, click on **Arrow Style** to open the drop-down list for arrowhead styles.
- d) Select an arrowhead style from the left-hand list of arrowhead styles for the arrow start point.
- e) Select an arrowhead style from the right-hand list of arrowhead styles for the arrow end point.
- f) Click in an empty space on the drawing to deselect the arrow.

Rectangles or squares

- 1) Use one of the following methods to start drawing a rectangle or square:
 - Click on **Rectangle** on the Drawing toolbar.
 - Select the type of rectangle or square in the **Basic Shapes** panel in the Shapes deck on the Sidebar (Figure 26).

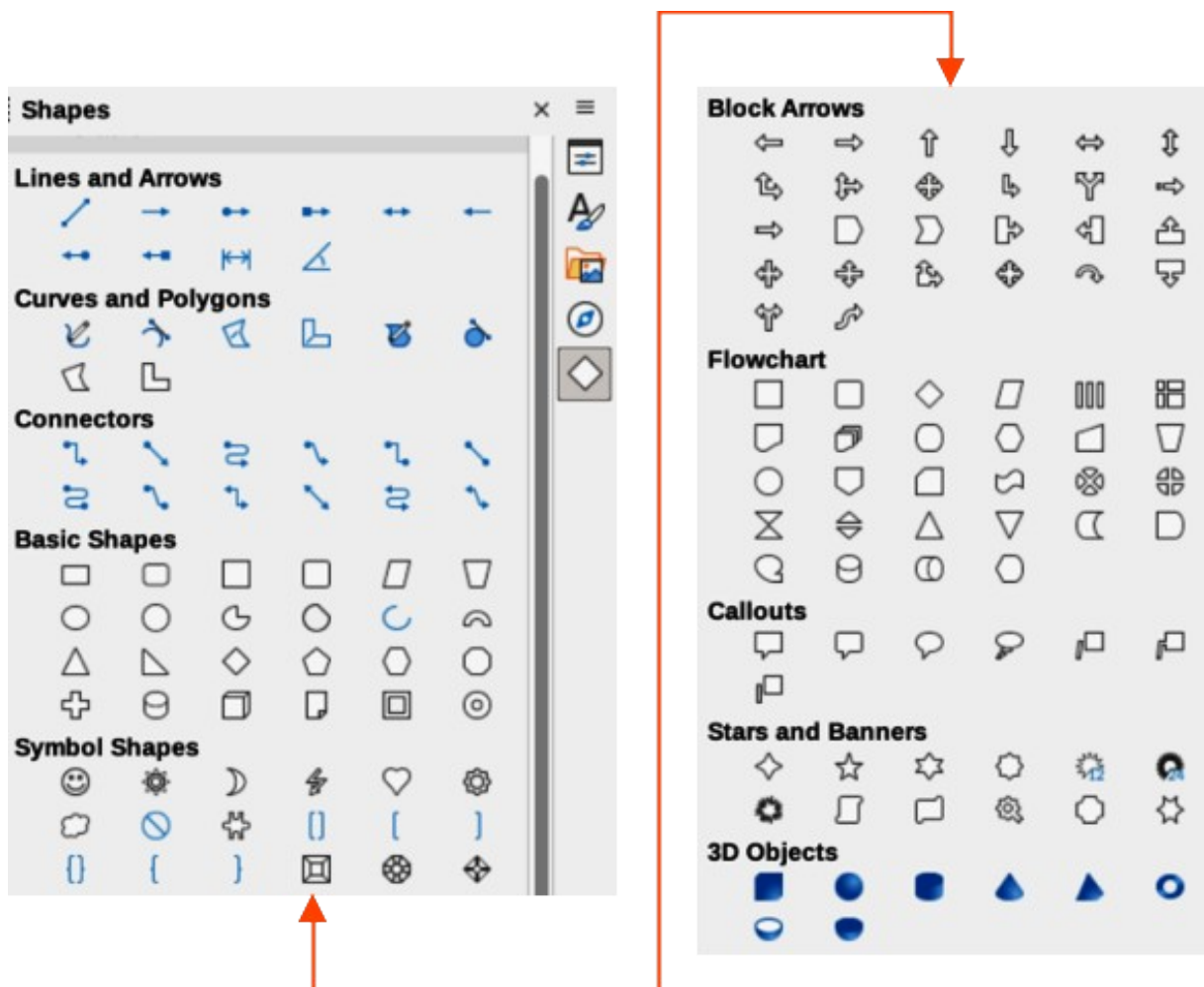

Figure 26: Shapes deck on Sidebar



Figure 27: Legacy Rectangles toolbar

- Click on the triangle ▼ next to **Basic Shapes** on the Drawing toolbar and select the type of rectangle or square required from the drop-down list.
 - Select the type of rectangle or square on the Legacy Rectangles toolbar (Figure 27). To display the Legacy Rectangles toolbar, go to **View > Toolbars** on the Menu bar and select it.
- 2) Place the cursor at the starting point for the rectangle or square, then click and drag the cursor until the required size is drawn. The rectangle or square is drawn from the starting point using the bottom right corner as the anchor point for the cursor.
 - 3) If necessary, use one of the following options to draw a rectangle or square:
 - If a rectangle option is selected, hold down the *Shift* key while dragging the cursor to draw a square.
 - If a rectangle option is selected, hold down the *Alt* key while dragging the cursor to draw a rectangle from its center.
 - If a rectangle option is selected, hold down the *Shift* and *Alt* keys while dragging the cursor to draw a square from its center.
 - If a square option is selected, hold down the *Shift* key while dragging the cursor to draw a rectangle.
 - If a square option is selected, hold down the *Alt* key while dragging the cursor to draw a square from its center.

✓ Note

If the option *When creating or moving objects* has been selected in the **Constrain Object** section of **Tools > Options > LibreOffice Draw > Grid** (macOS **LibreOffice > Preferences > LibreOffice Draw > Grid**), the action of the *Shift* key reversed. A square is drawn instead of a rectangle. To draw a rectangle, hold down the *Shift* key. This reversal of *Shift* key action also applies when drawing ellipses, circles, arcs, and segments.

Ellipses or circles

- 1) Use one of the following methods to start drawing an ellipse or circle:
 - Click on **Ellipse** on the Drawing toolbar.
 - Select the type of ellipse or circle in the **Basic Shapes** panel in the Shapes deck on the Sidebar.
 - Click on the triangle ▼ next to **Basic Shapes** on the Drawing toolbar and select the type of ellipse or circle required from the drop-down list.
 - Select the type of ellipse or circle on the Legacy Circles and Ovals toolbar (Figure 28). To display the Legacy Circles and Ovals toolbar, go to **View > Toolbars** on the Menu bar and select it.

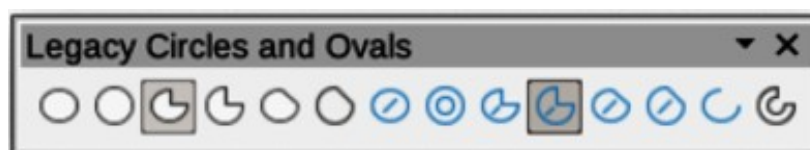

Figure 28: Legacy Circles and Ovals toolbar

- 2) Place the cursor at the starting point for the ellipse or circle, then click and drag the cursor until the required size is drawn. The ellipse or circle is drawn from the starting point using the bottom right corner as the anchor point for the cursor.
- 3) If necessary, use one of the following options while drawing an ellipse or circle:
 - If an ellipse option is selected, hold down the *Shift* key while dragging the cursor to draw a circle.
 - If an ellipse option is selected, hold down the *Alt* key while dragging the cursor to draw an ellipse from its center.
 - If an ellipse option is selected, hold down the *Shift* and *Alt* keys while dragging the cursor to draw a circle from its center.
 - If a circle option is selected, hold down the *Shift* key while dragging the cursor to draw an ellipse.
 - If a circle option is selected, hold down the *Alt* key while dragging the cursor to draw a circle from its center.

Tip

To quickly insert a line, rectangle, ellipse, or text, press and hold down the *Ctrl* (macOS ⌘) key and then click on **Line**, **Rectangle**, **Ellipse**, or **Text** and a standard sized object is drawn automatically in the Workspace. The size, shape, and color are all standard values. These attributes can be changed later, if desired. See Chapter 4, Changing Object Attributes for more information.

Dimension lines

Dimension lines display a measurement of an object in the drawing (Figure 29). A dimension line does not belong to the object itself, but is positioned close to it. An object can have as many dimension lines as necessary to indicate the size of its sides, edges, and distances.

To format the display of a dimension line and its components, right-click on the dimension line and selecting **Dimensions** from the context menu to open the Dimension line dialog (Figure 30).

Inserting dimension lines

- 1) Use one of the following options to start drawing a dimension line:
 - Click on the triangle ▼ next to **Lines and Arrows** on the Drawing toolbar and select **Dimension Line** from the drop-down list.



Figure 29: Example of dimension lines for an object

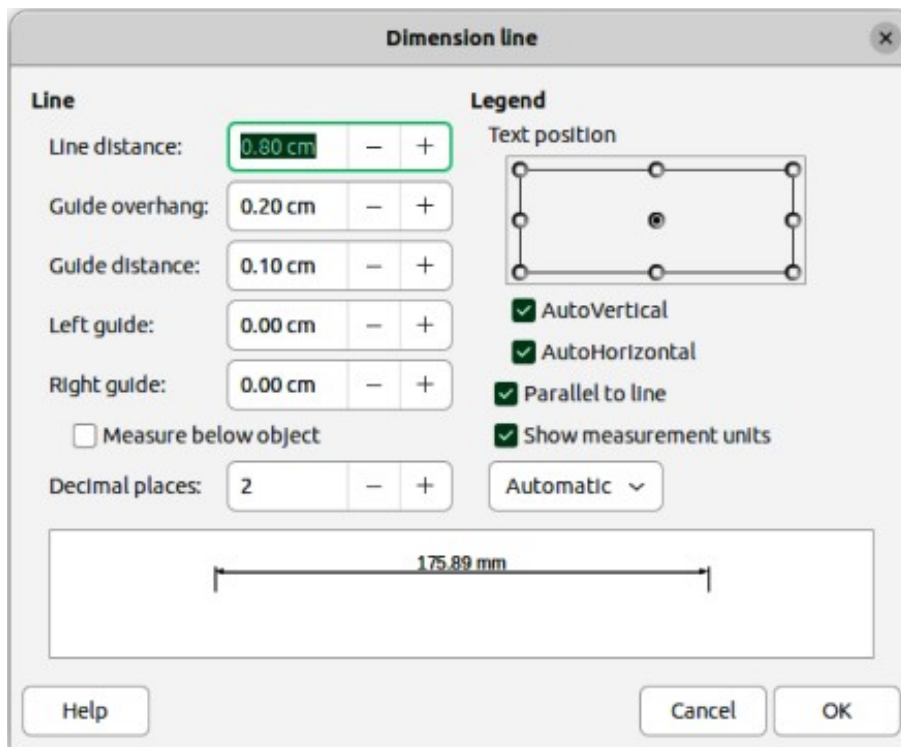

Figure 30: Dimension Line dialog

- Click on **Dimension Line** in the **Lines and Arrows** panel of the Shapes deck on the Sidebar.
- 2) Place the cursor at the point close to the object to position the dimension line start.
 - 3) Click and drag to draw the dimension line. As the dimension line is drawn, the dimension is displayed and automatically calculated.
 - 4) Select the dimension line, then right-click on the dimension line and select **Dimensions** from the context menu to open the Dimension Line dialog.
 - 5) Format the dimension line using the options available in the Dimension Line dialog. For more information dimension line options, see Chapter 11, Advanced Draw Techniques.
 - 6) Click **OK** to save the changes and close the Dimension Line dialog.
 - 7) Click in an empty space on the drawing to deselect the dimension line.

✓ Note

The measurement units used for dimension lines can be changed by going to **Tools > Options > LibreOffice Draw > Grid** on the Menu bar and select a measurement unit from the available options in the *Units of measurement* drop-down list.

Arcs and segments

- 1) Use one of the following methods to start drawing an arc or segment (partial circles or ellipses):
 - Select the type of arc or segment in the **Basic Shapes** panel in the Shapes deck on the Sidebar.
 - Click on the triangle ▼ next to **Basic Shapes** on the Drawing toolbar and select the type of arc or segment required from the drop-down list.

- Select the type of arc or segment from the Legacy Circles and Ovals toolbar. To display the Legacy Circles and Ovals toolbar, go to **View > Toolbars** on the Menu bar and select it.
- 2) Click, hold and drag the cursor to start creating an arc or segment. Release when the required object size is reached.
 - 3) Move the cursor to the position where the arc or segment starts and click to start drawing the arc or segment. The **Status Bar** indicates the angle in degrees.
 - 4) Move the cursor to the end position of where the arc or segment finishes. The **Status Bar** shows the angle in degrees.
 - 5) Click again to complete the arc or segment.

Curves, polygons or freeform lines

Curves

- 1) Select the type of curve required using one of the following methods:
 - Click on the triangle ▼ next to **Curves and Polygons** on the Drawing toolbar and select the type of curve from the drop-down list.
 - Select the type of curve in the **Curve and Polygons** panel of the Shapes deck on the Sidebar.
- 2) Click, hold and drag the cursor from the starting point to draw a line.
- 3) Release and continue to drag the cursor to bend the line into the required curve shape.
- 4) Click to set the curve and position end point of the curve on the drawing.
- 5) Continue dragging the cursor to draw straight lines at the curve end. Each click sets a corner point and allows drawing of another straight line from each corner point.
- 6) Double-click to end the drawing of a curve and straight lines.



Note

A filled curve automatically joins the last point to the first point to close off the object and fills it with the selected fill. A curve without filling is not closed at the end of the drawing.

Polygons

- 1) Select the type of polygon required using one of the following methods:
 - Click on the triangle ▼ next to **Curves and Polygons** on the Drawing toolbar and select the type of polygon from the drop-down list.
 - Select the type of polygon in the **Curve and Polygons** panel of the Shapes deck on the Sidebar.
- 2) Click, hold and drag the cursor to draw a line between the first and second corner points.
- 3) Click again to end the drawing between the first and second corner points of the polygon.
- 4) Move the cursor to draw the next line and click to finish drawing to the next corner point. Each click sets a corner point and draws another line.
- 5) Double-click to end the drawing of a polygon.

✓ Note

A filled polygon automatically joins the last corner point to the first corner point to close off the figure and fills it with the selected fill. A polygon without filling is not closed at the end of the drawing.

Polygons 45°

Like ordinary polygons, these are formed from lines, but the angles between lines are restricted to 45 or 90 degrees. If required, hold down the *Shift* key as the line is drawn so that the line is drawn at an angle other than 45 or 90 degrees.

Freeform lines

Using freeform line tools is similar to drawing with a pencil on paper.

- 1) Click, hold and drag the cursor to the line shape required, then release to complete the freeform line drawing.
- 2) If **Freeform Line Filled** is selected, the end point is joined automatically to the start point and the object is filled with the selected fill.

✓ Note

The points in curves, polygons and freeform lines can be moved and edited. See Chapter 3, Working with Objects and Chapter 11, Advanced Draw Techniques for more information.

Gluepoints and connectors

Gluepoints

All Draw objects have gluepoints, which are not normally displayed, and only become visible when **Connectors** is selected on the Drawing toolbar, or a connector tool is selected in the **Connectors** panel on the Shapes deck in the Sidebar.

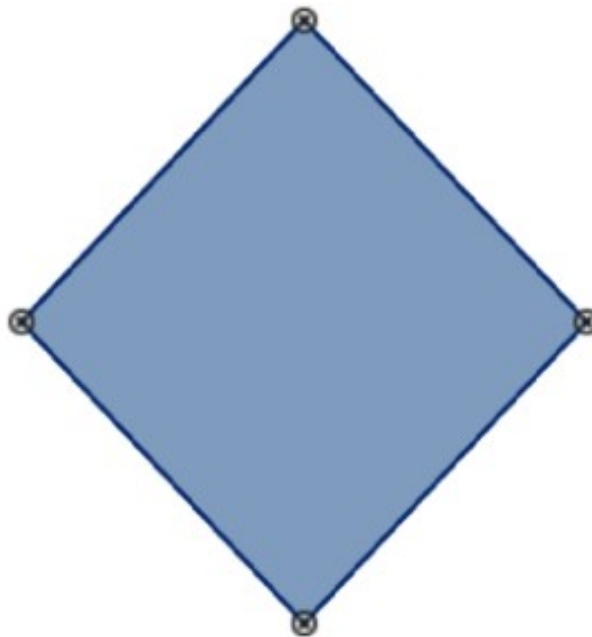

Figure 31: Example of gluepoints in an object

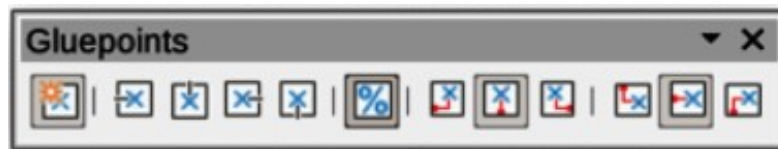

Figure 32: Gluepoints toolbar

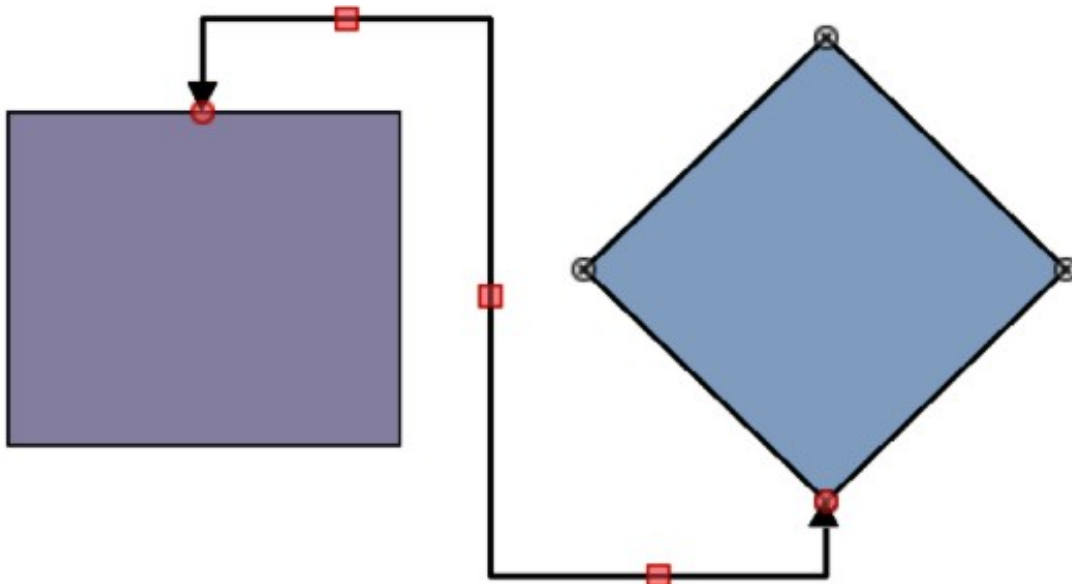

Figure 33: Example of a connector between two objects

Most objects have four gluepoints, as shown in the example in Figure 31. More gluepoints can be added and customized using the Gluepoints toolbar (Figure 32). Go to **View > Toolbars > Gluepoints** on the Menu bar to open the toolbar.

Gluepoints are not the same as the selection handles of an object. Selection handles are for moving or changing the shape of an object. Gluepoints are used to fix or glue a connector to an object so that when the object moves, the connector stays fixed to the object. For a more detailed description on the use of gluepoints, see Chapter 3, Working with Objects and Object Points and Chapter 8, Connections, Flowcharts, and Organization Charts.

Connectors

Connectors are lines or arrows whose ends automatically snap to a gluepoint of an object. Connectors are not the same as lines and arrows. When objects are moved or reordered, the connectors remain attached to a gluepoint. Figure 33 shows an example of two objects and a connector.

Draw offers a range of different connectors and connector functions. On the Drawing toolbar, click on the triangle ▼ next to Connectors and select a connector type from the drop-down list, or select a connector from the **Connectors** panel in the Shapes deck on the Sidebar. For a more detailed description using connectors, see Chapter 8, Connections, Flowcharts, and Organization Charts.

Drawing geometric shapes

The tools for drawing geometric shapes are located on the Drawing toolbar and the Shapes deck in the Sidebar. The use of these tools for geometric shapes is similar to the tools used for drawing rectangles and squares, or ellipses and circles. For more information, see “Drawing basic shapes” on page 30.

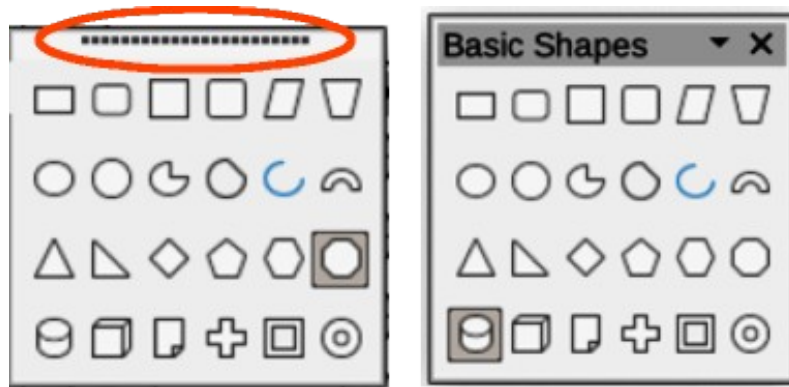

Figure 34: Example of creating a floating sub-toolbar

Clicking on the triangle ▼ to the right of a tool icon on the Drawing toolbar opens a drop-down list giving access to the toolset for that shape. If necessary, this drop-down list can be “torn off” to create a floating sub-toolbar.

- Click and hold on the dotted line at the toolset top (highlighted in Figure 34), then drag it across the screen to the Workspace and release to create a floating toolbar
- To close a floating toolbar, click on the X on the right of the toolbar title.

✓ Notes

The tool icons on the Drawing toolbar always indicate the last geometric shape drawn and may not be the same as the tool icons shown on the Drawing toolbar in this chapter. The last tool used remains on the Drawing toolbar making it easier to use the same tool again.

Text can be added to all of these geometric shapes. For more information, see Chapter 11, Advanced Draw Techniques.

Basic shapes

Clicking on the triangle ▼ to the right of **Basic Shapes** on the Drawing toolbar opens the Basic Shapes sub-toolbar (Figure 35). This sub-toolbar also includes rectangle and ellipse tools that are identical to the ones already displayed on the Drawing toolbar. Alternatively, select the required tool from the **Basic Shapes** panel in the Shapes deck on the Sidebar.

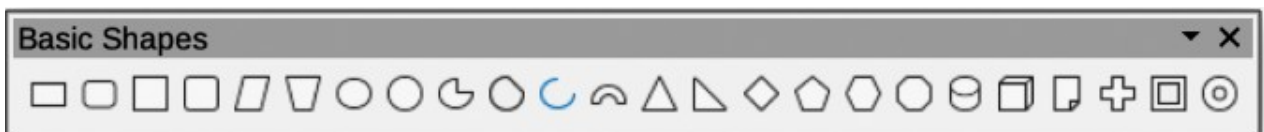

Figure 35: Basic Shapes sub-toolbar

Symbol shapes

Clicking on the triangle ▼ to the right of **Symbol Shapes** on the Drawing toolbar opens the Symbol Shapes sub-toolbar (Figure 36). Alternatively, select the required tool from the **Symbol Shapes** panel in the Shapes deck on the Sidebar.



Figure 36: Symbol Shapes sub-toolbar

Block arrows

Clicking on the triangle ▼ to the right of **Block Arrows** on the Drawing toolbar opens the Block Arrows sub-toolbar (Figure 37). Alternatively, select the required tool from the **Block Arrows** panel in the Shapes deck on the Sidebar.



Figure 37: Block Arrows sub-toolbar

Flowcharts

Clicking on the triangle ▼ to the right of **Flowchart** on the Drawing toolbar opens the Flowchart sub-toolbar (Figure 38) for symbols. Alternatively, select the required tool from the **Flowchart** panel in the Shapes deck on the Sidebar. The creation of flowcharts, organization charts, and similar planning tools are further described in Chapter 8 Connections, Flowcharts and Organization Charts.



Figure 38: Flowchart sub-toolbar

Callouts

Clicking on the triangle ▼ to the right of **Callout** on the Drawing toolbar opens the Callouts sub-toolbar (Figure 39). Alternatively, select the required tool from the **Callouts** panel in the Shapes deck on the Sidebar.



Figure 39: Callouts sub-toolbar

Stars and banners

Clicking on the triangle ▼ to the right of **Stars and Banners** on the Drawing toolbar opens the Stars and Banners sub-toolbar (Figure 40). Alternatively, select the required tool from the **Stars and Banners** panel in the Shapes deck on the Sidebar.

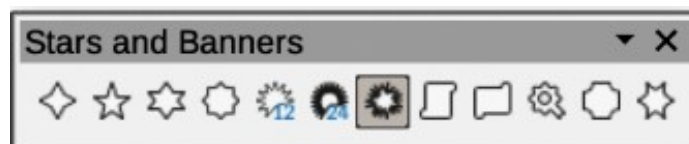

Figure 40: Stars and Banners sub-toolbar

3D Objects

Clicking on the triangle ▼ to the right of **3D Objects** on the Drawing toolbar opens the 3D-Objects sub-toolbar (Figure 41). Alternatively, select the required tool from the **3D-Objects** panel in the Shapes deck on the Sidebar.



Figure 41: 3D-Objects sub-toolbar

Adding, inserting and formatting text

In Draw text can be added, inserted, and formatted to in text boxes, objects, and shapes. For more information on how to add, insert, and format text in a drawing, see Chapter 9, Adding and Formatting Text.



LibreOffice
Community



Draw Guide 7.5

Chapter 3, Working with Objects

Introduction

This chapter explains the tools and functions for modifying existing drawings. Tools and functions only used and applied to a selected object or a group of selected objects. Selected objects are indicated by selection handles on a rectangular frame that is large enough to contain the object. Where several objects are selected, the frame around the objects corresponds to the smallest rectangle contains all objects. This frame is called the selection rectangle, or *marquee*.

✓ Note

The color and shape of selection handles changes depending on the tool and the function selected to change object properties. The color of selection handles also depends on the computer operating system and computer set up.

Selecting objects

Direct selection

Direct clicking on an object is the easiest way to select it. For objects that are not filled, click on the object border to select it. To select more than one object, hold the *Shift* key down while clicking on objects. To deselect an object, move the cursor into a blank space and click.

Selection by framing

Several objects are selected by clicking and dragging the cursor around the objects drawing a selection rectangle around the objects. Only objects that lie entirely within a selection rectangle are selected. Make sure **Select** on the Drawing toolbar is active when selecting multiple objects by framing, as shown in Figure 42.

Selecting hidden objects

Objects located behind other objects and not visible can still be selected. When a hidden object is selected, its selection handles appear through the objects covering the selected object.

- **Windows, Mac or Linux** — press the *Tab* key to select and cycle through objects in a drawing, stopping at the hidden object to select it. To cycle through objects in reverse order, press *Shift+Tab*.
- **Windows or Mac only** — select an object in front of a hidden object, then press the *Alt* key (macOS \backslash) and click to select the hidden object. If there are several hidden objects, keep holding down the *Alt* key (macOS \backslash) and click until the required object is reached. To cycle through the objects in reverse order, hold down the *Alt+Shift* keys (macOS \backslash +*Shift*) and click.

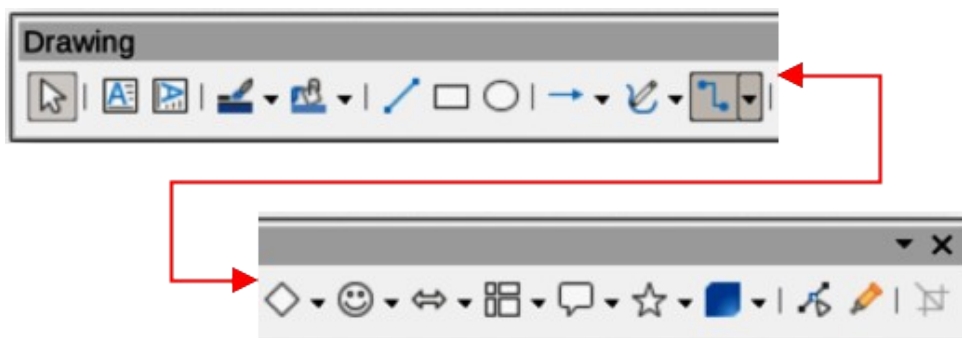

Figure 42: Drawing toolbar



Figure 43: Line and Filling toolbar

Arranging objects

In a complex drawing, several objects may be stacked on top of one another. Use one of the following methods to rearrange the stacking order by moving an object forward or backward:

- Select an object, go to **Shape > Arrange** on the Menu bar, or right-click on the object and select **Arrange** from the drop down menu, then use one of the following options:
 - **Bring to Front** (*Ctrl+Shift++*) (macOS $\text{⌘}+\text{Shift}++$)
 - **Bring Forward** (*Ctrl++*) (macOS $\text{⌘}++$)
 - **Send Backward** (*Ctrl+-*) (macOS $\text{⌘}+-$)
 - **Send to Back** (*Ctrl+Shift+-*) (macOS $\text{⌘}+\text{Shift}+-$)
 - **In Front of Object**
 - **Behind Object**
- Select an object, then select one of the **Arrange** tools at the left end of the Line and Filling toolbar (Figure 43). When the cursor hovers over a tool, its function is indicated.

Positioning and adjusting objects

Using zoom

For positioning and adjustment of objects, Draw has a zoom function that reduces or enlarges the screen display of the current drawing. For example, zoom in to position objects on a drawing with greater accuracy; zoom out to see the complete drawing. Zooming is controlled using the **Status Bar**, Zoom & View Layout dialog, or Zoom toolbar.

✓ Note

Zooming is handled differently in Linux operating systems. Drawings saved with 100% zoom factor in Windows or macOS are displayed at a larger zoom factor in Linux.

Status bar

The zoom controls are located on the right side of the **Status Bar** (Figure 44) giving easy access to zooming. Use one of the following methods to change the zoom factor:

- **Fit slide to current window** – fits the drawing to the open window.
- **Zoom Out** — minus sign (–) on the zoom slide control reduces the zoom factor.

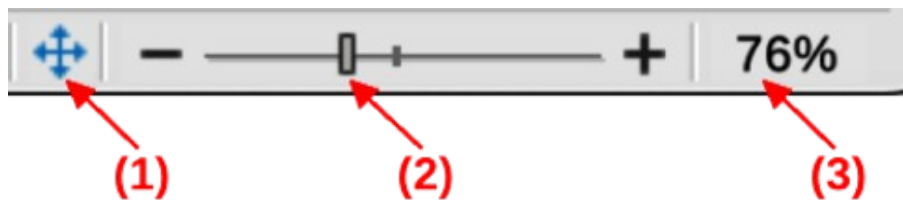

Figure 44: Status Bar zoom controls

- 1) Fit slide to current window
- 2) Zoom slide control
- 3) Zoom percentage

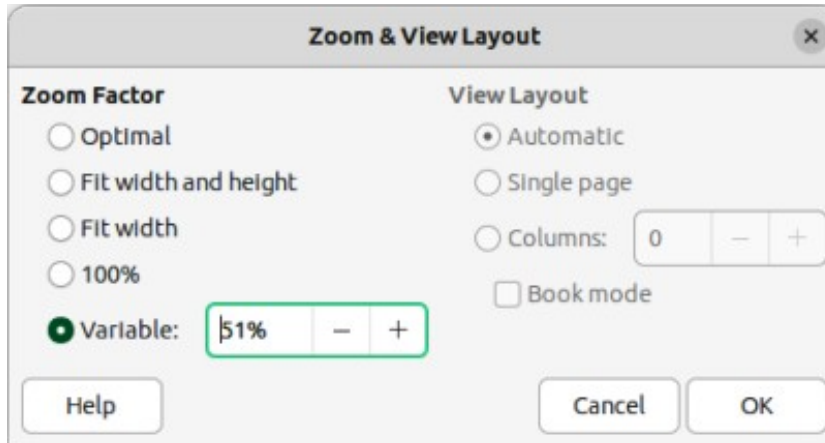

Figure 45: Zoom & View Layout dialog

- **Zoom In** — plus sign (+) on the zoom slide control increases the zoom factor.
- Click and drag the zoom slide control to increase or decrease the zoom factor.
- Right-click on the zoom percentage number and select a zoom option from the context menu that opens.

Zoom & View Layout dialog

Open the Zoom & View Layout dialog (Figure 45) using one of the following methods:

- Click on the zoom percentage number in the **Status Bar**.
- Go to **View > Zoom > Zoom** on the Menu bar.

The Zoom & View Layout dialog provides the following options for controlling how a drawing is viewed on a display.

Zoom Factor

Sets the zoom factor for displaying the current document and all documents of the same type that are subsequently opened.

Optimal

Resizes the display to fit the text width in the document.

Fit width and height

Displays the entire page on the screen.

Fit width

Displays the complete document page width. The top and bottom page edges may not be visible.

100%

Displays the document at its actual size.



Figure 46: Zoom toolbar

Variable

Enter a percentage in the box for the zoom factor to display the document.

View Layout

Used to set the view layout and is not available for drawings. View layout is normally used in text documents to see the effects of different layout settings.

Zoom toolbar

Go to **View > Toolbars > Zoom** on the Menu bar to open the Zoom toolbar (Figure 46). The tools available on this toolbar, from left to right, are as follows:

Zoom In

Displays the drawing at twice its current size each time the tool is selected.

Zoom Out

Displays the drawing at half its current size each time the tool is selected.

100%

Displays the drawing at its actual size.

Zoom Previous

Returns the drawing display to the previous zoom factor applied.

Zoom Next

Undo the action of the previous zoom command.

Entire Page

Displays the whole drawing in the **Workspace**.

Page Width

Displays the complete drawing width. The slide top and bottom edges may not be visible.

Optimal

Resizes the display to include all objects on the drawing.

Object Zoom

Resizes the display to fit the selected object(s).

Zoom & Pan

Zooms in for each click. *Ctrl+click* (macOS *⌘+click*) zooms out for each click. *Shift+click* allows panning of a drawing.

Shift

Moves the drawing within the **Workspace**. Place the cursor on the drawing and drag to move the drawing.

Moving and adjusting object size

When moving an object or changing its size, check the **Status Bar** left-hand area at the bottom of the **Workspace** (Figure 47). From left to right, this area shows a shape is selected, its position on the drawing in X/Y coordinates and object dimensions. The measurement units are selected in **Tools > Options > LibreOffice Draw > General** (macOS **Preferences > LibreOffice > LibreOffice Draw > General**).

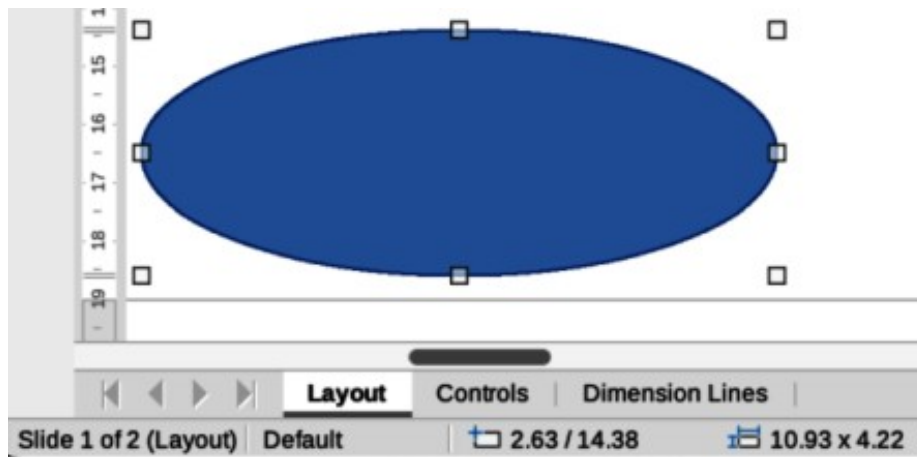

Figure 47: Left end of Status Bar with object selected

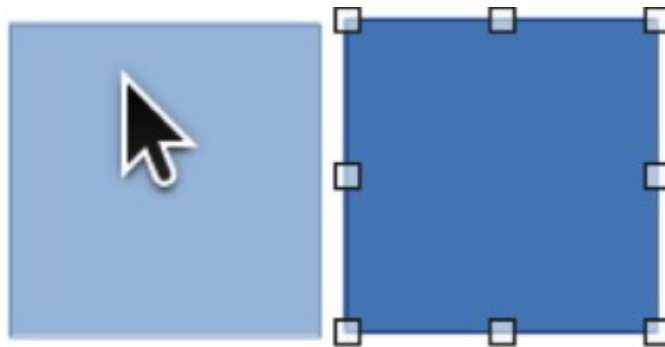

Figure 48: Example of moving objects

Moving objects

To move an object (or a group of objects), select it, then click and drag within the object borders. During movement, a ghost object image appears to help with repositioning, as shown in Figure 48. When the object reaches its new location, release the object.

Adjusting object size

To change the size of a selected object (or a group of selected objects), move the cursor to a selection handle. The cursor changes shape to indicate the direction of movement for that selection handle.

Click on a selection handle and drag it to change object size. The results depend on which selection handle is used.

- To resize an object in one axis, use a side, top, or bottom handle.
- To resize using both axes, use a corner handle.

As the object size changes, a ghosted object outline appears, as shown in Figure 49. When the required object size is reached, release the object.

✓ Note

Pressing and holding the *Shift* key while resizing an object. changes the size symmetrically keeping the aspect ratio of width to height the same. This *Shift* key behavior works on all selection handles.

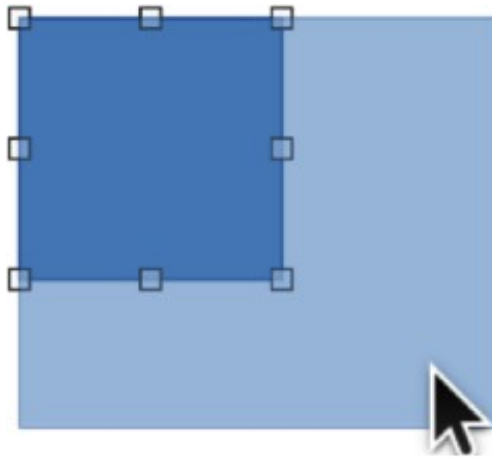

Figure 49: Example of adjusting objects



Figure 50: Example of modifying arcs

Modifying arcs

The size of an arc is changed by adjusting the positions of the start and end points of an arc. The selection handle at the start point of an arc is larger than the end point of an arc.

- 1) Select an arc, then right click on the arc and select **Points** from the drop down menu, or press the *F8* key. Two handles appear at the start and end of the arc, as shown in Figure 50
- 2) Click and drag on the start or end handle to change the arc shape.
- 3) Release the selected handle when the required arc shape is achieved.

Rotating and slanting objects

Rotating objects

To rotate an object (or a group of objects), select the object and change to rotation mode using one of the following methods.

- 1) Select an object so that the selection handles are displayed.
- 2) Use one of the following methods to switch to rotation mode. The selection handles change shape and color and a center of rotation indicator appears in the object center, as shown in Figure 51.
 - Click again on a selected object.

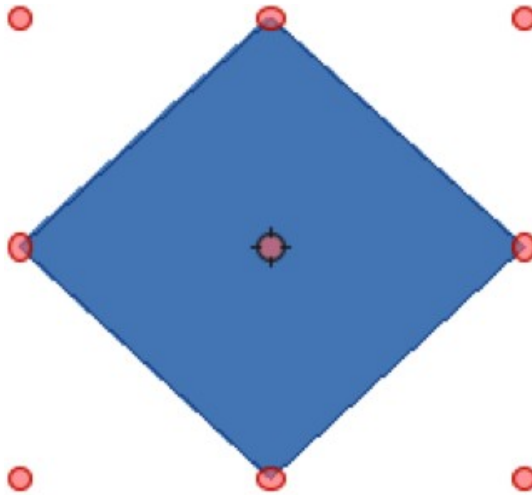

Figure 51: Example of rotation mode

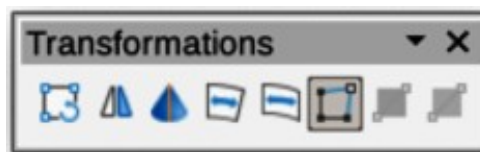

Figure 52: Transformations toolbar

- Click on the triangle ▼ on the right of **Transformations** on the Line and Filling toolbar and select **Rotate** from the pop up menu.
 - Go to **View > Toolbars > Transformations** on the Menu bar to open the Transformations toolbar (Figure 52) and select **Rotate**.
- 3) Move the cursor over a corner selection handle and the cursor changes shape to indicate rotation mode.
 - 4) Click on the corner selection handle and drag it to rotate the object. Release the selection handle when the required object rotation is reached.

✓ Notes

The rotation center is normally located at the center of an object. To change the rotation center position, click on the rotation center and drag it until it is at the desired position. This rotation center can even be outside of the object.

Rotation works in a slightly different way for 3D objects because it occurs in a three dimensional space and not in a single plane. See Chapter 7, Working with 3D Objects for more information.

Slanting objects

The axis used for slanting an object is the object edge directly opposite the midpoint handle being used to slant the object. This axis is fixed in location while the other sides of the object move in relation to it as the selection handle is dragged. In Figure 53 the selection handle at the object bottom has been used to slant the object.

- 1) Select an object and use one of the following methods to switch to rotation mode. The selection handles change shape and color and a center of rotation indicator appears in the object center.
 - Click again on a selected object.

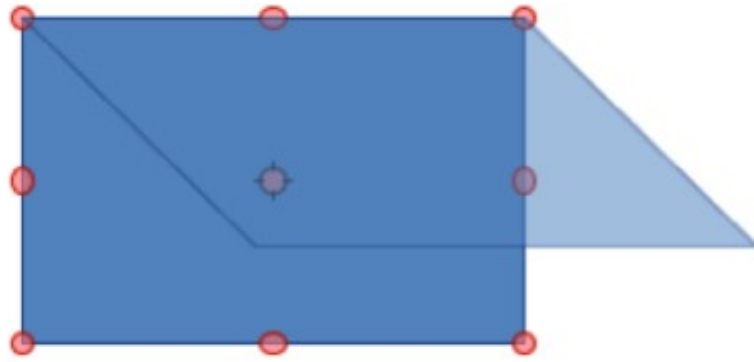

Figure 53: Example of slanting objects

- Click on the triangle ▼ on the right of **Transformations** on the Line and Filling toolbar and select **Rotate** from the pop up menu.
 - Go to **View > Toolbars > Transformations** on the Menu bar to open the Transformations toolbar and select **Rotate**.
- 2) Move the cursor over a selection handle at the midpoint of the object top, bottom, left or right sides and the cursor changes shape to indicate slanting direction.
 - 3) Click and drag the selection handle to slant the object. Release the cursor when the desired object slant is reached. A ghosted object outline being slanted appears and the current angle of slanting is shown in the **Status Bar**.

✓ Note

Press and hold the *Shift* key while rotating or slanting an object restricts movement to 15° steps. This is the default behavior of the *Shift* key. However, if **When creating or moving objects** has been selected in **Tools > Options > LibreOffice Draw > Grid** (macOS **LibreOffice > Preferences > LibreOffice Draw > Grid**), the *Shift* key action is reversed and rotation or slanting is restricted to 15° of movement unless the *Shift* key is pressed.

Setting exact position, size, rotation and slant

Using the cursor to position and resize objects is not exact. If greater accuracy is required to position and size an object, it is recommended to use the Position and Size dialog (Figure 54), or the **Position and Size** panel (Figure 55) in the Properties deck on the Sidebar.

- To open the Position and Size dialog, select an object and use one of the following methods:
 - Go to **Format > Position and Size** on the Menu bar.
 - Right-click on the object and select **Position and Size** from the context menu.
 - Use the keyboard shortcut *F4*.
- To open the **Position and Size** panel in the Properties deck on the Sidebar, select an object, then click on **Properties** on the Sidebar and click on the chevron > on the **Position and Size** title bar to open the panel.

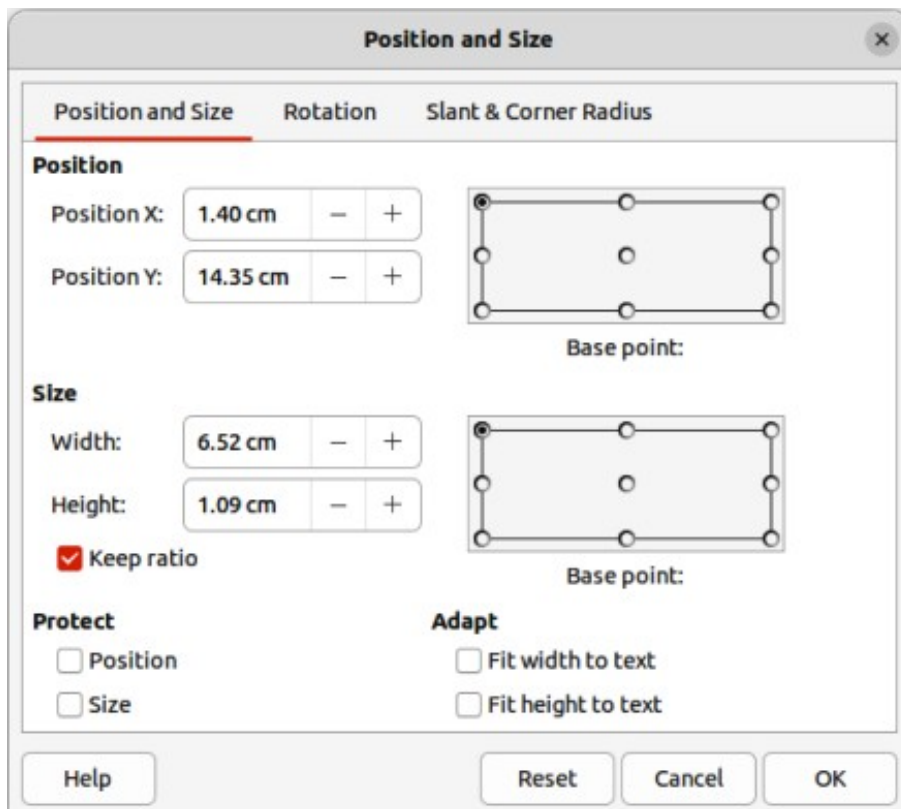

Figure 54: Position and Size dialog

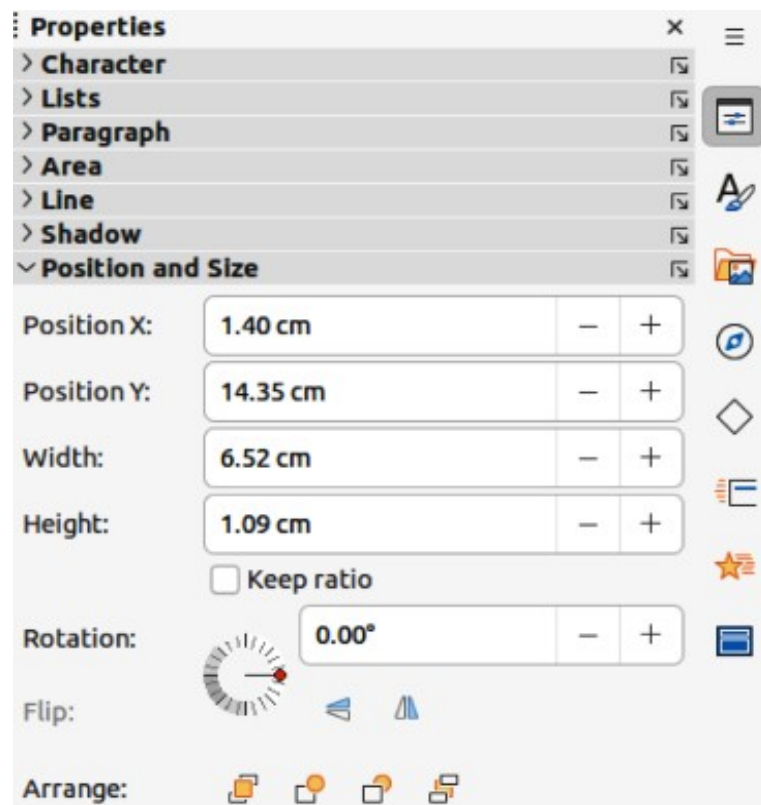

Figure 55: Position and Size panel in Properties deck on Sidebar

Position and Size

Position

Specify the selected object location on the page. The units of measurement used for X/Y coordinates, and the object width and height are set by going to **Tools > Options > LibreOffice Draw > General** (macOS **LibreOffice > Preferences > LibreOffice Draw > General**).

Position X

Enter the horizontal distance required to move the object relative to the base point selected in the grid.

Position Y

Enter the vertical distance required to move the object relative to the base point selected in the grid.

Base point

Select a base point in the grid and then enter the amount required to shift the object relative to the base point that is selected in the *Position Y* and *Position X* boxes. The base points correspond to the selection handles on an object. This option is only available in the Position and Size dialog.

Size

Specify the amount required to resize the selected object with respect to the selected base point.

Width

Enter a width for the selected object.

Height

Enter a height for the selected object.

Keep ratio

Maintains proportions when resizing the selected object.

Base point

Select a base point in the grid, and then enter the new size dimensions for the selected object in the *Width* and *Height* boxes. This option is only available in the Position and Size dialog.

Protect

This option is only available in the Position and Size dialog.

Position

Prevents changes to the position or the selected object size .

Size

Prevents object resizing.

Adapt

Specifies, if the size of a text box should be adjusted to fit the size of entered text. This option is only available in the Position and Size dialog for text boxes.

Fit width to text

Expands the object width to the text width, if the object is smaller than the text.

Fit height to text

Expands the object height to the text height, if the object is smaller than the text.

✓ Note

The base points default location for position and size is the upper left corner of the drawing area. This base point can be temporarily changed to make positioning or dimensioning simpler by clicking on a position corresponding to the base point location. This change in base point is only valid for single use and the base point is reset to the standard position of top left corner when the Position and Size dialog is closed.

Rotating objects

To accurately rotate an object, click on the **Rotation** tab of the Position and Size dialog to open the **Rotation** page (Figure 56). The options available allow the rotation angle and the pivot point location to be defined. Alternatively, use the available options for rotation in the **Position and Size** panel in the Properties deck on the Sidebar.

Pivot Point

The selected object is rotated around a specified pivot point and is only available in the Position and Size dialog. The default position for the pivot point is at the object center. The pivot point can be moved from its default central position by changing the setting for *Position X* and/or *Position Y*, or selecting a position in *Default settings*.

Position X

Enter horizontal distance from the page left edge to change the pivot point position.

Position Y

Enter vertical distance from the page top edge to change the pivot point position.

Default settings

Select the pivot point position. Default position is the object center. Changing the pivot point is valid for single use only and is reset to the default central position when the Position and Size dialog is closed.

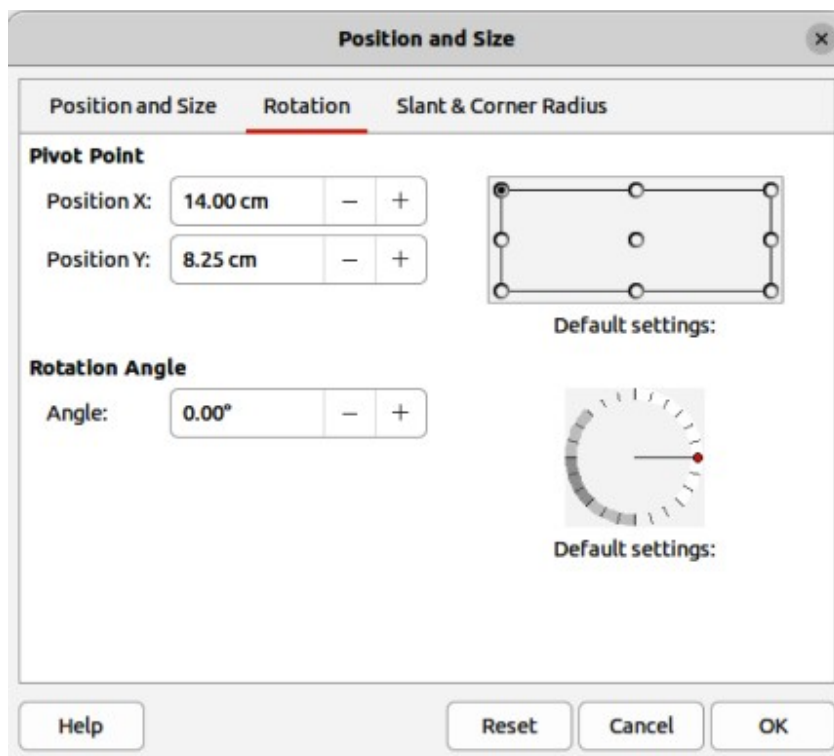

Figure 56: Position and Size dialog — Rotation page

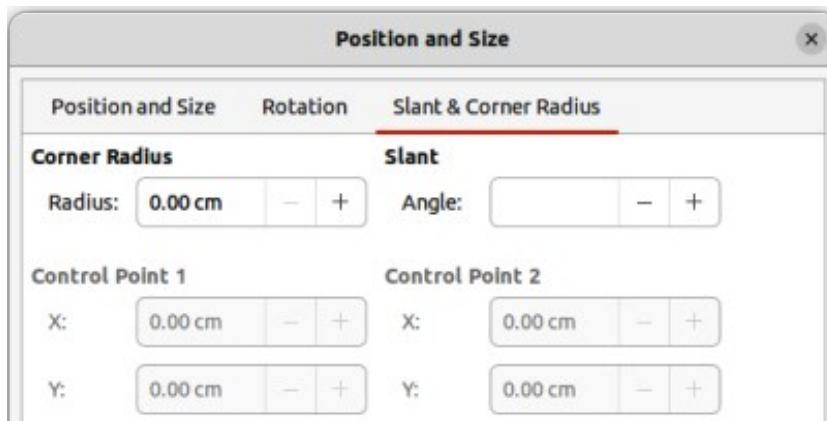

Figure 57: Position and Size dialog — Slant & Corner Radius page

Rotation Angle

Specify the number of degrees required to rotate the selected object. This option is only available in the Position and Size dialog.

Angle

Enter the number of degrees that required to rotate the selected object.

Default settings

Click on the indicator to rotate the object. The number of degrees rotated is shown in the *Angle* box.

Slant and corner radius

To accurately set the corner radius or slant angle of an object, click on the **Slant & Corner Radius** tab of the Position and Size dialog (Figure 57). Options for slant and corner radius are only available in the Position and Size dialog.

Corner Radius

This option is only available for the corners of a rectangular or square object that has been created using the Legacy Rectangles toolbar. This toolbar is optional and is opened by going to **View > Toolbars > Legacy Rectangles** on the Menu bar. If this option is grayed out, the corner radius cannot be set.

Radius

Enter the circle radius that is to be used to round corners. The larger the value for corner radius set, the rounder corners of a rectangle or square become.

Slant

Slants the selected object along the object bottom edge.

Angle

Enter the slant axis angle. The slant angle relates to how much an object inclines or slants from its normal vertical position on a drawing.

Control Point 1/Control Point 2

These control points are special handles or dots that are available on some shapes and are used to change the properties of a shape. If these options are grayed out, then the shape does not have a special handle and coordinates cannot be set.

Enter a value to set the special handle X and Y coordinates in relation to the shape top left corner. The example shown in Figure 58 shows the shape change after adjusting the X coordinate of Control Point 1 of the special handle.

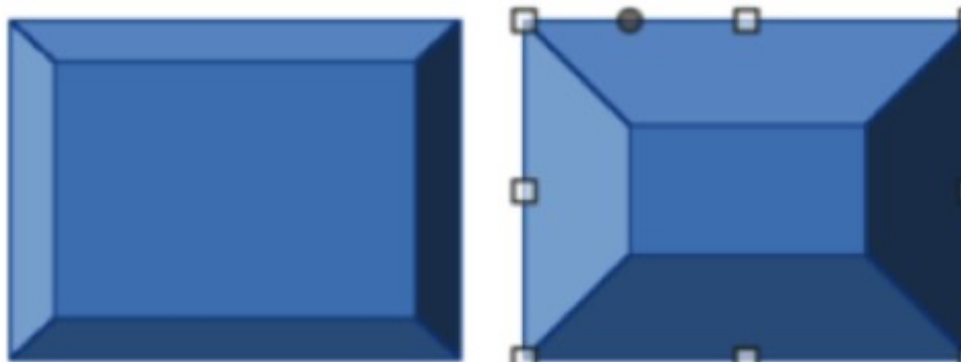

Figure 58: Example of corner point adjustment

✓ Note

For more information on this special handle used for control points, see “Changing object shape” on page 66.

Using grid and snap functions

Position objects accurately using the grid and snap functions available in Draw. It is recommended to use the highest practical zoom value for a drawing when using the grid and snap functions. Two different functions can be used at the same time, for example, snapping to a guide line and the page edge. It is also recommended to activate only snap functions that are necessary.

Configuring grid and snap

To configure the grid and snap functions in a drawing, go to **Tools > Options > LibreOffice Draw > Grid** (macOS **LibreOffice > Preferences > LibreOffice Draw > Grid**) on the Menu bar to open the Grid dialog (Figure 59). Grid and snap functions are displayed and switched on or off using one of the following methods:

- Using Options LibreOffice Grid dialog (Figure 59).
- Right clicking on a drawing and selecting options from the context menu.
- Using the tools on the Options toolbar (Figure 60). If the Options toolbar is not open, go to **View > Toolbars > Options** on the Menu bar.

Grid and snap functions

Grid

Specifies the settings for the configurable grid in a drawing and helps to determine the exact position of objects. Also, this grid can be set in line with the magnetic snap grid. If the snap grid is activated, but want to move or create individual objects without snap positions, keep the *Shift* key pressed to deactivate this function.

Snap to grid

Specifies whether to move frames, drawing elements, and controls only between grid points. To change the snap grip status only for the current action, drag an object while holding down the *Ctrl* key (macOS ⌘).

Visible grid

Specifies whether to display the grid.

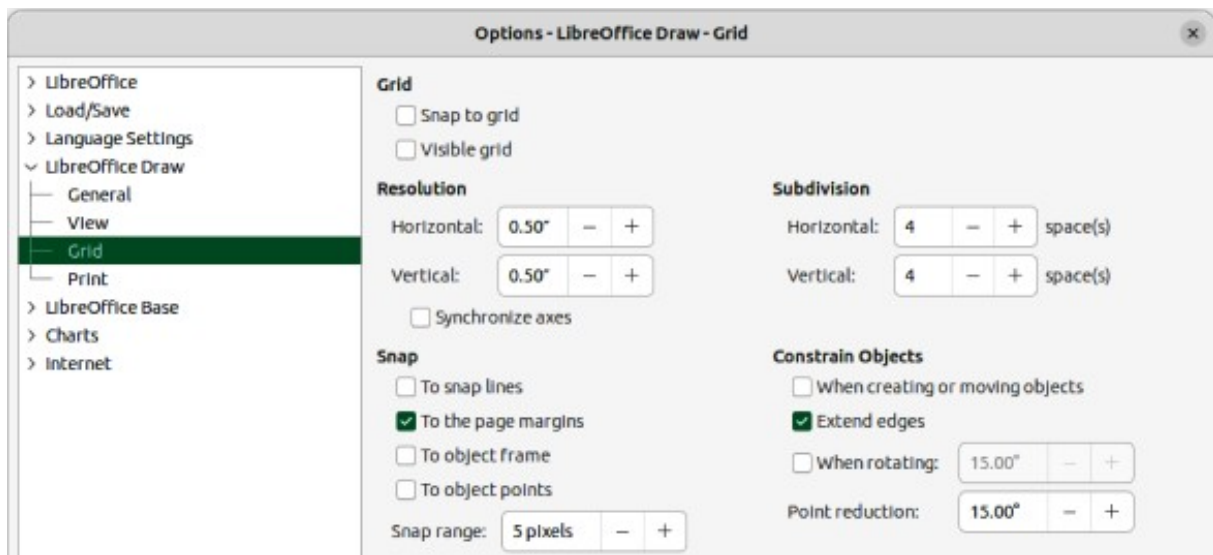

Figure 59: Options LibreOffice Draw dialog — Grid page

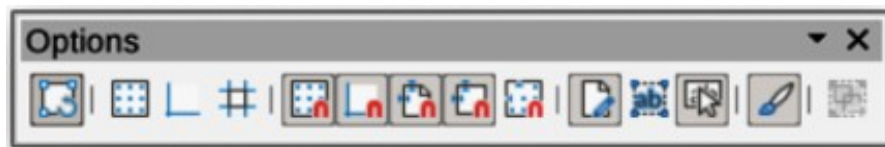

Figure 60: Options toolbar

Resolution

Horizontal

Defines the unit of measure for the spacing between grid points on the X-axis.

Vertical

Defines the grid points spacing in the desired unit of measurement on the Y-axis.

Synchronize axes

Specifies whether to change the current grid settings symmetrically. The resolution and subdivision for the X and Y axes remain the same.

Subdivision

Horizontal

Specify the number of intermediate spaces between grid points on the X-axis.

Vertical

Specify the number of intermediate spaces between grid points on the Y-axis.

Snap

To snap lines

Snaps the edge of a dragged object to the nearest snap line when the click is released. This setting can also be defined using **Snap to Snap Guides** on the Options toolbar.

To the page margins

Specifies whether to align the graphic object contour to the nearest page margin. The cursor or a contour line of the graphics object must be in the snap range. This function can also be accessed using **Snap to Page Margins** in the Options toolbar.

To object frame

Specifies whether to align the graphic object contour to the border of the nearest graphic object. The cursor or a contour line of the graphics object must be in the snap range. This function can also be accessed with **Snap to Object Border** in the Options toolbar.

To object points

Specifies whether to align the graphic object contour to the points of the nearest graphic object. This only applies if the cursor or a contour line of the graphics object is in the snap range. This function can also be accessed with **Snap to Object Points** in the Options toolbar.

Snap range

Defines the snap distance between the cursor and the object contour. Snaps to a snap point if the cursor is closer than the distance selected.

Constrain Objects

When creating or moving objects

Specifies that graphic objects are restricted vertically, horizontally or diagonally (45°) when creating or moving them. This setting can be temporarily deactivated by pressing the *Shift* key.

Extend edges

Specifies that a square is created based on the longer side of a rectangle when the *Shift* key is pressed before releasing the click. This also applies to an ellipse (a circle is created based on the ellipse longest diameter). When *Extend edges* is not selected, a square or a circle is created based on the shorter side or diameter.

When rotating

Specifies that graphic objects can only be rotated within the rotation angle that is selected. To rotate an object outside the defined angle, press the *Shift* key when rotating. Release the key when the desired rotation angle is reached.

Point reduction

Defines the angle for point reduction. When working with polygons, this may be useful in reducing the editing points.

Snap to grid

Using Snap to Grid

Using **Snap to Grid** helps in moving an object onto a grid point in a drawing. This function is selected using one of the following methods:

- Go to **View > Snap Guides > Snap to Grid** on the Menu bar.
- Right-click on a drawing and select **Snap Guides > Snap to Grid** from the context menu.
- Click on **Snap to Grid** on the Options toolbar.

Displaying grid

Use one of the following methods to display or turn off the grid in a drawing:

- Go to **View > Grid and Helplines > Display Grid** on the Menu bar.
- Click on **Display Grid** on the Options toolbar.
- Right-click on a drawing and select **Grid and Helplines > Display Grid** from the context menu.
- Select **Visible grid** in the Options LibreOffice Draw Grid dialog.

Changing color of grid points

By default and depending on the computer setup, grid points are gray and not always easy to see. Change the grid point color as follows:

- 1) Go to **Tools > Options > LibreOffice > Application Colors** (macOS **LibreOffice > Preferences > LibreOffice > Application Colors**) to open the Application Colors dialog (Figure 61).
- 2) Go to **Drawing/Presentation** and select a more suitable color for the grid from the drop-down list.
- 3) Click on **OK** to save the changes and close the dialog.

Snap points and lines

Snap lines and snap points are not part of the grid, but are inserted to position an object at a specific position in a drawing. Snap lines can either be horizontally or vertically and appear as dashed lines. Snap points appear as small crosses with dashed lines. Snap points and snap lines do not appear in printed output.

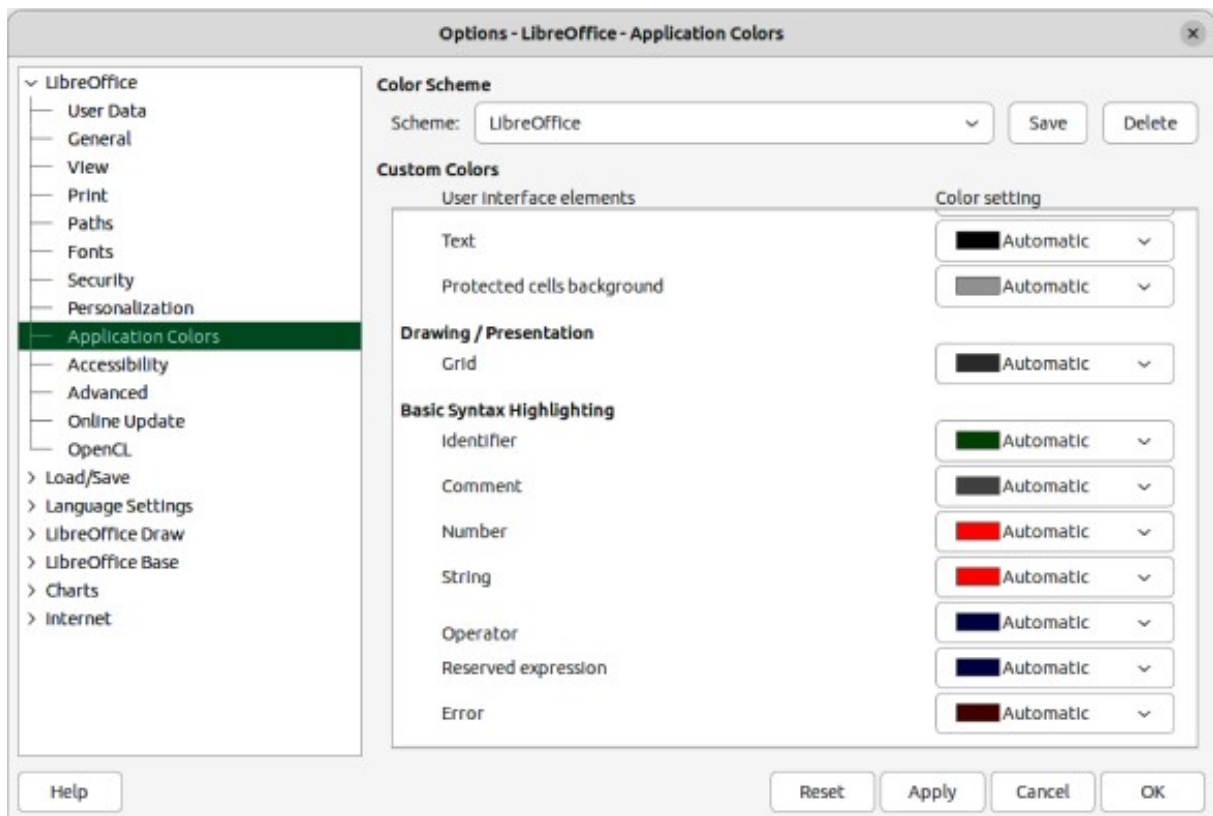

Figure 61: Options LibreOffice dialog — Application Colors page

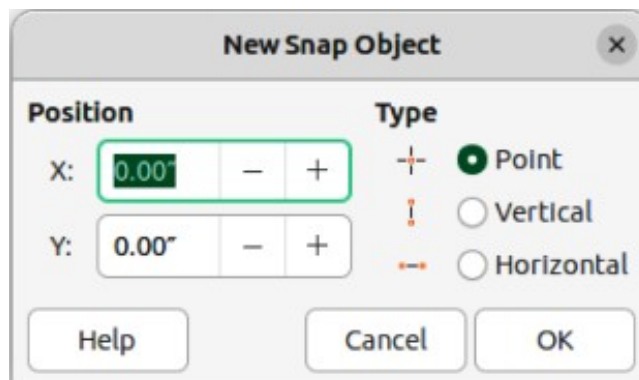

Figure 62: New Snap Object dialog

Inserting snap points and snap lines

To insert a snap point or snap line, go to **Insert > Snap Guide** on the Menu bar to open the New Snap Object dialog (Figure 62).

Position

Sets the position of a selected snap point or line relative to the top left page corner.

X:

Enter the amount of space required between the snap point or line and the page left edge.

Y:

Enter the amount of space required between the snap point or line and the page top edge.

Type

Specifies the type of snap object being inserted.

Point

Inserts a snap point.

Vertical

Inserts a vertical snap line.

Horizontal

Inserts a horizontal snap line.

Displaying snap points and lines

Use one of the following methods to display snap points and lines in a drawing:

- Go to **View > Snap Guides > Display Snap Guides** on the Menu bar.
- Click on **Display Snap Guides** in the Options toolbar.
- Right-click on a drawing and select **Snap Guides > Display Snap Guides** from the context menu.

Editing snap points

- 1) Right-click on the snap point and select **Edit Snap Point** from the context menu to open the Edit Snap Point dialog (Figure 63).
- 2) Enter new X and Y coordinate settings for the snap point and click **OK**.
- 3) Alternatively, click and drag a snap point to a new position on a drawing.

Editing snap lines

- 1) Right-click on the snap line and select **Edit Snap Line** from the context menu to open the Edit Snap Line dialog (Figure 64).

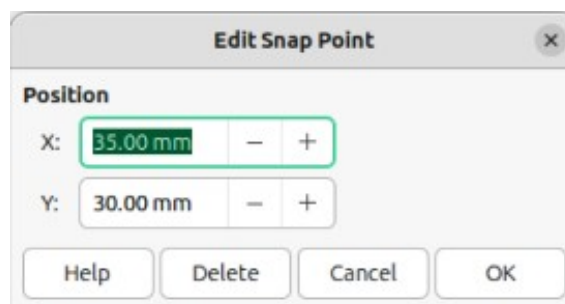

Figure 63: Edit Snap Point dialog

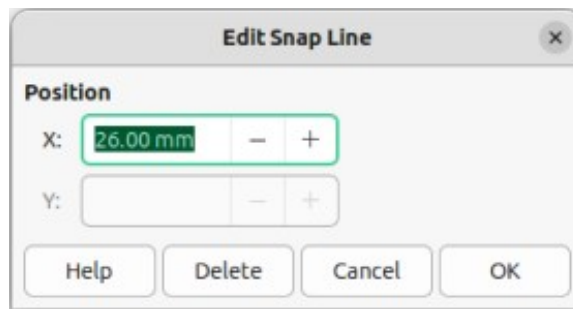

Figure 64: Edit Snap Line dialog

- 2) Enter a new X coordinate setting for vertical snap lines or a new Y coordinate setting for horizontal snap lines and click **OK**.
- 3) Alternatively, click and drag a snap line to a new position on a drawing.

Deleting snap points and lines

To delete a snap point, drag it back to a ruler or right-click on the snap point and select **Delete Snap Point** from the context menu.

To delete a snap line, drag it back to the ruler or right-click on the snap line and select **Delete Snap Line** from the context menu.

Configuring snap range

To configure the snap range of when an object snaps to a position in the drawing:

- 1) Go to **Tools > Options > LibreOffice Draw > Grid** (macOS **LibreOffice > Preferences > LibreOffice Draw > Grid**) on the Menu bar to open the Options LibreOffice Grid dialog.
- 2) Enter the number of pixels to set the proximity of when the object snaps into position in the *Snap range* box. The default setting is 5 pixels.
- 3) Click **OK** to set the new snap range and close the dialog.

Using Helplines

Helplines are a Draw function for positioning of objects. Helplines are displayed while the object is being moved. Helplines extend from the object edges to the rulers at the top and left side of a drawing and do not have a snap function (Figure 65).

- 1) Go to **Tools > Options > LibreOffice Draw > View** (macOS **LibreOffice > Preferences > LibreOffice Draw > View**) on the Menu bar to open the Options LibreOffice Draw View dialog (Figure 66).

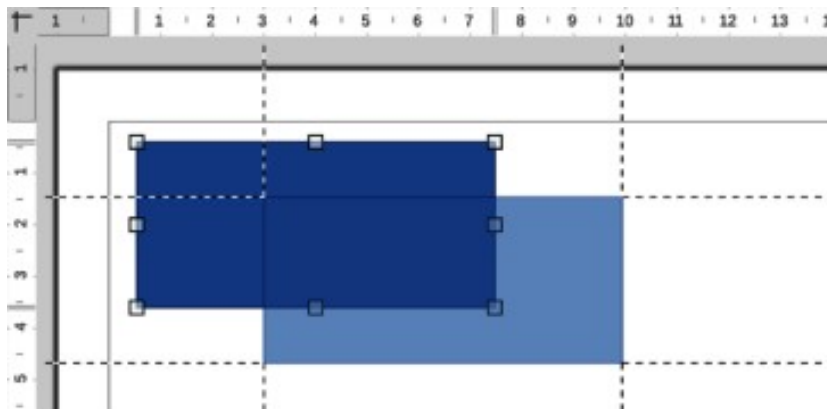

Figure 65: Example of using helplines while moving objects

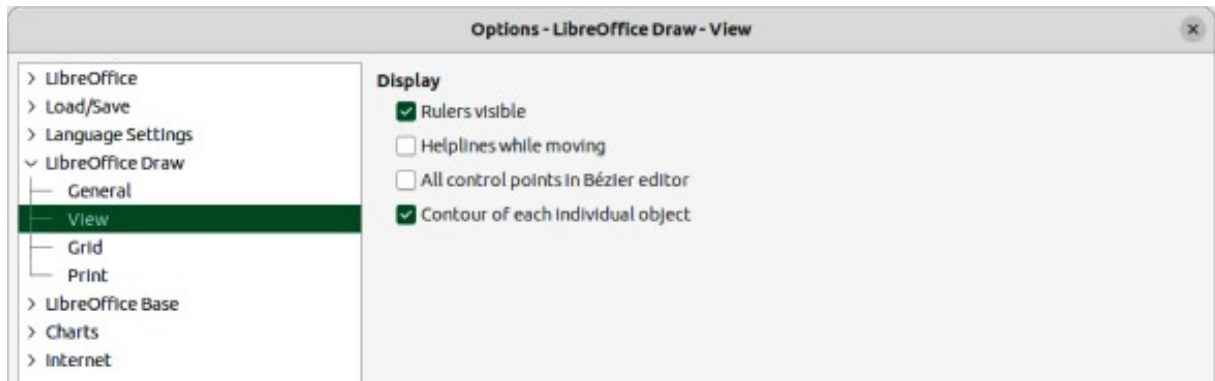

Figure 66: Options LibreOffice Draw dialog — View page

- 2) Select *Helplines when moving* option or click *Helplines While Moving* in the Options toolbar.
- 3) Click **OK** to save the selection and close the dialog.

Changing object shape

Regular shapes

When creating regular shapes in a drawing, some shapes have one or more control dots displayed in a different color to the selection handles when an object is selected. When the cursor hovers over one of these dots, it changes shape. Clicking and dragging on these dots modifies the object shape. For example, increasing corner radius of a rounded rectangle or square, changes the angles of an arc, and so on. These dots perform different functions according to the shape selected.

Note

After converting a regular shape to a curve or polygon, the shape of a regular shape can be changed and points can be edited. See “Curves and polygons” on page 69 and “Editing points” on page 70 for more information.

Basic shapes

The following basic shapes (Figure 67), from left to right, have adjustment dots.

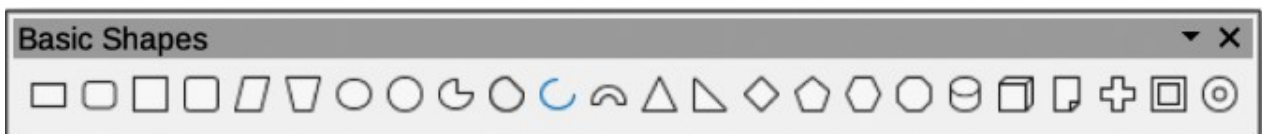

Figure 67: Basic Shapes sub-toolbar

Basic Shapes	Adjustment dot description
Rectangle, Rounded	Changes the curve radius that replaces the angled corners of a rectangle or square.
Square, Rounded	Changes the curve radius that replaces the angled corners of a rectangle or square.
Parallelogram	Changes the internal angles between the sides.
Trapezoid	Changes the internal angles between the sides.
Circle Pie	Changes the size of the filled sector.

Block Arc	Changes both internal diameter and size of the filled area.
Isosceles Triangle	Changes the shape and type of the triangle.
Hexagon	Changes the internal angles between the sides.
Octagon	Changes the internal angles between the sides.
Cylinder	Changes the perspective.
Cube	Changes the perspective.
Folded Corner	Changes the folded corner size.
Cross	Changes the thickness of the cross four arms.
Frame	Changes the frame thickness.
Ring	Changes the ring internal diameter.

Symbol Shapes

The following symbol shapes (Figure 68), from left to right, have adjustment dots.



Figure 68: Symbol Shapes sub-toolbar

Symbol Shapes	Adjustment dot description
Smiley Face	Changes the smile on the face.
Heart	Changes the symbol shape.
Sun	Changes the symbol shape.
Moon	Changes the symbol shape.
Prohibited	Changes the ring thickness and the diagonal bar.
Square Bevel	Changes the bevel thickness.
Octagon Bevel	Changes the bevel thickness.
Diamond Bevel	Changes the bevel thickness.
Double Bracket	Changes the bracket curvature.
Left Bracket	Changes the bracket curvature.
Right Bracket	Changes the bracket curvature.
Double Brace	Changes the bracket curvature.
Left Brace	Changes the brace curvature and the position of the point.
Right Brace	Changes the brace curvature and the position of the point.

Block Arrows

The following block arrows (Figure 69), from left to right, have adjustment dots.



Figure 69: Block Arrows sub-toolbar

Block Arrows	Adjustment dot description
Right Arrow	Changes the arrow shape and thickness.
Left Arrow	Changes the arrow shape and thickness.
Down Arrow	Changes the arrow shape and thickness.
Up Arrow	Changes the arrow shape and thickness.
Left and Right Arrow	Changes the arrow shape and thickness.
Up and Down Arrow	Changes the arrow shape and thickness.
Circular Arrow	Changes the arrow shape and thickness.
4-way Arrow	Changes the arrow shape and thickness.
Chevron	Changes the angle between the sides and the shape.
Pentagon	Changes the angle between the sides and the shape.
Striped Right Arrow	Changes the arrow shape and thickness.
Up, Right and Down Arrow	Changes the arrow shape and thickness.
Notched Right Arrow	Changes the arrow shape and thickness.
Up and Right Arrow	Changes the arrow shape and thickness.
Right Arrow Callout	Changes the callout shape and thickness.
Left Arrow Callout	Changes the callout shape and thickness.
Down Arrow Callout	Changes the callout shape and thickness.
Up Arrow Callout	Changes the callout shape and thickness.
Left and Right Arrow Callout	Changes the callout shape and thickness.
Up and Down Arrow Callout	Changes the callout shape and thickness.
4-way Arrow Callout	Changes the callout shape and thickness.
Up and Right Arrow Callout	Changes the callout shape and thickness.

Callouts

For all callouts (Figure 70) use the adjustment dots to change the length, position and angle of the pointer.

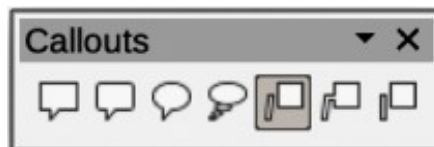

Figure 70: Callouts sub-toolbar

Stars and Banners

The following stars and banners (Figure 71), from left to right, have adjustment dots.



Figure 71: Stars and Banners sub-toolbar

Stars and Banners	Adjustment dot description
4-Point Star	Changes the star points thickness and shape.
8-Point Star	Changes the star points thickness and shape.
24-Point Star	Changes the star points thickness and shape.
Vertical Scroll	Changes the scroll width and shape.
Horizontal Scroll	Changes the scroll width and shape.
Doorplate	Changes the inward curvature of the corners.

Curves and polygons

Bézier curves

The editing of curves and polygons depends on the mathematics of Bézier curves¹. Fully explaining Bézier curves goes beyond the scope of this Draw Guide. For more information on drawing and manipulating Bézier curves, see Chapter 11, Advanced Draw Techniques.

Editing a Bézier curve is the movement of points or tangents passing through a point. Each tangent has a control point at each end and a junction point where it meets a curve. The relative angle and distance between control points determines the curve shape. Figure 72 shows what happens to a square and changing only one point on the square.

Converting objects to curve or polygon

When changing the shape of an object and before modifying the points on an object, it must be converted to a curve or a polygon. Depending on what kind of shape and effect required to produce using one of the following methods to create a curve or a polygon:

- After selecting an object, go to **Shape > Convert** on the Menu bar and select either **To Curve** or **To Polygon**.
- Right click on an object and select **Convert > To Curve** or **To Polygon** from the context menu.

1 Bézier curves were invented by Pierre Bézier, who developed the technique in the 1960s and while as an engineer with the Renault car manufacturer. The technology was intended to make modeling the surface of vehicles easier.

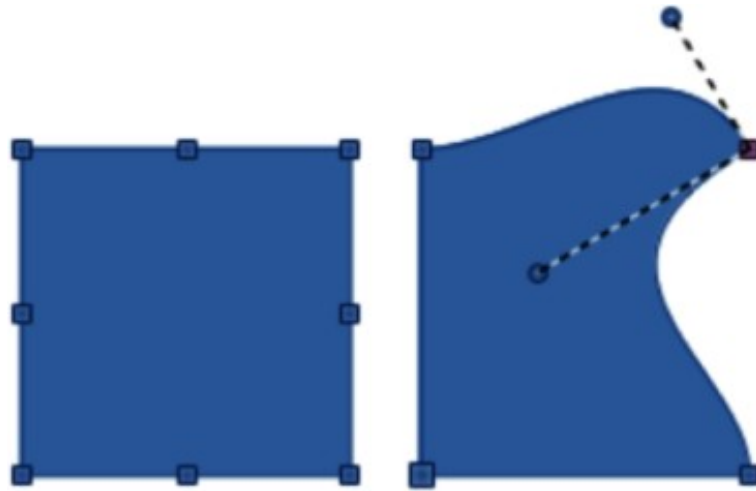

Figure 72: Example of creating different shapes by changing tangent points



Figure 73: Edit Points toolbar

✓ Note

After switching to points editing mode, the selection handles become points. The number of points may increase or reduce in number. This change in number depends on the object shape and is normal behavior.

Editing points

Many different shapes can be created by moving either the point, or one or both of the round handle points at either end of the tangent, as shown in Figure 72. Points can be added, deleted, or points type changed using tools available on the Edit Points toolbar (Figure 73).

After converting a shape to a curve or polygon, object points are edited as follows:

- 1) Select the object and select points editing mode using one of the following methods.
 - Go to **Edit > Points** on the Menu bar.
 - Click on the **Points** tool on the Standard toolbar.
 - Right click on the converted object and select **Points** from the context menu.
 - Use the keyboard shortcut **F8**.
- 2) Click on an object point to change the object shape. The Edits Points toolbar opens and the tools become active when a point is selected. Tangents also appear attached to the selected point.
- 3) Use the various tools on the Edit Points toolbar to add, delete, or change the point type.
- 4) Click and drag a point to move the point and change object shape.
- 5) If the selected object is a curve, click on and drag the round points at the end of a tangent to change the object shape.

- 6) When satisfied with the shape, click outside of the object to cancel points editing mode and close the Edit Points toolbar.

Point types

The available tools on the Edit Points toolbar depend on the object and type of object point that has been selected.

Move Points

Activates a mode allowing movement of points. Click, hold and drag the selected point to another location.

Insert Points

Activates the insert mode allowing points to be inserted. A point is inserted onto a selected object each time a click is made. The object also changes shape to include a new point into the object border. Inserted points are a smooth point.

Delete Points

Deletes points from the selected object. Select **Delete Points** and then click on a point to delete. To delete several points, hold down the *Shift* key as each point is selected for deletion, then click on **Delete Points**.

Convert To Curve

Converts a curve into a straight line, or a straight line into a curve. If a single point is selected, the curve before the point is converted. If two points are selected, the curve between both points is converted. If more than two points are selected and each time **Convert to Curve** is clicked, a different portion of the curve is converted. If necessary, round points are converted into corner points and corner points are converted into round points.

If a curve section is a straight line, the line end points have a maximum of one control point each. They cannot be modified to round points unless the straight line is converted back to a curve.

Close Bézier

Closes a curve. A curve is closed by connecting the last point with the first point, indicated by an enlarged square.

Split Curve

Select the point or points, then click on **Split Curve**.

Corner Point

Converts a selected point or points into corner points. Corner points have two movable control points, which are independent from each other. A curved line does not go straight through a corner point, but forms a corner.

To create a corner point, a smooth or a symmetrical point must be inserted first and then converted to a corner point by clicking on **Corner Point**.

Smooth Transition

Converts a corner point, or symmetrical point into a smooth point. Both control points of a corner point are aligned in parallel and are only moved simultaneously. Control points may have different lengths, allowing variation in the degree of curvature.

Symmetric Transition

Converts a corner point or a smooth point into a symmetrical point. Both control points of a corner point are aligned in parallel and have the same length. They can only be moved simultaneously and the degree of curvature is the same in both directions.

Eliminate Points

Marks selected points for deletion when a point is located on a straight line. When using **Convert to Curve** to convert a curve or a polygon into a straight line, or alter a curve using the cursor so that a point lies on the straight line, the selected point is deleted. The angle from when a point is deleted is 15° by default.

Tangents

Before using tangents on an object, it must be converted to a curve. Tangents are only used on curves. If an object has been converted to a polygon and a tangent is added, the object is automatically converted to a curve.

✓ Note

The tangent angle relates to an object shape that is changed by selecting a tangent control point at the end of a tangent and moving it. As the tangent angle is changed, the object shape changes in response.

Symmetric transition

Symmetric transition converts a corner or smooth point into a symmetrical point. Tangents have the same length and are aligned in a straight line, as shown in Figure 74. Tangents can only be moved simultaneously and the degree of curvature is the same in both directions.

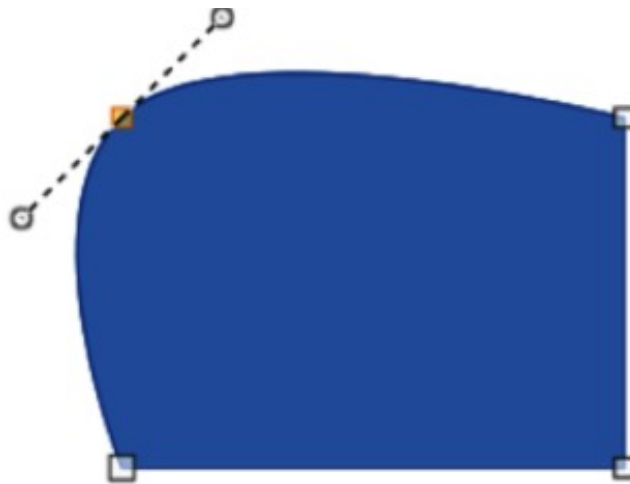

Figure 74: Example of symmetric transition

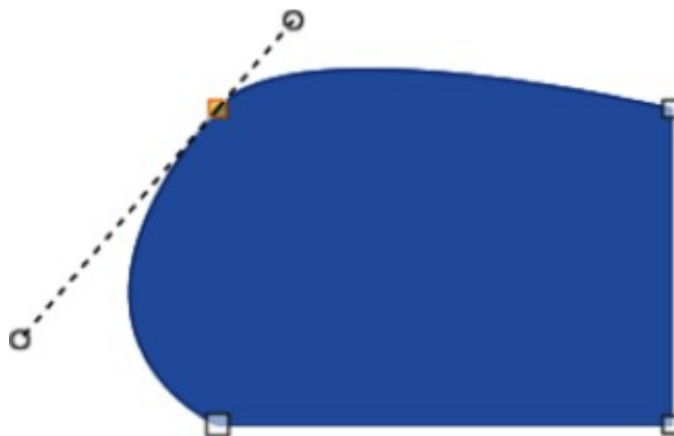

Figure 75: Example of smooth transition

- 1) Convert an object to a curve or polygon.

- 2) Switch the selected object into editing points mode and open the Edit Points toolbar.
- 3) Select the point to be changed to a symmetrical point.
- 4) Click on **Symmetric Transition** in the Edit Points toolbar. The straight line on each side of the symmetric transition point is converted to a curve.
- 5) Click and drag a tangent control handle to change the object curvature and shape. Any change to one tangent is carried over symmetrically to the other tangent.

Smooth transition

Smooth transition converts a corner or symmetrical point into a smooth point. Tangents are aligned in a straight line and move simultaneously. Tangents can have different lengths with the curvature controlled by the longest tangent which is the largest curvature, as shown in Figure 75.

- 1) Convert the object to a curve or polygon.
- 2) Switch the selected object into editing points mode and open the Edit Points toolbar.
- 3) Select the point to be changed to a symmetrical point.
- 4) Click on **Smooth Transition** on the Edit Points toolbar.
- 5) Click and drag a tangent control handle to change the object shape. This creates an asymmetric tangent with the largest curvature on the tangent longest side.

Corner point

Converts selected points into corner points. Corner points have two movable control points, which are independent from each other. It is possible to independently change the angle on each side of a tangent using the tangent central point as a corner point, as shown in Figure 76.

- 1) Convert the object to a curve or polygon.
- 2) Switch the selected object into editing points mode and open the Edit Points toolbar.
- 3) Select the point to be changed to a symmetrical point.
- 4) Click on **Corner Point** on the Edit Points toolbar.
- 5) Click and drag the end of a tangent to change its angle. Each tangent can be moved independently to create spikes and troughs in an object shape.

Points

Moving points

When moving points, the object border on both sides of the point follows the point movement changing the object shape.

- 1) Convert the object to a curve or a polygon.
- 2) Switch the selected object into editing points mode and open the Edit Points toolbar.
- 3) Select the point to be changed to a symmetrical point.
- 4) Click on **Move Points** on the Edit Points toolbar.

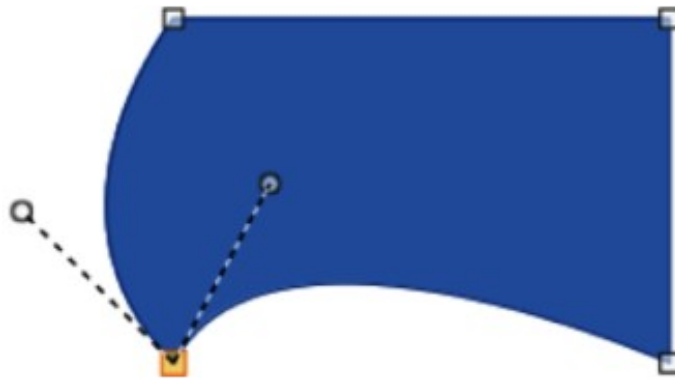

Figure 76: Example of changing corner point

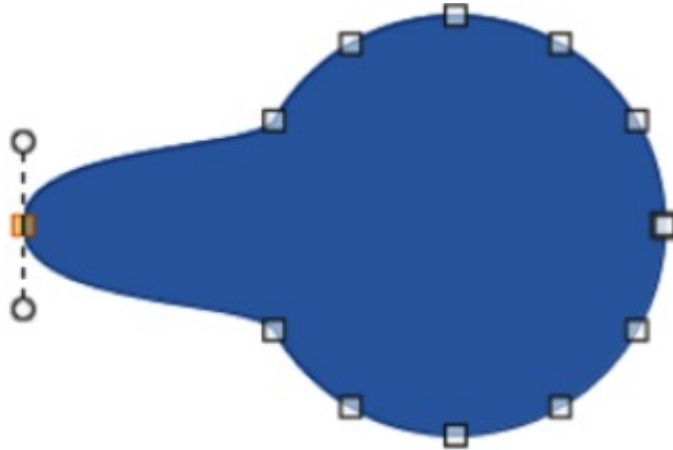

Figure 77: Example of moving points



Figure 78: Example of inserting points

- 5) Place the cursor on the selected point, then click and drag the point to create a new shape. Figure 77 illustrates how a different shape can be created from a circle by dragging the left hand side point to the left.

Inserting points

A point is inserted into a selected object each time there is a click. Clicking inside the object border, the object changes shape to include the new point into the object border, as shown in Figure 78. The inserted point is a smooth point.

Points can also be moved in insert point mode. Hover the cursor over the point until it changes shape, then click and drag the point to change the object shape.

- 1) Convert the object to a curve or a polygon.
- 2) Switch the selected object into editing points mode and open the Edit Points toolbar.
- 3) Click on **Insert Points** on the Edit Points toolbar.
- 4) Click on the object border to insert a point at the required position on the border.
- 5) Alternatively, click inside the object border to insert a point. The object automatically changes shape to include the new point into the object border.

Deleting points

Figure 79 shows what happens when three points on the left were deleted from a circle. The left image is a the full circle and the right image is where three points have been deleted creating a new shape.

- 1) Convert the object to a curve or a polygon.
- 2) Switch the selected object into editing points mode and open the Edit Points toolbar.
- 3) To delete a single point, proceed as follows
 - a) Select the point for deletion.
 - b) Click on **Delete Points** on the Edit Points toolbar.
- 4) To delete several points at the same time, proceed as follows:
 - a) Hold down the *Shift* key.
 - b) Select all the points for deletion.
 - c) Click on **Delete Points** on the Edit Points toolbar.

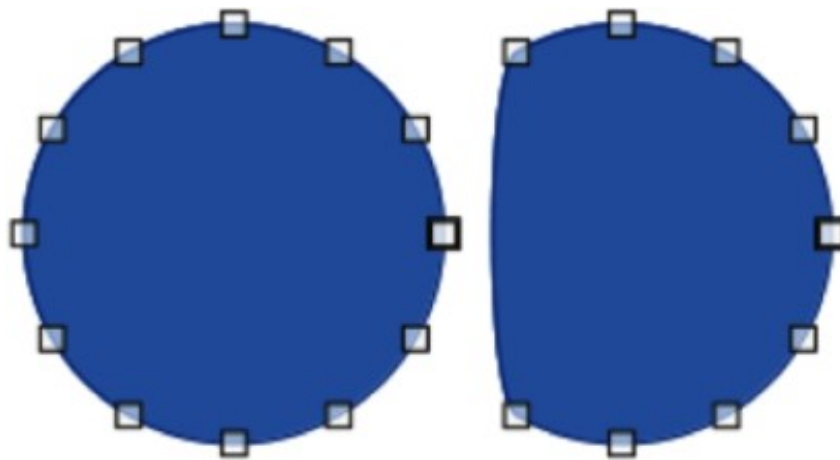

Figure 79: Example of deleting points

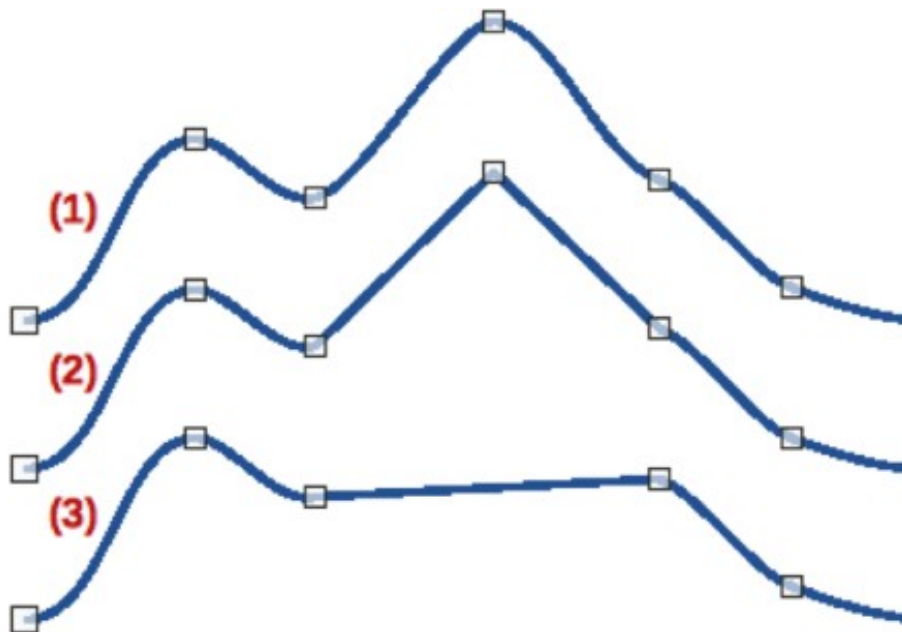

Figure 80: Example of converting a curve into a line

- 1) Curve with points displayed.
- 2) Sections between points converted to line.
- 3) Point deleted to create a line section.

Eliminating points

The **Eliminate Points** tool on the Edit Points toolbar only functions on lines with multiple points. These lines are created when a curve is converted to a line using the **Convert to Curve** tool. An example of creating a straight line and eliminating points is shown in Figure 80.

- 1) Convert the curve to a curve or a polygon.
- 2) Switch the curve into editing points mode and open the Edit Points toolbar.
- 3) Select the curve with multiple points and convert to a line, see “Converting curves or lines” below.
- 4) Select the point or points on the line for elimination. The selected point is emphasized.
- 5) Select the **Eliminate Points** tool on the Edit Points toolbar.
- 6) Accurately position the cursor over the selected point, then click and drag the selected point. As the cursor is dragged, a dotted line forms between the neighboring points.
- 7) When this dotted line appears to be a straight line between the neighboring points, release the click. The selected point is eliminated and a straight line now exists between the neighboring points.

Converting curves or lines

Curves and lines are converted using the **Convert to Curve** tool on the Edit Points toolbar. When a curve is converted to a line, a straight line is created between selected points on a curve. When a line is converted to a curve, a curve is created between selected points on a line. An example of converting a curve to a line is shown in Figure 80.

- 1) Convert the object to a curve or a polygon.
- 2) Switch the object into editing points mode and open the Edit Points toolbar.
- 3) Select the points for converting from curve to line or from line to curve.

- 4) Click on **Convert to Curve** on the Edit Points toolbar. Between the selected points, a curve is converted into a line or a line is converted into a curve.
- 5) Delete a point on the converted line to create a straight line.

Splitting objects

- 1) Convert the object to a curve or a polygon.
- 2) Switch the object into editing points mode and open the Edit Points toolbar.
- 3) Select the point or points on the object where it is to be split. Keep the *Shift* key pressed down when selecting more than one point.
- 4) Click on **Split Curve** on the Edit Points toolbar to split or cut the object border at the selected point. If the object is filled, it will be emptied because the object border is no longer closed, as shown in Figure 81.
- 5) Deselect the object, then drag the cut segment and move it away from the original object.

✓ Note

The point where the object was split is now larger than the remaining points visible on the object.

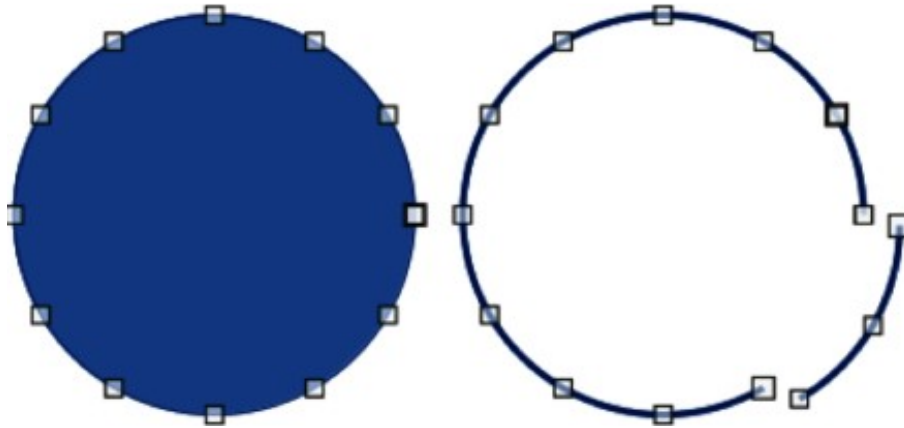

Figure 81: Example of splitting objects

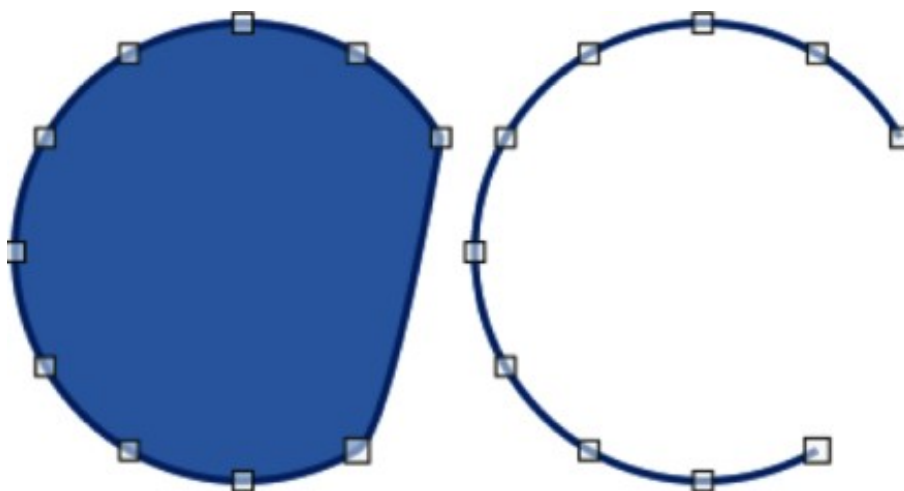

Figure 82: Example of closing objects

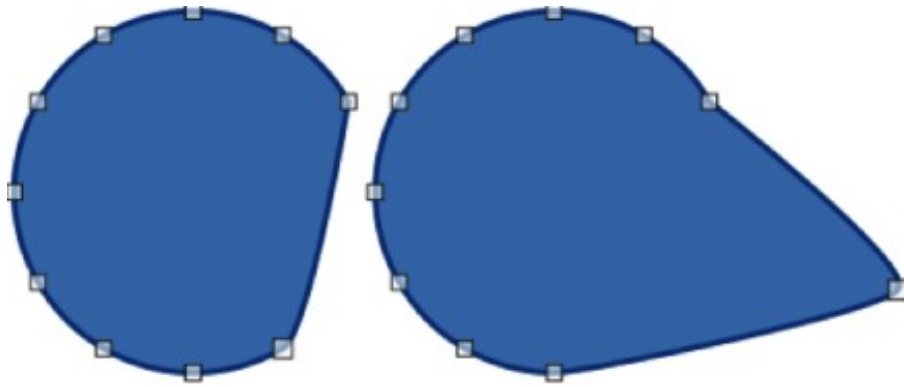

Figure 83: Example of distorting objects

Closing objects

- 1) Select an open object (Figure 82).
- 2) Switch the object into editing points mode and open the Edit Points toolbar.
- 3) Select a point where the object has been split. Note that the start point of an object is larger than the other points visible on the object.
- 4) Click on **Close Bézier** in the Edit Points toolbar to close the object. If the open object was originally a closed and filled object, then the original color fills the object when it is closed.

Distorting objects

- 1) Select the object and switch into editing points mode to display the points on the object. This also opens the Edit Points toolbar.
- 2) Select a point on the object and drag it to a new position to distort the object (Figure 83).



LibreOffice
Community



Draw Guide 7.5

Chapter 4, Changing Object Attributes

Formatting lines

In LibreOffice the term *Line* indicates a freestanding segment (line), the outer edge or border of a shape, or an arrow. The properties of a line that can be modified are style (solid, dashed, invisible, and so on), width, color and type of arrowhead.

Tip

Hovering the cursor over a tool icon on a toolbar, or in the Sidebar, a pop up displays the name of the tool.

Note

For more information on using color when formatting lines, line styles, arrows, and arrow styles, see “Working with area fills” on page 91.

Line and Filling toolbar

- 1) Select line in the drawing.
- 2) If necessary, go to **View > Toolbars** on the Menu bar and select **Line and Filling** from the drop-down list to open the Line and Filling toolbar (Figure 84):
- 3) Click on the triangle ▼ to the right of **Line Style** and select a line style from one of the options in the drop-down list.
- 4) Either type the line width in the **Line Width** text box, or use the up and down arrows to change the line width.
- 5) Click on the triangle ▼ to the right of **Line Color** and select a color from one of the available color palettes.
- 6) If necessary, click on **Shadow** to add a shadow to the line. The shadow applied uses the settings set in the Line dialog (Figure 106 on page 108).
- 7) If necessary, select from the **Select start and end arrowheads for lines** drop-down list the arrowhead type for each end of the line and change the line into an arrow. The left drop-down list adds an arrow head to the beginning of the line. The right drop-down list adds an arrow head to the end of the line.
- 8) Deselect the line to save the changes to the line.

Sidebar

- 1) Select a line in the drawing.
- 2) Click on **Properties** on the Sidebar to open the Properties deck.

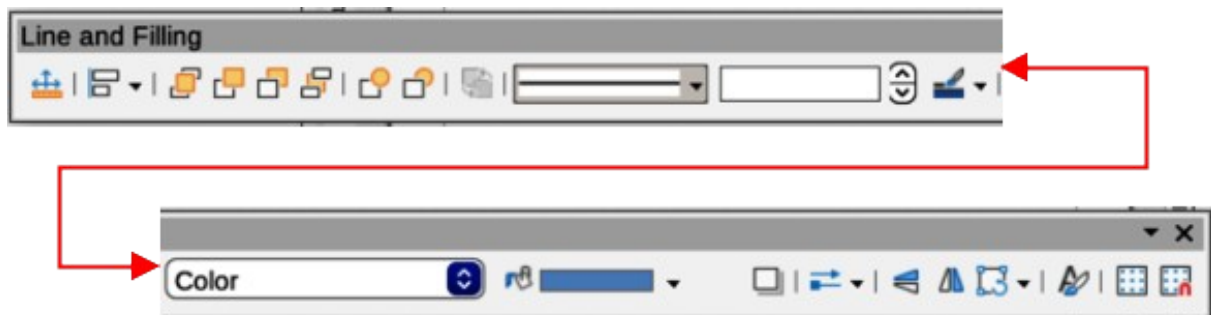

Figure 84: Line and Filling toolbar

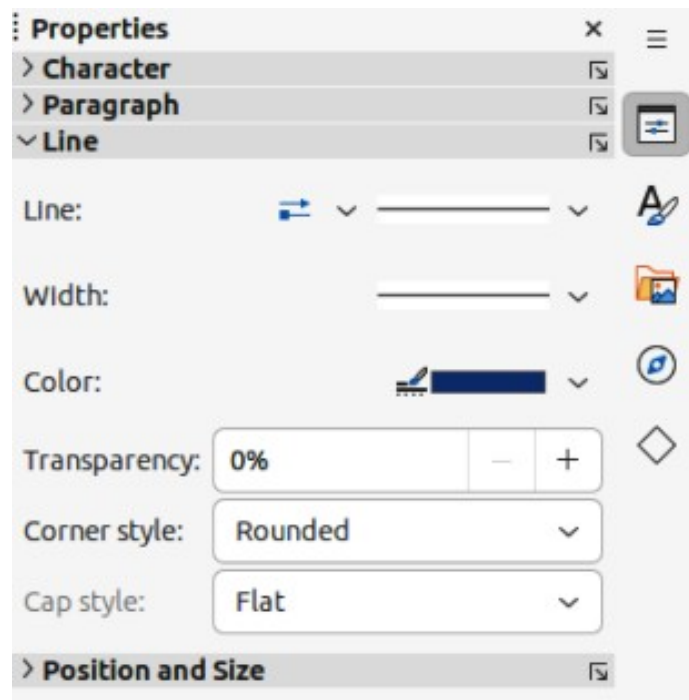

Figure 85: Line panel in Properties deck on Sidebar

- 3) Click on **Line** to open the **Line** panel (Figure 85).
- 4) If required, in *Line* click on **Select start and end arrowheads for lines** to open the drop-down lists for arrowhead types for each end of the line and change the line into an arrow. The left drop-down list adds an arrowhead to the beginning of the line. The right drop-down list adds an arrowhead to the end of the line.
- 5) In *Line*, select the type of line required from the **Line Style** drop-down list.
- 6) In *Width*, select a line width from the options available in the *Width* drop-down list, or enter a width in the **Custom Line Width** text box.
- 7) In *Color*, click on the triangle ▼ to the right of **Line Color** and select a color from one of the available color palettes.
- 8) If required, in *Transparency* enter a percentage amount for line transparency.
- 9) If required, in *Corner style* select a corner style for the line from the drop-down list.
- 10) If required, in *Cap style* select a cap style for line ends from the drop-down list.
- 11) Deselect the line to save changes made to the line.
- 12) If necessary, click on **More Options** on the right of the title bar and open the Line dialog for more control over formatting lines.

Line dialog

- 1) Make sure a line is selected on a drawing.
- 2) Open the Line dialog (Figure 86) using one of the following methods:
 - Go to **Format > Line** on the Menu bar.
 - Right-click on the line and select **Line** from the context menu.
 - Click on **More Options** on the right of the **Line** panel title on the Sidebar.

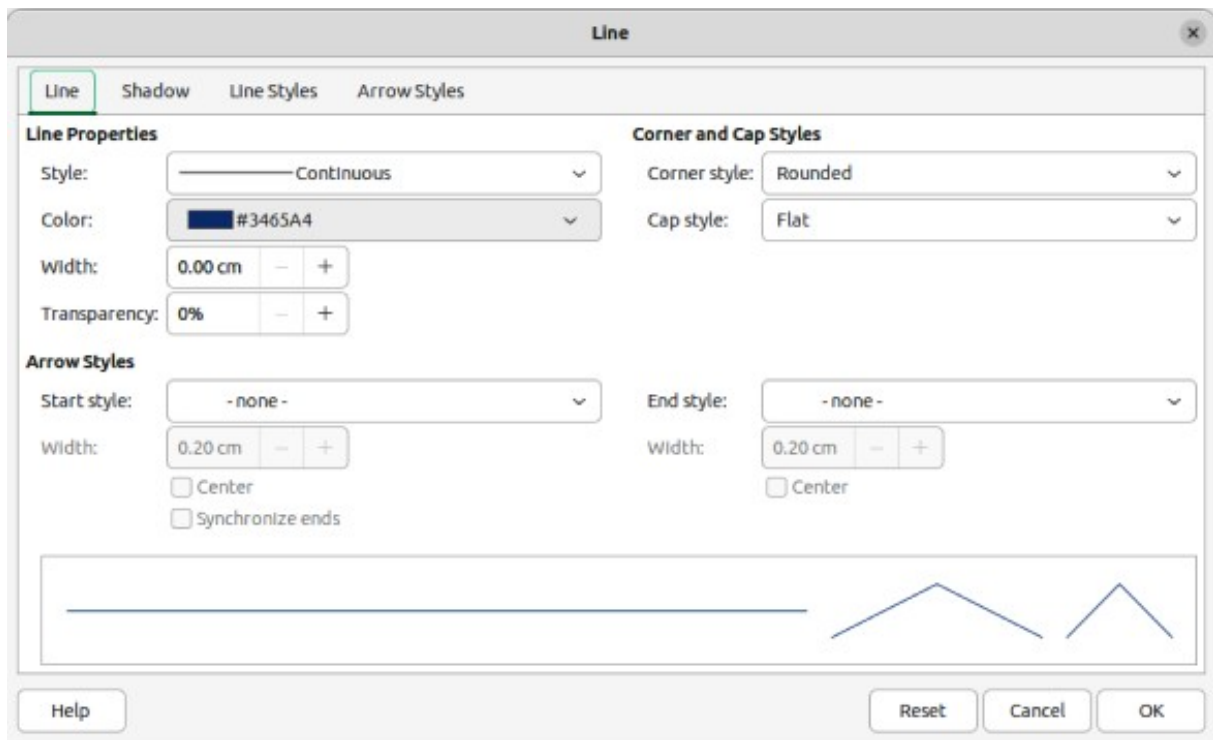

Figure 86: Line dialog — Line page

- 3) Format the line using the options available in the Line dialog. A preview box at the bottom of the dialog shows the effect of the changes on a line.
- 4) Click **OK** to save the changes and close the dialog.

Line properties

The **Line** page in the Line dialog is where the basic parameters of the line are set. It is divided into three sections as follows.

Line properties

Style

Select a line style from the drop-down list.

Color

Select a predefined color from one of the available color palettes.

Width

Specifies the thickness of the line.

Transparency

Sets the transparency of a line. Figure 87 shows the effects of different percentages in transparency levels to lines when placed over an object.

Arrow Styles

This section is only applicable to individual lines and is not used for lines that form the borders of an object.

Start style

Select from the drop-down list an arrow style or arrowhead for the start of a line.

End style

Select from the drop-down list an arrow style or arrowhead for the end of a line.

Width

Specifies the thickness of the arrow endings.

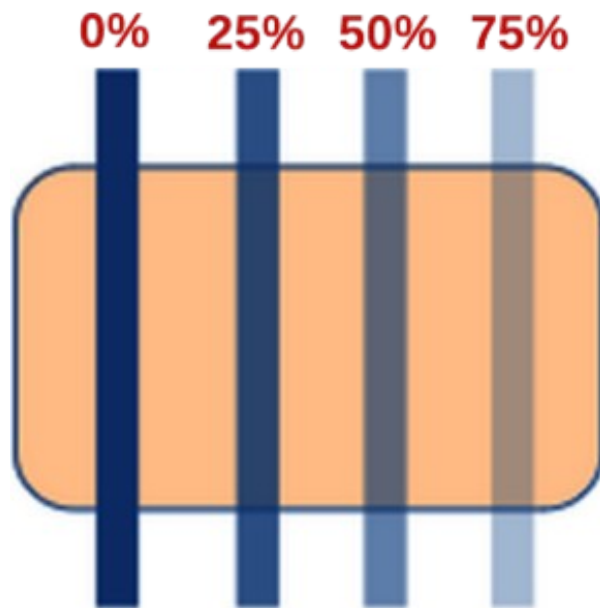

Figure 87: Example of line transparencies



Figure 88: Example of arrow endings

- 1) Default ending
- 2) Centered ending

Center

Moves the center of the arrow endings to the end point of the line. Figure 88 shows the effects of selecting this option.

Synchronize ends

Makes the two line ends identical.

Corner and Cap Styles

Determines how the connection between two segments of a line looks. To appreciate the difference between these styles, choose a thick line style and observe how the preview changes.

Corner style

Select the shape to be used at the corners of the line. For a small angle between lines, a mitered shape is replaced with a beveled shape.

Cap style

Select the style of the line end caps. The caps are added to inner dashes as well.

Line shadows

The **Shadow** page (Figure 89) of the Line dialog provides options to add and format a shadow to a selected line. The settings on this dialog page are the same as those for shadows applied to other objects, described in “Working with shadows” on page 107.

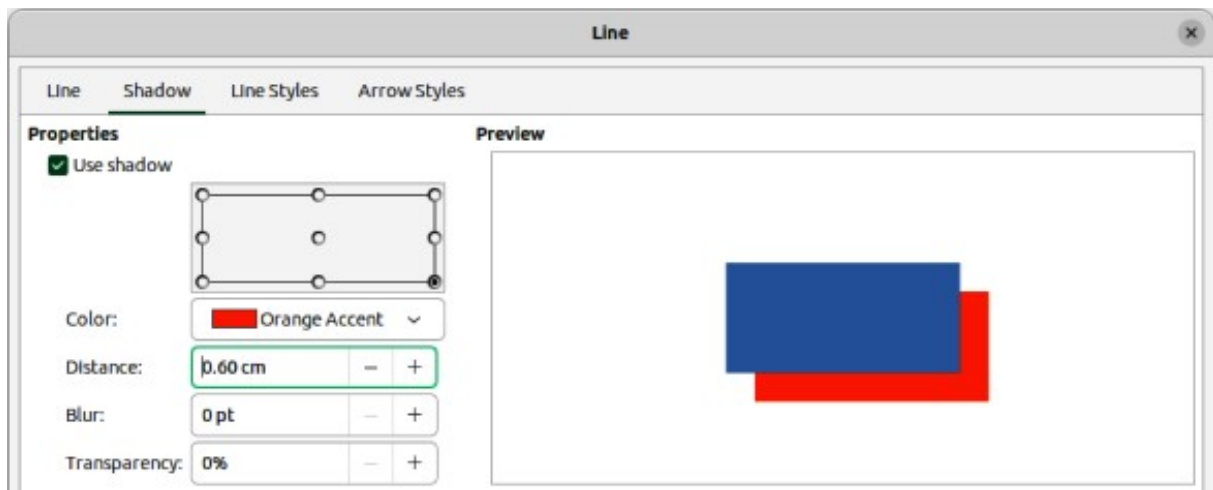

Figure 89: Line dialog — Shadow page

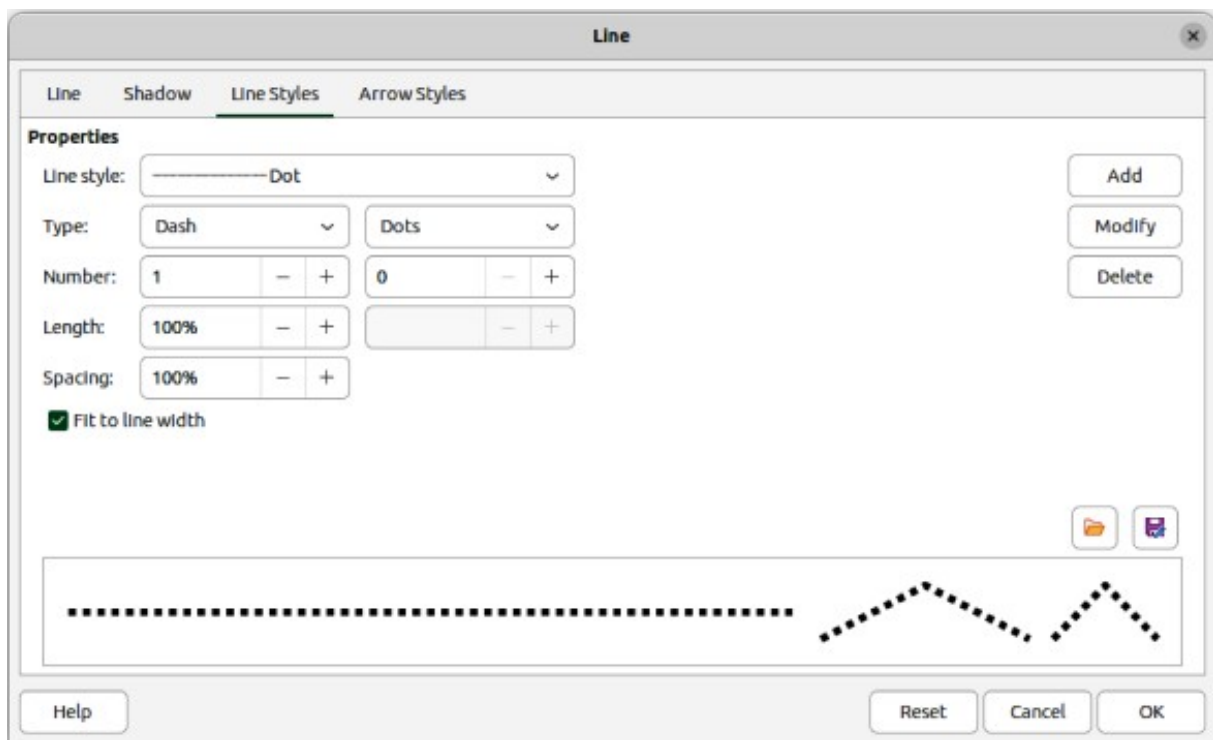

Figure 90: Line dialog — Line Styles page

To quickly apply a shadow to a line, click on **Shadow** on the Line and Filling toolbar. This creates a shadow using the settings from the **Shadow** page in the Line dialog.

Line styles

When adding several lines using the same format, line styles reduce the need to format individual lines. LibreOffice includes line styles that can be used in a drawing. Also, line styles can be created, saved, and deleted. The **Line Styles** page in the Line dialog (Figure 90) provides options to use predefined line styles and to create or change line styles.

Creating line styles

- 1) Create a line in a drawing.
- 2) Open the Line dialog using one of the following methods:
 - Go to **Format > Line** on the Menu bar.

- Right-click on the line and select **Line** from the context menu.
- 3) Click on the **Line Styles** tab in the Line dialog to open the **Line Styles** page.
 - 4) In the *Line style* drop-down list, select a pre-defined line style similar to the style to be created. An example of the line style selected is displayed at the bottom of the dialog page. This example changes as changes are made to the line style.
 - 5) In the *Type* drop-down menus, select either **Dots** or **Dash**.
 - For one type for the line, select the same type in both *Type* boxes.
 - To alternate two line types within a single line, select different types in both *Type* boxes.
 - 6) In the *Number* boxes, specify the number of dots or dashes selected in *Type*. For different sized groups of dots or dashes, set a different quantity in each *Number* box.
 - 7) In the *Length* boxes, specify the **Dash** length as a percentage of the line. The *Length* option is not available for **Dots**.
 - 8) In the *Spacing* box, specify the spacing between the dashes and/or dots as a percentage of the line. The *Spacing* option is not available when the option *Fit to line width* is selected.
 - 9) If necessary, select *Fit to line width* so that the new style fits the line width when used in a drawing.
 - 10) For the current document only, create a new line style, or modify a line style as follows:
 - a) Click on **Add** or **Modify** to open the Name dialog.
 - b) Enter a unique name for the new or modified line style.
 - c) Click on **OK** to save the new or modified line style and close the Name dialog.
 - 11) Click on **OK** to close the Line dialog and the new line style is ready for use in the current drawing only.



Notes

To use the new or modified line style in other drawings, the line style must be saved using **Save Line Styles**. See "Saving line styles" below for more information.

When creating or modifying a line style, it is recommended to use a unique name for the line style. This prevents one of the LibreOffice line styles from being overwritten and causing formatting problems in other drawings or documents that use LibreOffice line styles.

Saving line styles

- 1) Create a new line style, described in "Creating line styles" above, but do not close the Line dialog.
- 2) Click on **Save Line Styles** at the bottom right of the **Line Styles** page to open a file browser window at the correct location for line styles.
- 3) Enter a unique filename using the file extension SOD for the line style in the *Name* box.
- 4) Click on **Save** to save the line style and close the file browser window. The new line style is now available for use in new drawings and documents.

Importing line styles

LibreOffice line styles are available when LibreOffice is installed on a computer. However, compatible line styles can be imported and used in LibreOffice. Any line styles loaded into LibreOffice must use the file extension SOD.

- 1) Create a line in a drawing.
- 2) Open the Line dialog and click on the **Line Styles** tab to open the **Line Styles** page.
- 3) Click on **Load Line Styles** at the bottom right of the **Line Styles** page to open a file browser window at the correct location for line styles.
- 4) Select a style from the list of saved styles in the file browser window. The file extension for line styles is SOD.
- 5) Click **Open** to load the line style into LibreOffice. The line style becomes available for other LibreOffice drawings and documents.
- 6) Click **OK** to close the Line dialog and save any changes made.

Deleting line styles

- 1) Open the Line dialog and click on the **Line Styles** tab to open the **Line Styles** page.
- 2) Select the line style for deletion from the *Line style* drop-down list.
- 3) Click on **Delete** and confirm the deletion by clicking on **Yes** in the confirmation dialog.
- 4) Click **OK** to close the Line dialog and save any changes made.

Note

When deleting line styles, make sure the line style has not been used in another document. It is recommended to only delete line styles that have been created, or imported, and do not delete one of the LibreOffice predefined line styles. This prevents any formatting problems in other documents where the line style has been used.

Arrow styles

Use the **Arrow Styles** page (Figure 91) in the Line dialog to create new arrow styles, modify existing arrow styles, or load previously saved arrow styles.

Creating arrow styles

Any shape can be used as an arrowhead, but the shape must be convertible to a curve. A curve is something drawn without lifting a pencil. For example, a star can be converted to a curve, but a smiley face cannot.

Note

The part of the shape being used as the point in an arrowhead must be at the top of the shape when creating a new arrowhead. If necessary, rotate the shape until the point is at the top of the shape.

- 1) Select a shape, or create a shape that can be converted to a curve for use as a new arrowhead. The part of the shape that is going to be point of the arrowhead must face upward. An example of a new arrowhead is shown in Figure 92.

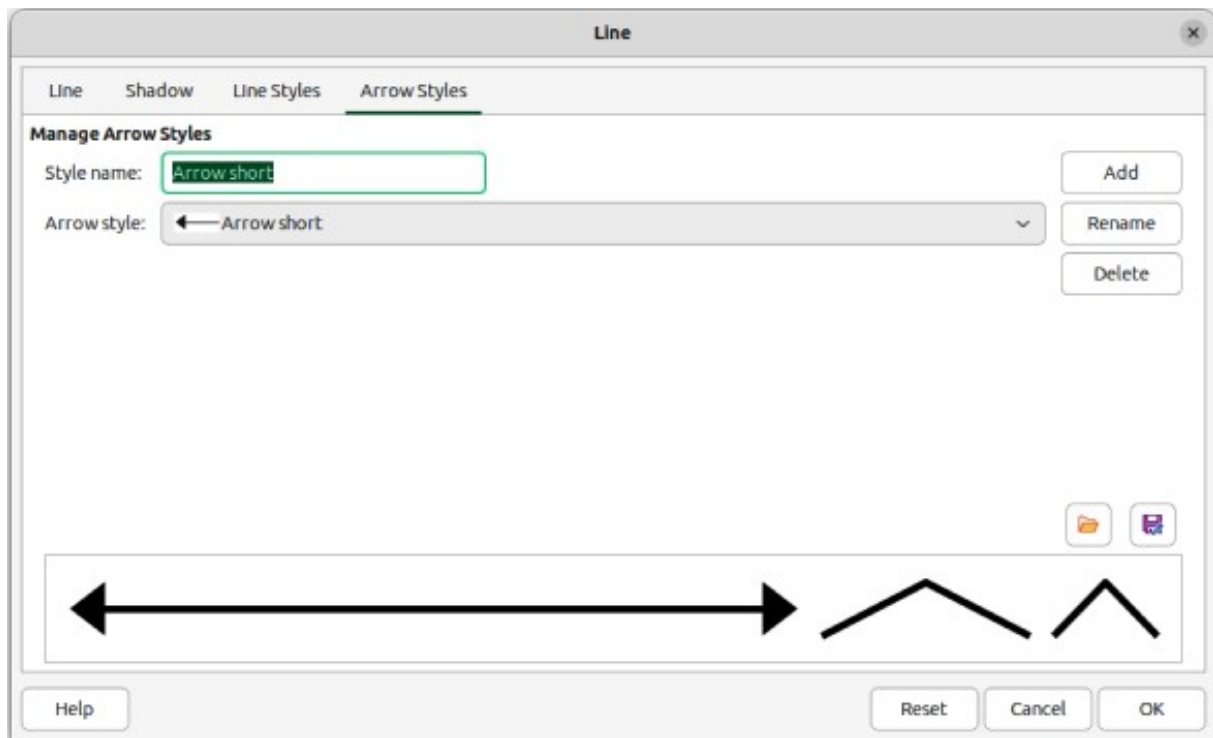

Figure 91: Line dialog — Arrow Styles page



Figure 92: Example of a created arrowhead

- 2) Select the shape and convert to a curve using one of the following methods:
 - Right-click on the shape and select **Convert > To Curve** from the context menu.
 - Go to **Shape > Convert > To Curve** on the Menu bar.
- 3) With the shape selected, open the **Arrow Styles** page in the Line dialog.
- 4) Click on **Add** and type a unique name for the new arrow style in the Name dialog that opens, then click **OK**. The new arrowhead style is displayed in the preview box of the Line dialog and at the bottom of the *Arrow style* drop-down list.
- 5) Click **OK** to save the changes and close the Line dialog. The new arrow style is available only in the current document.

✓ Note

Some shapes cannot be used as an arrowhead. This is indicated by rectangular blocks appearing at each end of the line in the preview box on the **Line Styles** page in the Line dialog.

When creating an arrow style, it is recommended to use a unique name for the arrow style. This prevents one of the standard arrow styles in LibreOffice from being overwritten and causing formatting problems in other drawings that use the standard arrow styles.

The new arrow style created is available only for use in the current drawing. To use the new arrow style in other drawings, the arrow style must be saved using the **Save Arrow Styles** option.

Saving arrow styles

- 1) Create a new arrow style as described in “Creating arrow styles” on page 86, but do not close the Line dialog.
- 2) Click on **Save arrow styles** at the bottom right of the **Arrow Styles** page to open a file browser window at the correct location for arrow styles.
- 3) Enter a unique filename using the file extension SOE for the arrow style.
- 4) Click on **Save** to save the arrow style and close the file browser window. The new arrow style is now available for use in new documents.

Importing arrow styles

LibreOffice provides standard arrow styles when installed on a computer. However, compatible arrow styles can be loaded and used in LibreOffice. Any arrow styles loaded into LibreOffice must use the file extension SOE.

- 1) Open the Line dialog and click on the **Arrow Styles** tab to open the **Arrow Styles** page.
- 2) Click on **Load arrow styles** at the bottom right of the **Arrow Styles** page to open a file browser window at the correct location for arrow styles.
- 3) Select an arrow style from the list of saved styles in the file browser window
- 4) Click **Open** to load the arrow style into the drawing. The arrow style also becomes available for other LibreOffice documents.
- 5) Click **OK** to close the Line dialog and save any changes made.

Deleting arrow styles

- 1) Open the Line dialog and click on the **Arrow Styles** tab to open the **Arrow Styles** page.
- 2) Select the arrow style for deletion from the *Arrow style* drop-down list.
- 3) Click on **Delete** and confirm the deletion by clicking on **Yes** in the confirmation dialog that opens.
- 4) Click **OK** to close the Line dialog and save any changes made.

✓ Note

When deleting arrow styles, make sure the arrow style is not used in another document. It is recommended to only delete arrow styles that have been created, or imported, and not to delete one of the LibreOffice predefined arrow styles. This prevents formatting problems in other documents using LibreOffice arrow styles.

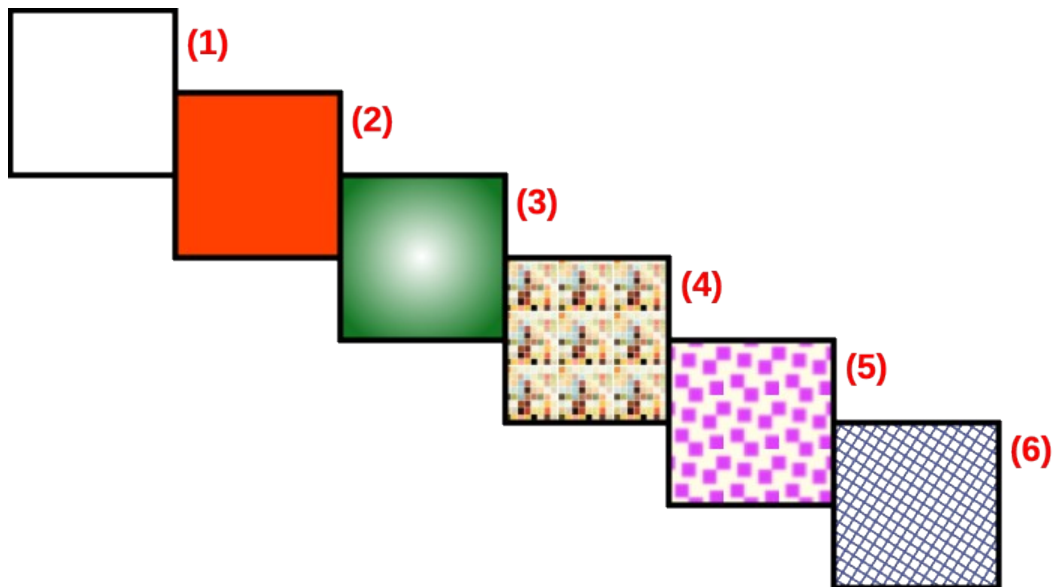

Figure 93: Examples of area fill types

- | | | |
|----------|--------------------|----------------------|
| 1) None | 3) Gradient | 5) Pattern |
| 2) Color | 4) Image or Bitmap | 6) Hatch or Hatching |

Area fills

Area fill refers to the inside of an object that has an unbroken border, for example a rectangle, circle, star, pentagon and so on. An area fill can be none, color, gradient, image/bitmap, pattern, or hatch/hatch, as shown by the examples in Figure 93. Also, an area fill can be partly or wholly transparent and throw a shadow.

The Area dialog provides tools and options for selecting and editing area fills. Area fills are also available in drop-lists in the **Area** panel in the Properties deck on the Sidebar and in **Area Style/Filling** on the Line and Filling toolbar, but have reduced options and different fill types.

Area dialog formatting

- 1) Make sure the object is selected in a drawing.
- 2) Open the Area dialog (Figure 94) using one of the following methods:
 - Go to **Format > Area** on the Menu bar.
 - Click on **Area** in the Line and Filling toolbar.
 - Right-click on the selected object and select **Area** from the context menu.
 - Click on **More Options** on the right of the Area section title on the Sidebar.
- 3) Click on the **Area** tab to open the **Area** page.
- 4) Select the type of area fill from the available options (*None, Color, Gradient, Image, Pattern, or Hatch*).
- 5) Select the required area fill options that become available for each type of area fill selected.
- 6) Click **OK** to close the Area dialog and save the changes to the area fill.



Figure 94: Area dialog — Color page

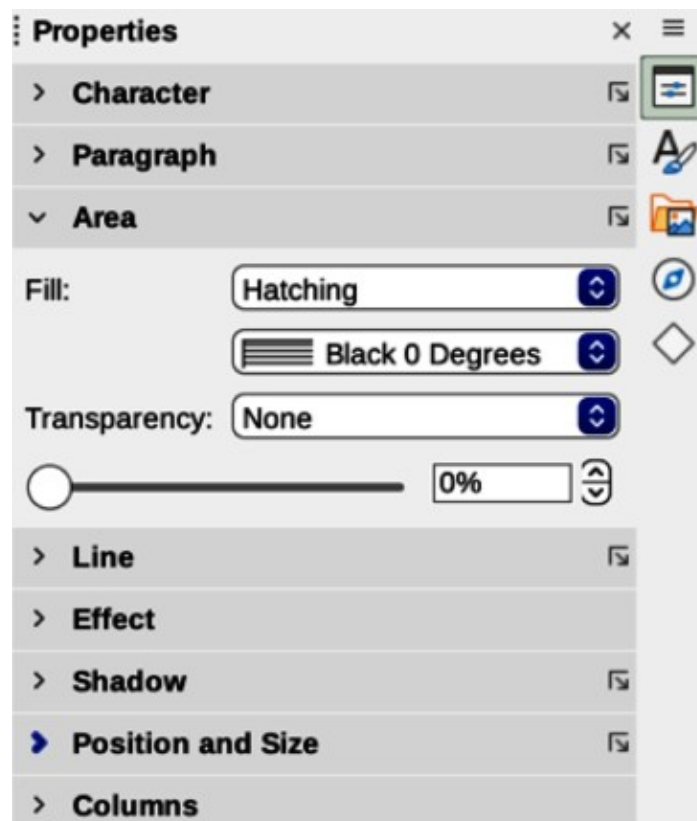

Figure 95: Area panel in Properties deck on Sidebar

Sidebar formatting

- 1) Make sure an object with an area fill is selected in a drawing.
- 2) Click on **Properties** on the Sidebar, then click on the down chevron **v** on the left of the **Area** titlebar to open the **Area** panel (Figure 95).
- 3) Select a fill type (*None, Color, Gradient, Hatching, Bitmap, or Pattern*) from the *Fill* drop-down list.
- 4) Select a fill effect from the options available for each fill type from the *Fill* drop-down list.

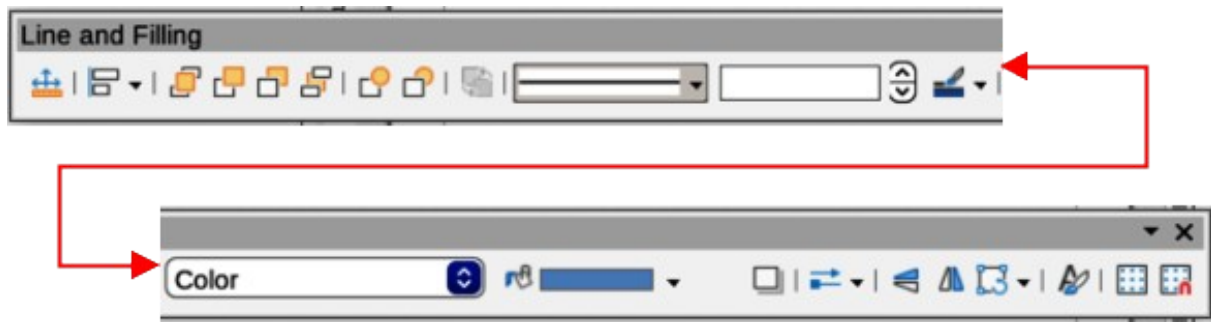

Figure 96: Line and Filling toolbar

- 5) If required, select a transparency type and a transparency percentage from the *Transparency* drop-down lists.
- 6) Deselect the object to save the changes to the area fill.

✓ Note

The type of transparency effect selected for an area fill changes the options available for a transparency in the **Area** panel on the Sidebar.

Line and Filling toolbar formatting

- 1) If Line and Filling toolbar (Figure 96) is not open, go to **View > Toolbars > Line and Filling** on the Menu bar.
- 2) Select an object so that the selection handles are displayed.
- 3) Select a fill type (*None, Color, Gradient, Hatching, Bitmap, or Pattern*) from the *Area Style/Filling* drop-down list.
- 4) Select a fill effect from the options available for each fill type from the *Select the effect to apply* drop-down list.
- 5) Deselect the object to save the changes to the area fill.

Working with area fills

The following instructions on area fills use the Area dialog as the main method of selecting and editing an area fill. The tools and options available in the **Area** panel in the Properties deck on the Sidebar and on the Line and Filling toolbar are similar, but have reduced options and different names.

Color fills

The following procedures to select and format colors for area fills uses the Area dialog. Using the tools on the Line and Filling Toolbar and the **Area** panel in the Properties deck on the Sidebar is similar, but have fewer options available.

Selecting color fill

- 1) Make sure the object is selected in a drawing.
- 2) Open the **Area** page on the Area dialog (Figure 94 on page 90), then click on **Color** to open the options available for a color fill.
- 3) In **Colors**, select the required palette from the available options in the *Palette* drop-down list.

- 4) Click on the color required in the selected palette. All color fills available are solid colors. The **Active** preview box shows the present color fill of a selected object. After selecting a color, a preview of the selected color appears in the **New** preview box.
- 5) Alternatively, use one of the following methods to select a color.
 - Enter the *RGB* values on a 0 to 255 scale, or *Hex* number of a color in the appropriate text box.
 - If a color has been used before, then select the required color from the colors available in *Recent Colors*.
- 6) To revert back to the original color, click on **Reset** and any changes made are removed.
- 7) Click **OK** to close the Area dialog and save the changes. The color area fill is then changed in the selected object.

Creating custom colors using Area dialog

- 1) Select a filled object to create a color.
- 2) Open the Area dialog and click on **Area** to open the **Area** page, then click on **Color** to open the options available for a color fill.
- 3) Create a custom color using one of the following methods:
 - Specify the values of Red (R), Green (G), and Blue (B) on a 0 to 255 scale.
 - Click on **Pick** to open the Pick a Color dialog (Figure 97), see “Creating custom colors using Pick a Color dialog” below.
- 4) Click on **Add** in *Custom Palette* and enter a name for the color in the Name dialog that opens.
- 5) Click **OK** to close the Name dialog and the color is added to the *Custom* palette.
- 6) Click **OK** to close the Area dialog and save the changes. The new custom color appears as a fill in the selected object and is available for use in other drawings or documents.

Creating custom colors using Pick a Color dialog

- 1) Select a filled object to create a color.
- 2) Open the Pick a Color dialog (Figure 97) using one of the following methods:
 - Click on **Pick** on the Colors page of the Area dialog.
 - Click on the triangle ▼ next to **Fill Color** in the *Area* panel of the Properties deck on the Sidebar and select *Custom Color*.
 - Click on the triangle ▼ next to **Fill Color** on the Line and Filling toolbar and select *Custom Color*.
- 3) Create a custom color using one of the following methods. A preview of the color being created is shown on the left side of the original color box below the color selection box.
 - Select a color range from the colored bar, then, using the cursor, move the target in the colored box until the cursor is on the color required.
 - Enter values for *Red* (R), *Green* (G), and *Blue* (B) in the **RGB** text boxes.
 - Alternatively, if known, enter the *Hex#* number in the text box. Hex numbers are normally used when a specific color has been created for a company logo or company name.

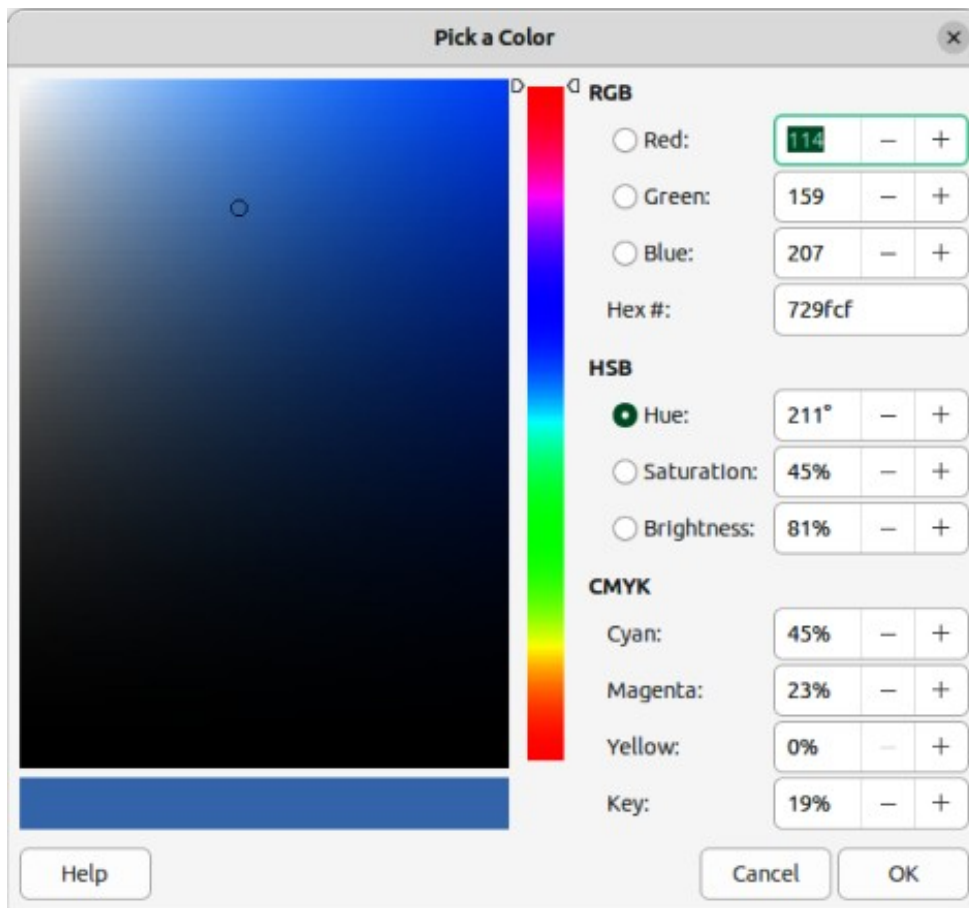

Figure 97: Pick a Color dialog

- Alternatively, enter values for *Hue* (H), *Saturation* (S), and *Brightness* (B) in the **HSB** text boxes. HSB values do not change the color, but how a color looks.
- Alternatively, enter values for *Cyan* (C), *Magenta* (M), *Yellow* (Y), and *Key* (K) (black) in the **CMYK** text boxes.

✓ Note

Changing one set of color values also changes the color values in the other sets of color values.

- 4) Click **OK** to close the Pick a Color dialog and save the changes.
- 5) Click on **Add** in *Custom Palette* and enter a name for the color in the Name dialog that opens.
- 6) Click **OK** to close the Name dialog and the color is added to the *Custom palette*.
- 7) Click **OK** to save the changes and close the Area dialog. The new color appears as a fill in the selected object and is available for use in other drawings or documents.

Deleting custom colors

- 1) Select a filled object that uses the color fill for deletion.
- 2) Open the Area dialog using one of the following methods:
 - Go to **Format > Area** on the Menu bar.
 - Right-click on the object and select **Area** from the context menu.

- Click on **More Options** on the right of the Area section title on the Sidebar.
- 3) Click on **Area**, then click on **Colors** to open the Colors page.
 - 4) In **Colors**, select **Custom** from the *Palette* drop-down list.
 - 5) Select the color for deletion and click on **Delete**. There is no confirmation given when deleting a color.
 - 6) Click **OK** to save the changes and close the Area dialog.

✓ Note

Only custom colors available in the custom palette can be deleted using the Area dialog. Colors that are available in LibreOffice color palettes cannot be deleted.

Gradient fills

Several predefined gradients are included when LibreOffice is installed. It is recommended to create custom gradients that match the requirements rather than modifying the installed predefined gradients. Predefined gradients may have been used in other objects in a drawing or other documents.

Custom gradients are saved with a unique name allowing the custom gradient to be used in other drawings or documents. Custom gradients are placed at the end of the gradients displayed in the *Gradient* box on the **Gradient** page of the Area dialog (Figure 98).

Selecting gradient fills

The following procedure to select a gradient for an area fill uses the Area dialog. Using the tools on the Line and Filling Toolbar, and the **Area** panel in the Properties deck on the Sidebar is a similar procedure, but the available options are reduced.

- 1) Make sure the object to be filled is selected in a drawing.

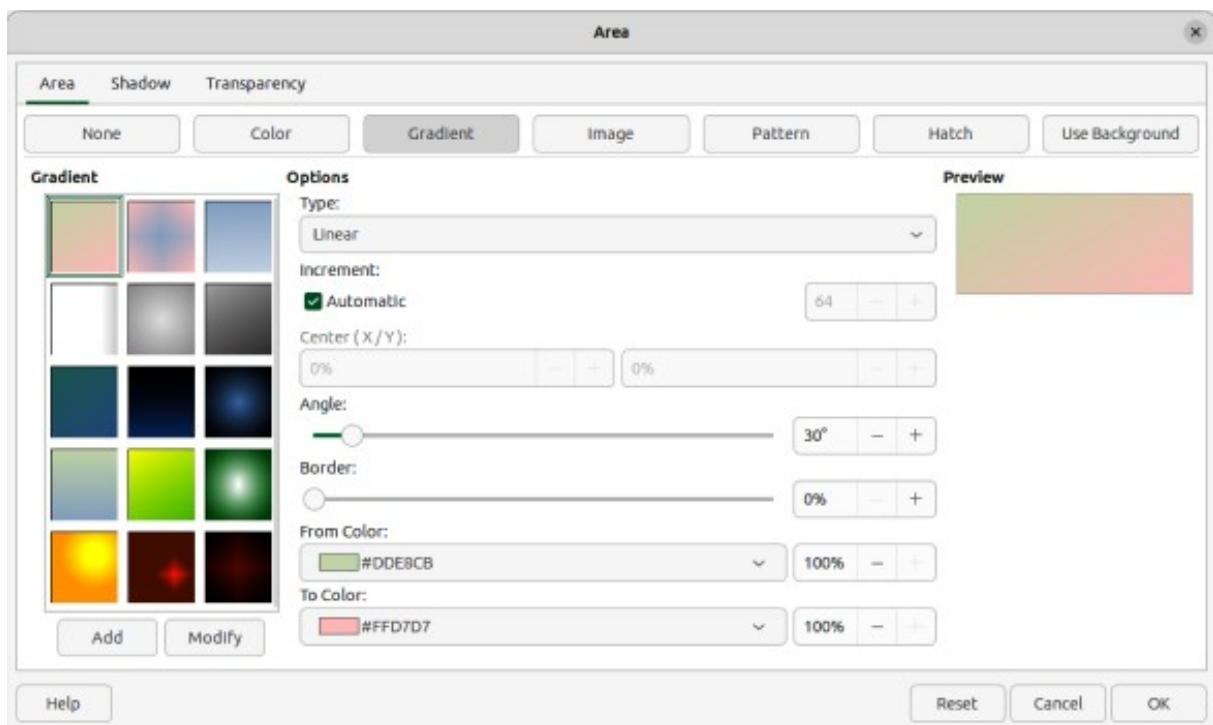

Figure 98: Area dialog — Gradient page

- 2) Open the Area dialog and click on **Area** to open the **Area** page, then click on **Gradient** to open the options available for a gradient fill.
- 3) In **Gradient**, select the required gradient from the list of available gradients and the gradient appears in **Preview**.
- 4) To override the default gradient transition of a selection, deselect *Automatic* in **Options** and then enter the values for *Type*, *Increment*, *Center*, *Angle*, *Border*, *From Color* and *To Color* to modify the gradient to the requirements. As changes are made, the gradient displayed in **Preview** also changes indicating how the gradient will look. For more information on gradient options, see “Table 3: Gradient options” below.
- 5) Click **OK** to close the Area dialog and save the changes. The gradient area fill then appears in the selected object.

 **Note**

Selecting and modifying a gradient using the above method only allows the gradient to be used in the drawing being created. If a modified gradient is to be used in other drawings or documents, then create a custom gradient and save it with a unique name. See “Creating custom gradients” below.

Table 3: Gradient options

Gradient property	Meaning
Linear gradient	The color transitions from the starting color to the end color in a straight line.
Axial gradient	The color transitions from the starting color to the end color from the object center to the object edges in two opposite directions.
Radial gradient	The color transitions from the starting color to the end color in a circular pattern.
Ellipsoid gradient	The color transitions from the starting color to the end color in an elliptical pattern.
Quadratic gradient	The color transitions from the starting color to the end color from the object edges to the object center in four directions.
Square gradient	The color transitions from the starting color to the end color from the object edges to the object center in a square pattern.
Increment	Enter the number of steps for blending the two colors of the gradient. By default this is set to Automatic.
Center X	For Radial, Ellipsoid, Square and Rectangular gradients, modify these values to set the horizontal offset of the gradient center.
Center Y	For Radial, Ellipsoid, Square and Rectangular gradients, modify these values to set the vertical offset of the gradient center.
Angle	For all gradient types, modifies the angle of the gradient axis.
Border	Increase this value to make the gradient start further away from the border of the shape.
From Color	The start color for the gradient. In the edit box enter the intensity of the color: 0% corresponds to black, 100% to the full color.
To Color	The end color for the gradient. In the edit box enter the intensity of the color: 0% corresponds to black, 100% to the full color.

Creating custom gradients

To use a modified gradient in other drawings or documents, a custom gradient has to be saved with a unique name.

- 1) Make sure the object is selected in a drawing.
- 2) Open the Area dialog and click on **Area** to open the **Area** page, then click on **Gradient** to open the options available for a gradient fill.
- 3) Select a gradient and modify it using the options given in “Table 3: Gradient options” above. As changes are made, the gradient displayed in **Preview** also changes indicating how the modified gradient will look.
- 4) Click on **Add** to open a Name dialog.
- 5) Enter a unique name for the new gradient, then click **OK** to close the Name dialog. The custom gradient is placed at the end of the gradients displayed in **Gradient** and becomes available for use in other drawings and documents.
- 6) Click **OK** to close the Area dialog and save the changes.

Modifying custom gradients

- 1) Make sure the object is selected in a drawing.
- 2) Open the Area dialog and click on **Area** to open the **Area** page, then click on **Gradient** to open the options available for a gradient fill.
- 3) Select a custom gradient in **Gradient**. Custom gradients appear below the predefined gradients in **Gradient**.
- 4) Enter the new values for the gradient options that need to be changed. See “Table 3: Gradient options” above for more information on gradient options. Depending on the type of gradient selected, some options may not be available.
- 5) If necessary and to revert back to the original gradient, click on **Reset** and any changes made are removed.
- 6) Click on **Modify** to permanently change the selected custom gradient. There is no confirmation given when modifying a custom gradient.
- 7) Click **OK** to close the Area dialog and save the changes.

Note

Using the **Modify** option on the **Gradient** page in the Area dialog permanently changes a gradient and cannot be undone. It is recommended to only modify custom gradients and not the installed LibreOffice gradients.

Renaming gradients

- 1) Select the object that uses the gradient that is going to be renamed.
- 2) Open the Area dialog and click on **Area** to open the **Area** page, then click on **Gradient** to open the options available for a gradient fill.
- 3) Right-click on the gradient and select **Rename** from the context menu.
- 4) Enter a name for the gradient in the Name dialog that opens.
- 5) Click **OK** save the change and close the Name dialog.
- 6) Click **OK** to save the changes and close the Area dialog.

Deleting custom gradients

- 1) Select an object that uses a gradient fill.
- 2) Open the Area page on the Area dialog, then click on **Gradient**.
- 3) In the *Gradient* box, select the custom gradient for deletion.
- 4) Right click on the gradient and select **Delete** from the context menu. Click on **Yes** to confirm the deletion.
- 5) Click **OK** to save the changes and close the Area dialog.

✓ Note

It is recommended to only rename or delete custom gradients that have been created. Deleting or renaming one of the predefined gradients that are installed with LibreOffice may cause problems in drawings and documents that use one of the gradients.

Advanced gradient controls

LibreOffice provides advanced gradient controls on the Transformations toolbar (Figure 99).

- 1) Make sure the object is selected in a drawing.
- 2) Open the **Area** page on the Area dialog, then click on **Gradient**.
- 3) Go to **View > Toolbars > Transformations** on the Menu bar, or click on the **Transformations** tool on the Line and Filling toolbar to open the Transformations toolbar.
- 4) Click on **Interactive gradient tool** in the Transformations toolbar. This displays a dashed line connecting two colored squares (Figure 100). The colors show the *From Color* and *To Color* used for the selected gradient.
- 5) Select the type of gradient required for the object from the options in the *Type* drop-down list. Properties available for adjustment depend on the gradient type selected, as explained below. Moving the squares has different effects depending on gradient type.
 - **Linear** — move *From Color* square to change where the gradient starts (border value). Move the *To Color* square to change the orientation (angle value).

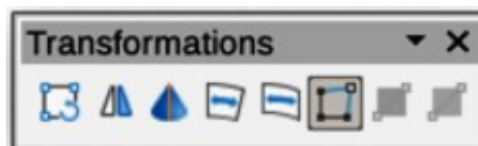

Figure 99: Transformations toolbar

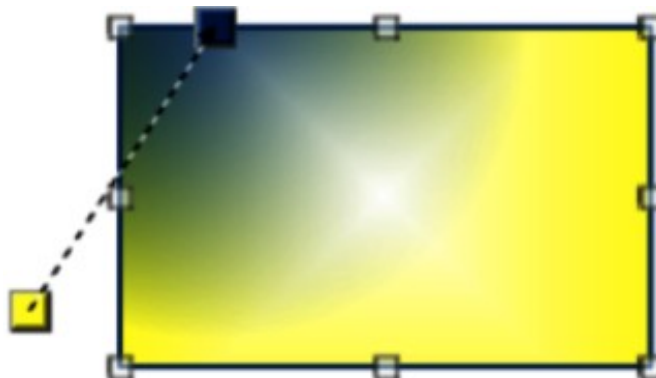

Figure 100: Example of using interactive gradient

- **Axial** — move the *To Color* square to change both the angle and border properties of the gradient. Only the *To Color* square can be moved.
 - **Radial** — move the *From Color* square to modify the border property to set the width of the gradient circle. Move the *To Color* square to change the point where the gradient ends (*Center X* and *Center Y* values).
 - **Ellipsoid** — move the *From Color* square to modify the border property to set the size of the gradient ellipsoid. Move the *To Color* square to change the angle of the ellipsoid axis and the axis itself.
 - **Quadratic** — move the *From Color* square to modify the border property to set the size of the gradient square or rectangle and the angle of the gradient shape. Move the *To Color* square to change the center of the gradient.
 - **Square** — move the *From Color* square to modify the border property to set the size of the gradient square or rectangle and the angle of the gradient shape. Move the *To Color* square to change the center of the gradient.
- 6) Click **OK** to save the changes and close the Area dialog.

✓ Note

Moving the squares creates different effects depending on the type of gradient. For example, for a linear gradient, the start and end squares of the gradient are always situated either side of the center point of the object.

Image fills

Several predefined images are included when LibreOffice is installed on a computer. The content of the supplied images cannot be edited, but the display settings can be changed. Also, images can be imported from other sources.

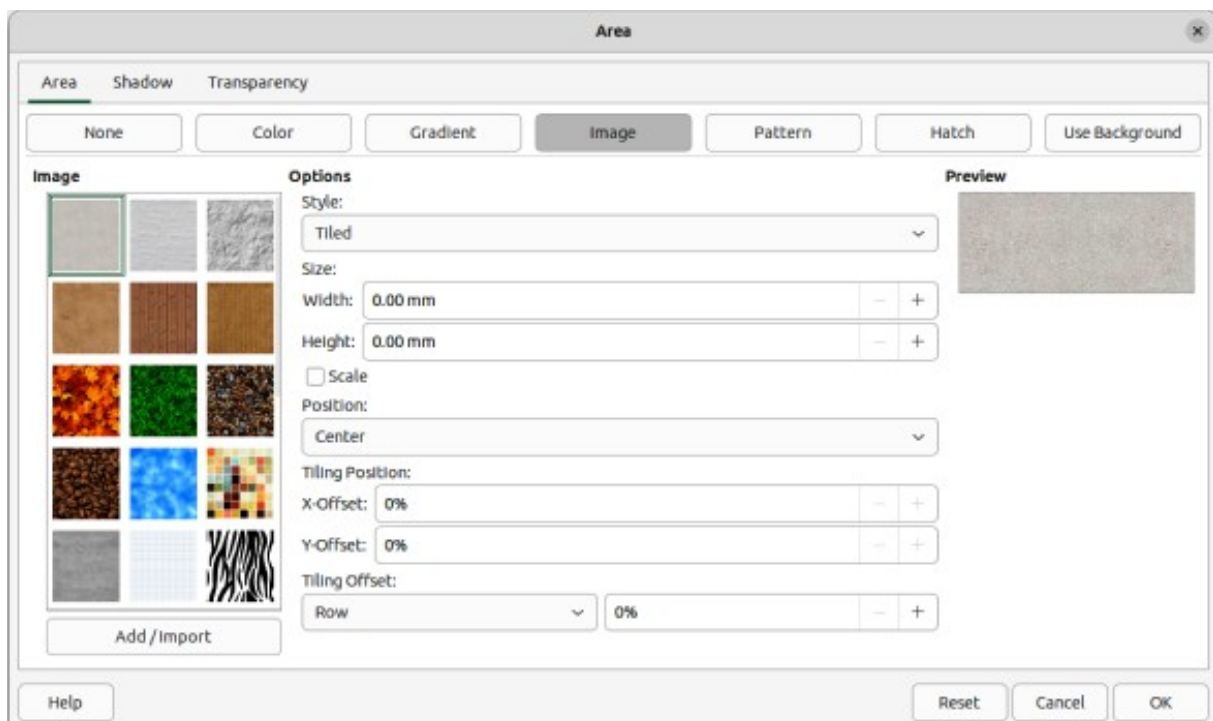

Figure 101: Area dialog — Image page

Selecting images

The following procedure to select an image for an area fill uses the **Image** page of the Area dialog (Figure 101). Using the tools on the Line and Filling Toolbar, and the **Area** panel in the Properties deck on the Sidebar is a similar procedure, but the available options are reduced.

- 1) Make sure the object is selected in a drawing.
- 2) Open the Area dialog and click on **Area** to open the **Area** page, then click on **Image** to open the options available for an image fill.
- 3) In **Image**, select the required image from the list of available images and it appears in **Preview**. Alternatively, click on **Add/Import** to open a file browser window, then select a file to use as an image fill.
- 4) If necessary, change the values in *Style*, *Size*, *Position*, *Tiling Position*, and *Tiling Offset* to modify the image to the requirements. For more information on image options, see “Table 4: Image options” below.
- 5) If necessary and to revert back to the original image, click on **Reset** and any changes made are removed.
- 6) Click **OK** to close the Area dialog and save the changes. The image fill then appears in the selected object.

Table 4: Image options

Bitmap option	Meaning
Style — Custom position/size	When this option is selected, the position and size of the image in the object can be specified.
Style — Tiled	When this option is selected, the image is tiled to fill the area. The size of the image used for the tiling is determined by the <i>Size</i> settings
Style — Stretched	When this option is selected, an image is stretched to fill the object area.
Size — Width	Sets the width of the image. For example, 100% means that the image is resized to occupy the whole fill area width, 50% means that the width of the image is half that of the fill area.
Size — Height	Sets the height of the image. For example, 100% means that the image is resized to occupy the whole fill area height, 50% means that the height of the image is half that of the fill area.
Size — Scale	When selected, image size is given as a percentage for <i>Width</i> and <i>Height</i> . When deselected, the actual size of the image is given for <i>Width</i> and <i>Height</i> .
Position	Specifies the anchoring point of the image.
Tiling Position — X-Offset	Sets the offset for the width of the image in percentage values. 50% offset means that Draw places the middle part of the image width at the anchor point and start tiling from there.
Tiling Position — Y-Offset	Sets the offset for the height of the image in percentage values. 50% offset means that Draw places the middle part of the image height at the anchor point and start tiling from there.
Tiling Offset	Offsets the columns of tiled images by the percentage entered in the box so that two subsequent columns of images are not aligned.

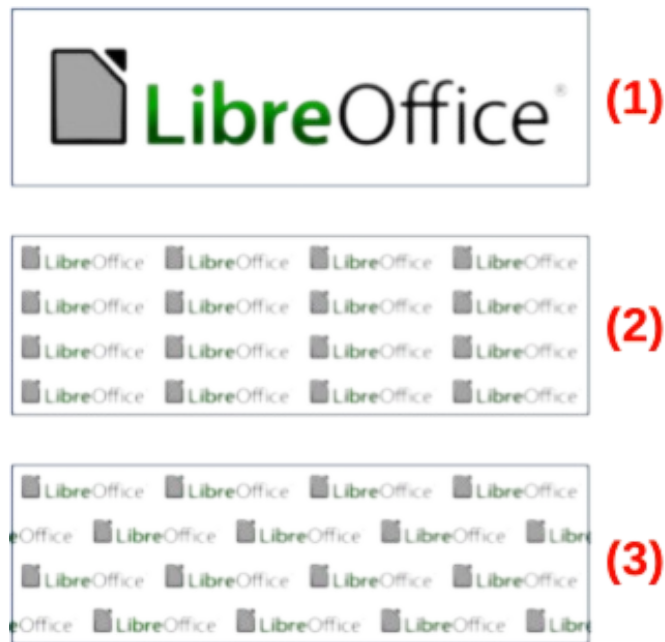

Figure 102: Examples of image fills

- 1) Original image.
- 2) Width and height 25% scaled. Anchor top left corner. No offset.
- 3) Width and height 25% scaled. Anchor top right. Row offset 50%.

Editing images

- 1) Select an object for editing that contains an image as a fill, or insert an image into a selected object
- 2) Open the Area dialog and click on **Area** to open the **Area** page, then click on **Image** to open the options available for an image fill.
- 3) Select an image from the options available in **Image** to use and edit as a fill. Note that imported images are also available. The selected image appears in **Preview**.
- 4) Change the values for *Style*, *Size*, *Position*, *Tiling Position*, and *Tiling Offset* to the requirements. For more information on image options, see “Table 4: Image options” above. Examples of image or bitmap fills and the properties used are shown in Figure 102.
- 5) If necessary and to revert back to the original image, click on **Reset** and any changes made are removed.
- 6) Click **OK** to save the changes and close the Area dialog.

✓ Note

Supplied images cannot be edited, but the display settings for placement and tiling can be changed.

Importing images

- 1) Select an object to import an image into the object.
- 2) Open the Area dialog and click on **Area** to open the **Area** page, then click on **Image** to open the options available for an image fill.
- 3) Click on **Add/Import** and a file browser window opens.

- 4) Navigate to the directory containing the image file, then select the file and click **Open**.
- 5) Enter a unique name for the new image in the Name dialog that opens, then click **OK** to close the Name dialog. The imported image appears at the bottom of the images displayed in **Image**.
- 6) Select the imported image in **Image**.
- 7) Click **OK** to save the changes and close the Area dialog. The imported image fill appears in the selected object.

Renaming images

- 1) Select an object that uses an image.
- 2) Open the Area dialog and click on **Area** to open the **Area** page, then click on **Image** to open the options available for an image fill.
- 3) Right-click on the selected image and select **Rename** from the context menu.
- 4) Enter a new name for the image in the Name dialog that opens.
- 5) Click **OK** to save the change and close the Name dialog.
- 6) Click **OK** to save the changes and close the Area dialog.

Deleting images

- 1) Make sure the object containing an image fill is selected in a drawing.
- 2) Open the **Area** page on the Area dialog, then click on **Image**.
- 3) Right click on the selected image being deleted, then select **Delete** from the context menu. Click on **Yes** to confirm the deletion.
- 4) Click **OK** to save the changes and close the Area dialog.

Note

It is recommended to only rename or delete images that have been created or imported. Renaming or deleting images that are installed with LibreOffice may cause problems in documents that uses one of these images.

Pattern fills

Several LibreOffice pattern fills are installed during a LibreOffice installation. Custom patterns can also be created and modified in LibreOffice.

Selecting pattern fills

The following procedure selects a pattern for an area fill using the Area dialog. The tools on the Line and Filling Toolbar, and the **Area** panel in the Properties deck on the Sidebar have a similar procedure, but the available options are reduced.

- 1) Make sure the object is selected in a drawing.
- 2) Open the Area dialog and click on **Area** to open the **Area** page, then click on **Pattern** to open the options available for a pattern fill (Figure 103).
- 3) In **Pattern**, select the required pattern and the selected pattern appears in **Preview**.
- 4) If necessary, change the foreground and background colors, or the pattern itself, as described in “Creating custom patterns” below. As changes are made, the pattern displayed in **Preview** also changes indicating how the pattern will look. Any changes will affect only the object being filled.

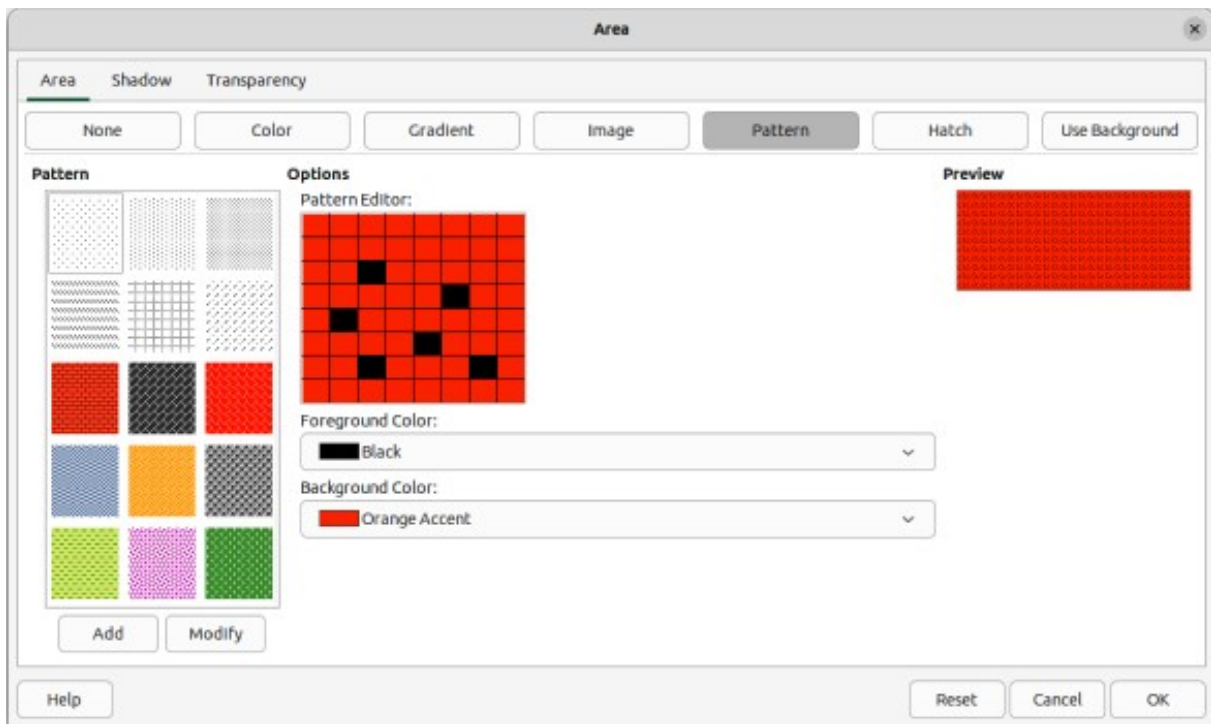

Figure 103: Area dialog — Pattern page

- 5) If necessary and to revert back to the original pattern, click on **Reset** and any changes made are removed.
- 6) Click **OK** to close the Area dialog and save the changes. The pattern fill then appears in the selected object.

Creating custom patterns

- 1) Make sure the object is selected in a drawing.
- 2) Open the Area dialog and click on **Area** to open the **Area** page.
- 3) Select the required pattern in **Pattern** to use as a starting point and the selected pattern appears in **Preview**.
- 4) In **Options**, select a color from the available color palettes for the *Foreground Color* and *Background Color*. The pattern remains the same, but the colors change.
- 5) In *Pattern Editor*, click on individual squares to change the color from *Foreground Color* to *Background Color*, or from *Background Color* to *Foreground Color* creating a new pattern.
- 6) In **Preview**, check the pattern being created to see if the desired effect is being achieved.
- 7) Click on **Add** to open a Name dialog.
- 8) Enter a unique name for the new pattern, then click **OK** to close the Name dialog. The custom pattern is placed at the end of the patterns displayed in **Pattern** and becomes available for use in other drawings and documents.
- 9) If necessary and to revert back to the original pattern, click on **Reset** and any changes made are removed.
- 10) Click **OK** to close the Area dialog and save the changes.

Note

To use a modified pattern in other drawings or documents, the custom pattern has to be saved with a unique name.

Modifying custom patterns

Using the **Modify** option on the **Pattern** page in the Area dialog permanently changes a pattern and cannot be undone. It is recommended to only modify custom patterns and not the LibreOffice patterns that were installed.

- 1) Make sure the object is selected in a drawing.
- 2) Open the Area dialog and click on **Area** to open the **Area** page, then click on **Pattern**.
- 3) Select a custom pattern from the patterns displayed in **Pattern** and the selected pattern appears in **Preview**. Custom patterns are located below the predefined patterns in the **Pattern**.
- 4) In *Pattern Editor*, click on each square to change the color from *Foreground Color* to *Background Color*, or from *Background Color* to *Foreground Color* modifying the selected pattern.
- 5) If necessary and to revert back to the original pattern, click on **Reset** and any changes made are removed.
- 6) Click on **Modify** to permanently change the selected custom pattern. There is no confirmation given when modifying a custom pattern.
- 7) Click **OK** to close the Area dialog and save the changes.

Renaming patterns

- 1) Select an object that contains a pattern, or insert a pattern into the selected object.
- 2) Open the Area dialog and click on **Area** to open the **Area** page, then click on **Pattern** to open the options available for a pattern fill. The selected pattern appears in *Pattern Editor*.
- 3) Right-click on the pattern for renaming in **Preview** and select **Rename** from the context menu.
- 4) Enter a name for the pattern in the Name dialog that opens.
- 5) Click **OK** to save the renaming and close the Name box.
- 6) Click **OK** to save the changes and close the Area dialog.

Deleting custom patterns

- 1) Select an object that contains a pattern, or insert a pattern into the selected object.
- 2) Open the Area dialog and click on **Area** to open the **Area** page, then click on **Pattern** to open the options available for a pattern fill. The selected pattern appears in *Pattern Editor*.
- 3) Right-click on the pattern for deletion in the **Preview** box and select **Delete** from the context menu.
- 4) Click on **Yes** to confirm the deletion.
- 5) Click **OK** to save the changes and close the Area dialog.

Note

It is recommended to only modify, delete or rename custom patterns that have been created. Modifying, deleting or renaming one of the LibreOffice patterns that are installed may cause problems in drawings and documents using one of the patterns.

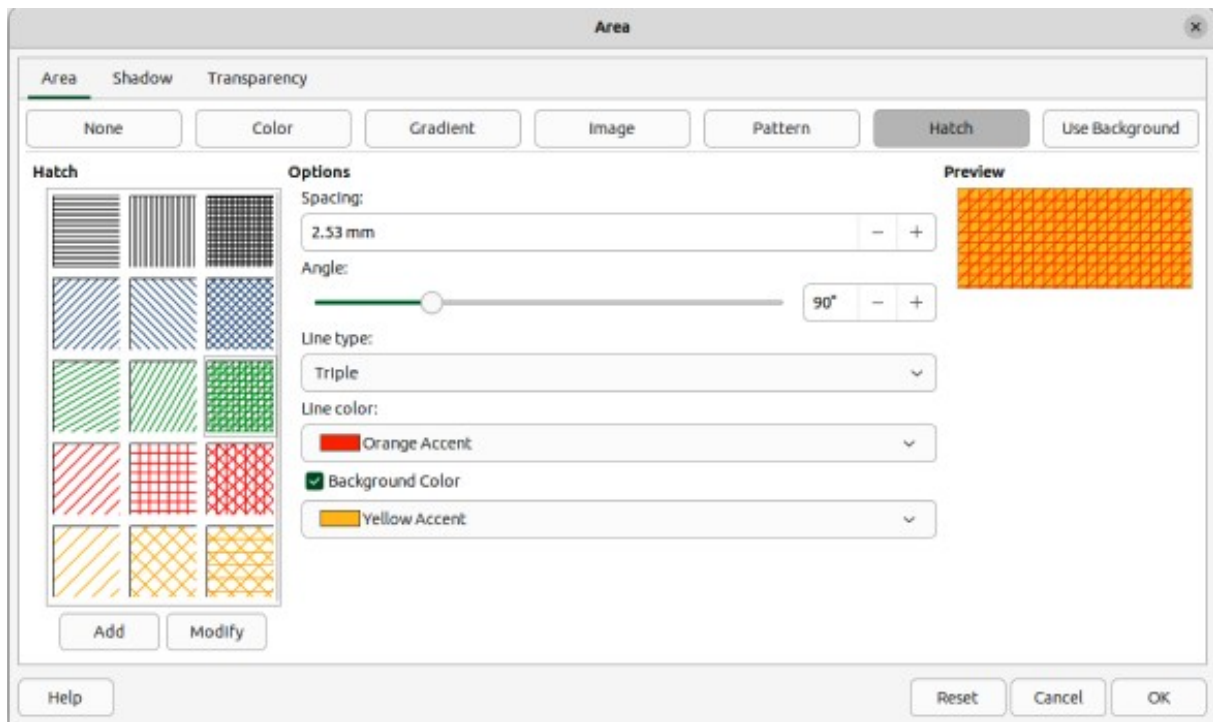

Figure 104: Area dialog — Hatch page

Hatch fills

Hatch fills are similar to pattern fills, but use lines instead of squares. Several predefined hatch fills are included when LibreOffice is installed on a computer. Custom hatch fills can also be created and modified.

Selecting hatch fills

The following procedure to select a hatch for an area fill uses the Area dialog. Using the tools on the Line and Filling Toolbar, and the **Area** panel in the Properties deck on the Sidebar is similar, but the available options are reduced.

- 1) Make sure the object is selected in a drawing.
- 2) Open the Area dialog and click on **Area** to open the **Area** page, then click on **Hatch** to open the options available for a hatch fill (Figure 104).
- 3) Select a hatch from the options shown in **Hatch** and the selected hatch fill appears in the **Preview**.
- 4) If necessary, change the colors or other options, as described in “Creating custom hatch fills” below. As changes are made, the hatch fill displayed in **Preview** also changes.
- 5) If necessary and to revert back to the original hatch fill, click on **Reset** and any changes made are removed.
- 6) Click **OK** to close the Area dialog and save the changes. The hatch fill then appears in the selected object.

Creating custom hatch fills

- 1) Make sure the object is selected in a drawing.
- 2) Open the Area dialog and click on **Area** to open the **Area** page, then click on **Hatch** to open the options available for a hatch fill.

- 3) Select the required hatch fill in **Hatch** as a starting point and the selected hatch fill appears in **Preview**.
- 4) Change the values for *Spacing*, *Angle*, *Line type*, *Line color*, and *Background color* to edit the hatch fill to the requirements. For more information on hatch fill options, see “Table 5: Hatch fill options” below.
- 5) Click on **Add** to open a Name dialog.
- 6) Enter a unique name for the new hatch fill, then click **OK** to close the Name dialog. The custom hatch fill is placed at the end of the hatch fills displayed in **Hatch** and becomes available for use in other drawings and documents.
- 7) Click **OK** to close the Area dialog and save the changes. The new hatch fill appears in the selected object.

Table 5: Hatch fill options

Hatching option	Meaning
Spacing	Determines the spacing between two lines of the hatch fill. As the value is changed, the preview window is updated.
Angle	Use the mini map below the numerical value to quickly set the angle formed by the line to multiples of 45 degrees. If the required angle is not a multiple of 45 degrees, enter the desired value in the edit box.
Line type	Set single, double, or triple line for the style of the hatch fill.
Line color	Use the list to select the color of the lines that will form the hatch fill.
Background color	When selected, adds a color fill behind the lines used for the hatch fill.

Modifying custom hatch fills

Using the **Modify** option on the **Hatch** page in the Area dialog permanently changes a hatch fill and cannot be undone.

- 1) Make sure the object is selected in a drawing.
- 2) Open the Area dialog and click on **Area** to open the **Area** page, then click on **Hatch** to open the options available for a hatch fill.
- 3) Select a custom hatch fill in **Hatch** and the selected hatch fill appears in **Preview**. Custom hatch fills are located below the predefined hatch fills in **Hatch**.
- 4) Change the values for *Spacing*, *Angle*, *Line type*, *Line color*, and *Background color* to edit the hatch fill. For more information on hatch options, see “Table 5: Hatch fill options” above.
- 5) If necessary and to revert back to the original hatch fill, click on **Reset** and any changes made are removed.
- 6) Click on **Modify** to permanently change the selected custom hatch fill. There is no confirmation given when modifying a custom hatch fill.
- 7) Click **OK** to close the Area dialog and save the changes.

Renaming hatch fills

- 1) Select the object that contains the hatch fill that is to be renamed.
- 2) Open the Area dialog and click on **Area** to open the **Area** page, then click on **Hatch** to open the options available for a hatch fill.

- 3) Right-click on the hatch fill displayed in **Hatch** and select **Rename** from the context menu.
- 4) Enter a name for the hatch fill in the Name dialog that opens.
- 5) Click **OK** to save the renaming and close the Name dialog.
- 6) Click **OK** to save the changes and close the Area dialog.

Deleting custom hatch fills

- 1) Select an object that uses the hatch fill for deletion.
- 2) Open the **Area** page on the Area dialog, then click on **Hatch**.
- 3) In the *Hatch* box, select the custom hatch fill for deletion.
- 4) Right-click on the hatch fill and select **Delete** from the context menu. Click on **Yes** to confirm the deletion.
- 5) Click **OK** to save the changes and close the Area dialog.

✓ Note

It is recommended to only modify, rename or delete hatch fills that have been created. Modifying, renaming or deleting hatch fills that were installed with LibreOffice may cause problems in documents that use one of these hatch fills.

Background image fills

Background image fills are used to allow an object create windows in a drawing and display a background image that has been placed on the drawing. Figure 105 shows an example of an ellipse, the topmost object, being used as a window through the underlying pentagon and rectangle objects to show a portion of the background image.

- 1) Select a page in a drawing that uses a background image.
- 2) Insert several objects onto the drawing page and position the objects into a stack.
- 3) Add an object that is going to be used as window onto the object stack as the topmost object and make sure it is selected.
- 4) Change the fill of the selected object to a background image fill using one of the following methods:

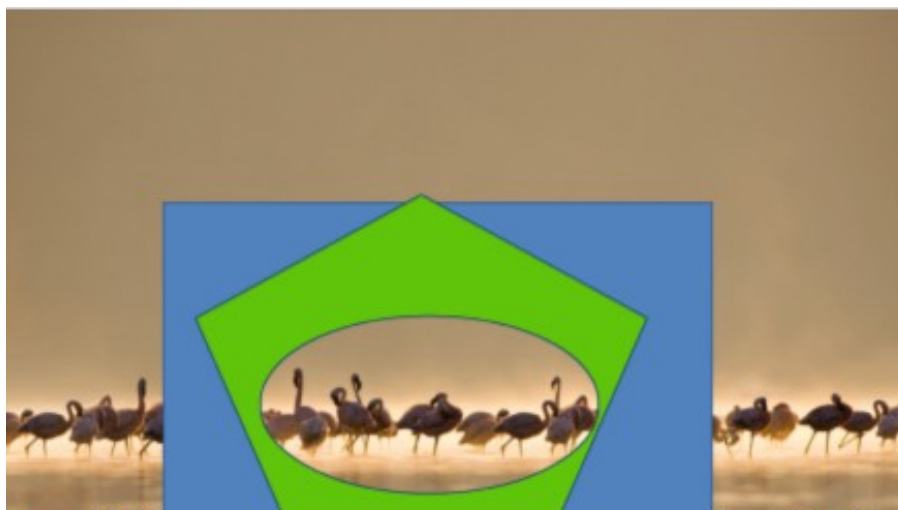

Figure 105: Example of using Background Fill

- On the Line and Filling toolbar, select **Use Slide Background** from the options available in the **Area/Style Filling** drop-down list.
 - In the **Area** panel in the Properties deck on the Sidebar, select **Use Slide Background** from the options available in the *Fill* drop-down list.
- 5) Deselect the object and the background image appears in the object creating a window.

✓ Notes

There are no options available for using a background image fill. When a background image fill is applied to an object, the whole of the object area is used for the area fill.

The option **Use Slide Background** is not available as an option for area fills in the Area dialog.

Working with shadows

Shadow options

Shadows can be applied to objects such as lines, shapes and text. The options available for shadows are as follows:

- **Position** – select one of nine points determining the direction in which the shadow is cast.
- **Distance** or **Angle** – determines the offset distance between the object and the shadow.
- **Color** – sets the color used for the shadow.
- **Blur** – sets how much the edges of a shadow are blurred or softened.
- **Transparency** – determines the amount of transparency for the shadow: 0% opaque shadow, 100% transparent shadow.

Default shadows

To quickly apply a shadow to an object, select the object and click on **Shadow** in the Line and Filling toolbar. The shadow applied to an object uses the default shadow settings in LibreOffice.

✓ Note

For more control when applying shadows, use the **Shadow** page in Area or Line dialogs. The following information uses using the **Shadow** page in the Area dialog (Figure 106), but can also be applied to the **Shadow** page in the Line dialog.

Formatting shadows

For a more control when adding shadows to an object, use the **Shadow** page on the Area or Line dialog as follows:

- 1) Select an object where a shadow is going to be applied.
- 2) Open the Area dialog and click on **Shadow** to open the **Shadow** page (Figure 106).
- 3) Select *Use shadow* in **Properties** and the shadow options become active.
- 4) Select from one of nine points the direction in which the shadow is going to be cast in relation to the object.

- 5) In *Color*, select the color palette from the drop-down list of available palettes and then select the color required for the shadow.
- 6) In *Distance*, enter a distance to set spacing between the object and the shadow.
- 7) In *Blur*, enter a value to soften the edges of the shadow.
- 8) In *Transparency*, enter a percentage for the shadow transparency.
- 9) Click **OK** to close the Area or Line dialog and save the changes.

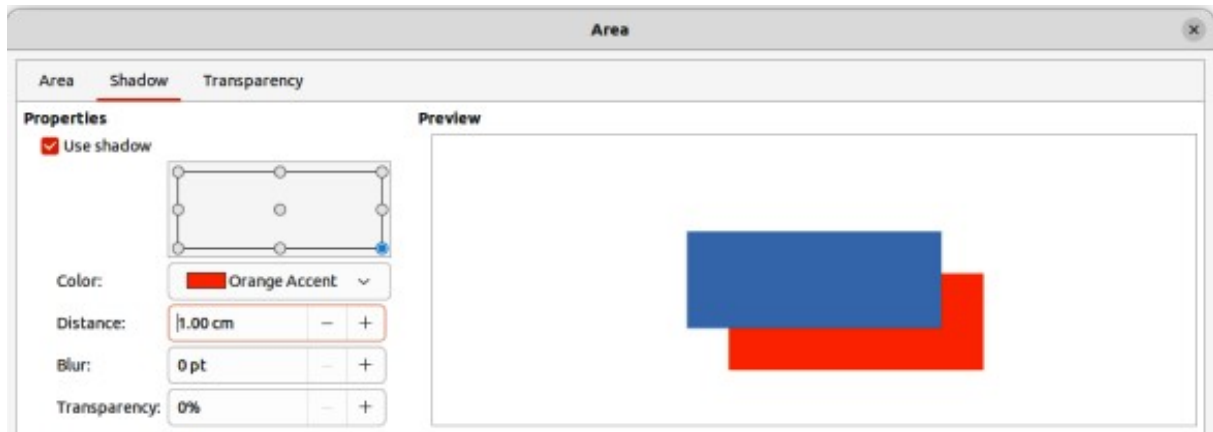

Figure 106: Area dialog — Shadow page

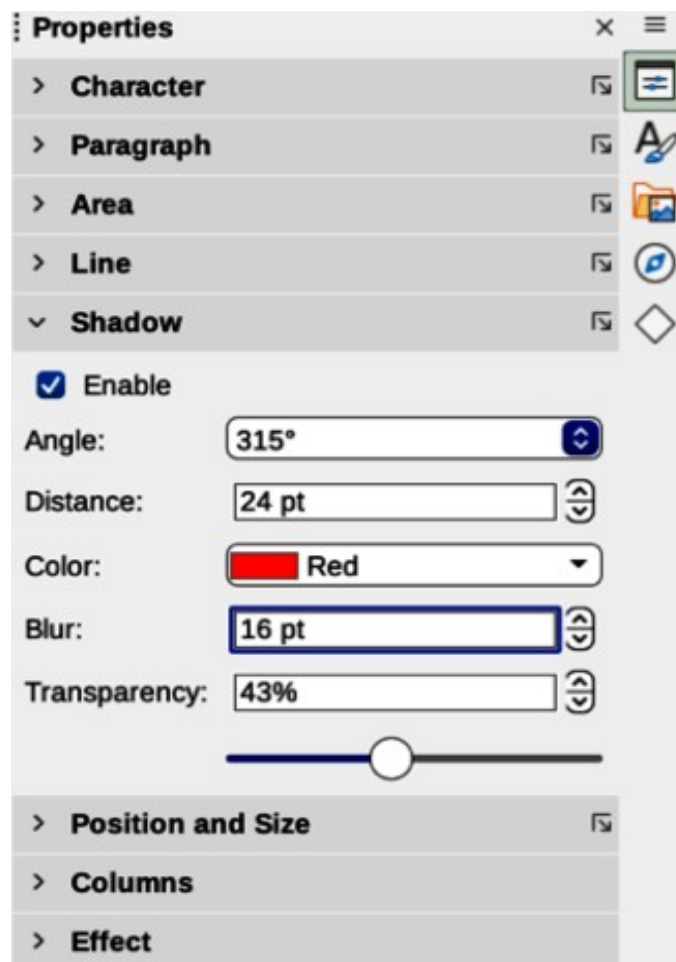

Figure 107: Shadow panel in Properties deck on Sidebar

Sidebar shadow formatting

- 1) Select an object where a shadow is going to be applied.
- 2) Click on **Properties** to open the Properties deck on the Sidebar.
- 3) Click on **Shadow** to open the **Shadow** panel (Figure 107) in the Properties deck.
- 4) Select *Enable* and the shadow options become active.
- 5) In *Angle*, select from one of the options in the drop-down list to set the direction of where the shadow is going to be cast in relation to the object.
- 6) In *Color*, select the color palette from the drop-down list of available palettes and then select the color required for the shadow.
- 7) In *Distance*, enter a distance to set spacing between the object and the shadow.
- 8) In *Blur*, enter a value to soften the edges of the shadow.
- 9) In *Transparency*, move the slider or enter a percentage in the text box to set the shadow transparency.
- 10) Deselect the object to save the changes made.

Working with transparencies

Transparencies can be applied to objects and shadows that have been applied to an object. In Draw, two types of transparencies can be applied to an object – uniform transparency and gradient transparency.. For more information on gradient transparencies, including an example of combining a color gradient with a gradient transparency, see “Gradient fills” on page 94.

Transparencies can be applied to area fills as well as shadows and lines.

- To use transparencies on lines, refer to “Who is this user guide for?” on page 8 for more information.
- To use transparencies on shadows, refer to “Working with shadows” on page 107 for more information.

The following procedure applies a transparency to an object area fill using the Area dialog (Figure 108):

- 1) Make sure the object is selected in a drawing.
- 2) Open the Area dialog, then click on **Transparency** to open the **Transparency** page and access the available options.
- 3) To create a uniform transparency, select *Transparency* and enter a percentage in the text box.
- 4) To create a gradient transparency so that the area becomes gradually transparent, select *Gradient* and select the type of gradient transparency from the drop-down list: *Linear*, *Axial*, *Radial*, *Ellipsoid*, *Quadratic* or *Square*. See “Table 3” on page 95 for more information on gradient types.
- 5) Set the parameters for the type of the gradient transparency selected above. Refer to “Table 6: Transparency parameters” below for a description of the properties. The parameters available depends on the type of gradient transparency selected above.
- 6) Click **OK** to close the Area dialog and save the changes.



Figure 108: Area dialog — Transparency page

Table 6: Transparency parameters

Transparency parameters	Meaning
Centre X	For <i>Radial</i> , <i>Ellipsoid</i> , <i>Quadratic</i> and <i>Square</i> gradients. The values to set the horizontal offset of the gradient center.
Center Y	For <i>Radial</i> , <i>Ellipsoid</i> , <i>Quadratic</i> and <i>Square</i> gradients. The values to set the vertical offset of the gradient center.
Angle	For <i>Linear</i> , <i>Axial</i> , <i>Ellipsoid</i> , <i>Quadratic</i> and <i>Square</i> gradients. Specifies the angle of the gradient axis.
Border	Increase this value to make the gradient start further away from the border of the object.
Start value	Value for the starting transparency gradient. 0% is fully opaque, 100% means fully transparent.
End value	Value for the ending transparency gradient. 0% is fully opaque, 100% means fully transparent.

Drawing styles

If the same area fill, line thickness, and border are to be applied to a set of objects, this repetitive process is simplified by using styles. Styles allows format to be defined and applied to multiple objects. For more information on styles, see the *Writer Guide*.

Note

The drawing styles included with LibreOffice Draw cannot be deleted or renamed, but can be modified to the drawing requirements. Drawing styles can be hidden when not required, except for drawing styles that have been used in a drawing.

Style categories

All Styles

Displays all the drawing styles available for use.

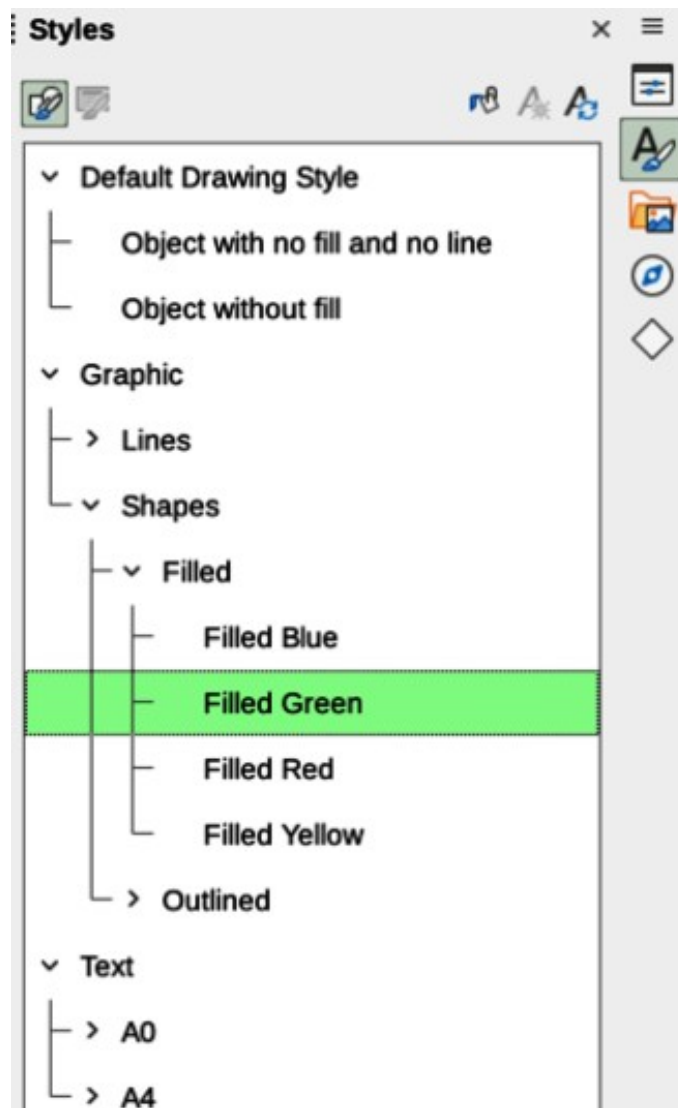

Figure 109: Styles deck on Sidebar

i Tips

Hierarchical styles are used when multiple objects differ in one or two options but are otherwise identically formatted. Create a parent style for the objects including borders, area fill, font, and so on. Then create a hierarchical or child styles, which differ, for example, in fill color. If the font size or the thickness of a border needs to be changed, it is sufficient to change the parent style and all the child styles are changed accordingly.

At the bottom of the Styles deck on the Sidebar there is a drop-down list allowing selection of the style category. The style categories available are *Hierarchical*, *All Styles*, *Hidden Styles*, *Applied Styles*, and *Custom Styles*.

Applied Styles

Displays drawing styles that have been used in the selected drawing.

Hierarchical Styles

Displays the drawing styles in a hierarchical list (also known as a linked or parent/child styles). To view the styles in a sub-level, click on the triangle ► or chevron > next to the style name listing the styles available in the sub-level, as shown in Figure 109.

Custom Styles

Displays all the user created drawing styles that are available for use.

Hidden Styles

Displays all the drawing styles that a user has hidden when not required.

Note

When an object is placed into a drawing, the **Default Drawing Style** is automatically applied.

Selecting styles

Styles can only be selected and applied to objects using the Styles deck on the Sidebar (Figure 109).

- 1) Select the object for style application.
- 2) Open the Styles deck on the Sidebar using one of the following methods:
 - Go to **View > Sidebar** on the Menu bar, then click on **Styles** at the right side of the Sidebar.
 - Click on **Show the Styles Sidebar** on the Line and Filling toolbar.
 - Go to **View > Styles** on the Menu bar.
 - Use the keyboard shortcut *F11*.
- 3) Select a style category from the drop-down list at the bottom of the Styles deck.
- 4) In the Styles deck, double-click on the style required for the selected object.
- 5) If necessary, create a custom style or modify the selected style to the requirements.

Note

It is recommended to create custom styles rather than modify the drawing styles installed with LibreOffice. Modifying drawing styles installed with LibreOffice may cause problems if the style has been used in other drawings.

Creating custom styles

After creating a custom style, it is placed in **All Styles** and **Custom Styles** categories in the Styles deck of the Sidebar. When the custom style is applied to an object, the custom style also appears in **Applied Styles**.

Using Styles deck

- 1) Open the Styles deck on the Sidebar.
- 2) Right click on the style required as a starting point to create a custom style and select **New** from the context menu to open the Graphic Styles dialog (Figure 110).
- 3) Click on the **Organizer** tab to open the **Organizer** page in the Graphic Styles dialog.
- 4) In the *Name* text box, enter a unique style name.
- 5) In *Inherit from* text box, select **None** from the drop-down list if the new drawing style is NOT going to be linked. When the object was created, it was allocated the Default Drawing Style and this new drawing style is linked by default to the Default Drawing Style.

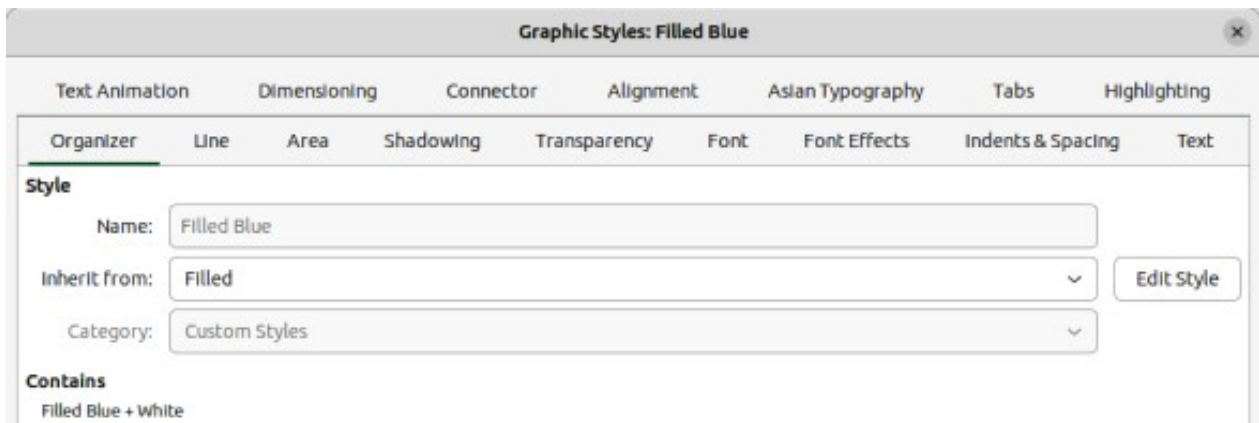

Figure 110: Graphic Styles dialog — Organizer page

- 6) If the new style is to inherit settings from an existing style, select a style from the *Inherit from:* drop-down list.
- 7) Use the options on the various pages of the Graphic Styles dialog to format and categorize a new style.
 - **Organizer** – contains a summary of the style and its hierarchical position.
 - **Font, Font Effects, Indents & Spacing, Alignment, and Tabs** – sets the attributes of the text inserted into a text box or graphic object.
 - **Dimensioning** – sets the style of dimension lines when used on an object.
 - **Text, Text Animation, Connector, Line, Area, Shadowing, Highlighting and Transparency** – sets the attributes for the object format..
- 8) Click **OK** to save the new style and close the Graphic Styles dialog.

✓ Note

Any new drawing style created is automatically placed in the **Custom Styles** category.

Using New Style from Selection

Using **New Style from Selection** allows all formatting to be made to an object first and then create a drawing style from the formatting changes.

- 1) Select an object to create a new style from, or create a new object in a drawing.
- 2) Format the object using the tools and options from the Graphic Styles dialog, Area dialog, Line dialog, Properties deck on the Sidebar, or Line and Filling toolbar.
- 3) Make sure the object is selected and create the new style using one of the following methods:
 - Open the Styles deck on the Sidebar and click on **New Style from Selection** at the top right of the deck.
 - Go to **Format > Styles > New Style from Selection** on the Menu bar.
- 4) In the New Style from Selection dialog, type a unique name for the new style. This dialog also shows existing custom styles.
- 5) Click **OK** to save the new style and close the New Style from Selection dialog.

Modifying styles

- 1) Select an object in a drawing.
- 2) Click on **Styles** on the left of the Sidebar to open the **Styles** deck.
- 3) Open the Graphic Styles dialog using one of the following methods:
 - Go to **Format > Styles > Edit Style** on the Menu bar.
 - Right-click on the object and select **Edit Style** from the context menu.
 - Right-click on the style that is highlighted in the Styles deck on the Sidebar and select **Modify** from the context menu.
- 4) Use the options on the various pages of the Graphic Styles dialog to modify the style.
- 5) Click **OK** to save the changes and close the Graphic Styles dialog.

Note

It is recommended to only modify custom styles. Modifying styles installed with LibreOffice may cause problems in other documents using one of these styles.

Editing hierarchical or parent styles

If an object uses a style that is linked to a hierarchical or parent style, then it is possible to edit the hierarchical or parent style.

- 1) Select an object in a drawing that uses a linked style.
- 2) Open the Graphic Styles dialog and click on **Organizer** to open the **Organizer** page in the Graphic Styles dialog.
- 3) Check that the style name in the *Inherit from* text box is the hierarchical or parent style for editing, then use the options on the various pages in the Graphic Styles dialog to edit the style.
- 4) If the hierarchical or parent style is NOT the one required:
 - a) Click on **Edit Style** to the right of the *Inherit from* text box until the name of the style is displayed.
 - b) Use the options on the various pages in the Graphic Styles dialog to edit the style.
- 5) Click **OK** to save the changes and close the Graphic Styles dialog.

Note

It is recommended to create custom hierarchical styles rather than modify the LibreOffice hierarchical styles. Modifying hierarchical styles installed with LibreOffice may cause problems if the style has been used in other drawings.

Updating styles

Using **Update Style** allows all the formatting to an object to be made first and then update the drawing style used by the object.

- 1) Select the object to modify the drawing style the object uses.
- 2) Format the object using the tools and options from the Graphic Styles dialog, Area dialog, Line dialog, Properties deck on the Sidebar, or Line and Filling toolbar.

- 3) Update the drawing style using one of the following methods. There is no confirmation when updating a drawing style.
 - Open the Styles deck on the Sidebar and click on **Update Style** at the top right.
 - Go to **Format > Styles > Update Selected Style** on the Menu bar

Note

Make sure to only update custom styles that have been created. Updating styles that are part of the default installation of LibreOffice could cause problems in other documents that use LibreOffice drawing styles.

Applying styles

Drawing styles are applied to an object using the Styles deck on the Sidebar as follows:

- 1) Select the object to apply a drawing style.
- 2) Click on **Styles** on the Line and Filling toolbar, or click on **Styles** on the Sidebar.
- 3) Double click on the style name to apply the drawing style to the selected object.

Deleting styles

Predefined styles in LibreOffice cannot be deleted, even if the styles are not being used. Only custom styles can be deleted.

- 1) To open a list of styles, use one of the following methods:
 - Click on **Styles** on the Line and Filling toolbar.
 - Click on **Styles** on the Sidebar.
- 2) Select *Applied Styles* from the drop-down list at the bottom of the Styles deck on the Sidebar.
- 3) Right click on the style name in the styles list and select **Delete** from the context menu.
- 4) If the style is used on an object, a warning message appears stating that the selected object will revert back to the default drawing style. Select **Yes** to confirm deletion of the style.
- 5) If the style is not in use, select **Yes** to confirm deletion of the style and there is no confirmation message.

Note

Before deleting a custom style, it is recommended to make sure the drawing style is not in use by checking the list of drawing styles in the Applied Styles category.

Special effects

As well as the basic actions of moving and resizing an object, a number of special effects can also be applied to objects in Draw. Several of these effects are readily available in the Transformations toolbar. If the Transformations toolbar (Figure 99 on page 97) is not open, go to **View > Toolbars > Transformations** on the Menu bar and select **Transformations**.

The tools on the Transformations toolbar are described in the following sections with the exception of the **In 3-D Rotation Object** tool, which is described in Chapter 7, Working with 3D Objects.

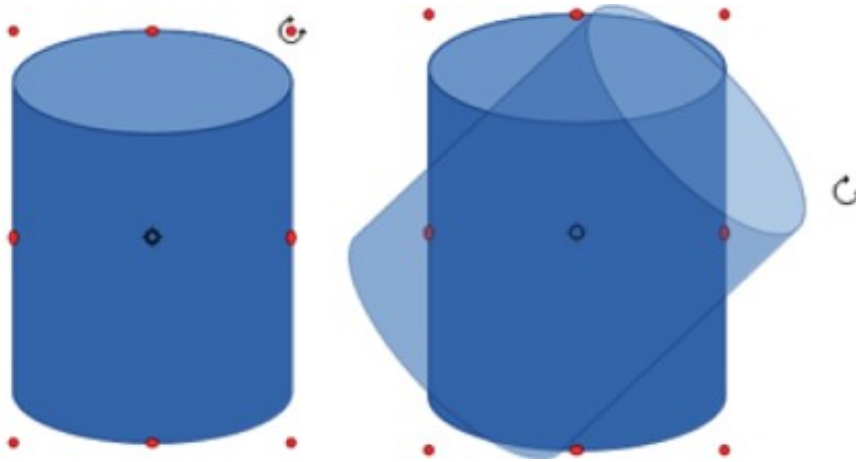

Figure 111: Example of manual rotation

Rotating objects

Manual rotation

- 1) Select an object for rotation so that the selection handles are displayed.
- 2) Use one of the following methods to switch the selected object into rotation mode. The selection handles change shape and color when in rotation mode (Figure 111).
 - Click again on the selected object.
 - Click on the triangle ▼ to the right of **Transformations** on the Line and Filling and select **Rotate** from the context menu.
 - If the Transformations toolbar is open, click on **Rotate**.
- 3) Move the cursor over one of the corner handles and the cursor changes shape. Only corner selection handles are active for rotation.
- 4) Click and hold on a corner selection handle and drag the object to rotate it.
- 5) To restrict the rotation angles to multiples of 15 degrees, press and hold the *Shift* key while rotating the object. This is useful for rotating objects through 90 deg.
- 6) When satisfied with the rotation, release the corner selection handle.
- 7) By default, the rotation pivot point is a small circle in the center of the selected object. To change the center of object rotation, click and hold the rotation pivot point, then drag it to a new position. The rotation pivot point can be positioned outside of the selected object.

Sidebar rotation

- 1) Select the object for rotation so that the selection handles are displayed.
- 2) Open the **Position and Size** panel in the Properties deck on the Sidebar (Figure 112).
- 3) Rotate the object using one of the following options:
 - Click on and drag the *Rotation Angle* indicator in *Rotation*.
 - Enter a rotation angle in the *Select the angle for rotation* text box.
- 4) After rotating the object, click outside the object to deselect the object and save the changes.

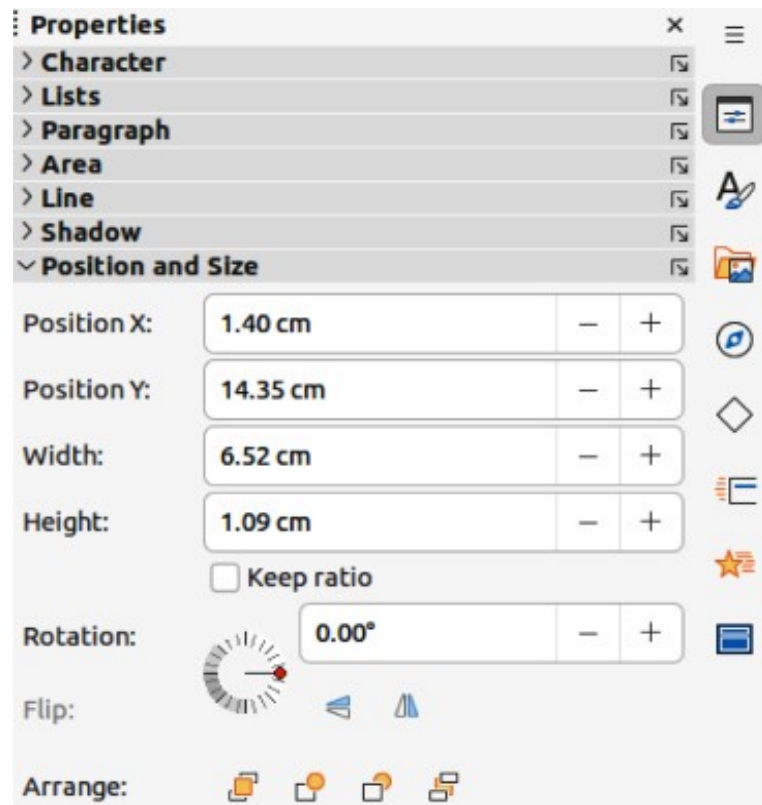

Figure 112: Position and Size panel in Properties deck on Sidebar

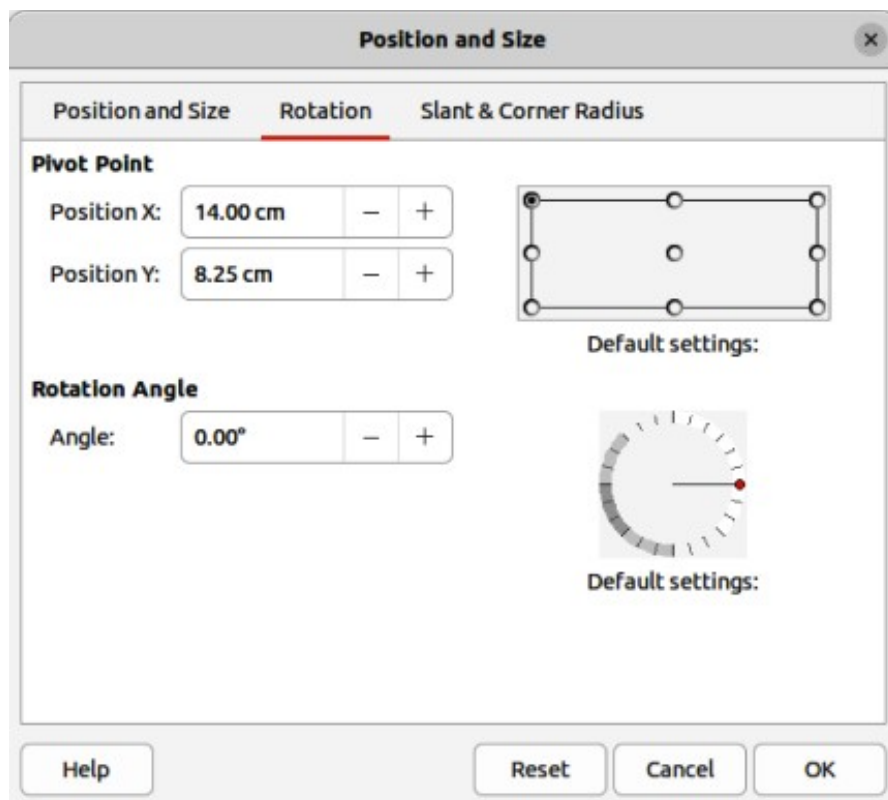

Figure 113: Position and Size dialog — Rotation page

Position and Size dialog

- 1) Select the object for rotation so that the selection handles are displayed.

- 2) Open the Position and Size dialog (Figure 113) using one of the following methods:
 - Use the keyboard shortcut *F4*.
 - Select **Format > Position and Size** on the Menu bar.
 - Right-click on the object and select **Position and Size** from the context menu.
- 3) Click **Rotation** to open the **Rotation** page.
- 4) If required, in **Pivot Point** enter a value for *Position X* and *Position Y* to move the position of the pivot point. The default position of the pivot point is the center of the object. Alternatively, select a pivot point from one of the 9 positions in *Default settings*.
- 5) In **Rotation Angle**, rotate the object using one of the following methods:
 - In the *Angle* text box, enter the degrees of rotation required.
 - Click on and drag the rotation indicator in *Default settings*.
- 6) Click **OK** to save the changes and close the Position and Size dialog.

Flipping objects

Quick flipping

- 1) Select the object for flipping to display the selection handles.
- 2) Use one of the following methods to flip the object vertically or horizontally:
 - Right click on the object and select **Flip > Horizontally** or **Flip > Vertically** from the context menu.
 - In the **Position and Size** panel in the Properties deck on the Sidebar, click on **Flip Vertically** or **Flip Horizontally**.
 - In the Line and Filling toolbar, click on **Vertically** or **Horizontally**.
 - Go to **Shape > Flip > Vertically** or **Horizontally** on the Menu bar.

Flip tool

Using **Flip** on the Transformations toolbar (Figure 99 on page 97), the position and angle that the object flips over can be changed, as shown by the example in Figure 114.

- 1) Select the object for flipping to display the selection handles.
- 2) Click on **Flip** on the Transformations toolbar and the symmetry axis appears as a dashed line through the middle of the object. The object is flipped about this symmetry axis.

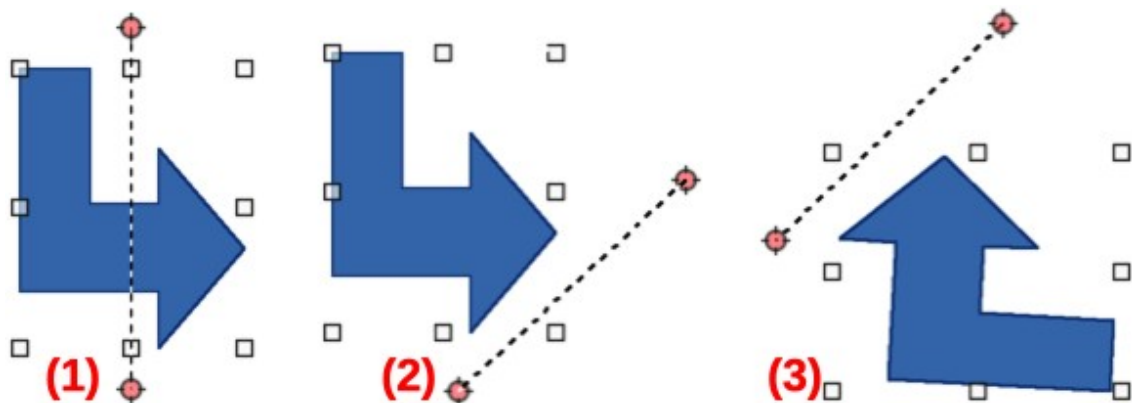

Figure 114: Example of using Flip tool

- 1) Flip selected
- 2) Symmetry axis moved
- 3) Flip result

- 1) Click and drag one or both ends of the symmetry axis setting the axis orientation.
- 2) Place the cursor over one of the object selection handles until it changes shape.
- 3) Click and hold the selection then drag the object across to the other side of the symmetry axis until the object appears flipped over. The angle and position of the flip depends on the angle and position of the symmetry axis.
- 4) Release the selection handle and the object is flipped.

✓ Note

Pressing and holding the *Shift* key while moving the symmetry axis allows rotation in 45 degree increments

Mirror copies

At the moment there is no mirror command available in Draw. However, mirroring an object can be emulated by copying and flipping the object as follows:

- 1) Select the object to copy the object to the clipboard.
- 2) Flip the object using the procedures in “Flipping objects” above.
- 3) Click in an empty area on the drawing to deselect the object.
- 4) Paste the copy of the original object back into its original location creating a mirror copy.
- 5) If necessary, select both objects and align them using one of the following methods:
 - Go to **Shape > Align** on the Menu bar and use one of the alignment options.
 - Right-click the selected objects and select **Align** from the context menu, then select one of the alignment options.

Distorting images

Three tools on the Transformations toolbar allow an object to be distorted.

- **Distort** – distorts an object in perspective.
- **Set to circle (slant)** and **Set in Circle (perspective)** – both create a pseudo 3D effect.

✓ Note

Before distorting an object, the object must be converted to a curve. Transforming an object into a curve is a safe operation, but cannot be reversed other than by clicking **Format > Undo** on the Menu bar.

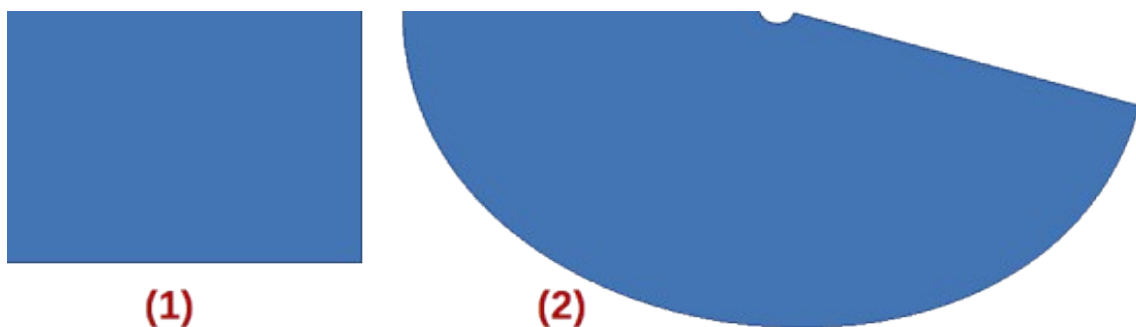

Figure 115: Example of using Set in Circle (perspective) tool

1) Original object

2) Set in Circle (perspective) distortion

Set in circle (perspective)

An example of distorting an object with the **Set in Circle (perspective)** tool is shown in Figure 115.

- 1) Select an object and click on the **Set in Circle (perspective)** in the Transformations toolbar.
- 2) Click **Yes** to convert the object to a curve. If the object is already a curve, this dialog does not appear.
- 3) Click and drag one of the selection handles to give a pseudo 3D perspective using the opposite side as an anchor point. A ghosted image appears as the object is distorted to give an indication of how the resulting object will look.

Set to circle (slant)

An example of distorting an object with the **Set to circle (slant)** tool is shown in Figure 116.

- 1) Select an object and click on the **Set to circle (slant)** in the Transformations toolbar.

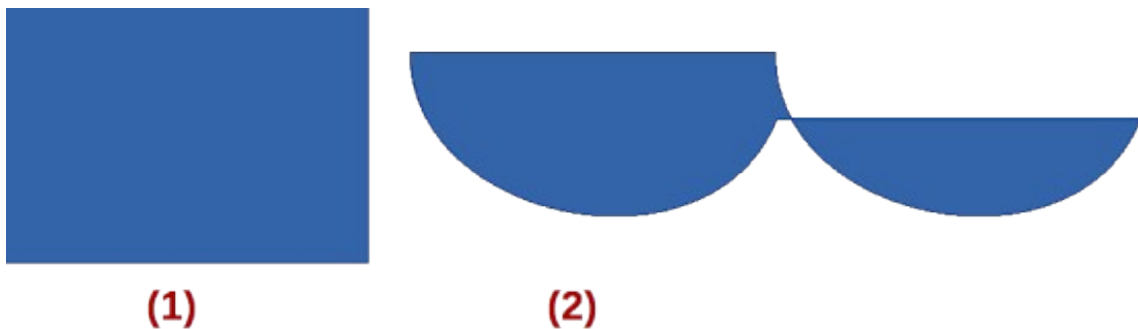

Figure 116: Example of using Set in circle (slant) tool

1) Original object

2) Set in circle (slant) distortion

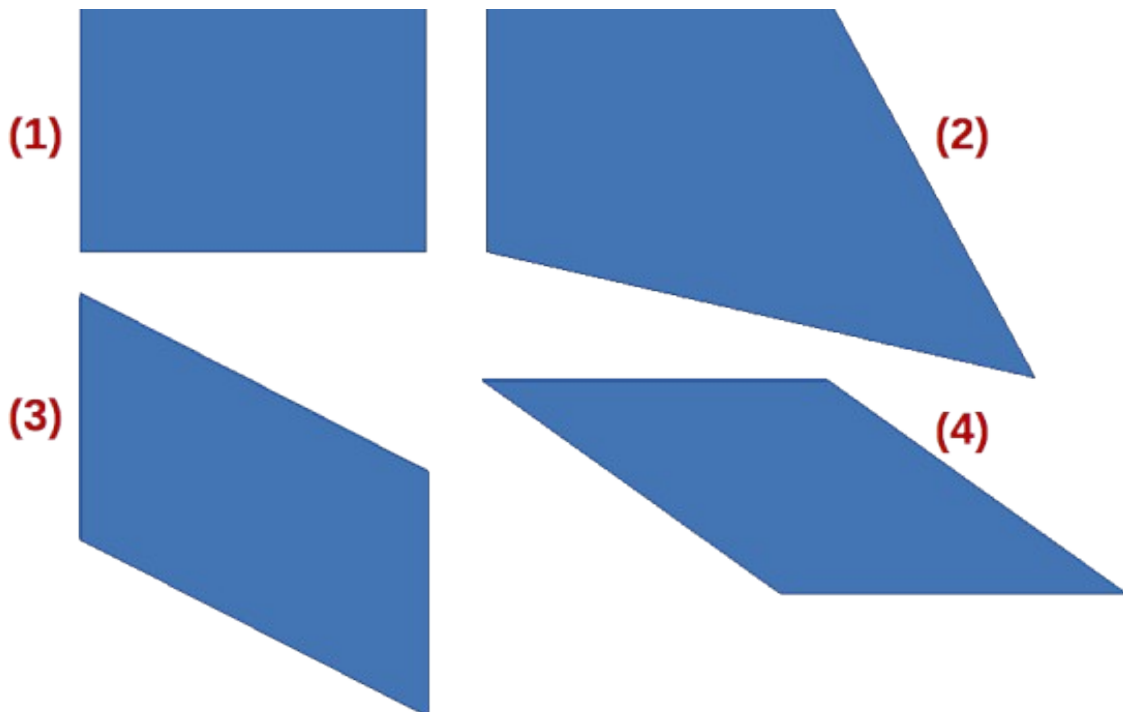

Figure 117: Example of using Distort tool

1) Original object

2) Corner distortion

3) Vertical distortion

4) Horizontal distortion

- 1) Click **Yes** to convert the object to a curve. If the object is already a curve, this dialog does not appear.
- 2) Click and drag one of the selection handles to give a pseudo 3D perspective using the opposite side as an anchor point. A ghosted image appears as the object is distorted to give an indication of how the resulting object will look.

Distort

Examples of distorting an object with the **Distort** tool are shown in Figure 117.

- 1) Select an object and click on **Distort** on the Transformations toolbar.
- 2) Click **Yes** to convert the object to a curve. If the object is already a curve, this dialog does not appear.
- 3) Click and drag a corner selection handle to distort the object using the opposite corner selection handle as an anchor point for the distortion.
- 4) Click and drag the vertical selection handles to distort the object using the opposite vertical side as an anchor point for the distortion.
- 5) Click and drag the horizontal selection handles to distort the object using the opposite horizontal side as an anchor point for the distortion.

Dynamic gradients

Transparency gradients are controlled in the same manner as color gradients and both types of gradient are used together. With a transparency gradient, the direction and degree of object fill color changes from opaque to transparent. In a color gradient, the fill changes from one color to another, but the degree of transparency remains the same.

Two icons on the Transformations toolbar dynamically control transparency and color gradients. Even if an object with a color fill is not assigned transparency, the transparency can be controlled by clicking on **Interactive transparency tool**. This defines a transparency gradient and a dashed line connecting two squares appears on the object. Move the two squares to modify the gradient. Define the direction of the gradient (vertical, horizontal, or at any angle) and the spot at which the transparency begins.

A regular color gradient is defined in the same manner. Select an object, then select a gradient area fill (see “Gradient fills” on page 94 for more information). The **Interactive gradient tool** is now active on the Transformations toolbar. When clicking on **Interactive gradient tool**, a dashed line connecting two squares appears on the object, just as it does for a transparency gradient.

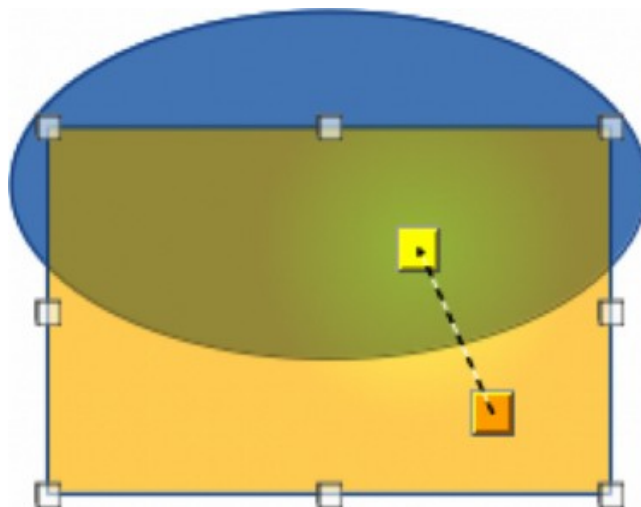

Figure 118: Example of a dynamic gradient

In both transparency gradient and gradient fill, click outside the object to set the gradient.

In the example shown in Figure 118 there is a single color object and a transparency gradient, covering part of the underlying object. This gradient transparency can be dynamically adjusted. Direction of transparency is changed by moving the white square and the distance over which it is applied by moving the green square.

 **Note**

Moving the squares has different effects, depending on the type of gradient. For example, for a linear gradient, the start and end squares of the gradient are always situated on either side of the center point of the object.



LibreOffice
Community



Draw Guide 7.5

Chapter 5, Combining Multiple Objects

Grouping objects

Grouping of objects is similar to placing objects into a container. Objects within a group are moved together as one object and any changes made are applied globally to the objects within the group. A group can always be ungrouped and the objects that make up the group can always be manipulated separately.

Temporary grouping

A temporary grouping is when several objects are selected together. Any changes to object parameters are applied to all of the objects within the temporary group. For example, a temporary group of objects can be rotated in its entirety and is created using one of the following methods:

- Click and drag the cursor over several objects surrounding the objects with a selection rectangle. This selection rectangle is also known as a marquee. Release the cursor when all the objects required for a temporary group are selected.
- Click the first object, then hold down the *Shift* key and click on the remaining objects for the temporary group.
- To cancel a temporary group of objects, simply click outside of the selection handles displayed around the objects.

Grouping

When objects are grouped, any editing carried out on the group are applied to all objects within the group. Click on one object in a group and the whole group is selected. Objects within a group retain their own individual properties and can be edited independently. See “Editing individual group objects” on page 125 for more information.

- 1) Select objects for a group using one of the following methods. Selection handles appear around all objects selected for the group (Figure 119).
 - Click on each object required while holding down the *Shift* key.
 - Make sure **Select** on the Drawing toolbar is selected and draw a selection rectangle around the objects required for the group using the cursor.
 - To select all the objects in a drawing, go to **Edit > Select All** on the Menu bar, or use the keyboard shortcut *Ctrl+A* (macOS *⌘+A*).

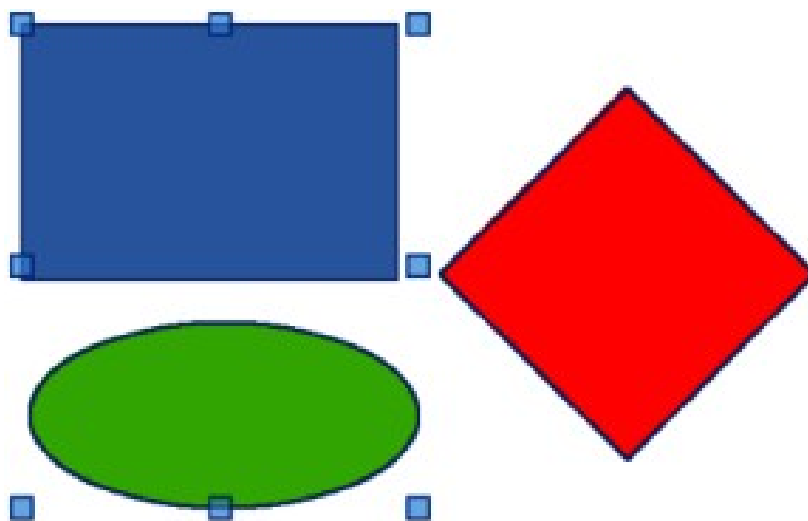

Figure 119: Example of grouping objects

- 2) Create a group of selected objects using one of the following methods:

- Right-click on an object within the selected group and select **Group** from the context menu.
- Go to **Shape > Group > Group** on the Menu bar.
- Use the keyboard shortcut *Ctrl+Shift+G* (macOS *⌘+Shift+G*).

Ungrouping

- 1) Select a group of objects and selection handles appear around objects within the group (Figure 119).
- 2) Ungroup a group of objects using one of the following methods:
 - Right-click on the selected group and select **Ungroup** from the context menu.
 - Go to **Shape > Group > Ungroup** on the Menu bar.
 - Use the keyboard shortcut *Ctrl+Alt+Shift+G* (macOS *⌘+⌘+Shift+G*).

Editing individual group objects

An object within a group can be edited individually without ungrouping the objects.

- 1) Select a group, then enter the group using one of the following methods.
 - Right-click on the group and select **Enter Group** from the context menu.
 - Go to **Shape > Group > Enter Group** on the Menu bar.
 - Use the keyboard shortcut *F3*.
 - Double-click on the selected group.
- 2) Click on an object to select and individually edit it, as shown by the example in Figure 120.
- 3) After editing and saving changes to an individual object within a group, exit the group using one of the following methods:
 - Right-click on the group and select **Exit Group** from the context menu.

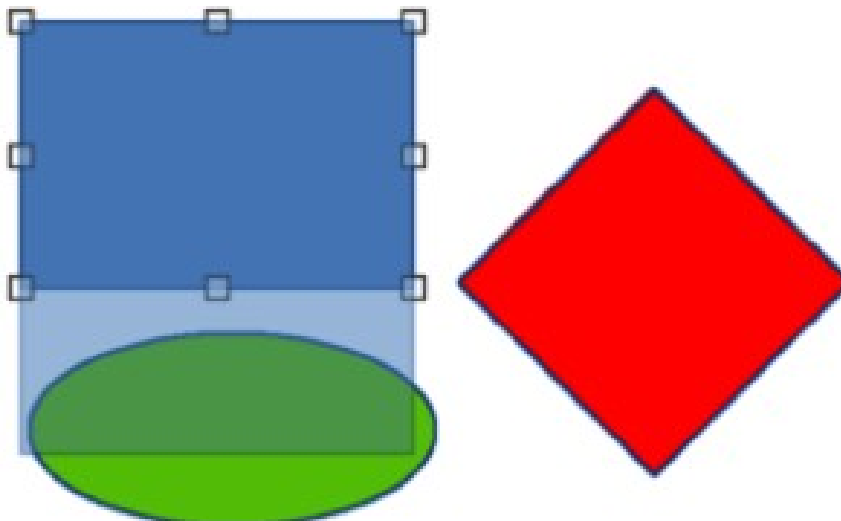

Figure 120: Example of editing individual objects within a group

- Go to **Shape > Group > Exit Group** on the Menu bar.

- Use the keyboard combination *Ctrl+F3* (macOS *⌘+F3*).
- Double-click outside the group.

✓ Note

After entering a group, any other objects outside the group cannot be selected for editing until exiting from the selected group.

Nesting groups

A group of groups can be created and this is commonly known as nesting groups. When nested groups are created, Draw retains the individual group hierarchy and remembers the order in which groups were selected. That is, the last individual group selected is on top of all the other groups within a nested group. Ungrouping and entering a nested group works in exactly the same way as for individual groups.

i Tip

If group and ungroup commands are regularly used, or any other command, tools can be added to a toolbar so that they are readily available. See Appendix B, Toolbars and the *Getting Started Guide* for more information on customizing toolbars.

Combining, splitting, breaking, and connecting

Combining objects

Combining objects is a permanent merging of objects creating a new object. The original objects are no longer available as individual objects and cannot be edited as individual objects.

- 1) Select several objects that are overlapping each other.

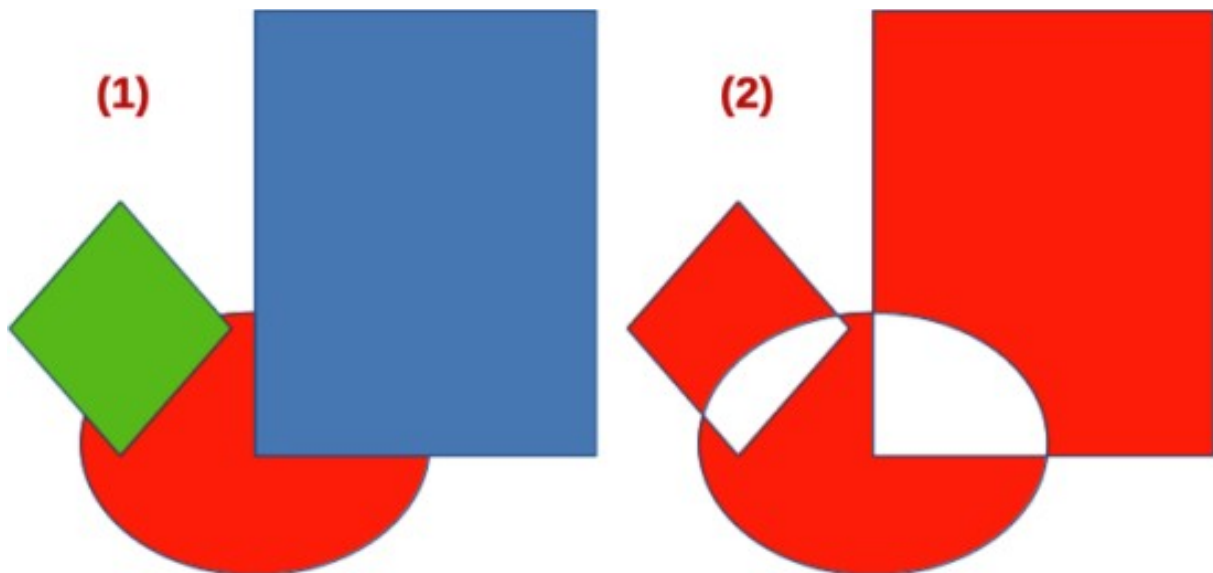

Figure 121: Example of area fill on combined objects

- 1) Overlapping individual objects
- 2) Combined overlapping objects

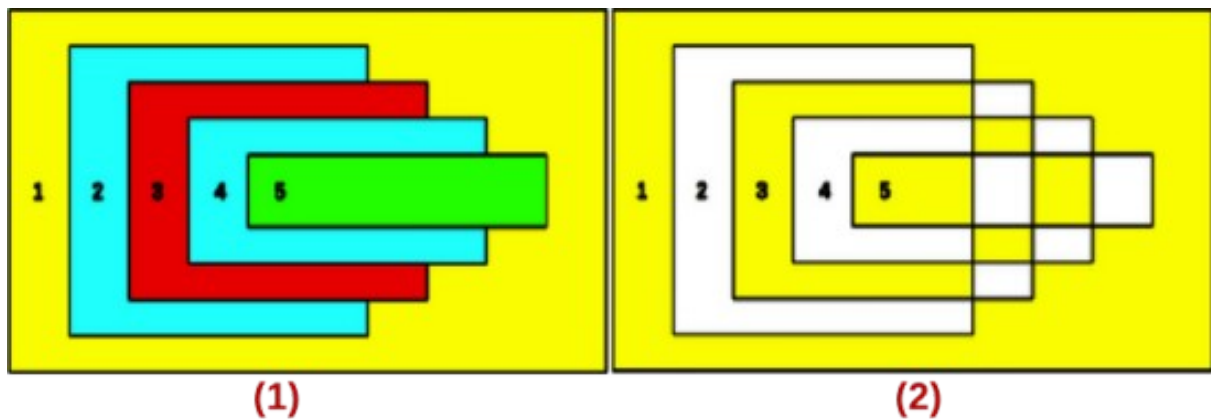

Figure 122: Example of area fill on combined objects

- 1) Overlapping individual objects 2) Combined overlapping objects

- 1) Combine the selected objects into a single object using one of the following methods:
 - Right-click on the selection and select **Shapes > Combine** from the context menu.
 - Go to **Shape > Combine** on the Menu bar.
 - Use the keyboard combination *Ctrl+Shift+K* (macOS *⌘+Shift+K*).

At first glance, the results can seem rather surprising, but the following explains how combining objects works.

- The attributes (for example, area fill) of the resulting object are those of the object furthest back. In Figure 121, it is the ellipse and in Figure 122 it is the yellow rectangle.
- Where objects overlap, the overlapping zone is either filled or empty depending on whether the overlap is even numbered or odd numbered. Figure 122 shows where the overlap number is even, an empty space is created and where the overlap number is odd, a filled area is created.

Splitting combined objects

An object which has been created from combining several objects can be split into individual objects. However, the original objects retain the formatting of the combined object and do not revert back to their original formatting.

Select the combined object and use one of the following methods to split the combined object:

- Go to **Shape > Split** on the Menu bar.
- Use the keyboard shortcut *Ctrl+Alt+Shift+K* (macOS *⌘+⌥+Shift+K*).

In Figure 123, the left graphic is the original example of overlapping area fills before combining. The right graphic is the result of splitting the combined object. The individual overlapping objects have taken the formatting of the object (Rectangle 1) at the rear of the overlapping objects.

Breaking objects

An object that consists of more than one part can be broken into its individual parts as follows. For example, a star is broken into separate lines and the area fill is lost, as shown by the center graphic in Figure 124.

- 1) Select an object that consists of more than one part.

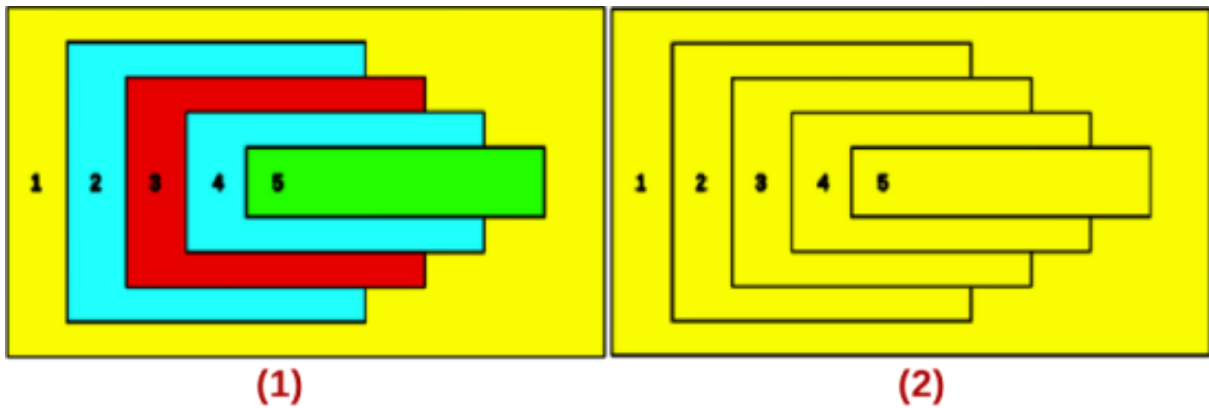

Figure 123: Example of splitting combined objects

- 1) Overlapping objects before combining 2) Split result of combined overlapping objects



Figure 124: Example of breaking an object

- 1) Original object 2) Object broken 3) Individual parts edited

- 1) Convert the object to a curve or polygon using one of the following methods:
 - Go to **Shape > Convert > To Curve** or **To Polygon** on the Menu bar.
 - Right-click on the object and select **Convert > To Curve** or **To Polygon** on the context menu.
- 2) Go to **Shape > Break** on the Menu bar and the object is broken into individual parts.
- 3) Move, format or delete the individual parts as necessary, as shown by the right object in Figure 124.

Connecting lines

The individual parts of an object or individual objects can be connected together as follows:

- 1) Select all the objects that are going to be connected.
- 2) Go to **Shape > Connect** on the Menu bar. Individual lines or lines in a border are converted to curves and the end points of each line connected.

✓ Note

The shape created when connecting individual parts or lines is not a closed shape. The new shape has to be closed to create an area fill.

Closing objects

Closing objects creates an object that uses an area fill.

- 1) Select an object that has a gap in its border.
- 2) Right-click on the selected object and select **Close Object** from the context menu to close the gap.
- 3) Format the area fill created to requirements. See Chapter 4, Changing Object Attributes for more information on working with area fills.

Merging, subtracting, or intersecting objects

After selecting more than one object, the merge, subtract, and intersect functions become available allowing creation of a new object with a new shape.

Merge

When merging objects, a new object is created with a shape that follows the shape of the merged objects. The area fill of the merged object is determined by the area fill of the object that is at the rear of all the other objects, as shown in Figure 125.

After selecting several objects, use one of the following methods to merge the objects:

- Go to **Shape > Merge** on the Menu bar.
- Right-click on the selected objects and select **Shapes > Merge** from the context menu.

Subtract

When subtracting objects, the objects at the front are subtracted from the object behind. This leaves a blank space the subtracted objects occupied creating a new shape, as shown in Figure 126. After selecting several objects that overlap each other, use one of the following methods to subtract objects:

- Go to **Shape > Subtract** on the Menu bar.
- Right-click on the selected objects and select **Shapes > Subtract** from the context menu.

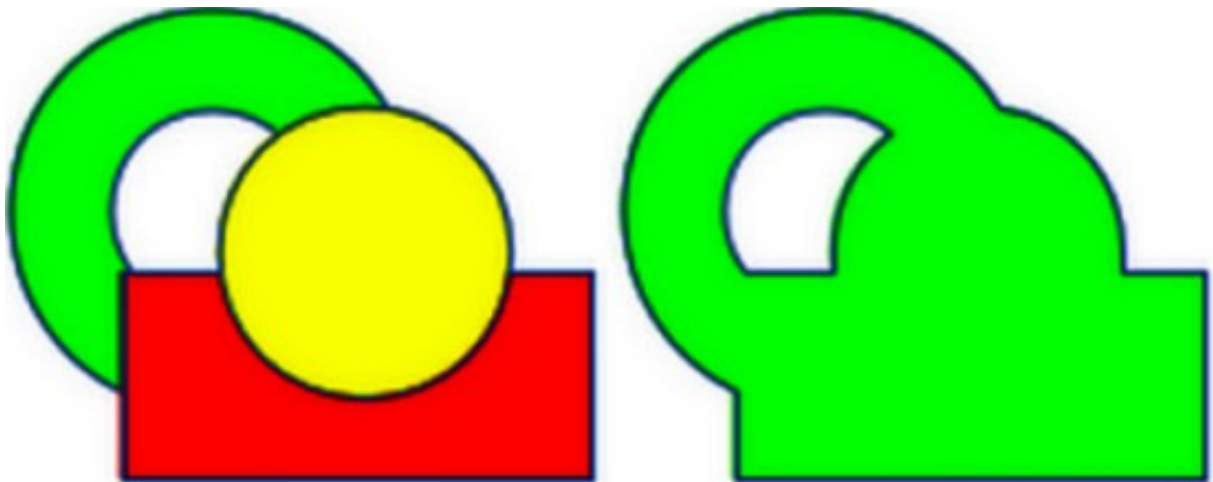

Figure 125: Example of merging objects

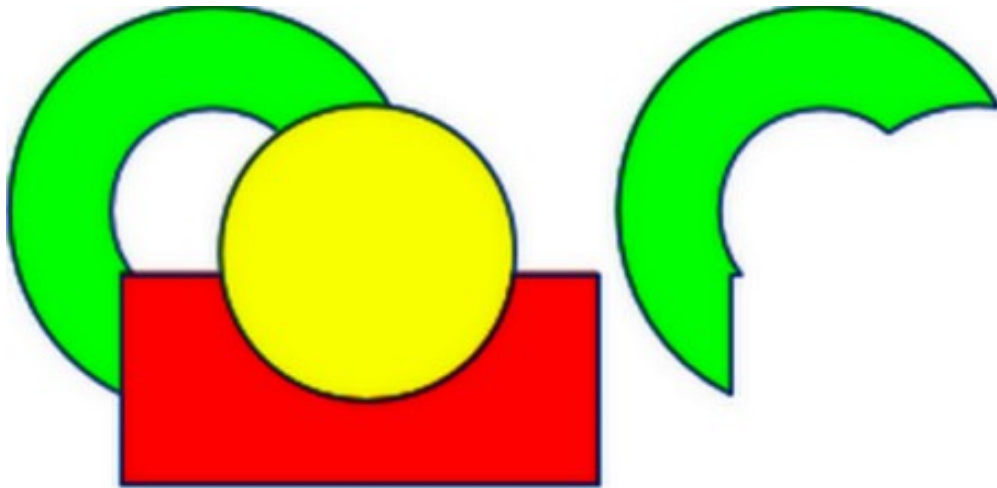

Figure 126: Example Of subtracting objects

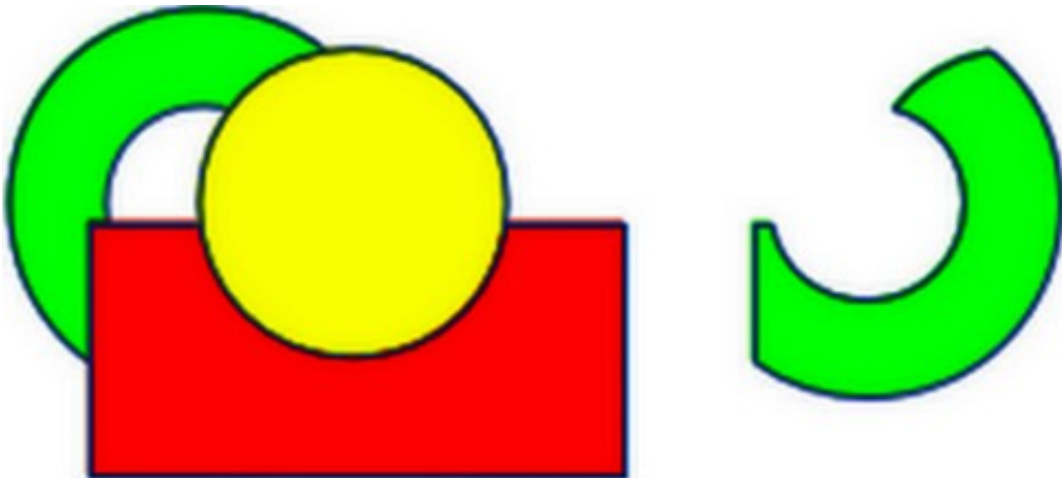

Figure 127: Example of intersecting objects

Intersect

When intersecting objects, the front objects and the exposed area of the rear object are removed. This creates a new object from the area of the rear object that was covered by the front objects, as shown in Figure 127. After selecting several objects that overlap each other, use one of the following methods to intersect objects:

- Go to **Shape > Intersect** on the Menu bar.
- Right-click on the selected objects and select **Shapes > Intersect** from the context menu.

Practical example

The following example shows how to use the merge, subtract, and intersect functions to create a knife with a wooden handle.

- 1) Draw an ellipse and then a rectangle overlapping half of the ellipse width.



- 2) Select both shapes and select **Shapes > Subtract** on the Menu bar.



- 3) Draw another rectangle and put it over the top half of the ellipse.

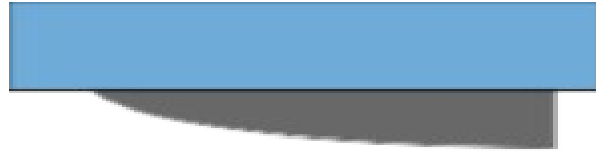

- 4) Select both shapes and select **Shapes > Subtract** on the Menu bar.



- 5) Draw a small ellipse covering just the lower right corner.



- 6) Select both shapes and select **Shapes > Subtract** on the Menu bar. The knife blade shape is now complete.



- 7) To make the handle, draw a rectangle and an ellipse.



- 8) Merge the shapes together.



- 9) Position the handle on the blade. Select the handle and blade, then group together to create a drawing of the knife.



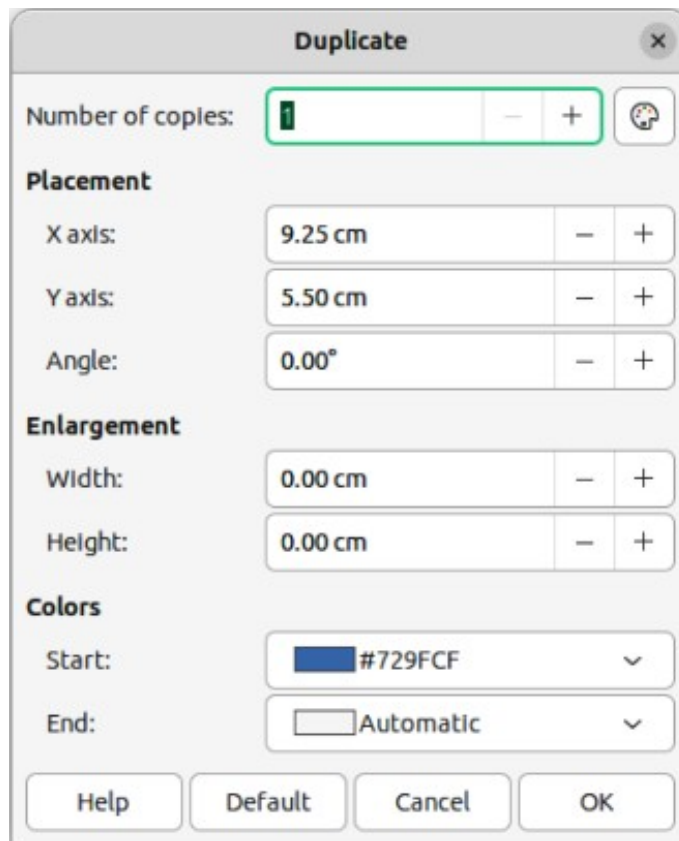

Figure 128: Duplicate dialog

Duplication and cross-fading

Duplication

Duplication makes copies of an object while applying a set of changes to the duplicate copies, such as color or rotation.

- 1) Select an object or group of objects, then use one of the following methods to open the Duplicate dialog (Figure 128):
 - Go to **Edit > Duplicate** on the Menu bar.
 - Go to **Shape > Duplicate** on the Menu bar.
 - Use the keyboard shortcut *Shift+F3*.
- 2) Select the number of copies, placement, enlargement, and the start and end colors for the duplicate copies.
- 3) Click **OK** and duplicate copies are created. An example of a duplication is shown in Figure 129. Each duplicate object is a separate object.
- 4) To group the duplicate objects into one group, see “Grouping objects” on page 124.
- 5) To combine the duplicate objects into one object, see “Combining, splitting, breaking, and connecting” on page 126.

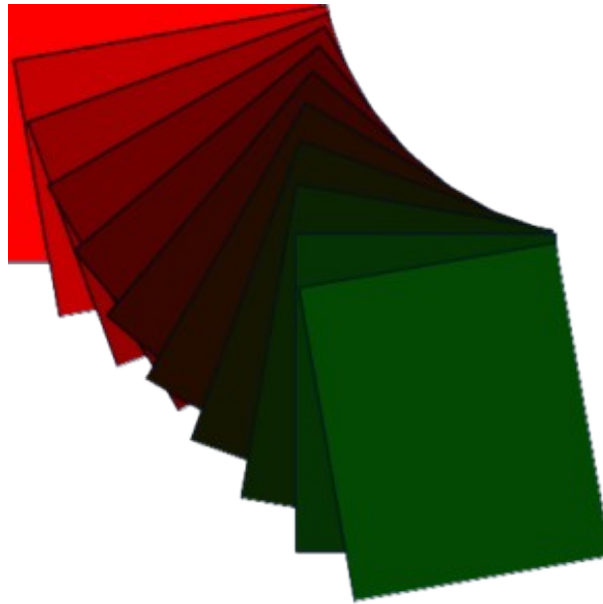

Figure 129: Example of duplication

The following options are available when using the Duplicate dialog:

Number of copies

Enter the number of copies required.

Placement

Sets the position and rotation of duplicated objects in relation to the original object.

X axis

Enter the horizontal distance between the centers of the selected object and the duplicate objects. Positive values shift the duplicate object to the right and negative values shift the duplicate object to the left.

Y axis

Enter the vertical distance between the centers of the selected object and the duplicate objects. Positive values shift the duplicate object down and negative values shift the duplicate object up.

Angle

Enter the angle (0 to 359 degrees) required for rotating the duplicate object. Positive values rotate the duplicate objects in a clockwise direction and negative values in a counterclockwise direction.

Enlargement

Sets the size of the duplicate objects.

Width

Enter the amount to enlarge or reduce the width of the duplicate objects.

Height

Enter the amount to enlarge or reduce the height of the duplicate objects.

Colors

Sets the colors for the selected object and the duplicate objects. For more than one copy, these colors define the start and end points of a color gradient.

Start

Select a color for the selected object.

End

Select a color for the duplicate object. If making more than one copy, this color is applied to the last copy.

Cross-fading

Cross-fading transforms one object shape into another object shape. The result is a new group of individual objects that includes the start and end objects. The intermediate steps show the transformation from one object shape to another object shape. The cross-fading is carried out from the first object selected to the second object selected.

- 1) Select two objects and go to **Shape > Cross-fading** on the Menu bar to open the Cross-fading dialog (Figure 130).
- 2) In **Settings**, select the number of *Increments* for the transformation.
- 3) If necessary, in **Settings**, select *Cross-fade attributes* and *Same orientation*.
- 4) Click **OK** to cross-fade the selected objects and close the Cross-fading dialog. An example of cross-fading is shown in Figure 131 with *Same orientation* deselected. The object created is a group of objects.
- 5) To ungroup this group of objects and use the individual objects, see “Ungrouping” on page 125.

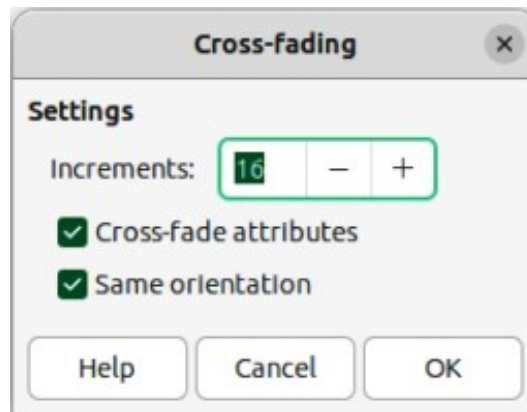

Figure 130: Cross-fading dialog

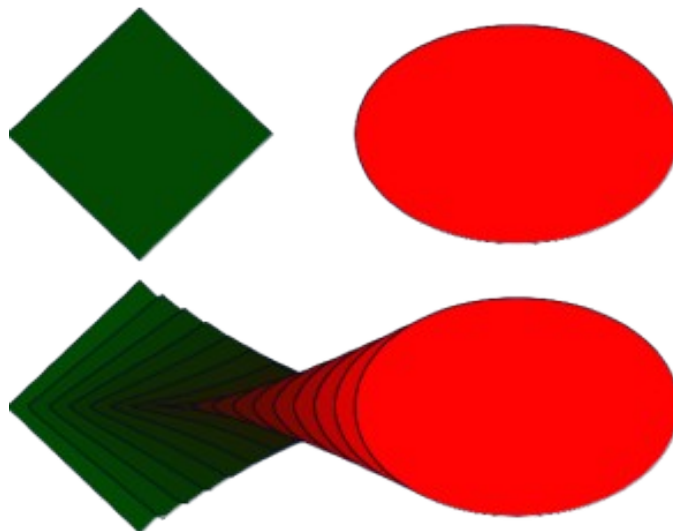

Figure 131: Example of cross-fading objects

The following options are available in the Cross-fading dialog:

Increments

Enter the number of steps created between the selected objects.

Cross-fade attributes

Applies cross-fading to the line and fill properties of the selected objects. For example, if the selected objects are filled with different colors, a color transition between the two colors is applied.

Same orientation

Applies a smooth transition between the selected objects.

Positioning objects

Arranging objects

When combining, merging, subtracting, or intersecting objects, the end result varies depending on which object is at the front and which object is at the back. Each new object placed on a drawing automatically becomes the front object and all the other objects move backwards in positioning order. Arranging objects changes the order of a group of objects.

To change the arrangement position of an object, select one or more objects and then use one of the following methods

- Right-click on the selected object(s), then select **Arrange** from the context menu and one of the available options.
- Click on the triangle ▼ to the right of **Arrange** on the Standard toolbar to open the Position sub-toolbar (Figure 132) and select one of the available tools.
- Click one of the arrangement tools on the Line and Filling toolbar.
- Click on **Shape > Arrange** on the Menu bar and select an arrangement option.
- Use the *Arrange* tools in **Position and Size** panel in the Properties deck on the Sidebar.
- Use a keyboard shortcut available for each arrange option.

The arrangement options available are as follows:

Bring to Front

Brings the selected object to the front of a group of objects (*Shift+Ctrl++*) (macOS *⌘+Shift++*).

Bring Forward

Brings the selected object forward one step (*Ctrl++*) (macOS *⌘++*).

Send Backward

Sends the selected object one step backward (*Ctrl+-*) (macOS *⌘+-*).

Send to Back

Sends the selected object to the back of a group of objects (*Shift+Ctrl+-*) (macOS *⌘+Shift+-*).

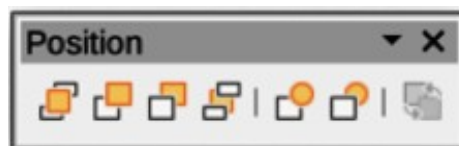

Figure 132: Position sub-toolbar



Figure 133: Align Objects toolbar

In Front of Object

Moves the selected object in front of another selected object.

Behind Object

Moves the selected object behind another selected object.

Reverse

Reverses the order of the selected objects. This tool is grayed out if only one object is selected.

Aligning objects

To make a drawing look more professional, objects can be aligned with each other. Select one or more objects and use one of the following methods to align objects:

- Right-click on the selected object(s), then select **Align Objects** from the context menu and one of the available options.
- Click on one of the alignment tools on the Line and Filling toolbar.
- Go to **Shape > Align Objects** on the Menu bar and select the alignment required.
- Use the *Align* tools in the **Position and Size** panel in the Properties deck on the Sidebar.
- Go to **View > Toolbars** on the Menu bar and select **Align Objects** to open the Align Objects toolbar (Figure 133).

The alignment tools available are as follows:

Left

Aligns the left edges of the selected objects. If only one object is selected, the left edge of the object is aligned to the left page margin.

Centered

Horizontally centers the selected objects. If only one object is selected, the center of the object is aligned to the horizontal center of the page.

Right

Aligns the right edges of the selected objects. If only one object is selected, the right edge of the object is aligned to the right page margin.

Top

Vertically aligns the top edges of the selected objects. If only one object is selected, the top edge of the object is aligned to the top page margin.

Center

Vertically centers the selected objects. If only one object is selected, the center of the object is aligned to the vertical center of the page.

Bottom

Vertically aligns the bottom edges of the selected objects. If only one object is selected, the bottom edge of the object is aligned to the bottom page margin.

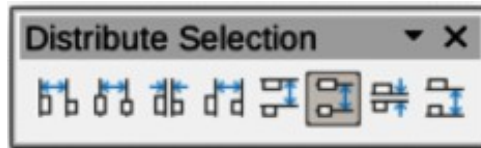

Figure 134: Distribute Selection toolbar

Distributing objects

Distributing objects allows three or more objects to be evenly spaced along a horizontal or vertical axis. Objects are distributed using the outermost objects in the selection as base points for spacing.

Select at least three objects, then use one of the following methods to distribute the objects:

- Right-click on the selected objects, then select **Distribute Selection** from the context menu and one of the available options.
- Go to **View > Toolbars** on the Menu bar and select **Distribute Selection** to open the Distribute Selection toolbar (Figure 134).
- Go to **Shape > Distribute Selection** on the Menu bar and select a distribution option.
- Right-click on the selected objects and select **Distribute Selection** from the context menu, then select a distribution option.

The distribution options available are as follow:

Horizontal Left

Distributes the selected objects so that the left edges of the objects are evenly spaced from one another.

Horizontal Center

Distributes the selected objects so that the horizontal centers of the objects are evenly spaced from one another.

Horizontal Spacing

Distributes the selected objects horizontally so that the objects are evenly spaced from one another.

Horizontal Right

Distributes the selected objects so that the right edges of the objects are evenly spaced from one another.

Vertical Top

Distributes the selected objects so that the top edges of the objects are evenly spaced from one another.

Vertical Center

Distributes the selected objects so that the vertical centers of the objects are evenly spaced from one another.

Vertical Spacing

Distributes the selected objects vertically so that the objects are evenly spaced from one another.

Vertical Bottom

Distributes the selected objects so that the bottom edges of the objects are evenly spaced from one another.



LibreOffice
Community



Draw Guide 7.5

Chapter 6, Editing Images

Raster Graphics

Introduction

Previous chapters in this Draw Guide have dealt only with vector graphics and the most common types of vector graphics in use are as follows:

SVG (Scalable Vector Graphics)

An Extensible Markup Language (XML) based vector image format for two-dimensional graphics with support for interactivity and animation.

EPS (Encapsulated PostScript)

A PostScript document format usable as a graphics file format. EPS files are self contained, PostScript documents that describe an image or drawing and can be placed within another PostScript document.

AI (Adobe Illustrator)

A proprietary file format developed by Adobe Systems for representing single-page vector-based drawings in either the EPS or PDF formats.

Draw also contains a number of functions for handling raster graphics or bitmaps such as photographs and scanned pictures, including import, export, and conversion from one format to another.

Draw can read the majority of graphic file formats using a subset of capabilities similar to raster graphics programs like Gimp or Adobe Photoshop. Raster graphics are generally images or pictures that use the most common formats in use:

JPG/JPEG (Joint Photographic Experts Group)

JPEG is the most common image format on websites and most digital cameras produce JPEG images as default.

GIF (Graphics Interchange Format)

GIF is a bitmap image format that is popular because of its wide support and portability.

PNG (Portable Network Graphics)

PNG is a raster image format which supports lossless data compression and also background transparency.

TIF/TIFF (Tagged Image File Format)

TIFF is flexible, adaptable, and capable of storing image data in a lossless format.

BMP (BitMaP)

Also known as bitmap image file, which is a dot matrix data structure.

Importing images

Inserting

To import image files into a drawing, go to **Insert > Image** on the Menu bar to open the Insert Image dialog (Figure 135).

Draw contains import filters for the majority of graphic formats. If the file being imported uses a graphic format not covered by the import filters, it is recommended to use one of the many free graphic conversion programs to convert the file into a format that Draw recognizes.

If **Preview** is selected, a preview of the file is shown on the right-hand side of the Insert Image dialog. This makes it easier to select the file required and also checks that Draw can import the file format used.

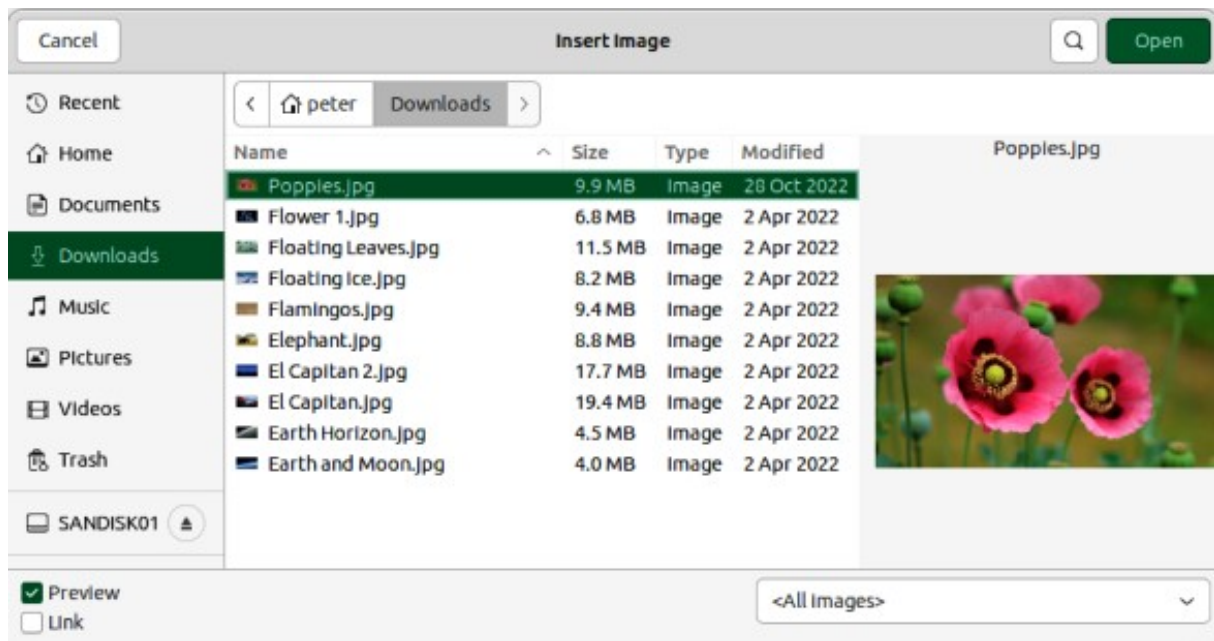

Figure 135: Insert Image dialog

Embedding

Embedding a graphic into a drawing makes it a permanent part of the drawing. Any changes made to an embedded graphic only appear in the drawing where the graphic has been embedded. The original graphic file is not affected. Embedding happens when a graphic is imported into a drawing using one of the following methods:

- Insert Image dialog.
- Copying and pasting.
- Scanning a graphic.
- Dragging and dropping between open files.

The main advantage of embedding graphics into a drawing is that the graphic is always available no matter what computer is used to open the drawing.

The main disadvantage of embedding graphics is that it creates large file sizes, which may not be desirable if there is limited storage capacity on a computer. Also, if the original graphic is altered, then the embedded graphic is not updated each time the drawing is opened.

Note

When a graphic is embedded into a LibreOffice drawing, make sure that **Insert as Link** is not selected in the Insert Image dialog.

Linking

Linking to the original graphic does not insert the graphic into a drawing, but creates a link to where the original graphic file is located. Each time the drawing is opened, any linked graphics are displayed in the drawing.

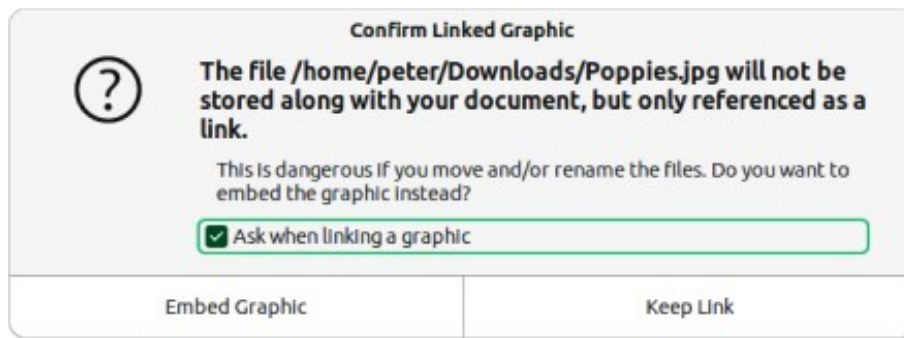

Figure 136: Confirm Linked Graphic dialog

The main advantage of linking a graphic file when inserted into a drawing is that if the original graphic file is altered or replaced with a graphic using the same filename, the version of the graphic in the drawing is always up to date. The next time the drawing is opened, the latest version of the graphic is also opened in the drawing. Also the file size of the drawing is much smaller and the original graphic is easily edited with specialized external applications.

The main disadvantage of linking graphics is that the link must be maintained between the drawing and the embedded graphic file for linking to work correctly. If the original drawing or graphic file is moved to another computer location, then any links must be updated to include the new location.

- 1) Open the Insert Image dialog.
- 2) Select **Insert as Link** in the Insert Image dialog.
- 3) Select the required graphic file and click on **Open** to open the Confirm Linked Graphic dialog (Figure 136).
- 4) Click on **Keep Link** to link the file and close the Confirm Linked Graphic dialog.
- 5) If necessary, click on **Embed Graphic** to embed the file instead of linking the file. This also closes the Confirm Linked Graphic dialog.

Note

When a graphic file is linked to a LibreOffice drawing, the format of the linked graphic is not changed.

Editing links

Links can be updated, modified, or broken as follows:

- 1) Go to **Edit > External Links** on the Menu bar to open the Edit Links dialog (Figure 137) and select the link to be edited.
- 2) Click on **Modify**, **Break Link**, or **Update** as appropriate.
 - **Modify** — changes the graphic file in the drawing and the source file for the selected link.
 - **Break Link** — breaks the link between the selected file and the current document. The version of the graphic file in the drawing becomes embedded into the drawing. A confirmation dialog opens asking if the link is to be broken. Click on **Yes** to confirm the breaking of the link.
 - **Update** — updates the selected link so that the most recent version of the linked file is displayed in the drawing.
- 3) Click on **Close** to save the changes to the link and close the Edit Links dialog.

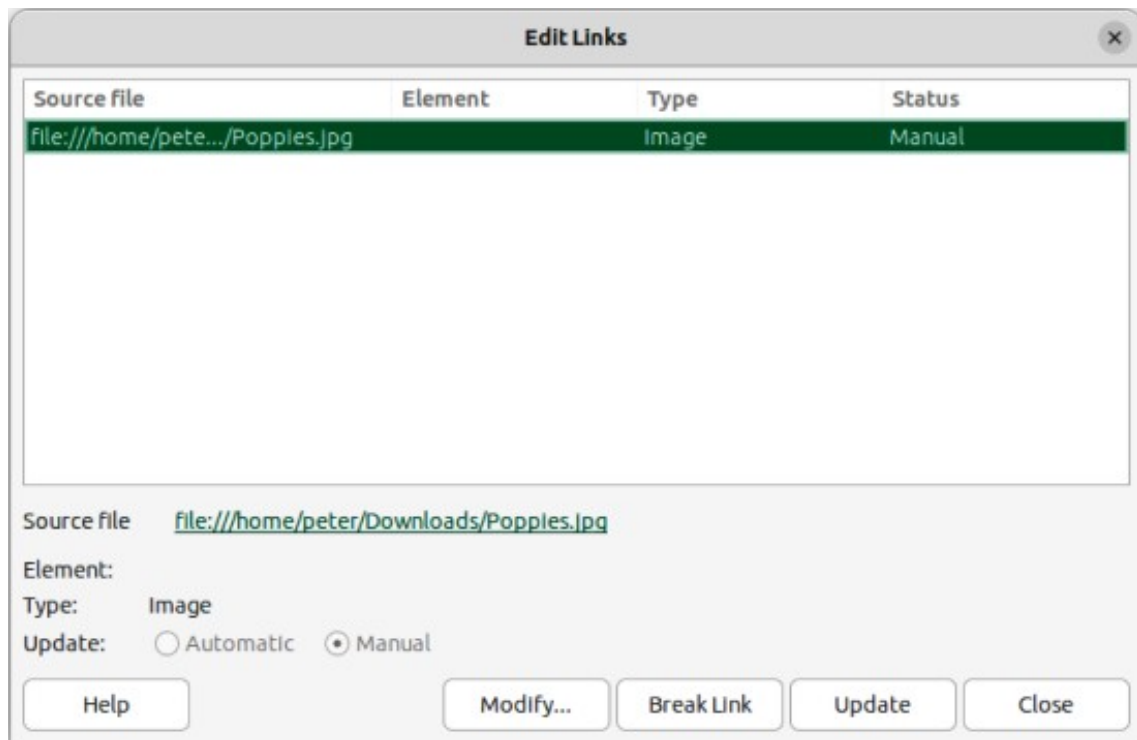

Figure 137: Edit Links dialog

Scanning

After scanning, the scanned images are inserted and embedded using PNG format into a drawing or document. To insert scanned images, make sure the scanner is configured for the computer and supported by the following systems:

- SANE for a Linux operating system.
- TWAIN for a Windows or Mac operating system.

The following procedure is an example only. The actual scanning procedure depends on the scanner driver, interface, and computer operating system. Consult the scanner documentation for more information.

- 1) Place a document, drawing, or photograph in the scanner and make sure that the scanner is switched on and ready.
- 2) If this is the first time the scanner has been used with LibreOffice, go to **Insert > Media > Scan > Select Source** on the Menu bar to select the scanner.
- 3) If the scanner has been used before, go to **Insert > Image > Scan > Request** on the Menu bar.
- 4) Specify the scanning resolution, subject being scanned, and so on.
- 5) When the image has been scanned, Draw places it in the drawing. At this point the scanned image can be edited like any other graphic.

✓ Note

If more than one scanning device is connected to the computer, the device is selected when the source is selected. This selection becomes the default source for scanning until another scanner is selected and used as the scanning source.

Copying and pasting

Copying and pasting a graphic also embeds a graphic file into a drawing. A copied graphic can be an image already embedded in another document or drawing, or it can be a graphic file such as a drawing, document, or photograph.

- 1) After copying the graphic file, go to **Edit > Paste Special > Paste Special** on the Menu bar to open the Paste Special dialog.
- 2) Select the required format for pasting the copied graphic into a drawing. Available formats for pasting depend on the type of file copied onto the clipboard.
- 3) Click **OK** to paste the graphic file and close the Paste Special dialog.

✓ Note

When copying and pasting images into a drawing, please respect the copyright and license of any file being copied.

Exporting images

Exporting files

By default Draw saves drawings in the Open Document format ODG and some software programs are not compatible with this format. To make drawings available for other programs, a file can be exported in various formats. The export procedure used depends on the computer setup and computer operating system being used. The following procedure is an example export procedure.

- 1) Open the ODG file being exported.

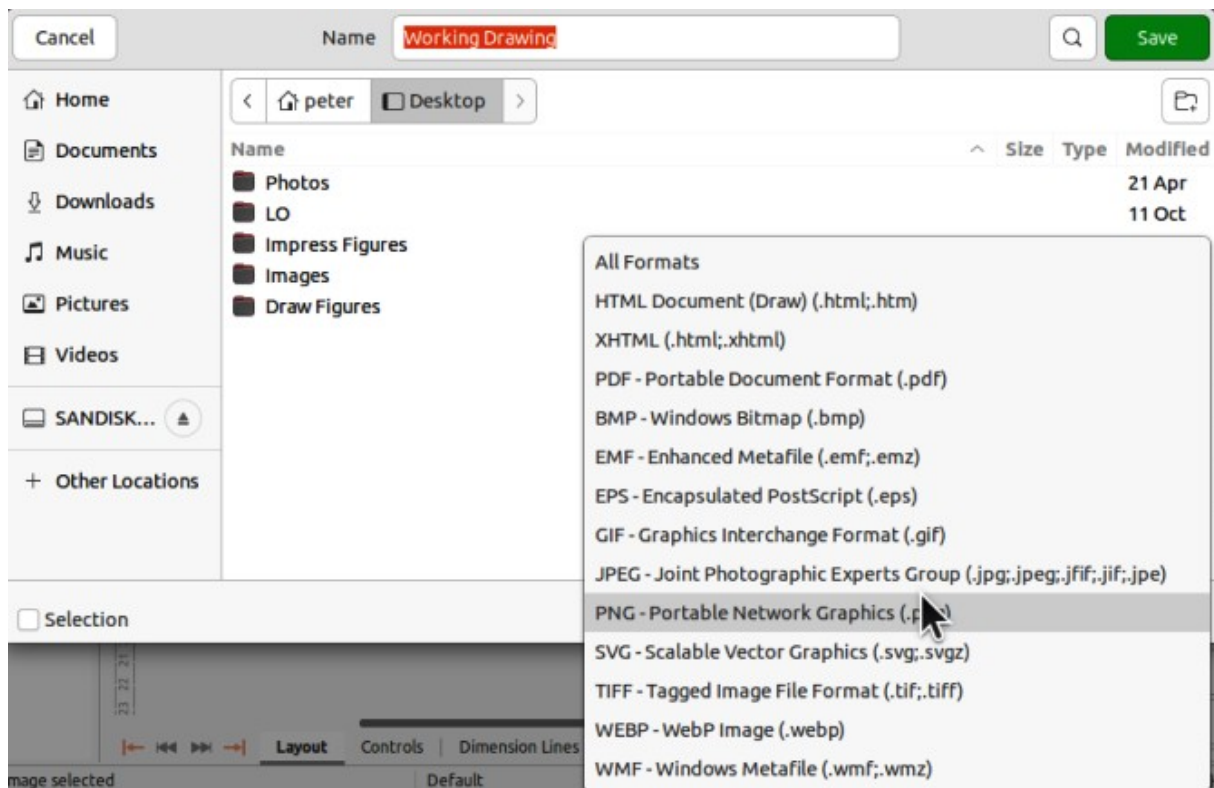

Figure 138: Example of an export dialog

- 2) Go to **File > Export** on the Menu bar and open the Export dialog. An example of an export dialog is shown in Figure 138.
- 3) Enter a new filename for the exported file and navigate to the folder where the exported file is to be saved.
- 4) Select the required file format from the options in the drop-down list.
- 5) Click **Export** and the file is exported as a new file in the selected file format.
- 6) Depending on the file format selected, another dialog may open allowing options to be selected for the export format.
- 7) Depending on the additional dialog that may open, click on **Export, Create, or OK** and the file is exported as a new file in its new format.

Exporting objects

Exporting individual objects, or a group of objects, from a drawing file is similar to “Exporting files” above. Open a drawing and select the object or objects for export. Make sure to choose the **Selection** option in the export dialog, as shown in Figure 138. Using this method, an imported image can be modified, annotations added to it, and make any other changes, then select it and export for use in another drawing or document.

Formatting images (raster objects)

Images (raster graphics) are edited and formatted to add or change filters and adjust the properties of color, lines, areas, and shadows using one of the following methods:

- Go to **Format > Image** on the Menu bar and use the tools in the sub-menu that opens.
- Use the tools on the Image toolbar (Figure 139). See “Image toolbar” below for more information.
- Use the tools available in the **Image** panel on the Properties deck of the Sidebar.
- Some raster graphics may have a text element. For more information on formatting text, see Chapter 9, Adding and Formatting Text.

✓ Notes

Formatting changes made to a graphic using the tools in LibreOffice only appear in the drawing where the graphic was modified. Original graphic file is not affected.

Raster graphics included in a group behave like other objects when the properties of the group are edited and formatted.

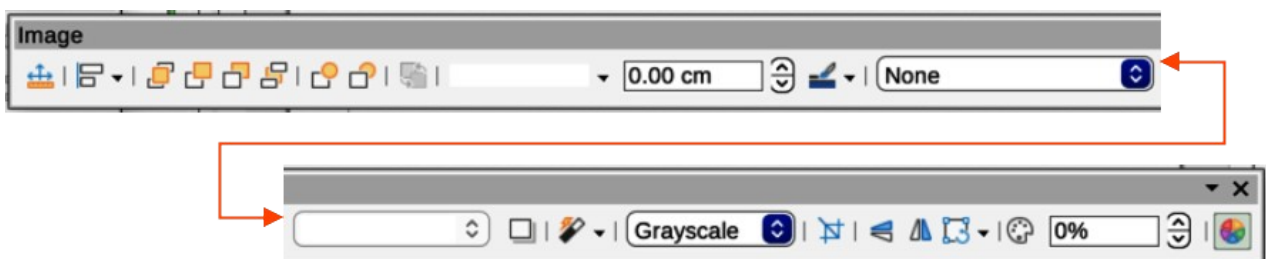

Figure 139: Image toolbar

Naming images

Draw names objects, including inserted images, Shape 1, Shape 2, and so on, using the insertion order into a drawing. It is recommended to rename objects, including images, using a unique name. Names make objects and images easily identifiable in the LibreOffice Navigator.

- 1) Select an image, then use one of the following methods to open the Name dialog and create a unique name for the selected image:
 - Go to **Format > Name** on the Menu bar.
 - Right-click on the image and select **Name** from the context menu.
- 2) Enter a name in the *Name* text box in the Name dialog that opens and click **OK**.

Image toolbar

The Image toolbar (Figure 139) appears when an image or object that is a raster graphic is selected. For more information on the Image toolbar and the available tools, see Appendix B, Toolbars. The tools listed below for the Image toolbar are an example only.

Position and Size (F4)

Opens the Position and Size dialog. See Chapter 3, Working with Objects for more information.

Align Objects

Opens a sub-toolbar giving access to alignment tools for aligning selected objects in relation to each other. See Chapter 5, Combining Multiple Objects for more information.

Bring to Front

Brings the selected object to the front of a group of objects (*Ctrl+Shift++*) (macOS *⌘+Shift++*).

Bring Forward

Brings the selected object forward one step (*Ctrl++*) (macOS *⌘++*).

Send Backward

Sends the selected object one step backward (*Ctrl+-*) (macOS *⌘+-*).

Send to Back

Sends the selected object to the back of a group of objects (*Ctrl+Shift+-*) (macOS *⌘+Shift+-*).

In Front of Object

Moves the selected object in front of another selected object.

Behind Object

Moves the selected object behind another selected object.

Reverse

Reverses the order of the selected objects. This tool is grayed out if only one object is selected.

Line Style

Opens a drop-down list with different line styles used for the outline of the border. See Chapter 4, Changing Object Attributes for more information.

Line Width

Used to change the width of a line. See Chapter 4, Changing Object Attributes for more information.

Line Color

Used to change the color of a line. See Chapter 4, Changing Object Attributes for more information.

Area Style/Filling

Used to change the type of filling used in a shape. See Chapter 4, Changing Object Attributes for more information.

Shadow

Sets the default shadow effect around the picture. The shadow attributes are adjusted using the **Shadow** panel in the Properties deck on the Sidebar. See Chapter 4, Changing Object Attributes for more information.

Filter

Opens the Image Filter toolbar which is described in “Image filters” on page 152.

Image Mode

Changes the display of the image from color to grayscale, black and white, or a watermark. This setting affects only the display and printing of the image; the original image file remains unchanged. The image mode setting can also be changed using *Color mode* in the **Image** panel in the Properties deck on the Sidebar (Figure 140).

Default

Image is displayed unaltered in color.

Grayscale

Image is displayed in 256 shades of gray.

Black/White

Image is displayed in black and white.

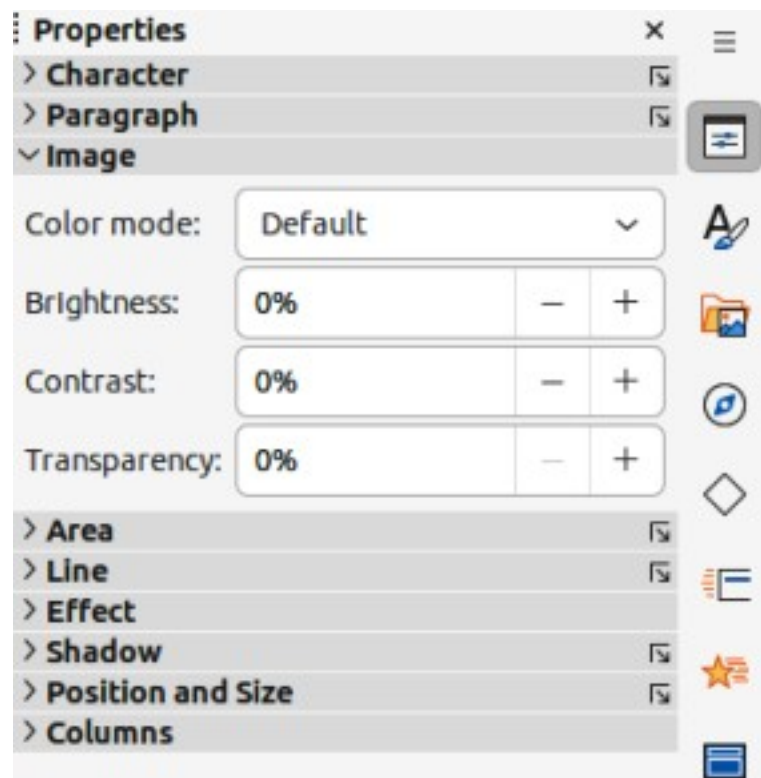

Figure 140: Image panel in Properties deck on Sidebar

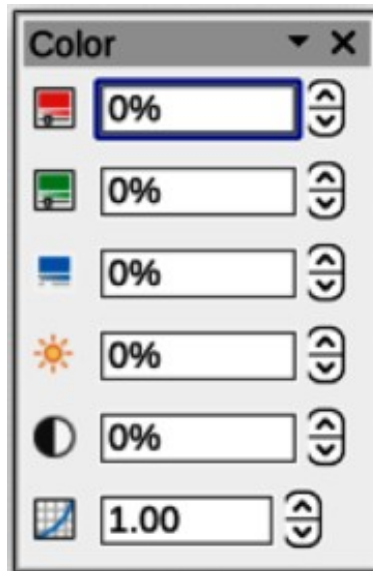

Figure 141: Color sub-toolbar

Watermark

Color, brightness, contrast, and gamma settings are reduced so that the image can be used as a watermark (background). The default settings for *Watermark* can be adjusted using the Color sub-toolbar (Figure 141).

Crop Image

Crops or trims an image. When using this tool, crop marks appear around the image. Drag one or more of these marks to crop the image to the desired size. For more information on cropping, see “Cropping images” on page 149.

Vertically

Flips the selected object vertically. See Chapter 4, Changing Object Attributes for more information.

Horizontally

Flips the selected object horizontally. See Chapter 4, Changing Object Attributes for more information.

Transformations

Opens the Transformations toolbar. See Chapter 4, Changing Object Attributes for more information.

Transparency

Adjusts the degree of transparency of the image between 0% (opaque) and 100% (fully transparent). The transparency setting can also be adjusted using the **Image** panel in the Properties deck on the Sidebar.

Color

Opens the Color sub-toolbar (Figure 141) to adjust the values of the RGB colors, brightness, contrast, and Gamma. These adjustments do not affect the original image, but the values are stored in Draw as a separate formatting set. The color settings can also be adjusted using the **Image** panel in the Properties deck on the Sidebar.

Red, Green, Blue

Select values between –100% (no color) to +100% (full intensity); 0% represents the original color value of the image.

Brightness

Select a value between –100% (totally black) and +100% (totally white).

Contrast

Select a value between –100% (minimum) and +100% (maximum).

Gamma

Affects the brightness of the middle color tones. Select a value between 0.10 (minimum) to 10 (maximum) Try adjusting this value if changing brightness or contrast does not give the required result.

Cropping images

Cropping is a method of hiding unwanted areas of an image or changing the size of an image in a drawing. Changes made when cropping an image only change the display of the image in a drawing and not the original image file.

Quick cropping

After selecting an image, it can be cropped quickly using one of the following methods:

- Click on **Crop Image** on the Standard or Image toolbar.
- Go to **Format > Image > Crop** on the Menu bar.
- Right-click on the image and select **Crop** from the context menu.

Selection handles appear around the selected image (Figure 142) and the image is cropped as follows:

- Top, bottom, left, and right selection handles crop the image in one direction only.
- Corner selection handles crop the image vertically and horizontally in two directions.
- To maintain the ratio between vertical and horizontal dimensions, hold down the *Shift* key while moving a selection handle.

Crop dialog

For more control and accuracy over the cropping functions, it is recommended to use the Crop dialog (Figure 143). Select an image and go to **Format > Image > Crop Dialog** on the Menu bar to open the Crop dialog.



Figure 142: Example image in crop mode

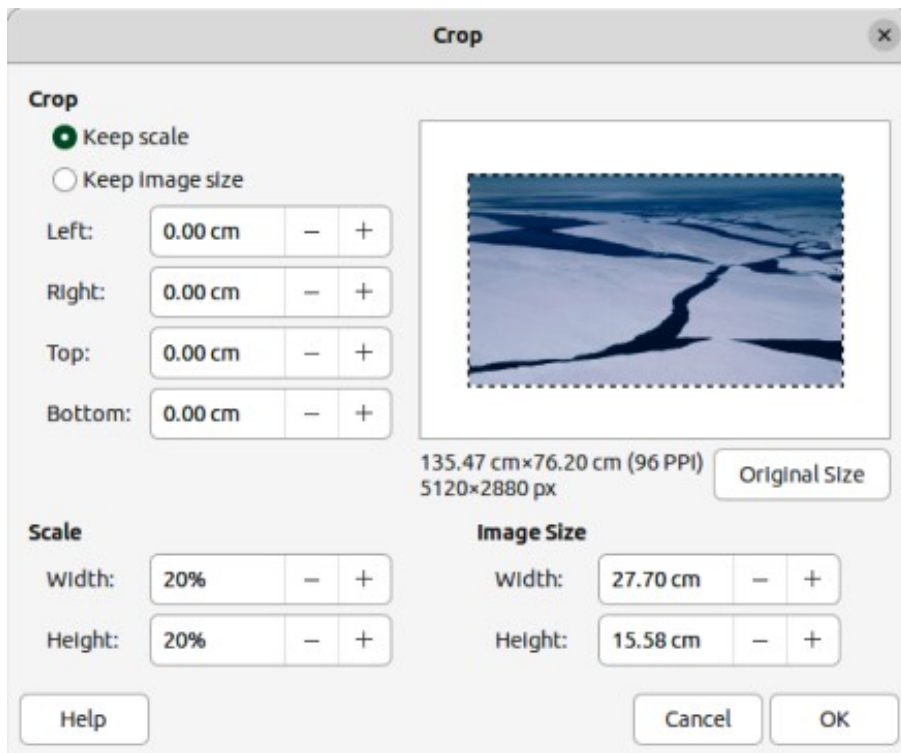

Figure 143: Crop dialog

Crop

Trim or scale the selected image, or add white space around the image.

Keep scale

Maintains the original scale of the image when cropping so that only the size of the image changes.

Keep image size

Maintains the image original size when cropping so that only the image scale changes. To reduce the image scale, select this option and enter negative values in the cropping boxes. To increase the image scale, enter positive values in the cropping boxes.

Left and Right

If *Keep scale* is selected, enter a positive amount to trim the left or right edge of the image, or a negative amount to add white space to the left or right of the image. If *Keep image size* is selected, enter a positive amount to increase the image horizontal scale, or a negative amount to decrease the image horizontal scale.

Top and Bottom

If *Keep scale* is selected, enter a positive amount to trim the image top or bottom, or a negative amount to add white space above or below the image. If *Keep image size* is selected, enter a positive amount to increase the image vertical scale, or a negative amount to decrease the image vertical scale.

Scale

Used to change the image scale as it appears in a drawing.

Width

Enter a percentage value to change the image width.

Height

Enter a percentage value to change the image height.

Image Size

Used to change the image size.

Width

Enter a value for the image width.

Height

Enter a value for the image height.

Original Size

Original size of the image is displayed above the option. Clicking on this option and then clicking **OK** resets the selected image to its original size.

Note

In the Crop dialog, the *Width* and *Height* are treated as independent values. Changing one without the other can result in significant distortion of the image and this may not be what is required.

Exporting cropped images

If a cropped image is to be used in another drawing, use one of the following methods after selecting the cropped image:

- Go to **File > Export** on the Menu bar to open the Export dialog. Navigate to the destination folder, then enter a filename, choose the **Selection** option, and click on **Export**. See “Exporting images” on page 144 for more information.
- Go to **Format > Image > Save** on the Menu bar or right click on the cropped image and select **Save** from the context menu. Click on **Yes** to save the modified image and open an Image Export dialog. Select the file format required, navigate to the destination folder, then enter a filename and click on **Save**.

Compressing images

If a large image is inserted into a drawing and resized to fit into the layout of the drawing, the complete full-size original image is stored in the drawing file. This preserves the original image, possibly resulting in a large file to store or send by mail.

If some loss of image quality can be accepted, the image can be compressed reducing its data volume while preserving its display in the page layout;

- 1) Open the Compress Image dialog (Figure 144) using one of the following methods:
 - Right-click on the image and select **Compress** from the context menu.
 - Go to **Format > Image > Compress** on the Menu bar.
- 2) Select the type of compression and the resolution required.
- 3) Click on **Calculate New Size** to update the image information when the **Compression** and **Resolution** settings are changed.
- 4) When satisfied with the new settings, click **OK** to apply the settings.
- 5) If the resulting image is not acceptable, use one of the following methods to undo the changes and select another compression setting.
 - Keyboard shortcut *Ctrl*+*Z* (macOS *⌘*+*Z*).
 - Go to **Edit > Undo** on the Menu bar.

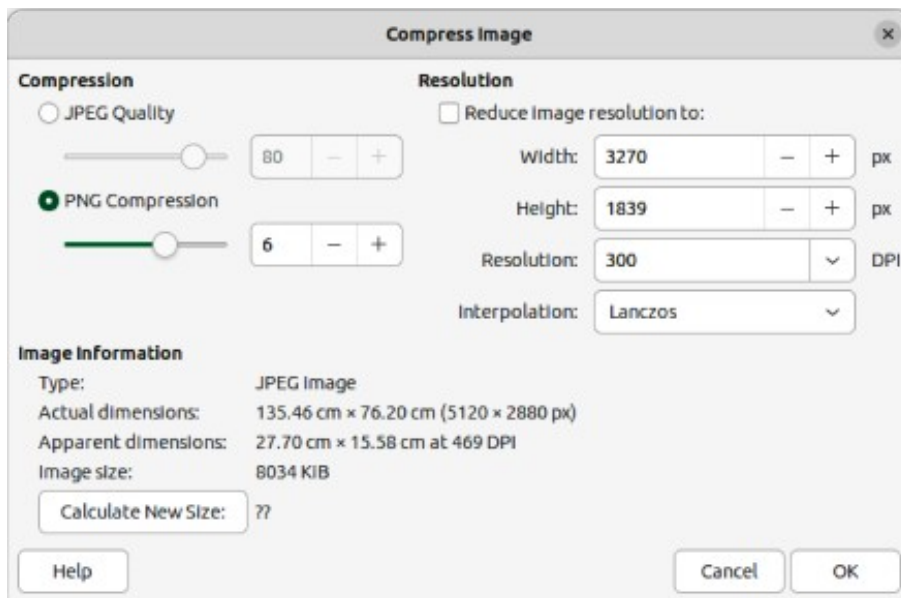

Figure 144: Compress Image dialog



Figure 145: Image Filter sub-toolbar

Image filters

Draw has eleven filter effects that work on selected images and these filters can be combined. Filters always apply to the entire image and it is not possible to use filters to edit only a part of the image.

- 1) Select an image to open the Image toolbar.
- 2) Apply an image filter using one of the following methods:
 - Click on **Filter** to open the Image Filter sub-toolbar (Figure 145), then select an image filter to apply.
 - Go to **Format > Image > Filter** on the Menu bar and select an image filter from the context menu.

✓ Notes

If an image is embedded into a drawing, any image filters are applied directly to the embedded image and the original image file is not changed. Save the drawing to retain any filter effects applied to the embedded image in a drawing.

After a drawing is saved and closed, the effects of image filters become permanent. If image filter effects are not satisfactory, use **Edit > Undo** on the Menu bar to cancel the filter effects before saving the drawing.

When applying image filters to an image, the file size of the image must be taken into account. On large file sizes, there is a time lag between applying an image filter and the effect to be visible on the image.



Figure 146: Example image — no filter

Figure 146 is an example of an image with no image filters applied. The image filters available on the Image Filter sub-toolbar are as follows with examples of the filter effect on the image.

Invert

Inverts or reverses the color values of a color image (similar to a color negative), or the brightness values of a grayscale image. Apply the filter again to revert to the original graphic (Figure 147).

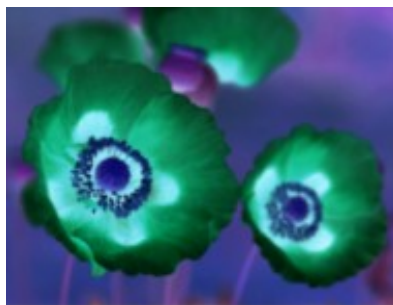

Figure 147: Example of Invert filter

Smooth

Softens or blurs the image by applying a low pass filter. This reduces the contrast between neighboring pixels and produces a lack of sharpness making the image appear smoother. The effect of the smooth filter can be very subtle. Figure 148 shows the effect of applying a *Smooth radius* of 15 to an image. Selecting this filter opens the Smooth dialog (Figure 149) where the smooth radius parameter is set. The preview in the Smooth dialog shows the effect of applying the Smooth filter to an image.



Figure 148: Example of Smooth filter

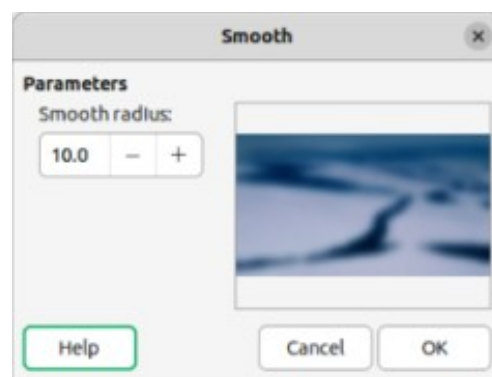

Figure 149: Smooth dialog

Sharpen

Sharpens the image by applying a high pass filter, adjusting the contrast between neighboring pixels. The effect increases if the filter is applied several times making the colors appear faded, as shown by the example in Figure 150.



Figure 150: Example of Sharpen filter

Remove Noise

Removes noise by applying a median filter comparing every pixel with its neighbor. It then replaces any pixel with extreme values that deviate in color by a large amount from the mean value with a pixel that has a mean color value. The amount of picture information does not increase each time the filter is applied. However, there are fewer contrast changes resulting in an image that looks smoother and the effect is very subtle (Figure 151).



Figure 151: Example of Remove Noise filter

Solarization

Solarization refers to an effect that looks when there is too much light during photo development and the colors have become partly inverted. Dark areas appear light or light areas appear dark. In the digital world of photography, solarization creates a change or reversal of color, similar to the effect of the **Invert** image filter. Figure 152 shows the effect of a Solarization filter applied using a threshold value of 50%.

Selecting **Solarization** opens the Solarization dialog (Figure 153), where the degree of solarization (*Threshold value*) can be specified. Entering a *Threshold value* above 70% reverses the inversion effect on colors. Also, selecting *Invert* reverses the effect of the **Solarization** image filter, as shown in the preview box in Figure 153.

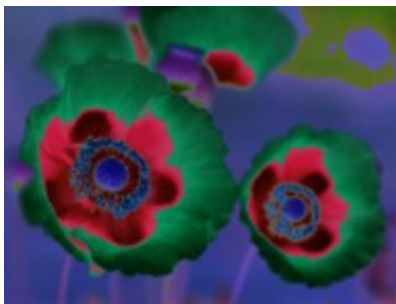

Figure 152: Example of Solarization filter

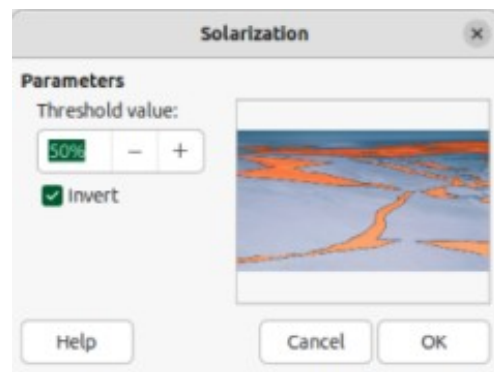

Figure 153: Solarization dialog

Aging

Aging creates a look that resembles photographs developed in the early days of photography (Figure 154). All pixels are set to their gray values and then the green and blue color channels are reduced by the amount specified in *Aging degree* in the Aging dialog. Red color channel is not changed.

Selecting the **Aging** filter opens the Aging dialog (Figure 155), where the *Aging degree* can be defined and create an old look for an image.

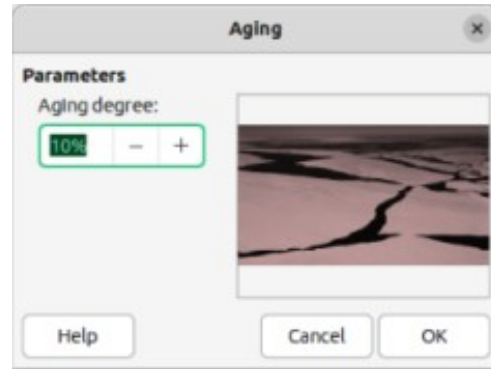

Figure 154: Example of Aging filter Figure 155: Aging dialog

Posterize

Posterizing reduces the number of colors in an image. For example, a photograph will probably look like a painting when the number of colors is reduced (Figure 156). Selecting **Posterize** opens the Posterize dialog (Figure 157), where the number of *Poster colors* can be defined to produce the effect required.

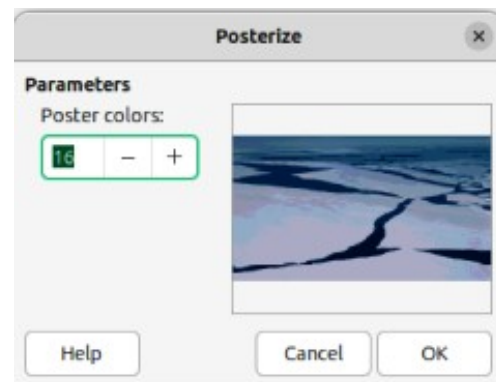

Figure 156: Example of Posterize filter Figure 157: Posterize dialog

Pop Art

Changes the colors of an image converting it to a pop-art format (Figure 158).



Figure 158: Example of Pop Art filter

Charcoal Sketch

Displays an image as a charcoal sketch. The contours of the image are drawn in black and the original colors are suppressed (Figure 159).

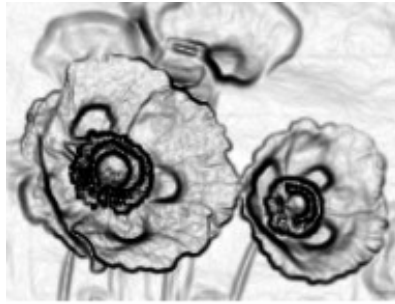

Figure 159: Example of Charcoal Sketch filter

Relief

Calculates the edges of an image in relief as if the image is illuminated by a light source (Figure 160). Selecting **Relief** opens the Emboss dialog (Figure 161) where the position of the *Light source* is selected producing shadows that differ in direction and magnitude.

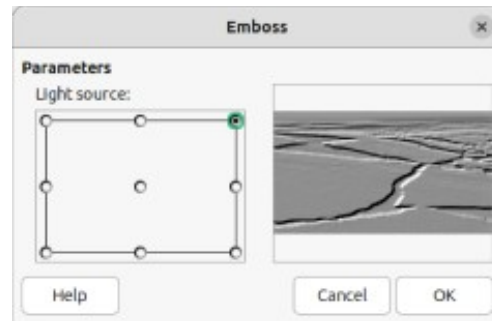
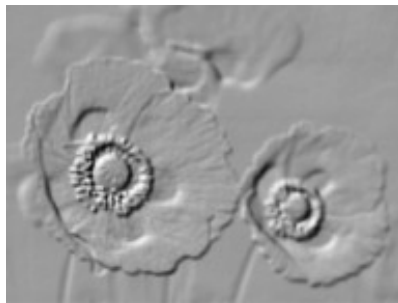

Figure 160: Example of Relief filter Figure 161: Emboss dialog

Mosaic

This image filter joins groups of pixels and converts them into rectangles of a single color creating an image that appears to be a mosaic (Figure 162). The larger the individual rectangles created, the fewer details in the mosaic graphic.

Selecting this image filter opens the Mosaic dialog (Figure 163), where the number of pixels for *Width* and *Height* of the tiles is set. Selecting *Enhanced edges* enhances the edges of each tile, creating a sharper definition.



Figure 162: Example of Mosaic filter

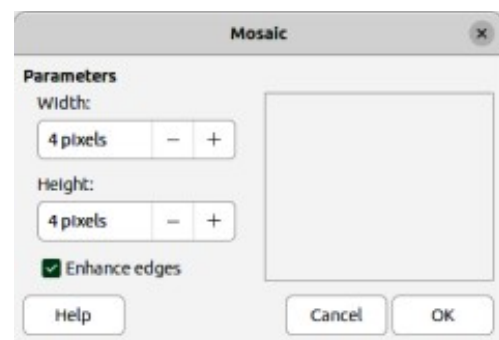

Figure 163: Mosaic dialog

Replacing colors

The **Color Replacer** allows replacement or changing a color in an embedded graphic for another color, or set a color as transparent. Up to four colors can be replaced at once. An area of the graphic cannot be selected for editing as this tool only works on the entire graphic.

The replacement colors selection can only be from one of the available palettes in LibreOffice. New colors cannot be defined here, but custom colors can be created before using the **Color Replacer**. For more information on creating colors, see Chapter 11, Advanced Draw Techniques.

✓ Note

The **Color Replacer** can only be used on embedded graphics. If the **Color Replacer** is used on a linked graphic, the following error message appears “*This image is linked to a document. Do you want to unlink the image in order to edit it?*”. Click on **Yes** to unlink and embed the graphic.

Color Replacer dialog

Pipette

Switches color selection on when selected.

Replace

Replaces the selected source colors in the selected image with the colors specified in the *Replace with* boxes.

Colors

Lists the source colors and the replacement colors.

Source color

Select this checkbox to replace the current *Source color* with the color that specified in the *Replace with* box.

Tolerance

Set the tolerance for replacing a source color in the source image. To replace colors that are similar to the color selected, enter a low value. To replace a wider range of colors, enter a higher value.

Replace with

Lists the available color palettes and replacement colors.

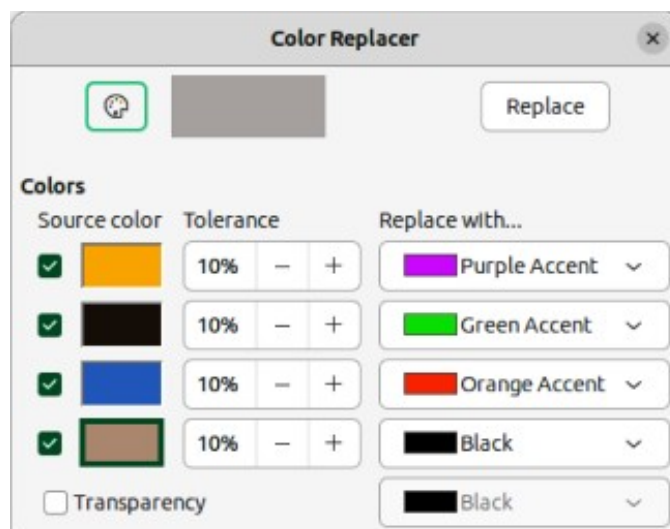

Figure 164: Color Replacer dialog

Transparency

Replaces transparent areas in the selected image with the color selected.

Replacing colors

- 1) Select an embedded image to start using the Color Replacer.
- 2) Go to **Tools > Color Replacer** on the Menu bar to open the Color Replacer dialog (Figure 164).
- 3) Click on **Pipette** at the top of the Color Replacer dialog to activate the color selection mode.
- 4) Move the cursor over the color to be replaced in the selected image and a preview of the color appears in the box next to **Pipette**.
- 5) Click on the color. The selected color appears in the first *Source color* preview box and a check mark appears next to it.
- 6) To select another color, place a check mark next to the second *Source color* preview box and click on another color in the selected image. A maximum of four colors can be selected in the Color Replacer dialog.
- 7) Enter the amount of tolerance required for replacing each selected color in the *Tolerance* boxes. The default selection is 10% tolerance.
- 8) In *Replace with*, select a color palette from the drop-down list, then select the required color from the color palette. **Transparent** is the default selection.
- 9) After selecting up to four colors for replacement, click **Replace** to replace the colors in the selected graphic. Examples of the original image and after image color replacement are shown in Figures 165 and 166.



Figure 165: Example image before replacing colors

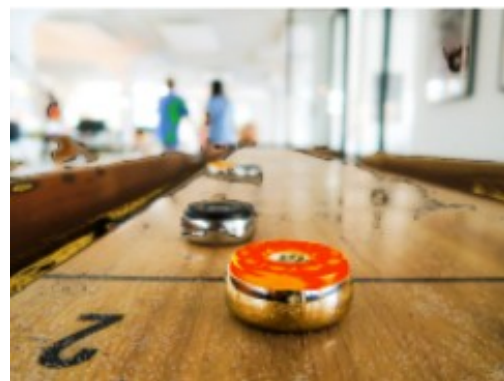

Figure 166: Example image after replacing colors

- 10) There is no preview of the effect. If the result is not satisfactory, select **Edit > Undo > Color Replacer** in the Menu bar and repeat the color replacement.

✓ Notes

Using the Color Replacer replaces all occurrences of the *Source color* that are in the selected image.

The default selection of *Transparent* in the *Replace with* boxes removes the selected color from the image and creates transparent areas in the selected image.

Replacing transparent areas

To replace any transparent areas in an image with a color use the following procedure:

- 1) Go to **Tools > Color Replacer** on the Menu bar to open the Color Replacer dialog.
- 2) Select an image with transparent areas.
- 3) Select **Transparency** in the Color Replacer dialog so that a check mark appears next to **Transparency**.
- 4) Select a color palette from the drop-down list next to **Transparency**, then select a color from the selected palette.
- 5) Click on **Replace** and the transparent areas are filled with the selected color.
- 6) There is no preview of the effect. If the result is incorrect, select **Edit > Undo > Image Color Replacer** in the Menu bar.

Conversion

Contour conversion

- Contour conversion converts a selected object to a polygon, or a group of polygons, with four corner points.
- Converting an image to a contour, the converted image is set as a background graphic.
- If the conversion creates a group of polygons (for example, contour conversion of a text object). Enter the polygon group before selecting an individual polygon within the group. For more information on working with groups, see Chapter 5, Combining Multiple Objects.
- After converting an image to a contour, the object can no longer be edited normally. The converted image has to be edited using **Edit > Points** on the Menu bar to adjust its shape. For more information on editing points, see Chapter 3, Working with Objects.

✓ Notes

Any editing to an object must be completed before carrying out a contour conversion because any further normal editing is not possible on the converted object.

No confirmation dialog is provided for a contour conversion.

- 1) Carry out all necessary editing on the object before converting to a contour.
- 2) Make sure the object is selected.

- 3) Convert the object to a contour using one of the following methods:
 - Go to **Shape > Convert > To Contour** on the Menu bar.
 - Right-click on the selected object and select **Convert > To Contour** from the context menu.

Polygon conversion

Polygon conversion is used to convert a selected image into a group of polygons filled with color. The image is also converted to a vector graphic and can be resized with no loss of image quality or distortion of any text. After conversion, the graphic can be broken into groups of polygons and then split into individual polygons. Breaking and splitting allows editing or deletion of individual colors within the graphic.

Conversion options and controls

Number of colors

Enter the number of colors to be displayed in the converted image. LibreOffice generates a polygon for each occurrence of a color in the image. The range for the number of colors is between 8 and 32.

Point reduction

Removes color polygons that are smaller than the pixel value entered. The range for point reduction is between 0 and 32 pixels.

Fill holes

Fills the blank areas in the graphic that can be created when applying a point reduction.

Tile size

Enter the size of the rectangle for the background fill. Tile sizes range between 8 and 128 pixels.

Source image

Preview of the original image.

Vectorized image

Preview of the converted image.

Preview

Creates a preview of the converted image in **Vectorized image** without applying any changes.

OK

Converts the image to a vector graphic consisting of polygons. The result is a metafile in SVM format (StarView Metafile) used by LibreOffice and allows transfer of the converted image to other LibreOffice documents.

Converting

- 1) Select an image in a drawing.
- 2) Convert the image into a polygon using one of the following methods and open the Convert to Polygon dialog (Figure 167).
 - Go to **Shape > Convert > To Polygon** on the Menu bar.
 - Right-click on the image and select **Convert > To Polygon** from the context menu.
- 3) Select **Number of colors** and **Point reduction** to be used in the conversion.
- 4) Select **Fill holes** to prevent any blank areas appearing in the converted image.

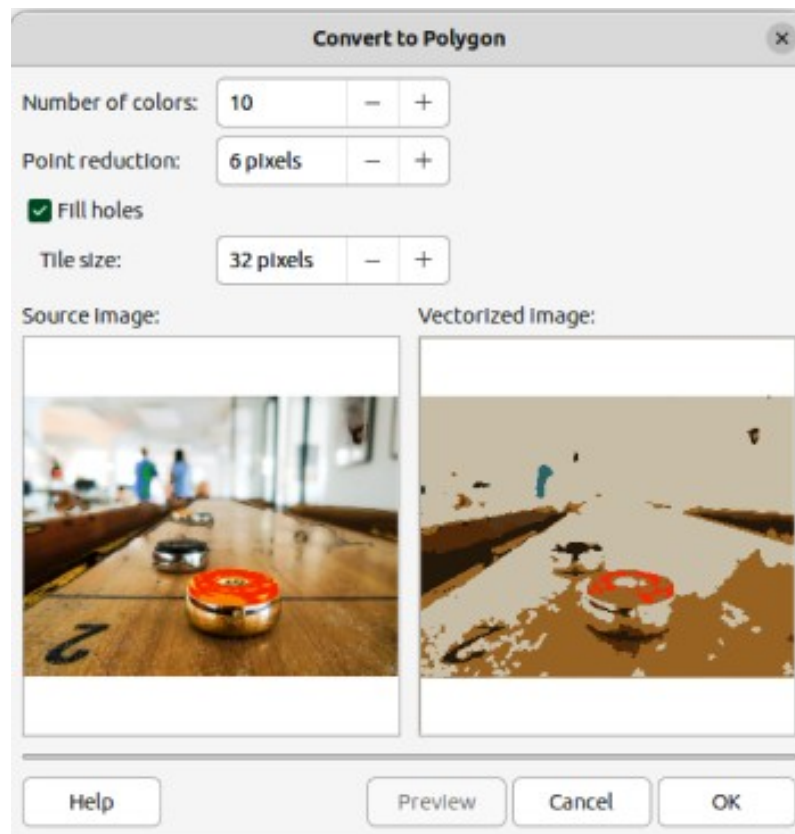

Figure 167: Convert to Polygon dialog

- 5) Enter the number of pixels to use for **Tile size**.
- 6) Click **Preview** to check how the converted graphic will look.
- 7) Make any necessary changes to the settings and check the preview again.
- 8) If the converted image meets the expected requirements, click **OK** to convert the image to a polygon and close the Convert to Polygon dialog.

Breaking

After converting an image to polygons, the vectorized image can be broken into groups of polygons. Each group of polygons consists of one color and becomes an object that can be used in another drawing.

- 1) Convert an image to polygons, see “Converting” above.
- 2) Make sure the converted image is selected, then use one of the following methods to break the image into groups of polygons:
 - Go to **Shape > Break** on the Menu bar.
 - Right-click on the image and select **Break** from the context menu.
- 3) Click on a color in the image and drag the group of polygons filled with that color out of the image to create a new image.
- 4) Alternatively, press *Delete* and delete the color from the image.

Splitting

After converting an image to polygons and breaking the image into polygon groups, these polygon groups can be split into individual polygons.

- 1) Convert an image to polygons, see “Converting” above.

- 2) Break the image into groups of polygons, see “Breaking” above.
- 3) Select the image, then use one of the following methods to split the polygon groups into individual polygons:
 - Go to **Shape > Split** on the Menu bar.
 - Right-click on the image and select **Shapes > Split** from the context menu.
 - Use the keyboard shortcut *Ctrl+Alt+Shift+K* (macOS *⌘+⌘+Shift+K*)
- 4) Select an individual polygon (or several polygons) in the image and drag the polygon from the image to create a new image in the drawing.
- 5) Alternatively, press *Delete* to delete the selected polygon(s) from the image.

Bitmap conversion

All drawing objects placed into a LibreOffice drawing are vector graphics and these vector graphics can be converted to a bitmap (raster graphic) in PNG format. Any transparency effects in the original vector graphic are lost during conversion even though the PNG format used by LibreOffice Draw supports transparencies. Use one of the following methods to convert a vector graphic to a bitmap. There is no confirmation dialog is provided for a bitmap conversion.

- Go to **Shape > Convert > To Bitmap** on the Menu bar.
- Right-click on the graphic and select **Convert > To Bitmap** from the context menu.



LibreOffice
Community



Draw Guide 7.5

Chapter 7

Working with 3D Objects

Introduction

Draw does not match the functionality of leading drawing or image editing programs, but it is capable of producing and editing 3D drawings. Using Draw, 3D scenes and extruded 3D shapes are created and edited. Depending on which 3D type is selected, there are different possibilities for further editing of the object (rotation, illumination, perspective, and so on). Extruded 3D shapes are simpler to set up and edit, but 3D scenes allow for greater customization.

3D object types

3D scenes

3D scenes are created from objects that use dimensions for x, y, and z coordinates and can contain object types, such as cube, sphere, extrusion object or rotation object. These object types do not exist outside a 3D scene.

The **Status Bar** indicates when a 3D scene is selected (Figure 168) created from a 2D object using body rotation or conversion. Alternatively, it is a ready-made 3D object that has been inserted into a drawing.

A 3D scene is similar to a group. Just like a group, a 3D scene is entered for editing an individual object in the 3D scene and exited after editing is completed. See Chapter 5, Combining Multiple Objects for more information on entering, editing and exiting groups.

When a 3D scene is created from a selection of several 2D objects, a group is automatically created as a single 3D scene. Enter this 3D scene so that individual objects within the 3D scene can be changed, edited and rotated.

Note

Individual objects cannot be ungrouped when a 3D scene has been created from a selection of 2D objects.

3D shapes

2D shapes are flat with only width and height dimensions, but 3D shapes are solid objects that have three dimensions of depth, width, and height.

A 3D shape is created when a 2D shape or an object from the Fontwork Gallery is converted into 3D using **Toggle Extrusion**. The **Status Bar** displays *Shape selected* when this type of 3D object is selected (Figure 169).

View 3D shapes are viewed and edited in 3D or 2D mode. To edit in 2D mode, switch off extrusion, make the editing changes, and switch back to 3D mode using **Toggle Extrusion**.

Note

Toggle Extrusion is only used when a 2D shape, or a 3D object that has been extruded from a 2D shape, or an object from the Fontwork Gallery is selected in a drawing. It is not available for text, lines, arrows, curves, and polygons.

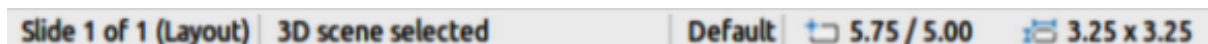



Slide 1 of 1 (Layout) | 3D scene selected | Default |  5.75 / 5.00 |  3.25 x 3.25

Figure 168: Status Bar — 3D scene selected



Slide 1 of 1 (Layout) | Shape selected | Default |  3.75 / 4.25 |  5.75 x 4.75

Figure 169: Status Bar — Shape selected

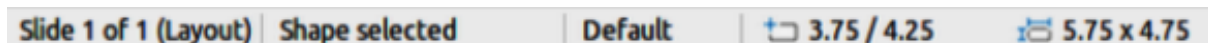
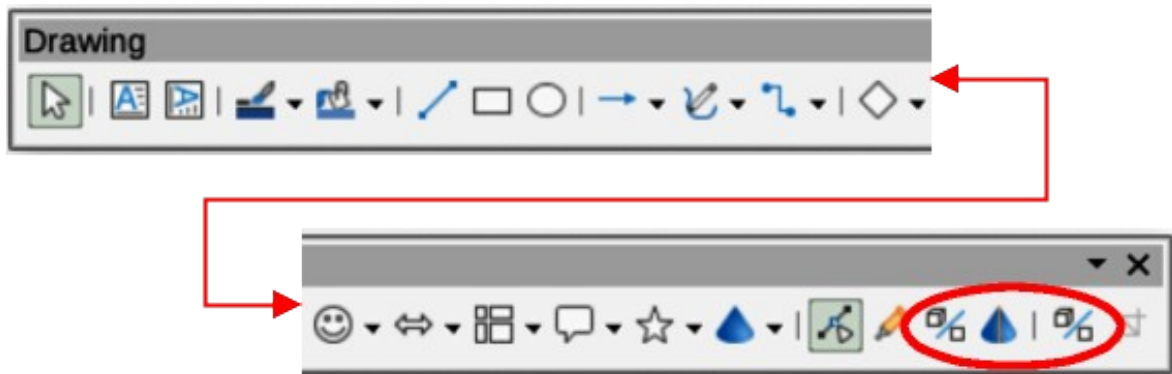

Figure 170: Drawing toolbar with 3D tools installed

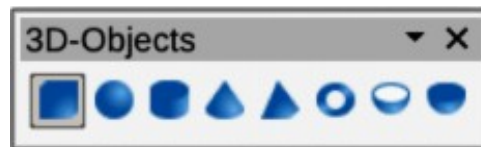

Figure 171: 3D-Objects toolbar

Creating 3D objects

3D ready made objects

3D ready made objects are 3D scenes inserted into a drawing using one of the following methods. The selection and drawing of 3D objects is the same for all methods of inserting a 3D ready made object.

- Click on the triangle ▼ to the right of **3D Objects** on the Drawing toolbar (Figure 170) and select a 3D object from the sub-toolbar that opens. The **3D Objects** icon displayed on the Drawing toolbar depends on the 3D object that has been previously selected and used.
- Go to **View > Toolbars > 3D-Objects** on the Menu bar to open the 3D-Objects toolbar (Figure 171). This toolbar has the same options available as the **3D Objects** sub-toolbar on the Drawing toolbar.
- Go to **Shapes > Insert > 3D Objects** on the Menu bar and select a 3D object from the submenu.
- Go to the **3D Objects** panel in the Shapes deck on the Sidebar (Figure 172) and select a 3D object.

✓ Note

Ready made 3D objects can be repositioned, resized, and edited in the same way as 2D objects. See Chapter 3, Working with Objects for more information.

Converting 2D objects

Convert a 2D object into a 3D object use one of the following tools. These tools are available on the Drawing toolbar (highlighted in Figure 170), by right-clicking on the object and selecting from the context menu, or the 3D Effects dialog:

- **To 3D** — creates a 3D scene containing an extrusion object.
- **To 3D Rotation Object** — creates a 3D scene using a default rotation axis.

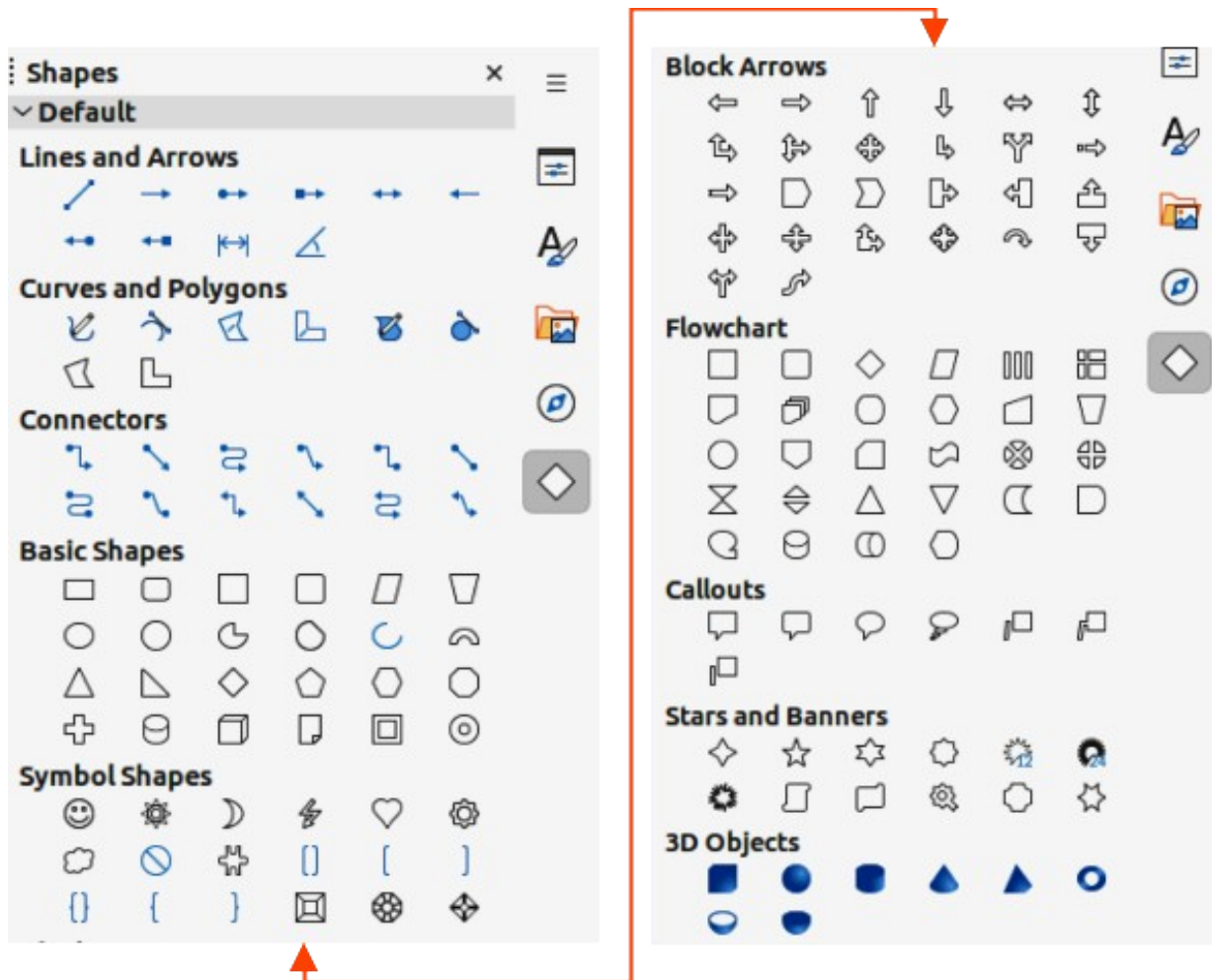

Figure 172: Shapes deck on Sidebar

- **Toggle Extrusion** — creates a 3D shape by extruding a 2D object into 3D. Only 3D shapes that have been extruded can be converted back to a 2D object.
- **Convert To Rotation Object** — available in the 3D Effects dialog. Converts a selected 2D object into a 3D rotation object. Also, selecting several ungrouped 2D objects can be converted into a single 3D rotation object. For more information see “3D effects” on page 170.

✓ Notes

Before creating 3D objects in a drawing, it is recommended that the extra 3D tools (**To 3D**; **To 3D Rotation Object**; **Toggle Extrusion**) are added to the Drawing toolbar using **Visible Buttons** or the Customize dialog. For more information on using **Visible Buttons** and the Customize dialog, see Appendix B, Toolbars and the *Getting Started Guide*.

After installing the 3D tools onto the Drawing toolbar, the tools only become available for use when a 2D object is selected in a drawing.

Extrusion

Extrusion converts a 2D object into a 3D scene by extruding a 2D object toward the observer. The scene is rotated by 20 degrees around the horizontal axis to make the 3D effect more visible. Examples of 3D conversion using extrusion are shown in Figure 173.



Figure 173: Example of 3D conversion using extrusion

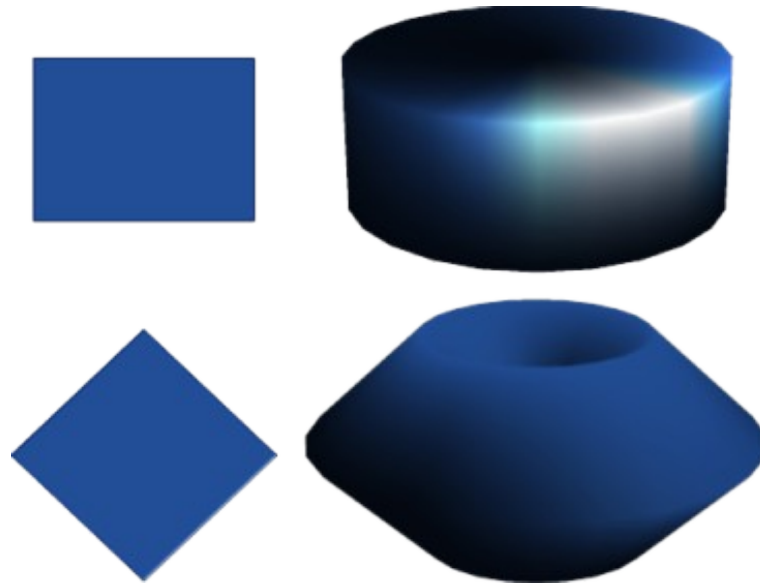

Figure 174: Example of 3D conversion using rotation

After selecting a 2D object, convert it to a 3D scene using one of the following methods:

- Right-click on the 2D object and select **Convert > To 3D** from the context menu.
- Click on **To 3D** in the Drawing toolbar.
- Go to **Shape > Convert > To 3D** on the Menu bar.
- Click on **Convert to 3D** in the 3D Effects dialog. For more information see “3D effects” on page 170.

Rotation

To 3D Rotation Object or **Convert to Rotation Object** converts a 2D object into a 3D scene by rotating the object using the left edge of the bounding box around the object as the axis of rotation. Examples of 3D conversion using either of these rotation tools are shown in Figure 174. The actual 3D scene created depends on the angle and shape of the object being rotated.

After selecting a 2D object in a drawing, convert it to a 3D scene using rotation with one of the following methods:

- Right-click on a 2D object and select **Convert > To 3D Rotation Object** from the context menu.
- Click on **To 3D Rotation Object** in the Drawing toolbar.



Figure 175: Example of 3D conversion using toggle extrusion

- Go to **Shape > Convert > To 3D Rotation Object** on the Menu bar.
- Click on **Convert To Rotation Object** in the 3D Effects dialog. For more information see “3D effects” on page 170.

Toggle extrusion

Extrusion is where parallel surfaces are moved to create a 3D shape. In Draw, the 2D surface is moved forwards out of the drawing level. At the same time the object is slightly tilted and central projection turned on, creating the impression of a 3D shape. Draw uses a default value for this extrusion (body depth) based on the size of the 2D object. The value can be changed after the extrusion, see “Editing 3D objects” on page 168.

Extrusion conversion is carried out using **Toggle Extrusion**. Extrusion only works on Basic Shapes, Symbol Shapes, Block Arrows, Flowcharts, Callouts, Stars and Banners, and Fontwork that are included as a part of the default set of tools on the Drawing toolbar, or in the Shapes deck on the Sidebar. Examples of toggle extrusion are shown in Figure 175.

- 1) Select a 2D object in a drawing created from Basic Shapes, Symbol Shapes, Block Arrows, Flowcharts, Callouts, Stars and Banners, or Fontwork.
- 2) Click on **Toggle Extrusion** on the Drawing toolbar to convert the 2D object into a 3D shape.
- 3) To convert a 3D conversion back into a 2D object, select the 3D object and click on **Toggle Extrusion** on the Drawing toolbar.

✓ Note

Extrusion cannot be used on text objects created using **Insert Text Box** or **Insert Vertical Text**.

Editing 3D objects

✓ Note

Where 3D scenes are created from more than one 2D object, a 3D scene group is automatically created. This 3D scene group cannot be ungrouped and any editing carried out affects all 3D objects within the group. To edit an individual 3D object within this 3D scene group, enter the group. For more information on working with groups, see Chapter 5, Combining Multiple Objects.

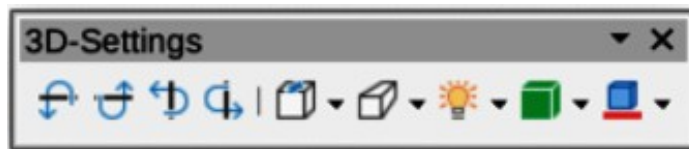

Figure 176: 3D-Settings toolbar

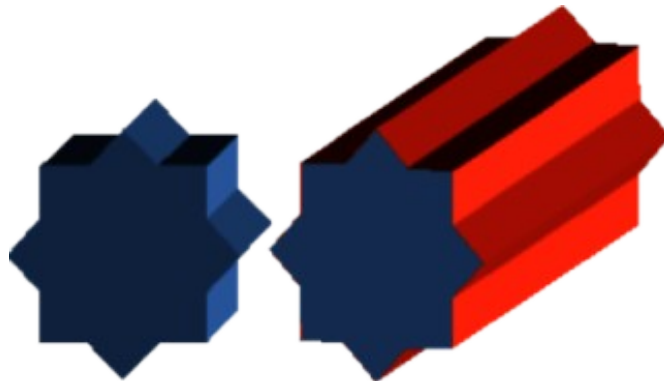

Figure 177: Example of changing 3D settings

Position, Size and Rotation

Editing the position, size and rotation of 3D objects is similar to 2D objects. See Chapter 3, Working with Objects for more information.

3D settings

Go to **View > Toolbars > 3D-Settings** on the Menu bar to open the 3D-Settings toolbar (Figure 176). The 3D-Settings toolbar activates when a 3D shape is selected created from a 2D object using “Toggle extrusion” on page 168.

Any changes made using the editing tools on the 3D-Settings toolbar are applied to the selected 3D shape immediately displaying the 3D effect. Figure 177 shows an example of tilting left, increasing extrusion depth, and changing 3D color using the 3D-Settings toolbar.

The tools available for editing 3D shapes are as follows.

Tilt Down

Tilts an object downward (horizontal axis rotation) by 5 degrees each time the tool is used.

Tilt Up

Tilts an object upward (horizontal axis rotation) by 5 degrees each time the tool is used.

Tilt Left

Tilts an object left (vertical axis rotation) by 5 degrees each time the tool is used.

Tilt Right

Tilts the selected object right (vertical axis rotation) by 5 degrees each time the tool is used.

Depth

Opens a pop-up menu where the extrusion depth can be set from an object by a fixed or custom amount.

Direction

Opens a pop-up menu where the view direction can be set to create an extrusion in either a perspective or parallel projection.

Lighting

Opens a pop-up menu where the direction and intensity of the lighting can be set when creating an extrusion.

Surface

Opens a pop-up menu where the surfaces of the object can be set as Wire Frame, Matt, Plastic, or Metal display.

3D Color

Opens a pop-up menu where the color used for the extrusion can be set. This color does not have to be the same as the color used for the original 2D object.

3D effects

The 3D Effects dialog (Figure 178) offers a wide range of possible settings for editing 3D ready made objects or 3D scenes. This dialog is also used to convert a 2D object to 3D using the tools in the bottom left corner of the dialog. Open the 3D Effects dialog using one of the following methods:

- Click on **3D Effects** on the Standard or Line and Filling toolbar.
- Go to **Format > 3D-Effects** on the Menu bar.

Any 3D effects applied to a 3D scene are not carried out until **Assign** is selected in the top right of the 3D Effects dialog. This allows for all 3D effect changes to be carried out before application to a 3D scene.

✓ Notes

The 3D Effects dialog cannot be used on 3D shapes created using **Toggle Extrusion** because the correct formatting results will not be achieved. If the 3D Effects dialog is used in error, remove any incorrect formatting by going to **Format > Default Formatting** on the Menu bar.

Any options grayed out in the pages in the 3D Effects dialog cannot be used for a selected object.

3D conversion

In the bottom left corner of the 3D Effects dialog are tools for converting a 2D object into a 3D scene and changing the projection used in a 3D scene.

Convert to 3D

Converts the selected object into a 3D scene. This tool works in the same way as using “Extrusion” on page 166.

Convert to Rotation Object

Converts a 2D object into a 3D scene using body rotation. This tool works in the same way as using “Rotation” on page 167.

Perspective On/Off

Switches perspective projection on or off for a 3D scene. Perspective projection is a technique to create a linear illusion of depth. As objects get further away from the viewer, a perspective drawing decreases in size at a constant rate.

✓ Note

The 3D Effects dialog has five pages to provide options for **Geometry, Shading, Illumination, Textures, and Material**. The tools to change pages for the different types of 3D effects are located at the top of the 3D Effects dialog.

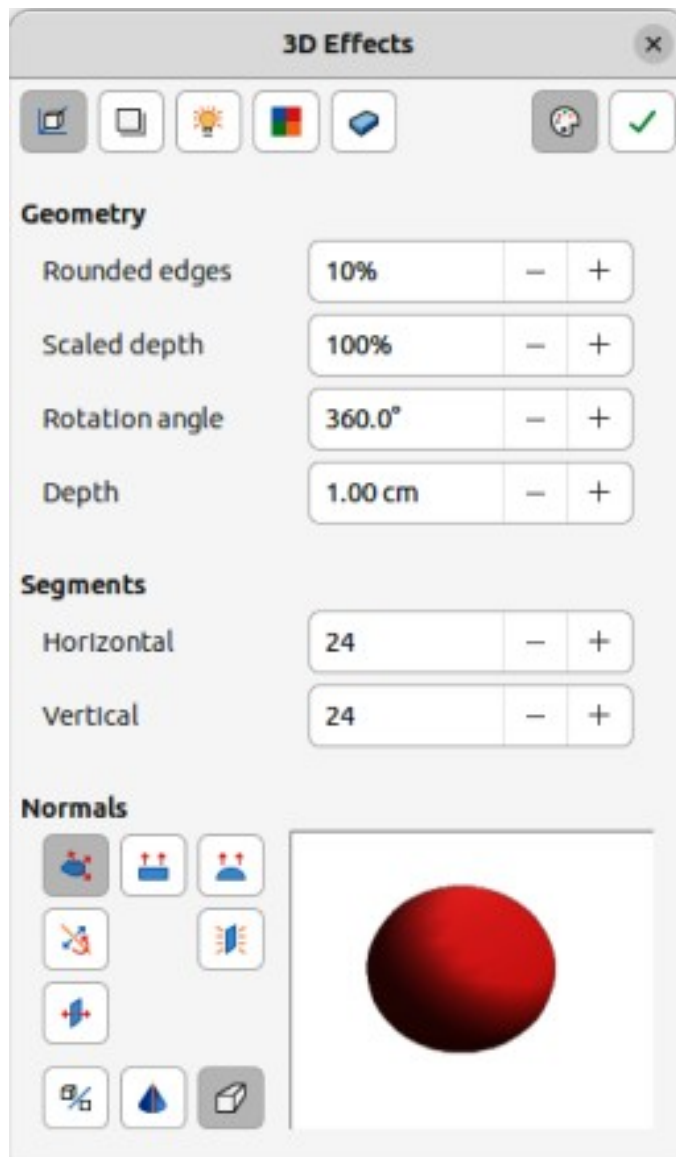

Figure 178: 3D Effects dialog — Geometry page

3D Effects — Geometry

Clicking on **Geometry** in the 3D Effects dialog (Figure 178) opens the options available on the Geometry page for changing the geometry of a 3D object.

Geometry

Defines the properties of an object in a 3D scene.

Rounded edges

Enter the amount required to round the corners of a 3D shape as shown by the example in Figure 179. The default setting for rounded edges is 10%.

Scaled depth

Enter the amount required to increase or decrease the frontal area of a selected 3D object. Figure 180 shows an example where the scaled depth has been increased to 150% and then decreased to 50%. The default setting for scaled depth is 100%.

Rotation angle

Enter the angle in degrees to rotate a 2D object that has been converted to 3D using To 3D Rotation Object. Figure 181 shows an example of a 2D circle where the rotation angle is changed to 180 degrees.

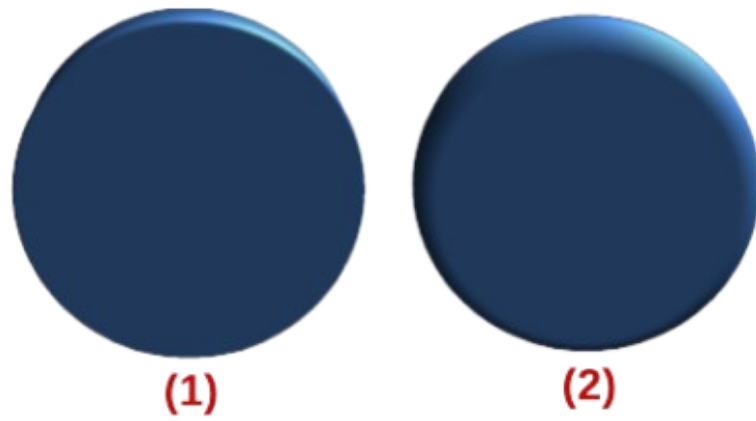

Figure 179: Example of rounded edges

- 1) 10% rounded edges (default)
- 2) 75% rounded edges

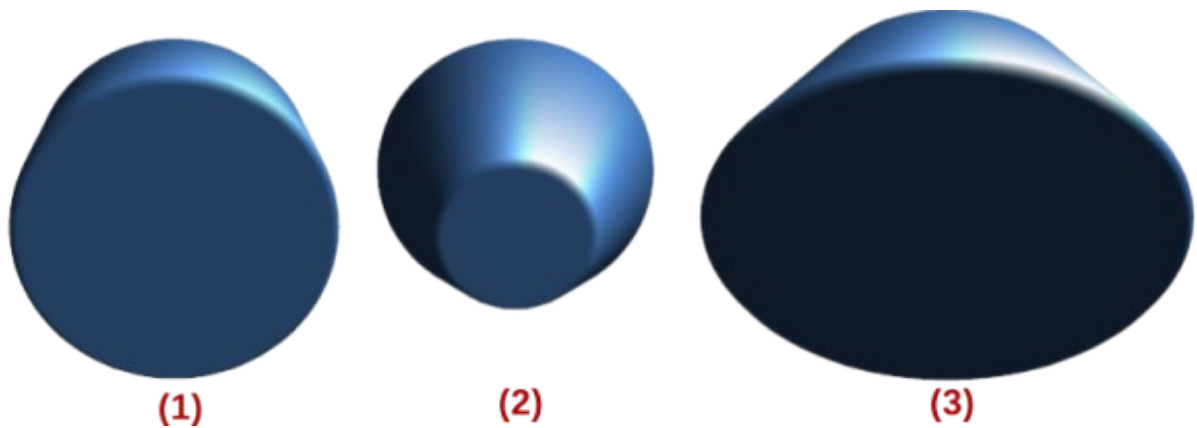

Figure 180: Example of changing scaled depth

- 1) 100% scaled depth (default)
- 2) 50% scaled depth
- 3) 150% scaled depth

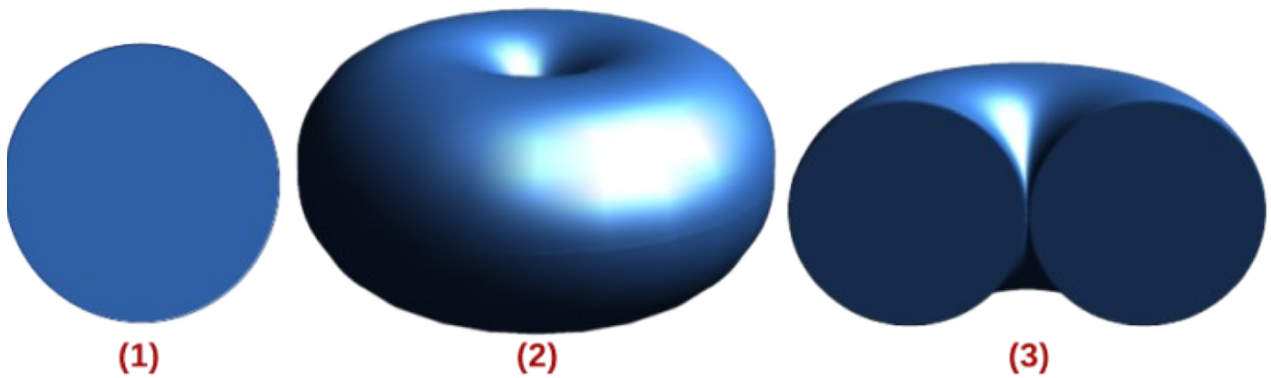

Figure 181: Example of changing rotation angle

- 1) 2D circle
- 2) Converted using To 3D Rotation Object
- 3) Rotation angle changed to 180 deg

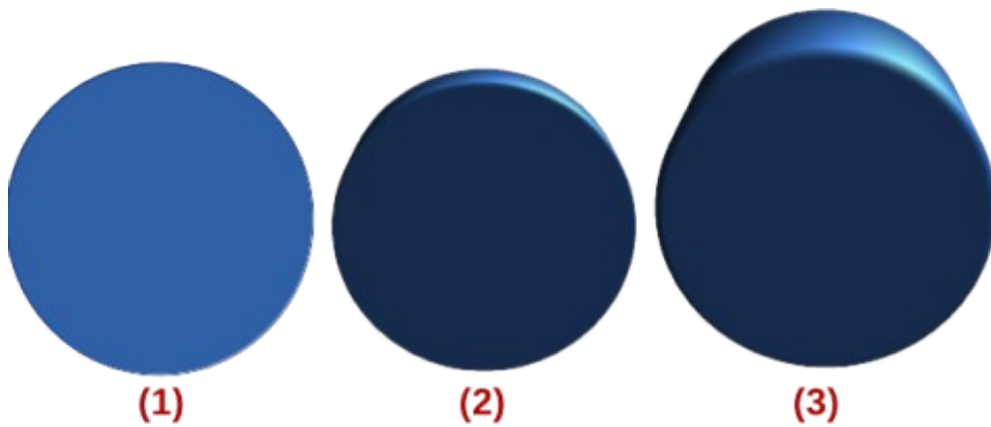

Figure 182: Example of increasing depth

- 1) 2D circle
- 2) Converted using To 3D
- 3) Depth increased to 3cm

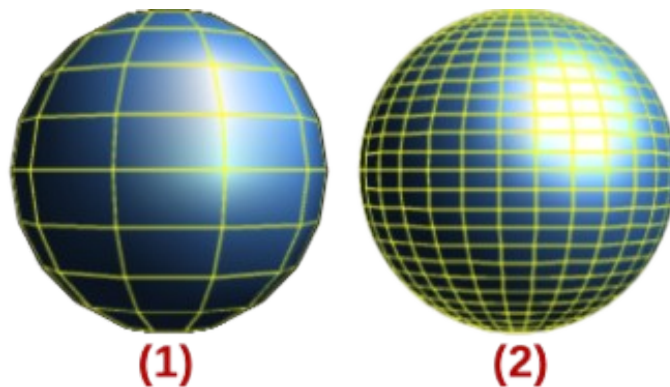

Figure 183: Example of using segments

- 1) 10 segments
- 2) 30 segments

Depth

Enter the extrusion depth for the selected 2D object that has been converted to 3D using To 3D. Figure 182 shows an example of a 2D circle converted to a 3D cylinder with the extrusion depth increased to 3 cm.

Segments

Changes the number of segments that Draw uses to draw a 3D rotation object. The higher the number of segments, the smoother the object surface is. However, a high segment number may increase the time it takes to generate the 3D object on a display. Figure 183 shows the difference on a 3D sphere when the segments have been increased from 10 to 30 segments horizontally and vertically.

Horizontal

Enter the number of horizontal segments used in the selected 3D rotation object.

Vertical

Enter the number of vertical segments used in the selected 3D rotation object.

Normals

Modifies the rendering style of the 3D surface.

Object-Specific

Renders the 3D surface according to the shape of the object. For example, a circular shape is rendered with a spherical surface (Figure 184).

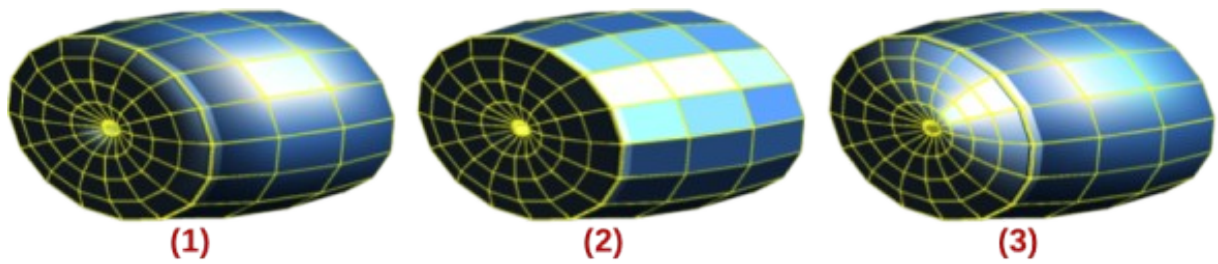

Figure 184: Examples of using object specific, flat and spherical effects

- 1) Object Specific
- 2) Flat
- 3) Spherical

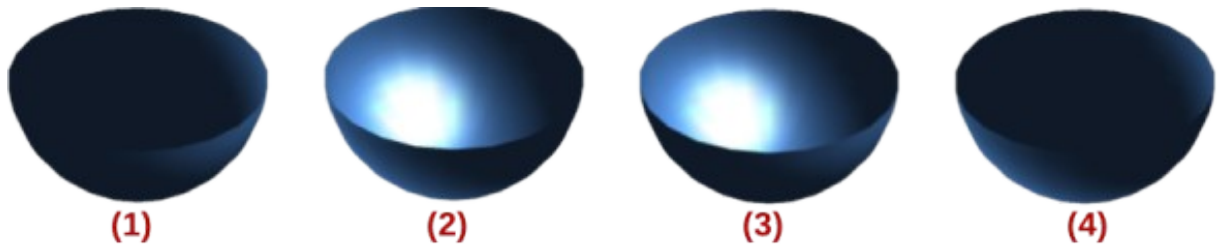

Figure 185: Examples of invert normals and double sided illumination

- 1) Invert Normals off; Double Sided Illumination off
- 2) Invert Normals on; Double Sided Illumination off
- 3) Invert Normals off; Double Sided Illumination on
- 4) Invert Normals on; Double Sided Illumination on

Flat

Renders the 3D surface as polygons (Figure 184).

Spherical

Renders a smooth 3D surface regardless of the shape of the object (Figure 184).

Invert Normals

Inverted normal is a normal that is pointing in the wrong direction (Figure 185). This tells a computer that an outside face is actually an inside face when it is not. If there is a hollow design, an inverted normal can be indicated because both surfaces facing are in and out in the same model.

Double-Sided Illumination

Lights the outside and the inside of the object (Figure 185). This has only an effect, if the inside is drawn at all, see *Double-Sided*. This is a setting for the whole of the 3D scene and not for a single object within the scene.

Double-Sided

3D object has outside (front) and inside (back) faces (Figure 185). With *Double-Sided* switched off, only the outside face of the object is rendered. The effect, when looking from outside, is that the object is solid, but, when looking from inside, the front face is transparent. If there is no view to the inside face, normal for an extruded 3D object with solid texture, *Double-Sided* should be switched off to improve performance during rendering. Any 3D object created using rotation often allows an inside view and it is recommended that *Double-Sided* is switched on.

✓ Note

Figure 185 demonstrates the 3D effect of using *Invert Normals* in conjunction with using the 3D effect *Double-Sided Illumination*.

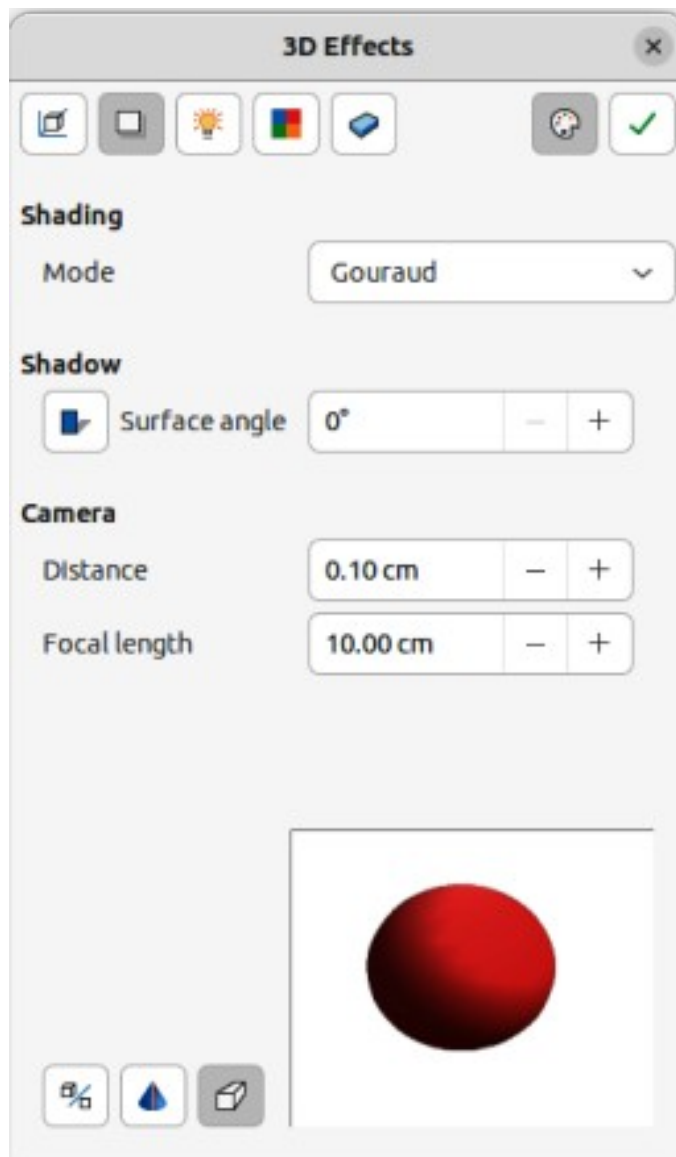

Figure 186: 3D-Effects dialog — Shading page

3D Effects — Shading

The **Shading** page of the 3D Effects dialog (Figure 186) provides options to set the shading, shadow, and camera effects on a selected 3D object.

Shading

Specifies the mode of shading applied to a 3D object (Figure 187).

Gouraud

This shading mode is a method used in computer graphics to simulate the differing effects of light and color across the surface of an object. In practice, it is used to achieve smooth lighting on low-polygon surfaces without the heavy computational requirements of calculating lighting for each pixel.

Phong

This shading mode is an interpolation technique for surface shading calculating the normal of a point in the polygon by interpolating the normals of the vertices. The angle between normal and lighting direction determines how much of the lighting is used to color the pixel.

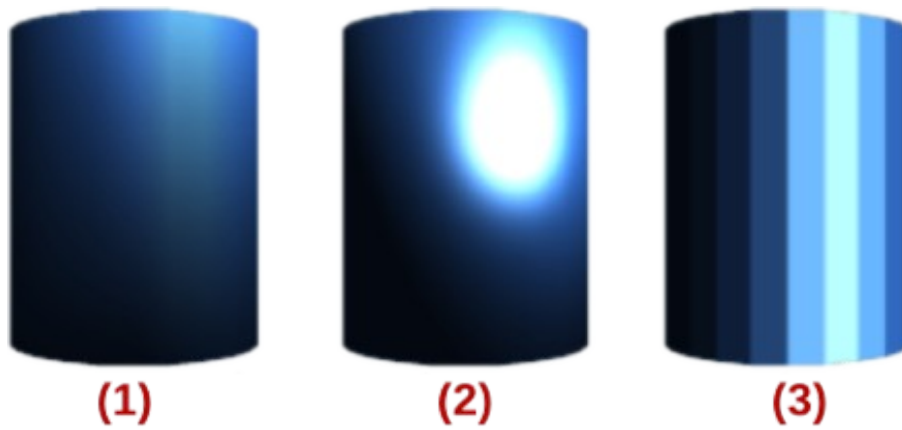

Figure 187: Examples of shading mode

- 1) Gouraud
- 2) Phong
- 3) Flat

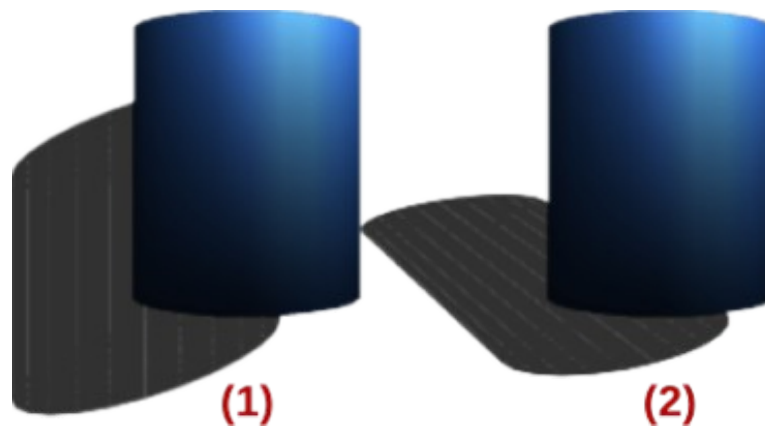

Figure 188: Examples of shadow surface angle

- 1) 0 deg shadow
- 2) 50 deg shadow

Flat

This shading mode refers to the depiction of depth perception in 3D models or illustrations by varying the level of darkness. It assigns a single color of shading to a single segment on the surface of the object.

Shadow

Adds or removes a shadow from a selected 3D object (Figure 188). A shadow is generated only from the first light source. Enter a *Surface Angle* from the light source to the surface between 0 to 90 degrees to cast a shadow.

Camera

Sets the camera options for a selected 3D scene as if a camera is being used to take a photograph (Figure 189). The settings affect only central perspective and not parallel projection.

Distance

Enter the distance to leave between the camera and the center of the selected 3D scene. The default setting for distance is 2.6cm.

Focal length

Enter the focal length of the camera lens, where a small value corresponds to a fisheye lens and a large value to a telephoto lens. The default setting for focal length is 10cm.

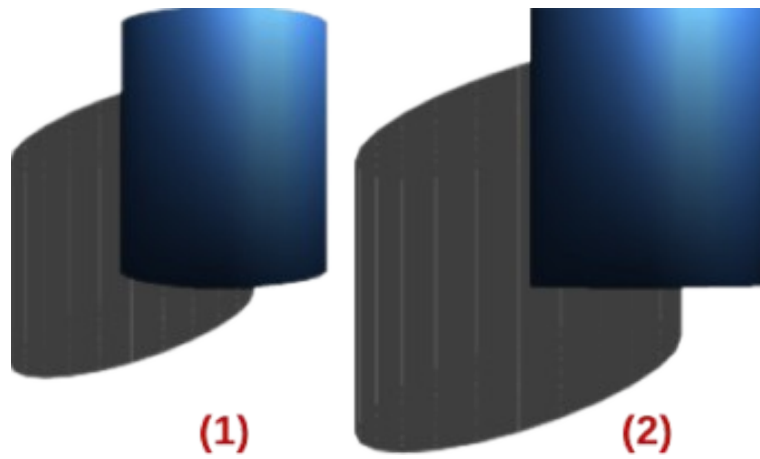

Figure 189: Example of changing camera angle

- 1) Default settings — distance 2.6 cm; focal length 10 cm
- 2) Distance 10 cm; focal length 100 cm

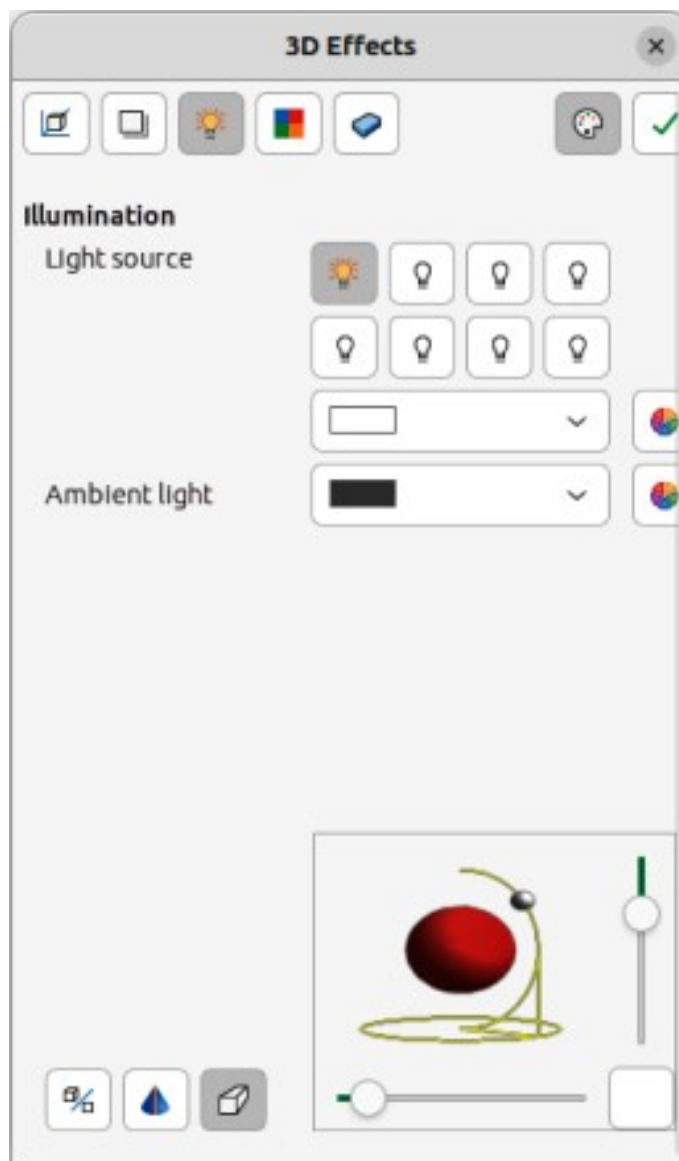

Figure 190: 3D Effects dialog — Illumination page

3D Effects — Illumination

The **Illumination** page of the 3D Effects dialog (Figure 190) defines how a 3D scene is lit and the settings apply to all 3D objects in a scene. The light source direction, color, and ambient light are specified for the 3D scene.

By default, one light source is already selected when the Illumination page is opened. A maximum of eight sources can be used and each light source can use a different color.

The light source location and color are shown in the lower right corner of the Illumination page. The vertical slider bar adjusts the lighting angle and the horizontal slider bar rotates the light about the object. Alternatively, click on the light point and drag the light source to the required position.

To change the preview from a sphere to a cube, click on the small square to the right of the horizontal slider bar and below the vertical slider bar.

Each light source selected is shown as a small colored sphere in the specified color. The larger colored sphere indicates the active light source.

- 1) Select a *Light* source to turn the light source on. The icon changes to an illuminated bulb.
- 2) Click again on the selected light source to adjust the color for the light source.
- 3) Select a color for the light from one of the color palettes in the *Light* source drop-down list. A different color can be used for each light source selected.
- 4) Select a color from one of the color palettes in the *Ambient* light drop-down list to set the color of the surrounding light.
- 5) To deselect a light source, select a light source already selected and click on it again.

3D Effects — Textures

On the **Textures** page of the 3D Effects dialog (Figure 191) the surface texture properties are set for a selected 3D object. **Textures** is only available after the area fill of a 3D object is set to *Gradient*, *Image*, *Pattern*, or *Hatch*. For more information on changing area fill, see Chapter 4, Changing Object Attributes.

Type

Sets the color properties of the texture.

Black & White

Converts the texture to black and white.

Color

Converts the texture to color.

Mode

Shows or hides shading.

Only Texture

Applies the texture without shading.

Texture and Shading

Applies the texture with shading to lighten or darken the illumination.

Projection X

Sets the options for displaying the texture along the X axis. Only one of the three following options can be selected.

Object-Specific

Automatically adjusts the texture for best fit based on the shape and size of the object. This is the default setting except for extrusion objects.

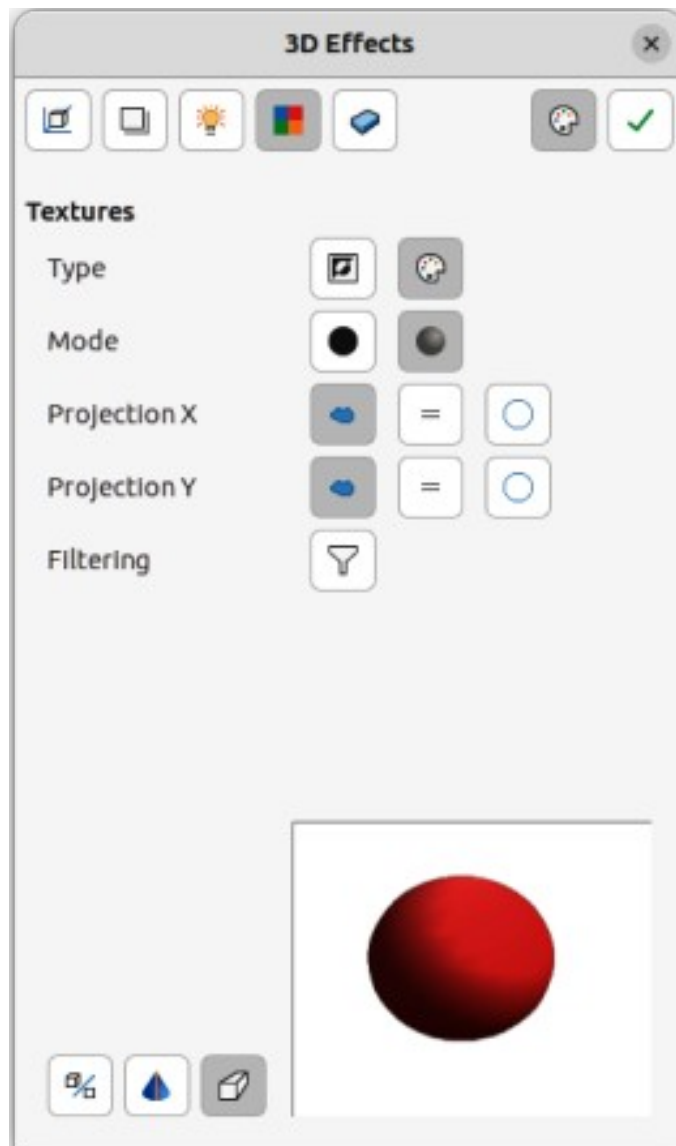

Figure 191: 3D Effects dialog — Textures page

Parallel

Applies the texture parallel to the horizontal axis and is mirrored on the rear side of the object. This is the default setting for extrusion objects.

Circular

Wraps the horizontal axis of the texture pattern around an object.

Projection Y

Sets the options for displaying the texture along the Y axis. Only one of the three following options can be selected.

Object-Specific

Automatically adjusts the texture for best fit based on the shape and size of the object. This is the default setting except for extrusion objects.

Parallel

Applies the texture parallel to the vertical axis and is mirrored on the rear side of the object. This is the default setting for extrusion objects.

Circular

Wraps the vertical axis of the texture pattern around an object.

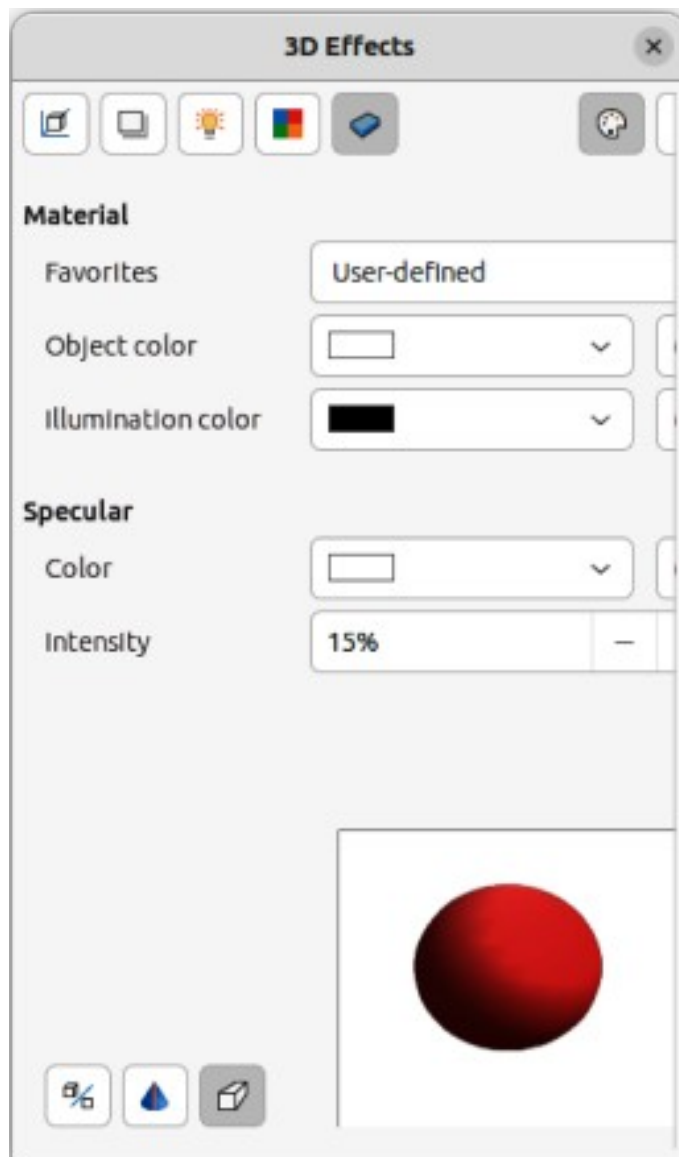

Figure 192: 3D Effects dialog — Material page

Filtering

Filters out noise that can occur when a texture is applied to a 3D object.

Filtering On/Off

Applies a soft focus filter blurring the texture slightly to remove unwanted speckles.

3D Effects — Material

On the **Materials** page of the 3D Effects dialog (Figure 192) the 3D object appearance is changed to represent different materials. **Materials** and **Textures** can be combined with each other and it is a matter of trial and error to achieve the desired result.

Material

Assigns a color from a color palette. For custom colors, see Chapter 11, Advanced Draw Techniques for more information on creating custom colors.

Favorites

Select a material type for the selected object from the *Favorites* drop-down list.

Object color

Select a color from one of the color palettes in the *Object color* drop-down list to apply to the object.

Illumination color

Select a color from one of the color palettes in the *Illumination* color drop-down list. This illuminates the object and brightens parts of the object which lie in shadow making the object seem more illuminated.

Specular

Sets the light reflection properties for the selected object simulating the reflecting capacity of the surface. The position of the illuminated point is determined by the setting of the first light source.

Color

Select a color to be reflected from the object from one of the color palettes in the *Color* drop-down list.

Intensity

Enter the intensity of the specular effect as a percentage.

Colors Dialog

Opens the Pick a Color dialog where custom colors are defined using the 2D graphic and numerical gradient chart. Any colors created are stored in the custom palette. See Chapter 11, Advanced Draw Techniques for more information on creating custom colors.

Note

Metallic and glass surfaces do not simulate well because the appearance of these materials is produced using reflection.

Tip

Do not use a very high brightness value for individual colors. Colors are additive and it is easy to end up with a colored area that is white.

Combining objects

Multiple 3D objects cannot be combined using **Shape > Combine** on the Menu bar or the keyboard shortcut *Ctrl+Shift+K* (macOS *⌘+Shift+K*). Multiple 2D objects have to be created first, then a single 3D object created as follows (see Chapter 5, Combining Multiple Objects for more information on combining objects):

- 1) Create multiple 2D objects and carry out all necessary editing changes.
- 2) Make sure all 2D objects are selected to create a single 3D object.
- 3) Create a single 3D object combining the selected 2D objects using one of the following methods (examples of 3D objects are shown in Figure 193):
 - Click on **To 3D** or **To 3D Rotation Object** on the Drawing toolbar.
 - Right-click on the selected multiple 2D objects and select **Convert > To 3D** or **To 3D Rotation Object** from the context menu.
 - Go to **Shape > Convert > To 3D** or **To 3D Rotation Object** on the Menu bar.

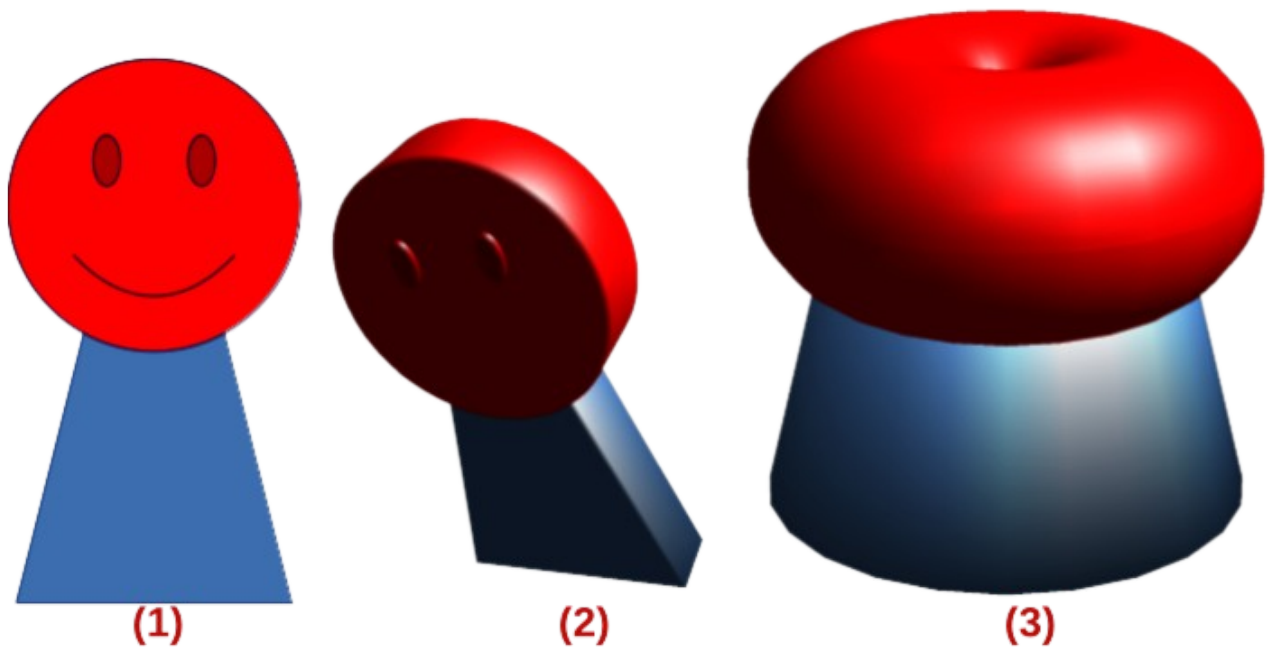

Figure 193: Example of creating a 3D object from multiple 2D objects

- 1) Multiple 2D objects
- 2) 3D object created using **To 3D**
- 3) 3D object created using **To 3D Rotation Object**

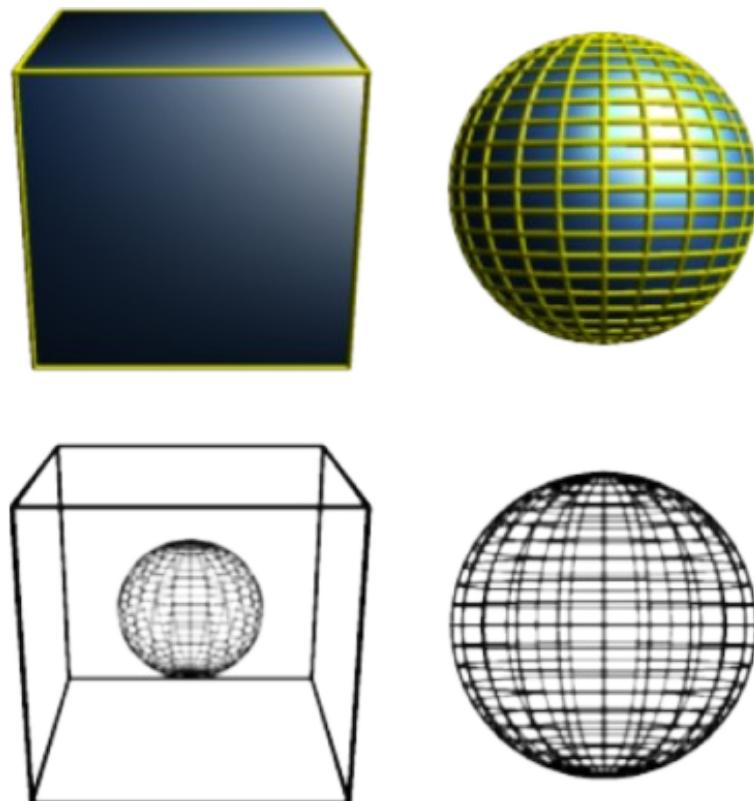

Figure 194: Example of assembling 3D objects

Assembling 3D objects

3D objects that each form a separate 3D scene can be combined or assembled into a single 3D scene. An example procedure for assembling 3D objects is as follows and shown in Figure 194:

- 1) Select a 3D object (for example, a cube) from **3D Objects** on the Drawing toolbar, or Shapes deck on the Sidebar and place it in a drawing.
- 2) Select a second 3D object (for example, a sphere) from **3D Objects** on the Drawing toolbar, or Shapes deck on the Sidebar and place it in the drawing.
- 3) If necessary, set the area fill to **None** and the lines to **Continuous** to create wire frame objects. This makes it easier to position both objects in the assembled 3D scene.
- 4) Select the second 3D object (sphere) and go to **Edit > Cut** on the Menu bar, or right-click on the object and select **Cut** from the context menu.
- 5) Double-click the first 3D object (cube) to enter the group, or go **Shape > Group > Enter Group** on the Menu bar.
- 6) Go to **Edit > Paste** on the Menu bar, or right-click on the first 3D object and select **Paste** from the context menu. The sphere now appears inside the cube and is now part of the same group.
- 7) If required, edit the individual objects, or change their position within the group.
- 8) Double-click outside the 3D assembled scene to exit the group, or go to **Shape > Group > Exit Group** on the Menu bar.

Note

The second object also reappears in its original position when **Paste** is carried out. This object is NOT part of the assembled 3D scene and can be deleted if necessary.



LibreOffice
Community



Draw Guide 7.5

Chapter 8, Connections, Flowcharts, and Organization Charts

Connectors and gluepoints

Connectors are lines or arrows whose ends automatically dock to a connection or gluepoint on the border of an object. Connectors use connecting lines between objects and these connecting lines remain connected to objects, even when objects are moved or rearranged. Also, when an object with a connector attached is moved or resized, the connector automatically adjusts its shape to accommodate the changes. For example, when creating a flowchart, or an organization chart, using connectors instead of simple lines removes the need to redraw lines between objects when making changes to a chart.

When a connector is drawn or selected, the selection handles are different to the normal selection handles used on lines or objects. The termination points of a connector are round at the start and end points of a connector, and square in the center of the lines that make up a connector, as shown by the example of a straight connector in Figure 195. The square selection handles on the selected connector are used to change the routing of a connector.

Connectors

Draw has a comprehensive selection of connectors, for example, when used in a flowchart or organization chart. The default set of connectors can be accessed using one of the following methods:

- Click the triangle ▼ to the right of **Connectors** on the Drawing toolbar to open a pop-up toolbar. The **Connectors** icon changes shape depending on the last connector used.
- Select a connector from the options available in the **Connectors** panel in the Shapes deck on the Sidebar.

Connectors sub-toolbar

If necessary, the connectors on the Drawing toolbar can be displayed as a Connectors sub-toolbar as follows:

- 1) Click on the triangle ▼ on the right of **Connectors** on the Drawing toolbar to open a pop-up toolbar.

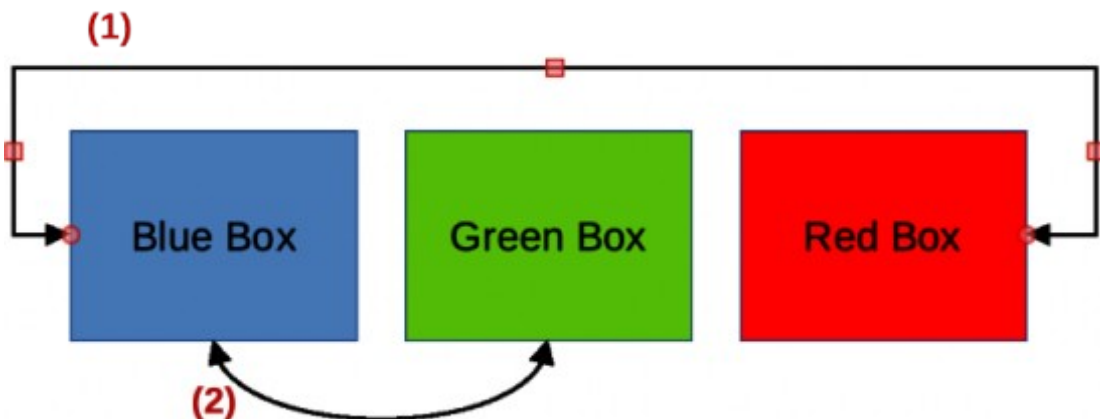

Figure 195: Example of connectors between objects

- 1) Straight connector with arrows
- 2) Curved connector with arrows



Figure 196: Connectors sub-toolbar

- 1) Click on the line at the top of the pop-up toolbar and drag it on to the Workspace.
- 2) Release the cursor to create the Connectors sub-toolbar (Figure 196).

Connector type groups

Connectors are grouped into four main groups as follows:

Standard

Standard connectors start with **Connector**. Line segments run vertically and horizontally. Creates a connector with one or more 90 degree angle bends.

Line

Line connectors start with **Line**. Consists of a line segment with two smaller segments at the ends and draws a connector that bends near a gluepoint. To adjust the length of the line segment between a bend point and a gluepoint, click on the connector and drag the bend point.

Straight

Straight connectors start with **Straight**. Consists of a single line and draws a straight line connector.

Curved

Curved connectors start with **Curved**. Based on Bézier curves, a curved connector is drawn and bends around objects.

Connector types

The full range of available connectors are accessed by clicking on the triangle ▼ on the right of the Connectors sub-toolbar and selecting **Visible Buttons** from the context menu. Depending on the computer system being used, connectors already installed on the Connectors sub-toolbar are indicated either by a check mark against the name, or the connector icon is highlighted.

Connectors are installed on the Connectors sub-toolbar in the same order that they appear in the **Visible Buttons** drop-down list. The connector types are numbered from left to right when installed on the Connectors sub-toolbar.

- | | |
|--|---|
| 1) Connector Ends with Arrow | 13) Connector Ends with Circle |
| 2) Straight Connector Ends with Arrow | 14) Straight Connector Ends with Circle |
| 3) Curved Connector Ends with Arrow | 15) Curved Connector Ends with Circle |
| 4) Line Connector Ends with Arrow | 16) Line Connector Ends with Circle |
| 5) Connector | 17) Connector Starts with Circle |
| 6) Straight Connector | 18) Straight Connector starts with Circle |
| 7) Curved Connector | 19) Curved Connector Starts with Circle |
| 8) Line Connector | 20) Line Connector Starts with Circle |
| 9) Connector Starts with Arrow | 21) Connector with Circles |
| 10) Straight Connector starts with Arrow | 22) Straight Connector with Circle |
| 11) Curved Connector Starts with Arrow | 23) Curved Connector with Circle |
| 12) Line Connector Starts Arrow | 24) Line Connector with Circle |

Adding connectors to objects

- 1) Click on the triangle ▼ on the right of Connectors on the Drawing toolbar to open the options available for selecting connectors.
- 2) Select the type of connector required and move the cursor onto the first object. When the cursor is over the first object, small crosses appear around the object edges replacing the object selection handles as shown in Figure 197.
- 3) Position the cursor over a gluepoint, then click and drag the cursor toward another object to start creating a connector. When the cursor reaches the target object, small crosses appear indicating gluepoints around the object edges, as shown in Figure 197.

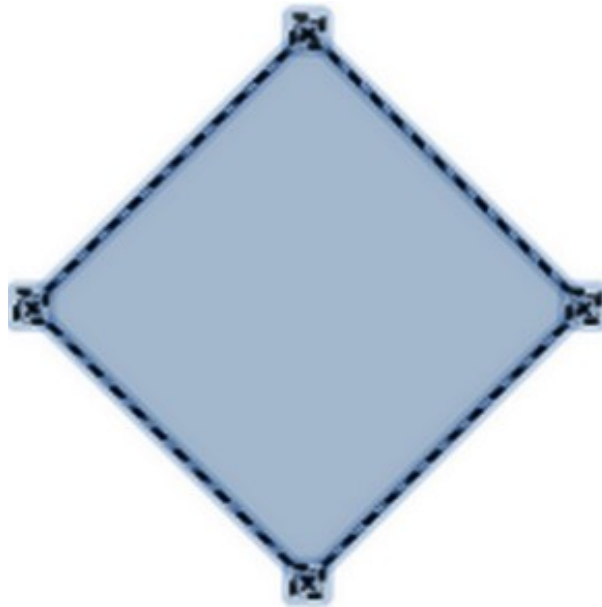

Figure 197: Example of object gluepoints

- 4) Move the cursor over the required gluepoint on the target object and release the connector to draw the connector. The round selection handles at each end of the connector are attached to the gluepoints on each object.
- 5) If necessary, use the square control points that appear on the connector to adjust the path of the connector so that it does not cover any other object in its path. See “Modifying connectors” on page 188 for more information.

✓ Notes

The start and end round selection handles of a connector cannot be swapped. To swap the start and end points of a connector, the connector has to be deleted and a new connector drawn in the opposite direction.

The end point of a connector can also be positioned in an empty part of a drawing where it is locked into place. This end point can then be moved and attached to an object when necessary.

Modifying connectors

Connectors can be modified using one of the following methods:

- To detach or reposition a connector, click and drag one of the round end points of a connector line to a different location.
- To change the connector route between objects so that the connector does not overlap any objects on the route, click on one of the square control points on the connector line and drag it to a new position.
- To modify a connector, right-click on the connector and select **Connector** from the context menu to open the Connector dialog (Figure 198). Use this dialog to change connector type and its properties.

The options available in the Connector dialog are as follows:

Type

Select the connector type group from the drop-down list. See “Connector type groups” on page 187 for more information.

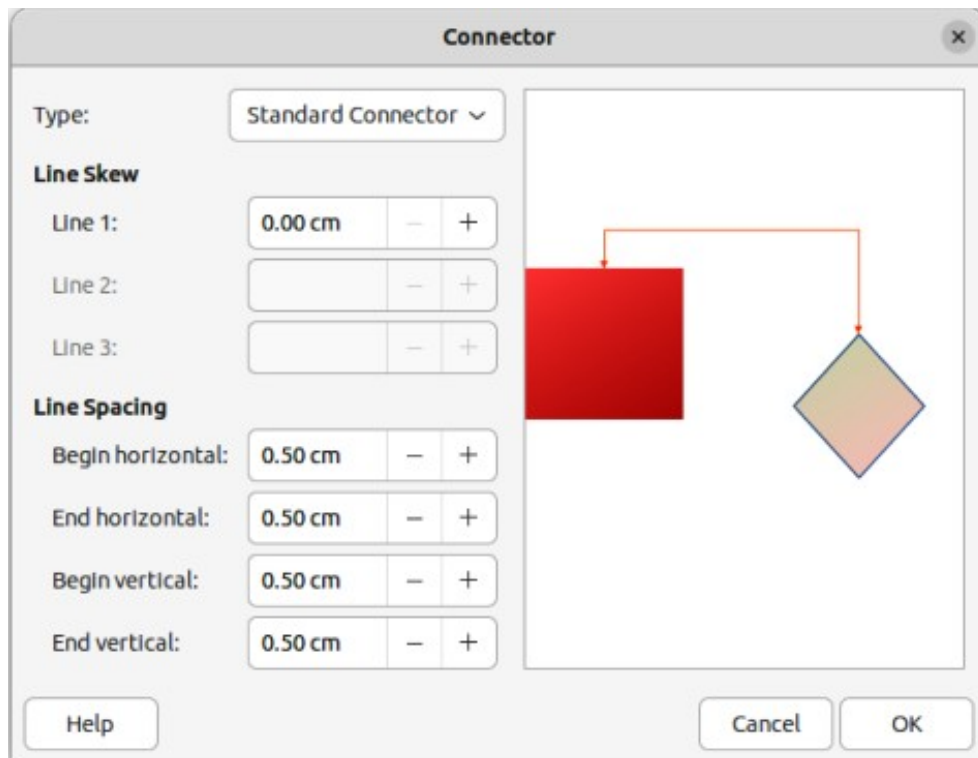

Figure 198: Connector dialog

Line skew

Defines the skew of a connector line. The dialog preview displays the result of any changes.

Line spacing

Sets the spacing around a connector.

Begin horizontal

Enter the amount of horizontal space required at the beginning of a connector.

End horizontal

Enter the amount of horizontal space required at the end of a connector.

Begin vertical

Enter the amount of vertical space required at the beginning of a connector.

End vertical

Enter the amount of vertical space required at the end of a connector

Preview box

Displays a preview of the selected connector and the objects the connector is connected to. The preview changes as changes to the selected connector are made using the Connector dialog. A left click zooms in on the preview and a right-click zooms out.

Gluepoints

Gluepoints are not the same as object selection handles. The selection handles are for moving or changing the shape of an object (see Chapter 3, Working with Objects for more information). Gluepoints are used to fix or glue a connector to an object so that when the object moves, the connector stays fixed to that object

All objects have gluepoints and Figure 197 on page 188 shows an example of the default gluepoints on an object. Gluepoints are not normally displayed on an object and only become visible when a connector is selected using one of the following methods.

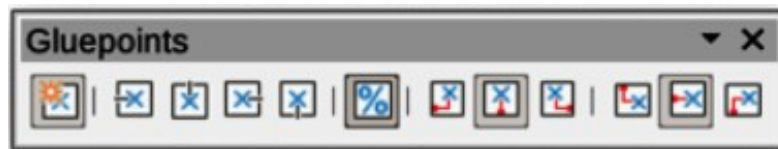

Figure 199: Gluepoints toolbar

- Select **Connectors** on the Drawing toolbar. The **Connectors** icon displayed on the Drawing toolbar is the connector type was previously used.
- A connector type is selected in the **Connectors** panel in the Shapes deck on the Sidebar.

To add, customize or delete gluepoints, go to **View > Toolbars > Gluepoints** on the Menu bar to activate the Gluepoints toolbar (Figure 199). This toolbar only becomes visible after using one of the following methods:

- Select **Show Gluepoint Functions** on the Drawing toolbar.
- Select **Edit > Gluepoints** on the Menu bar.

✓ Note

Show Gluepoint Functions on the Drawing toolbar is not part of the default set of tools for the Drawing toolbar. To add this tool, right-click in an empty area on the Drawing toolbar and select **Visible Buttons > Gluepoints** from the context menu.

Gluepoint types

When the Gluepoints toolbar opens, only the five tools on the left of **Gluepoint Relative** are active. The remaining six tools on the right of the toolbar only become active when **Gluepoint Relative** is deselected.

Insert Gluepoint

Inserts a gluepoint at the cursor position in an object when the button is clicked.

Exit Direction Left

Connector attaches to the left edge of the selected gluepoint.

Exit Direction Top

Connector attaches to the top edge of the selected gluepoint.

Exit Direction Right

Connector attaches to the right edge of the selected gluepoint.

Exit Direction Bottom

Connector attaches to the bottom edge of the selected gluepoint.

Gluepoint Relative

When selected, the gluepoint moves when an object is resized maintaining its position relative to the object borders. When deselected, a gluepoint can be repositioned after the object is resized. This tool is selected by default when the Gluepoint toolbar opens.

The following six tools only become active when **Gluepoint Relative** is deselected.

Gluepoint Horizontal Left

When an object is resized, the selected gluepoint remains fixed at the left edge of the object.

Gluepoint Horizontal Center

When an object is resized, the selected gluepoint remains fixed at the center of the object.

Gluepoint Horizontal Right

When an object is resized, the selected gluepoint remains fixed at the right edge of the object.

Gluepoint Vertical Top

When an object is resized, the selected gluepoint remains fixed at the top edge of the object.

Gluepoint Vertical Center

When an object is resized, the selected gluepoint remains fixed at the vertical center of the object.

Gluepoint Vertical Bottom

When an object is resized, the selected gluepoint remains fixed at the bottom edge of the object.

Note

Each gluepoint added to an object can have only one horizontal position and one vertical position. Only one of the horizontal position tools and one of the vertical position tools can be selected and used at any one time.

Adding gluepoints

By default, most objects normally have four gluepoints as shown in the example in Figure 197 on page 188. Additional gluepoints are added to an object as follows:

- 1) Go to **View > Toolbars > Gluepoints** on the Menu bar to activate the Gluepoints toolbar.
- 2) Make sure no objects are selected and use one of the following methods to open the Gluepoints toolbar:
 - Select **Show Gluepoint Functions** on the Drawing toolbar.
 - Select **Edit > Gluepoints** on the Menu bar.
- 3) Select the object, then click on **Insert Gluepoint** on the Gluepoints toolbar.
- 4) Move the cursor to the required position on the selected object and the cursor changes shape. Normally this is a cross, but the actual shape used depends on the computer setup.
- 5) Click once to add a gluepoint. To add more gluepoints, move the cursor to a new position and click.
- 6) When finished adding gluepoints, move the cursor off the selected object and click in an empty space to deselect the object.
- 7) Alternatively, right-click on a gluepoint previously added to the object and select **Insert Gluepoint** from the context menu, then click and drag the new gluepoint to the required position.
- 8) Select the type of gluepoint required from the options available on the Gluepoints toolbar. See “Gluepoint types” on page 190 for more information.

Note

When an object has no fill, a gluepoint can only be added to the border of an empty object.

Tip

When adding, moving or customizing gluepoints, it is recommended to use the zoom function making it easier to work with gluepoints. See Chapter 3, Working with Objects for more information. Also, gluepoints can snap to the grid making it easier to position a gluepoint.

Customizing gluepoint exit direction

Customize the exit direction for a gluepoint that has been added to an object as follows:

- 1) Go to **View > Toolbars > Gluepoints** on the Menu bar to activate and open the Gluepoints toolbar.
- 2) Double-click on a gluepoint that has been added to an object to select the gluepoint for customization.
- 3) Select the required exit direction for a connector attached to the gluepoint using one of the following methods:
 - Select the required exit direction on the Gluepoints toolbar.
 - Right-click on a gluepoint and select an exit direction from the context menu.

Customizing gluepoint positioning

Customize the horizontal and vertical positioning for a gluepoint that has been added to an object as follow:

- 1) Go to **View > Toolbars > Gluepoints** on the Menu bar to activate and open the Gluepoints toolbar.
- 2) Double-click on a gluepoint that has been added to an object to select the gluepoint for customization.
- 3) Click on **Gluepoint Relative** on the Gluepoints toolbar to deselect the tool, or right-click on the gluepoint and select **Gluepoint Relative** from the context menu to deselect the tool.
- 4) Select the horizontal and vertical positioning tools required for the gluepoint using one of the following methods. Only one horizontal positioning tool and one vertical positioning tool can be used at any one time:
 - Click and select the required horizontal or vertical positioning tool in the Gluepoints toolbar.
 - Right-click on the gluepoint and select the required horizontal and vertical positioning from the context menu.

Note

Only gluepoints that have been added to an object can be customized. The default gluepoints (example shown in Figure 197 on page 188) included with an object cannot be customized or deleted.

Deleting gluepoints

- 1) Select a gluepoint for deletion that has previously been added to the object.
- 2) Press the *Delete* or *Backspace* key, or go to **Edit > Cut** on the Menu bar.

Connector text

Text is easily added and formatted to connectors making a flowchart or organization chart easier to follow. See Chapter 9, Adding and Formatting Text for more information on working with and formatting text.

Adding text

- 1) Select a connector and the control points become active.
- 2) Enter text mode using one of the following methods. A flashing text cursor appears close to the connector and the Text Formatting toolbar (Figure 200) opens.
 - Click on **Insert Text Box** or **Insert Vertical Text** (if added) on the Drawing toolbar.
 - Use the keyboard shortcut *F2* to create horizontal text on the selected connector.
- 3) Type the required text for the connector.
- 4) If necessary, format the connector text. See “Formatting text” on page 193 for more information on formatting and editing text text.
- 5) When adding and formatting text is complete, move the cursor away from the text and connector, then click to end text mode. This also closes the Text Formatting toolbar.

✓ Note

In a default installation of LibreOffice, the **Insert Text Box** and **Insert Vertical Text** tools may not be installed on the Drawing toolbar. To add text tools to the Drawing toolbar, right-click in an empty area in the Drawing toolbar and go to **Visible Buttons**, then select **Text Box** and/or **Vertical Text** from the context menu.

Formatting text

- 1) Select a connector with text added and activate the control points to enter text mode. See “Adding text” on page 193 for more information on adding text to a connector.
- 2) Use the tools available on the Text Formatting toolbar, or the options available in **Format > Text** on the Menu bar to format the text. By default, connector text is formatted with horizontal central alignment and vertical central positioning for the connector text paragraph.
- 3) Right-click on the connector text and select **Text Attributes** from the context menu to open the Text dialog (Figure 202) and format the connector text as to how it appears next to the connector.
- 4) Click **OK** to save the changes to the text and close the Text dialog.
- 5) Move the cursor away from text and connector, then click to end the text mode. This also closes the Text Formatting toolbar.

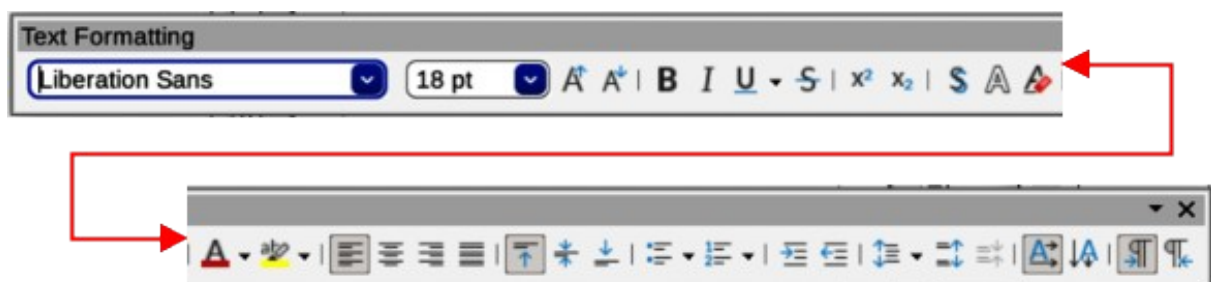

Figure 200: Text Formatting toolbar

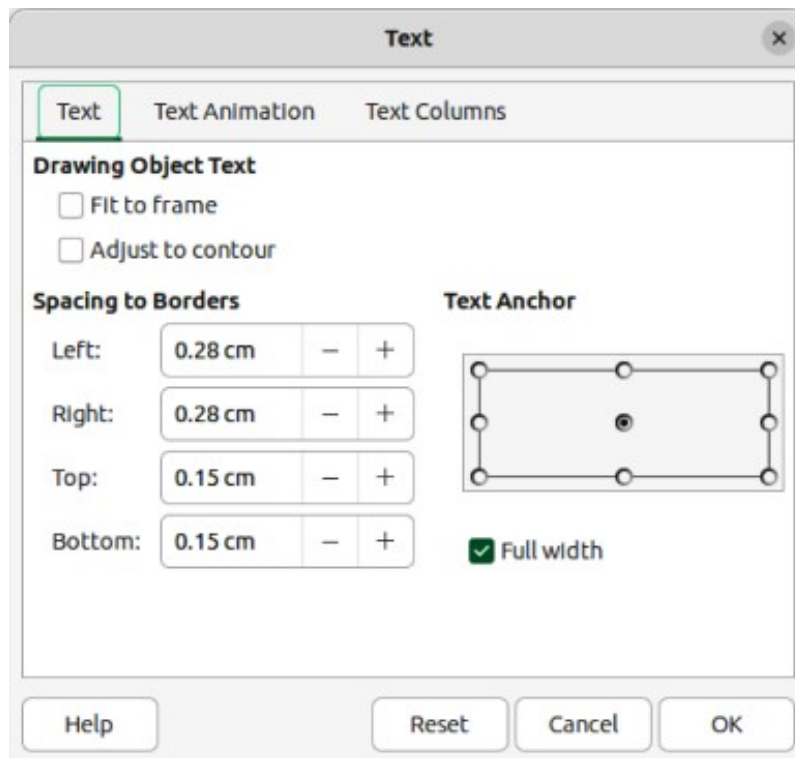

Figure 201: Text dialog — Text page

The options available in the Text dialog are as follows:

Drawing Object Text

Fit to frame

Resizes the text to fit the entire area of a connector rectangle or frame.

Adjust to contour

Adapts the text flow so that it matches the contours of the selected connector.

Spacing to Borders

Specify the amount of space to leave between the connector and the borders of the text.

Text Anchor

Select one of nine positions to anchor the text within the connector rectangle.

Full width

Anchors the text to the full width of the connector rectangle. When selected, only the top, middle and bottom center positions can be used to anchor the text

✓ Notes

The options available for text animation are not recommended for connector text unless the drawing is going to be displayed as part of a presentation. See the *Impress Guide* for more information on text animation.

The options available for text columns are not recommended for connector text. Text columns are normally used for text that is placed into a text box when adding information to a drawing, or into an object such as a rectangle or circle. For more information on text columns, see Chapter 9, Adding and Formatting Text.



Figure 202: Flowchart sub-toolbar

Flowcharts

Draw has a floating Flowchart sub-toolbar (Figure 203) that includes a large selection of flowchart tools to create a flowchart (also known as flow diagrams). The available flowchart shapes on the Flowchart sub-toolbar, from left to right, are as follows:

- | | |
|-----------------------------------|--------------------------------------|
| 1) Flowchart: Process | 15) Flowchart: Card |
| 2) Flowchart: Alternate Process | 16) Flowchart: Punched Type |
| 3) Flowchart: Decision | 17) Flowchart: Summing Junction |
| 4) Flowchart: Data | 18) Flowchart: Or |
| 5) Flowchart: Predefined Process | 19) Flowchart: Collate |
| 6) Flowchart: Internal Storage | 20) Flowchart: Sort |
| 7) Flowchart: Document | 21) Flowchart: Extract |
| 8) Flowchart: Multidocument | 22) Flowchart: Merge |
| 9) Flowchart: Terminator | 23) Flowchart: Stored Data |
| 10) Flowchart: Preparation | 24) Flowchart: Delay |
| 11) Flowchart: Manual Input | 25) Flowchart: Sequential Access |
| 12) Flowchart: Manual Operation | 26) Flowchart: Magnetic Disc |
| 13) Flowchart: Connector | 27) Flowchart: Direct Access Storage |
| 14) Flowchart: Off-page Connector | 28) Flowchart: Display |

If necessary, create a Flowchart sub-toolbar as follows:

- 1) Click on the triangle ▼ to the right of **Flowchart** on the Drawing toolbar to open a Flowchart pop-up menu.
- 2) Click on the line at the top of the **Flowchart** pop-up menu and drag the pop-up menu into the Workspace.
- 3) Release the cursor and the pop-up menu becomes a floating Flowchart sub-toolbar (Figure 203).

An example flowchart is shown in Figure 204 and the recommended basic steps when creating a flowchart are as follows:

- When adding objects or flowchart shapes to a flowchart, see Chapter 2, Drawing Basic Shapes for information on how to draw and resize object shapes.
- Add text to each flowchart shape to make it easily identified in the flowchart. See Chapter 2, Drawing Basic Shapes and Chapter 11, Advanced Draw Techniques for more information.
- Use connector lines in a flowchart. This allows repositioning of an object in a flowchart while maintaining connections with the other objects in the flowchart. See “Who is this user guide for?” on page 8 for more information.
- Use the zoom, grid, and snap functions to help in positioning objects in a flowchart. See Chapter 3, Working with Objects and Object Points for more information.
- Use the alignment and distribution functions to give a flowchart a more professional look. See Chapter 5, Combining Multiple Objects for more information.

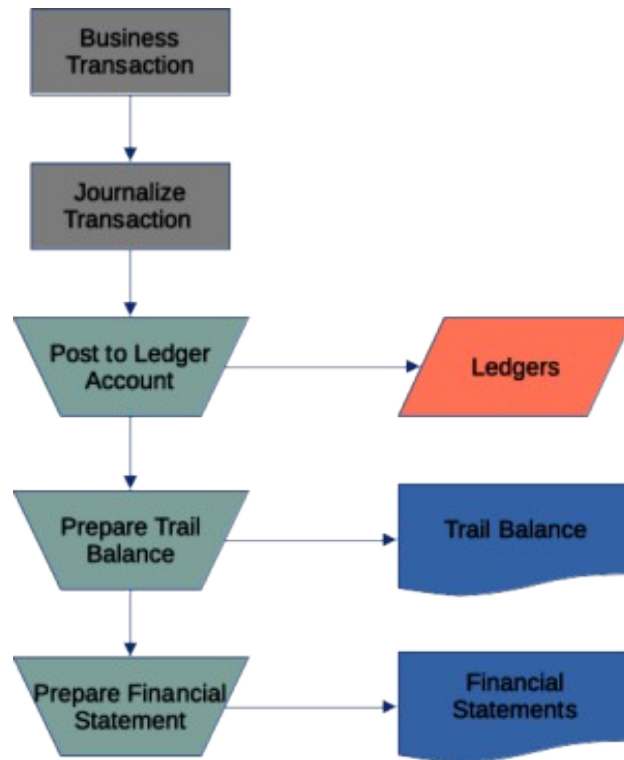

Figure 203: Example flowchart

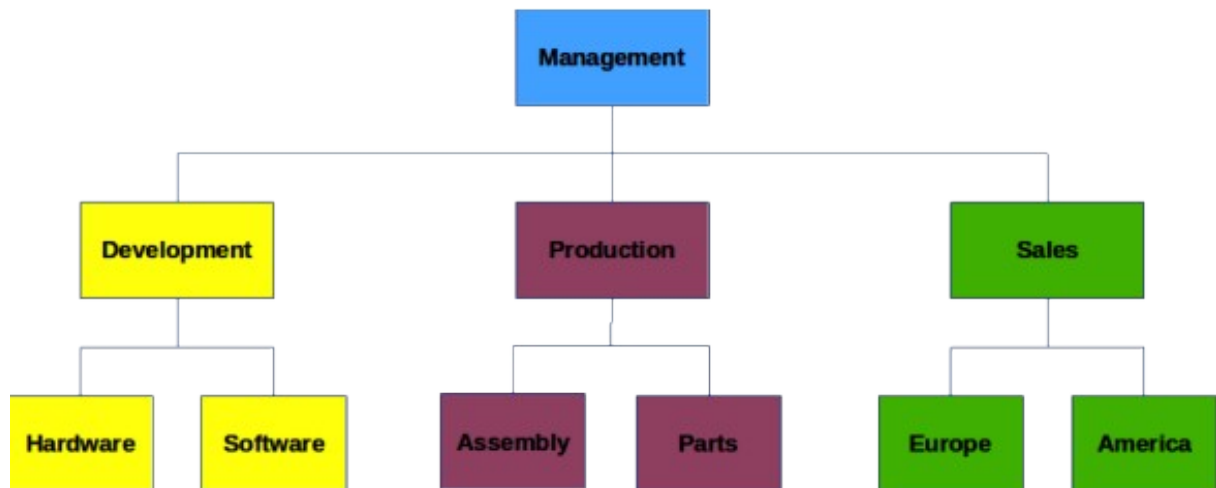

Figure 204: Example organization chart

Organization charts

Draw does not have a toolbar for organization charts, but these charts are easily created using basic shapes, flowchart shapes, and connectors. Hierarchy in an organization is easily indicated using shading and/or color. When using shading and color in an organization chart, make sure the selection provides a good contrast between the text and the shading or color. This makes the chart easy to read on a computer display or in a printed document.

An example of an organization chart is shown in Figure 204. This was drawn using the rectangle basic shape and connectors.

- When adding objects to a chart, see Chapter 2, Drawing Basic Shapes for information on how to draw and resize object shapes.

- Add text to each object in the organization chart to make it easily identified in the chart. See Chapter 2, Drawing Basic Shapes and Chapter 11, Advanced Draw Techniques for more information.
- Use connectors in an organization chart. This allows repositioning of an object in a chart while maintaining connections with the other objects in the chart. See “Connectors and gluepoints” on page 186 for more information.
- Use the zoom, grid, and snap functions to help in positioning objects in a chart. See Chapter 3, Working with Objects and Object Points for more information.
- Use the alignment and distribution functions to give an organization chart a more professional look. See Chapter 5, Combining Multiple Objects for more information.
- Duplicate objects when more than one of the same shape and size is required. See Chapter 5, Combining Multiple Objects for more information.



LibreOffice
Community



Draw Guide 7.5

Chapter 9, Adding and Formatting Text

Introduction

When text is used in drawings, it is placed inside an object or text box. This chapter describes how to create, format, use, delete text, and provides information for the various types of text that can be inserted into a drawing. Also, there is information on how to insert special forms of text such as numbered or bulleted lists, tables, fields, hyperlinks, columns, and Fontwork.

✓ Note

When selecting a text tool to add text to a drawing, Draw automatically switches to text mode. Also, the Text Formatting toolbar (Figure 205) automatically opens replacing the Line and Filling toolbar at the top of the drawing.

Text mode

Activating text mode

Before any text is typed into a drawing, text mode must be activated using one of the following methods.

- For horizontal text only, go to **Insert > Text Box** on the Menu bar.
- For horizontal text only, use the keyboard shortcut *F2*.
- Click on **Insert Text Box** for horizontal text, or **Insert Vertical Text** for vertical text on the Drawing toolbar (Figure 206), or Text toolbar (Figure 207).

Adding vertical text

If **Insert Vertical Text** is not visible on the Drawing toolbar, it can be added to the toolbar as follows:

- 1) Go to **Tools > Options > Language Settings > Languages** (macOS **LibreOffice > Preferences > Language Settings > Languages**) on the Menu bar to open the **Languages** page in the Options dialog.
- 2) In **Default Languages for Documents**, select the option *Asian*. Accept the default settings for this option.
- 3) Click **OK** to close the Options dialog and save the changes.
- 4) Right-click in an empty area on the Drawing toolbar (Figure 206) and select **Visible Buttons** from the context menu.
- 5) Select **Vertical Text** from the drop-down list of options to add **Insert Vertical Text** to the Drawing toolbar.

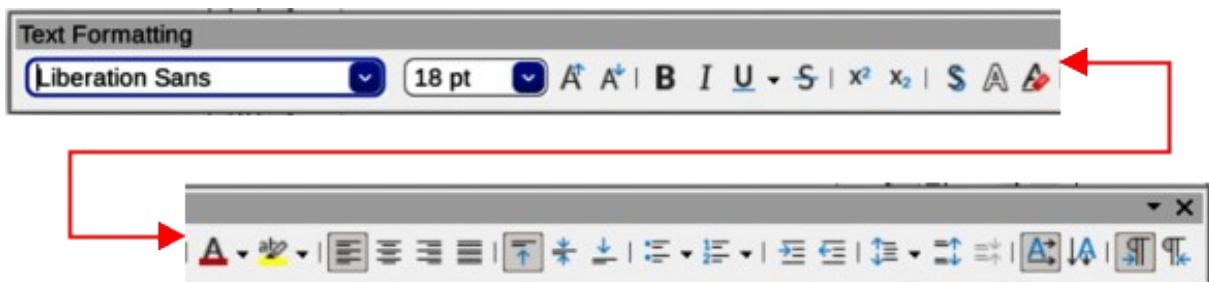

Figure 205: Text Formatting toolbar

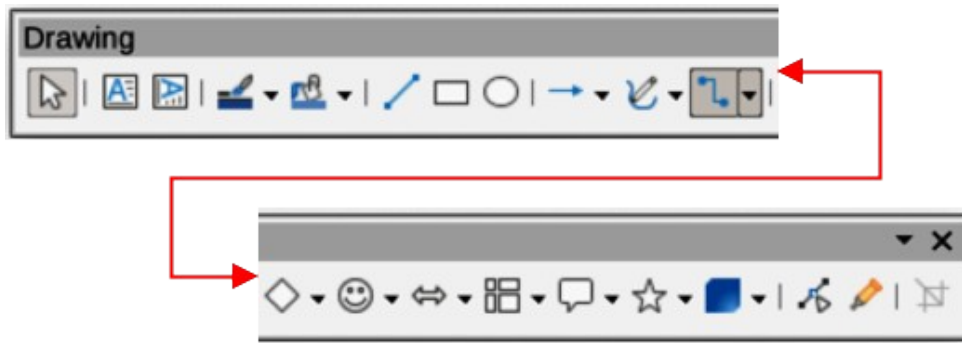

Figure 206: Drawing toolbar

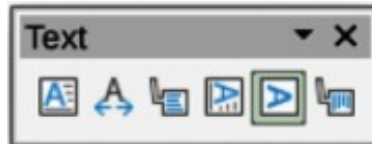

Figure 207: Text toolbar

Text toolbar

It is recommended to have the Text toolbar (Figure 207) available in Draw when working text. If the Text toolbar is not available, go to **View > Toolbars** on the Menu bar and select **Text** from the context menu to add it to the available toolbars. The tools available on the Text toolbar, numbered from left to right, are as follows:

- | | |
|----------------------------------|-------------------------------|
| 1) Insert Text Box (<i>F2</i>) | 4) Insert Vertical Text |
| 2) Fit Text in Textbox Size | 5) Fit Vertical Text to Frame |
| 3) Callouts | 6) Vertical Callouts |

Text boxes

Creating text boxes

When text is added to a drawing, a text box is automatically created to contain the text. By default, the text box either expands horizontally to accommodate a single line of horizontal text, or vertically to accommodate a single line of vertical text.

✓ Note

Text boxes are only for text and cannot contain illustrations, inline pictures, formulas, tables, or objects.

- 1) Activate text mode in Draw for horizontal or vertical, see “Activating text mode” on page 200. The Text Formatting toolbar automatically opens, replacing the Line and Filling toolbar.
- 2) Click at the approximate position in the drawing to insert the text box. A text box is created containing a flashing text cursor for the operating system and computer setup being used.
- 3) Type or paste the text into the text box and the text box expands either horizontally or vertically to accommodate a single line of text. Also, the left corner of the Status Bar indicates text edit mode and the position of the text cursor (Figure 208).
- 4) To create multiple lines in the text box, use one of the following methods:
 - Press the *Enter* key at the end of a line of text to create single line paragraphs inside the text box. The text box expands to accommodate more lines of text.

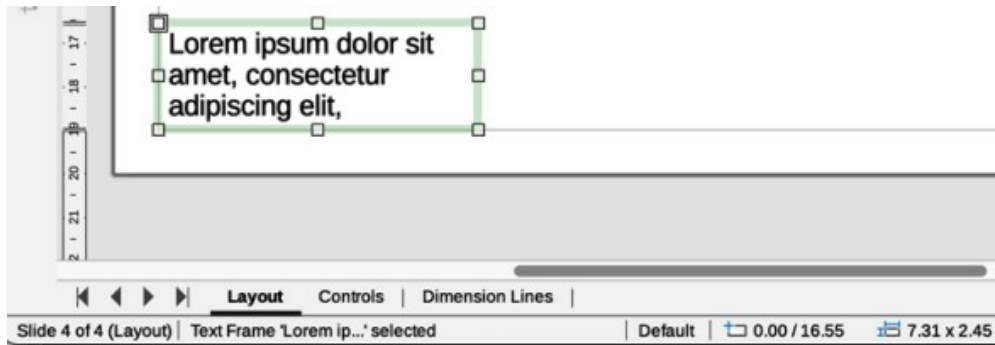

Figure 208: Example of text information on the Status Bar

- For horizontal text, click and drag the text cursor horizontally creating a text box with the approximate width required. As the limits of the text box are reached, the text automatically word wraps inside the text box and increases text box height as more text lines are added.
 - For vertical text, click and drag the text cursor vertically creating a text box with the approximate height required. As the limits of the text box are reached, the text automatically word wraps inside the text box and increases text box width as more text lines are added.
- 5) Move, resize, rotate or format the text box as required. For more information, see the following sections and Chapter 3, Working with Objects.
 - 6) Format the text using the various tools on the Text Formatting toolbar. For more information on text formatting, see “Formatting text” on page 211.
 - 7) When adding and formatting text is completed, click outside the text box to save the changes and deselect the text box.

Text box borders

By default, when a text box is created, the borders of the text box are only displayed when the text box is selected. If necessary, use one of the following methods to create a visible border around the text box.

Line and Filling toolbar

- 1) If the Line and Filling toolbar is not visible, go to **View > Toolbars > Line and Filling** on the Menu bar to open the toolbar.
- 2) Click on a text box to select it and display the border indicating that the text box is in edit mode.
- 3) In **Line Style** on the Line and Filling toolbar (Figure 209), select a line style from the options in the drop-down list.

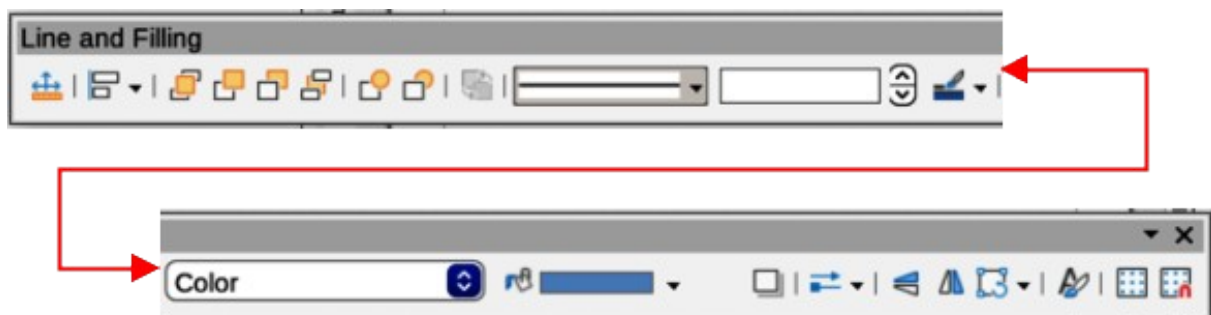

Figure 209: Line and Filling toolbar

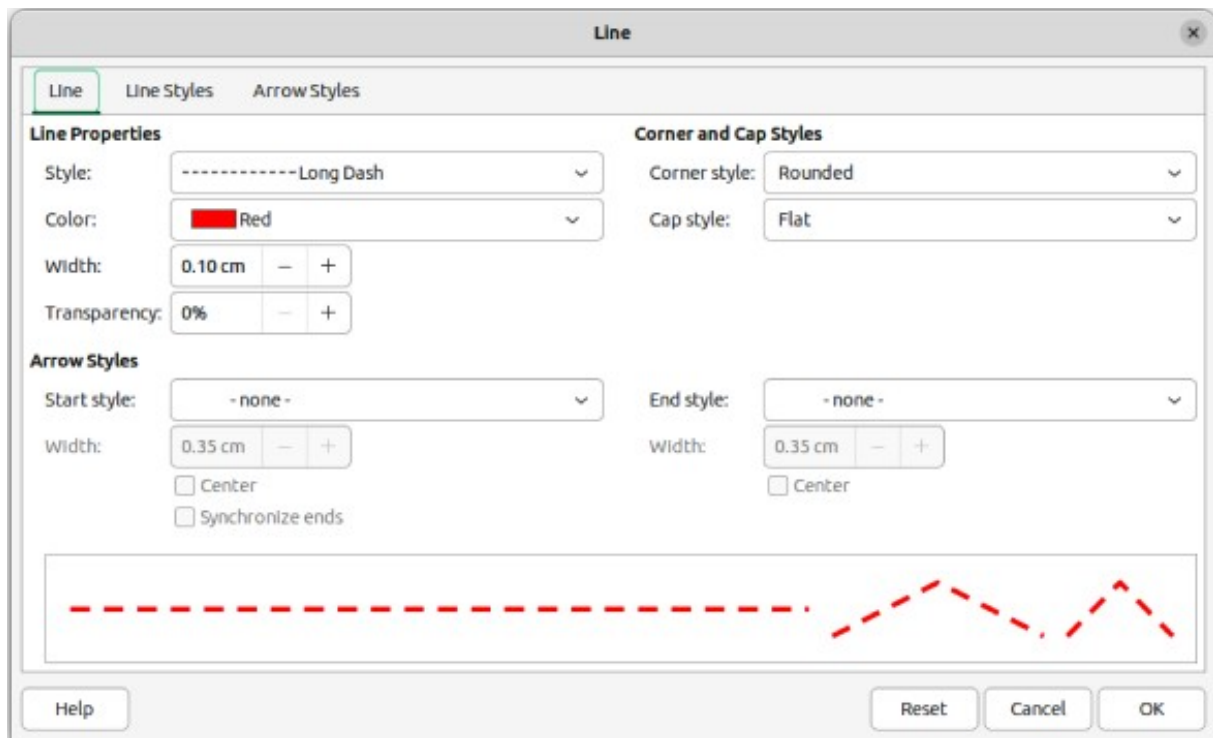

Figure 210: Line dialog for text box border

- 4) In **Line Width** on the Line and Filling toolbar, enter a line width for the text box border.
- 5) In **Line Color** on the Line and Filling toolbar, select a color from one of the available color palettes, or create a custom color.
- 6) Click outside the text box to exit edit mode and save the changes.

Line dialog

- 1) Click on a text box to select it and display the border indicating that the text box is in edit mode.
- 2) Open the Line dialog (Figure 210) using one of the following methods:
 - Right-click on the text box border and select **Line** from the context menu.
 - Go to **Format > Line** on the Menu bar.
- 3) Click on **Line** to open the Line page.
- 4) In **Style**, select a line style from the drop-down list to use as a text box border.
- 5) In **Color**, select a color for the line style from one of the available color palettes, or create a custom color.
- 6) In **Width**, enter a width for the line style selected.
- 7) In **Transparency**, enter a percentage value for the line style, if required.
- 8) In **Corner Style**, select the type of corner style from the drop-down list.
- 9) Click **OK** to save the changes and close the Line dialog, then click outside the text box to exit edit mode.

✓ Note

For a corner style to be clearly visible in a text box border, it is recommended to set the line width to a thickness above 0.35cm, as shown in Figure 211.

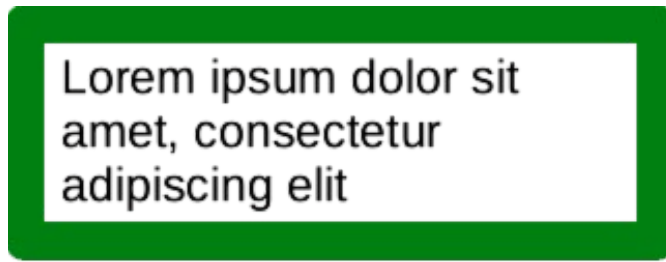

Figure 211: Example of using rounded corners

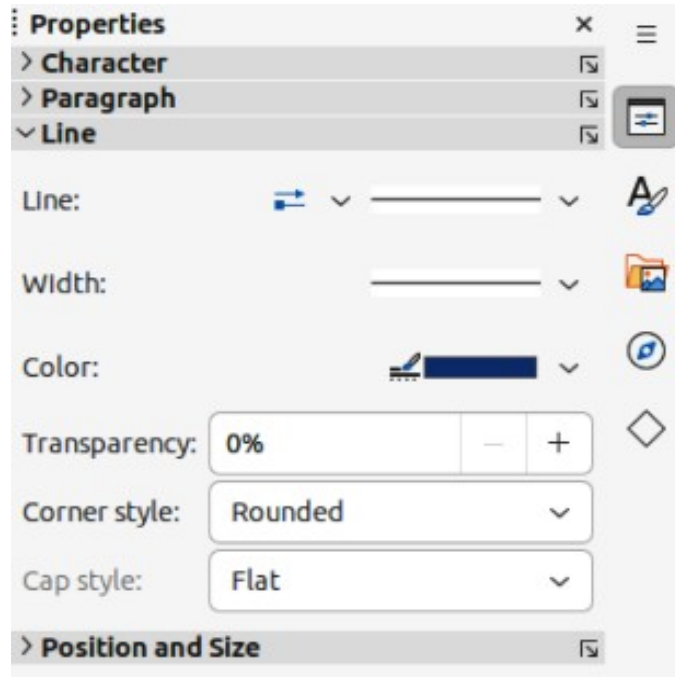

Figure 212: Line panel in Properties deck on Sidebar

Line panel in Sidebar

- 1) Click on a text box to select it and display the border indicating that the text box is in edit mode.
- 2) In the Sidebar, click on **Properties** to open the Properties deck in the Sidebar, then click on **Line** to open the **Line** panel (Figure 212).
- 3) In *Line*, select a line style from the drop-down list to use as a text box border.
- 4) In *Width*, enter a width for the line style selected.
- 5) In *Color*, select a color for the line style from one of the available color palettes, or create a custom color.
- 6) In *Transparency*, enter a percentage value for the line style, if required.
- 7) In *Corner Style*, select the type of corner style from the drop-down list, as shown by the example in Figure 211.
- 8) Click outside the text box to exit edit mode.

Moving text boxes

- 1) Click on a text box to select it and display the border indicating that the text box is in edit mode.

- 2) Move the cursor over the border. The cursor changes shape to the move symbol for the computer setup (for example, a clenched hand).
- 3) Click on the border and drag the text box to a new position in the drawing. A ghosted outline of the text box shows where it will be placed (Figure 213).
- 4) Release the text box when it is in the required position.
- 5) To accurately position a text box, use the Position and Size dialog, or the **Position and Size** panel in the Properties deck on the Sidebar. See Chapter 3, Working with Objects for more information.
- 6) When the text box is in the required position, click outside the text box to save the changes and deselect the text box.

Resizing text boxes

- 1) Click on a text box to select it and display the border indicating that the text box is in edit mode.
- 2) Move the cursor over one of the selection handles. The cursor changes shape to the resizing symbol for the computer setup (for example, a double-headed arrow). The selection handles are used to resize the text box as follows:
 - Corner handles change the width and height of the text box simultaneously.
 - Top and bottom selection handles change the height of the text box.
 - Right and left selection handles change the width of the text box.

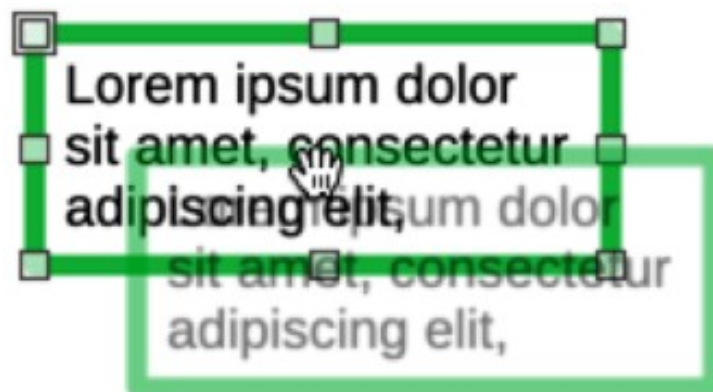

Figure 213: Example of moving a text box

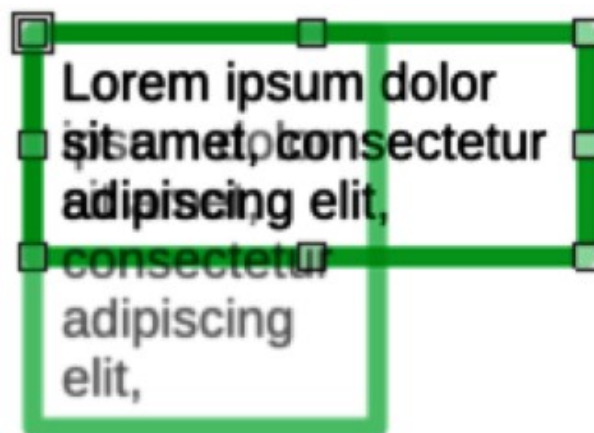

Figure 214: Example of resizing a text box

- 3) Click and drag the border to a new position to resize the text box. A ghosted outline of the text box shows is displayed as the text box is resized (Figure 214).
- 4) Release the text box when it reaches the required size.
- 5) To accurately resize a text box, use the Position and Size dialog, or the **Position and Size** panel in the Properties deck on the Sidebar. See Chapter 3, Working with Objects for more information.
- 6) When the text box is at the required size, click outside the text box to save the changes and deselect the text box.

✓ Note

Press and hold the *Shift* key to maintain text box proportions, then click and drag a selection handle to resize. Release the cursor before releasing the *Shift* key.

Rotating text boxes

- 1) Click on a text box to select it and display the border indicating that the text box is in edit mode.
- 2) Click again on the text border and the selection handles change shape and color to indicate rotation mode.
- 3) Click on a corner selection handle and drag to rotate the text box. A ghosted outline of the text box being rotated appears (Figure 215) and the current angle of rotation is shown in the status bar.
- 4) Release the text box is at the desired rotation angle.
- 5) To accurately rotate a text box, use the Rotation page in Position and Size dialog, or the **Position and Size** panel in the Properties deck on the Sidebar. See Chapter 3, Working with Objects for more information.



Figure 215: Example rotating a text box

✓ Note

When in rotation mode, the top, bottom, and side selection handles, though visible, are not available for rotating a text box. Also, text boxes cannot be sheared, slanted, or flipped vertically/horizontally.

Formatting text boxes

Text boxes are treated the same as other basic shapes in a drawing when formatting the area fill or borders of a box. See Chapter 3, Working with Objects for more information on formatting the area fill or borders of a text box. After formatting the text box to match the drawing requirements, format the text attributes to make the text appear correctly inside the text box:

- 1) Select a text box and use one of the following methods to open the Text dialog (Figure 216).
 - Right-click on the text box and select **Text Attributes** from the context menu.
 - Go to **Format > Text Attributes** on the Menu bar.
- 2) Click on **Text** in the Text dialog to open the **Text** page and access to the formatting options.
- 3) If required, click on **Text Animation** to open the **Text Animation** page to access options for animating the text. For more information on using text animation in a drawing, see “Text animation” on page 221.
- 4) If required, click on **Text Columns** to open the **Text Columns** page to access the options for creating columns in a text box. For more information on using text columns in a drawing, see “Text columns” on page 218.

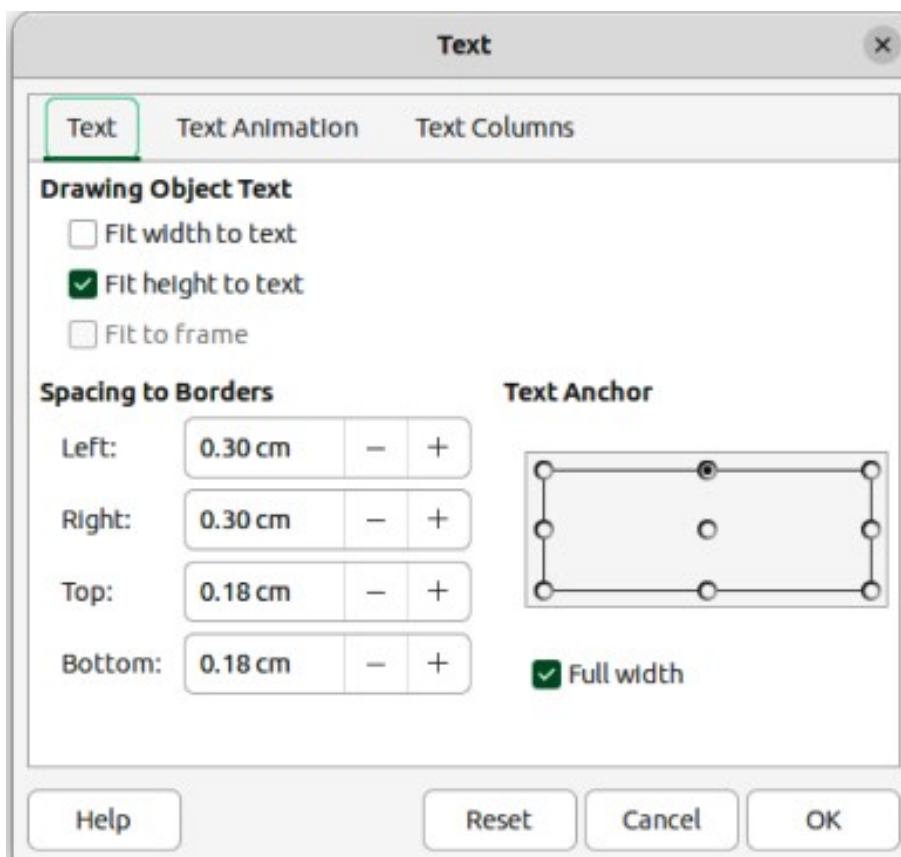

Figure 216: Text dialog — Text page — formatting text boxes

- 5) Click **OK** to save the changes to text attributes and close the Text dialog.
- 6) Click in a blank space to deselect the text box and end the text editing mode.

Text box formatting options

Drawing Object Text

Fit width to text

Expands or reduces text box width to match the length of the text, if the text box is smaller or larger than the text. Can be used with *Fit height to text* to automatically adjust width and height of the text box to the text.

Fit height to text

Expands or reduces the text box height to match the height of the text, if the text box is smaller or larger than the text. Can be used with *Fit width to text* to automatically adjust width and height of the text box to the text.

Fit to frame

Resizes text width and height to fit the entire area of the text box without changing the text box width or height. This option is not available if *Fit width to text* and/or *Fit height to text* options are selected.

Spacing to Borders

Specify the amount of space to leave between the text and the borders of the text box.

Text Anchor

Anchors the text to one of nine positions within the text box. The left and right anchor positions can only be selected when **Full width** is not selected. A text anchor only determines the position of the text within the text box and does not change the paragraph alignment of the text inside the text box.

Full width

When selected, the text box width expands to fit the longest paragraph of text inside the text box as a single line. When selected, only the top, middle or bottom center positions in **Text Anchor** can be used to anchor the text inside the text box.

Deleting text boxes

- 1) Click on the text box so that the selection handles are visible indicating that the text box is in edit mode.
- 2) Press the *Delete* or *Backspace* key. The text box is deleted without any warning.

Text in Draw objects

Note

Text can be added to most Draw objects. However, text cannot be added to 3D objects, or control elements such as buttons.

By default, an object is not dynamic when first created in Draw and does not behave like a text box. Also, text does not word wrap inside an object. To keep text within the borders of an object, use word wrap, paragraphs, line breaks, smaller text size, increasing object size, or a combination of all methods. Actual method method available depends on the type of Draw object selected.



Figure 217: Example of text word wrap inside an object

- 1) No word wrap
- 2) Word wrap to shape applied

Adding text to objects

An example of adding text into a Draw object is shown in Figure 217. The left object does not have the word wrap option applied and the right object has the word wrap option applied.

- 1) Create an object in a drawing and make sure the object is selected with the selection handles displayed.
- 1) Enter text mode on the selected object using one of the following methods:
 - Click on **Insert Text Box** for horizontal text, or **Insert Vertical Text** for vertical text on the Drawing or Text toolbar.
 - For horizontal text, double-click on the selected object.
 - For horizontal text, use the keyboard shortcut *F2*.
 - For vertical text, double-click on the selected object and click on **Insert Vertical Text** on the Drawing or Text toolbar.
- 2) Type or paste text into the selected object.
- 3) Format the text using the various tools on the Text Formatting toolbar, the panels in the Properties deck on the Sidebar, or the options in **Format** on the Menu bar. For more information on text formatting, see “Formatting text” on page 211.
- 4) If the text goes outside the object borders, click on **Text** in the Text dialog to open the **Text** page (Figure 218) and access text formatting options for a Draw object.
- 5) If required, click on **Text Animation** to open the **Text Animation** page and access animation options for text. For more information on using text animation in a drawing, see “Text animation” on page 221.
- 6) If required, click on **Text Columns** to open the **Text Columns** page and access options for creating columns inside an object. For more information on using text columns in a drawing, see “Text columns” on page 218.

Text options for objects

Custom Shape Text

Word wrap text in shape

Wraps text to fit inside an object. For example, if the width of the object is changed, then the height of the object either increases or decreases allowing for the increase or decrease in the number of text lines.

Resize shape to fit text

Resizes the object to fit the text that is being entered into the object. For example, if the object already contains one multi-line paragraph of text and this option is selected, then the object width expands and the height decreases until the text is a single line of text.

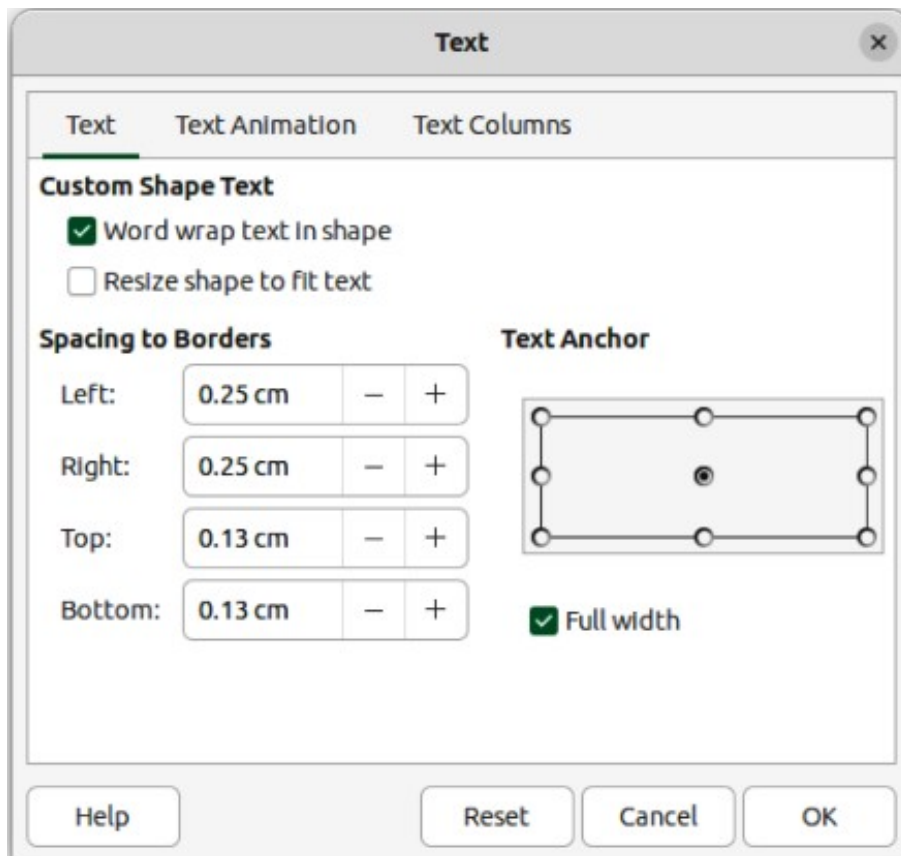

Figure 218: Text dialog — Text page — adding text to objects

Spacing to Borders

Specify the amount of space to leave between the text and the borders of the object.

Text Anchor

Anchors the text to one of nine positions within the text box. The left and right anchor positions can only be selected when *Full width* is not selected. A text anchor only determines the position of the text within the text box and does not change the paragraph alignment of the text inside the object.

Full width

When selected, the object width expands to fit the longest paragraph of text inside the object as a single line. When selected, only the top, middle or bottom center positions in **Text Anchor** can be used to anchor the text inside the text box.

Pasting text

Text is pasted into a text box or object by copying text from another object, drawing, or document. Pasted text retains formatting from the source drawing or document and may not match formatting of the text already in use. It is good practice to paste text without formatting and apply formatting later to match any text already in a drawing.

✓ Note

Using **Format > Paste** on the Menu bar, or the keyboard shortcut *Ctrl+V* (macOS *⌘+V*) pastes copied text directly into a drawing and NOT into an object, creating an OLE object. When creating text boxes or adding text to Draw objects, it is recommended to paste text into Draw as unformatted text.

- 1) Copy and paste text as unformatted text into a drawing, or draw object using one of the following methods:
 - Go to **Edit > Paste Special > Paste Unformatted Text** on the Menu bar.
 - Go to **Edit > Paste Special > Paste Special** on the Menu bar to open the Paste Special dialog. Select *Unformatted text* and click **OK** to close the dialog.
 - Use the keyboard shortcut *Ctrl+Shift+V* (macOS *⌘+Shift+V*) and the Paste Special dialog opens. Select *Unformatted text* and click **OK** to close the dialog.
 - Click on the triangle ▼ on the right of **Paste** on the Standard toolbar and select **Unformatted text** from the context menu.
- 2) Format the pasted text to the drawing requirements, or apply a drawing style. Unformatted text is pasted into a text box at the cursor position, or inside a selected object and formatted to the default drawing style.

Formatting text

Text formatting gives a drawing a more consistent and professional look without any distracting elements. Text formatting tools are available on the Text Formatting toolbar and drop-down menus in **Format** on the Menu bar. For more information on text formatting, see the *Writer Guide*.

If there are several text boxes and/or objects in a drawing that require the same text formatting, it is recommended to use drawing styles. For more information on using and creating styles, see Chapter 4, Changing Object Attributes.

Quick font resizing

After selecting text, is quickly increase or decrease font size using the tools **Increase Font Size** (*Ctrl+]*) (macOS *⌘+]*) and **Decrease Font Size** (*Ctrl+[*) (macOS *⌘+[*) on the Text Formatting toolbar. Changing font size depends on the standard sizes available for the font in use.

Selecting text

Text must be selected before it can be formatted using one of the following methods. Any formatting changes apply only to the selected text.

- To format all the text in a text box or object, click once on the border of the text box or object to display the selection handles. Any formatting changes then apply to all text in the text box or object.
- To format only part of the text, select text using one of the following methods:
 - Click in the text and drag the cursor over the text to highlight the text.
 - Double-click on text to select a complete word, or triple-click to select a whole paragraph.
 - Click in the text, then press and hold the *Shift* key and use the arrow keys to select text.

Paragraph formatting

Direct formatting

Direct text formatting is applied directly to characters, words, sentences, and paragraphs overriding any formatting that has been applied using styles.

- 1) Select the text (see “Selecting text” above) and format using one of the following methods:
 - Various formatting tools on the Text Formatting toolbar.
 - Go to **Format** on the Menu bar and select a formatting option from the drop-down menu. Selecting a formatting option opens either a context menu, or dialog providing further formatting options to apply to the selected text.
 - Use the options in the Paragraph and Character dialogs.
 - Use the options in the **Paragraph** and **Character** panels in the Properties deck on the Sidebar.
- 2) Click outside the text box, or object to deselect the text edit mode.

Paragraph dialog

- 1) Click anywhere in the paragraph being formatted.
- 2) Use one of the following methods to open the Paragraph dialog (Figure 219).
 - Right-click on the selected text and select **Paragraph** from the context menu.
 - Go to **Format > Paragraph** on the Menu bar.
- 3) Use the various options on the tabbed pages of the Paragraph dialog to format the text.
- 4) Click **OK** to save the changes and close the Paragraph dialog.
- 5) Click outside the text box or object to deselect the text.

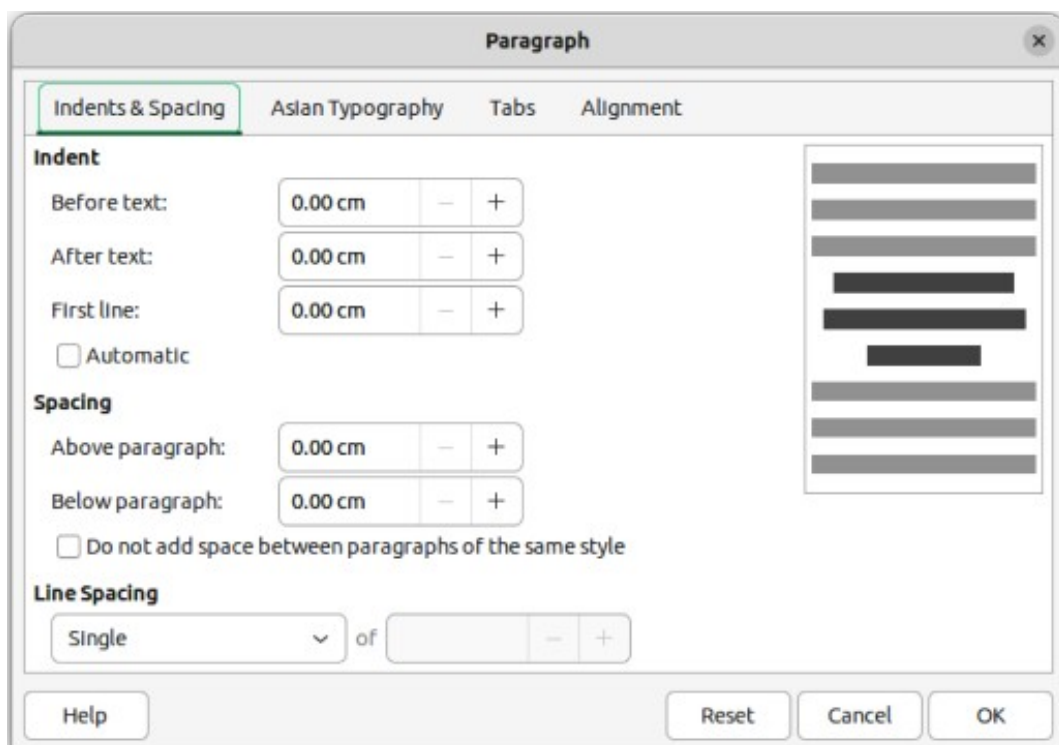

Figure 219: Paragraph dialog — Indents & Spacing page

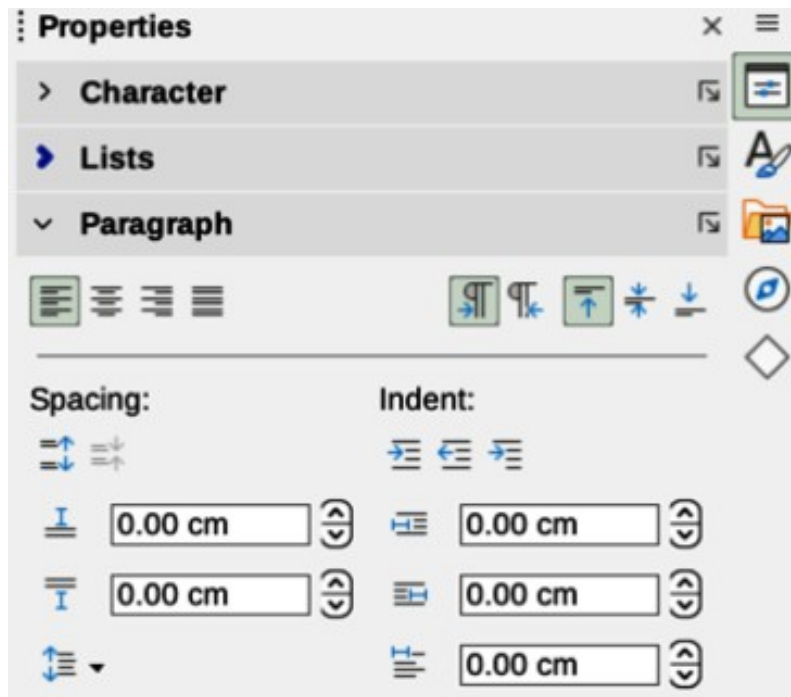

Figure 220: Paragraph panel in Properties deck on Sidebar

✓ Note

For information on the various formatting options available for text in the pages of the Paragraph dialog, refer to the *Writer Guide*.

Paragraph panel in Sidebar

An alternative method of formatting paragraphs is to use the **Paragraph** panel (Figure 220) in the Properties deck on the Sidebar. Formatting options are limited, but similar in use to the formatting options available in the Paragraph dialog. Any formatting applied to a paragraph using the Sidebar is immediate.

- 1) Click anywhere in the paragraph being formatted.
- 2) On the Sidebar, click on **Properties** to open the Properties deck.
- 3) If necessary, click on the expansion symbol on the left of the **Paragraph** title bar to open the **Paragraph** panel.
- 4) Format the text using the various options available in the **Paragraph** panel.
- 5) If necessary, click on **More Options** on the right of the title bar to open the Paragraph dialog to format text.

✓ Note

For information on the various formatting options available for text in the Paragraph panel on the Sidebar, refer to the *Writer Guide*.

Character formatting

Direct formatting

Direct or manual character formatting is applied to individual characters and words. Direct character formatting overrides any formatting that has been applied using paragraph formatting and drawing styles.

- 1) Select the characters for formatting, see “Selecting text” on page 211 for more information.
- 2) Format characters using one of the following methods.
 - The various formatting tools on the Text Formatting toolbar. Formatting applied to characters is immediate.
 - Go to **Format** on the Menu bar. Selecting a formatting option opens either a context menu or dialog where further formatting options are selected.
 - Use the options available in the Character dialog. Clicking **OK** on the dialog applies the formatting changes.
 - Use the options available in the **Character** panel in the Properties deck on the Sidebar. Formatting applied to characters is immediate.
- 3) Click outside the text box or object to deselect the text.

Character dialog

- 1) Select the characters for formatting and open the Character dialog (Figure 221) using one of the following methods:
 - Right-click on the characters and select **Character** from the context menu.
 - Go to **Format > Character** on the Menu bar.
- 2) Use the options on the tabbed pages of the Character dialog to format the selected characters.

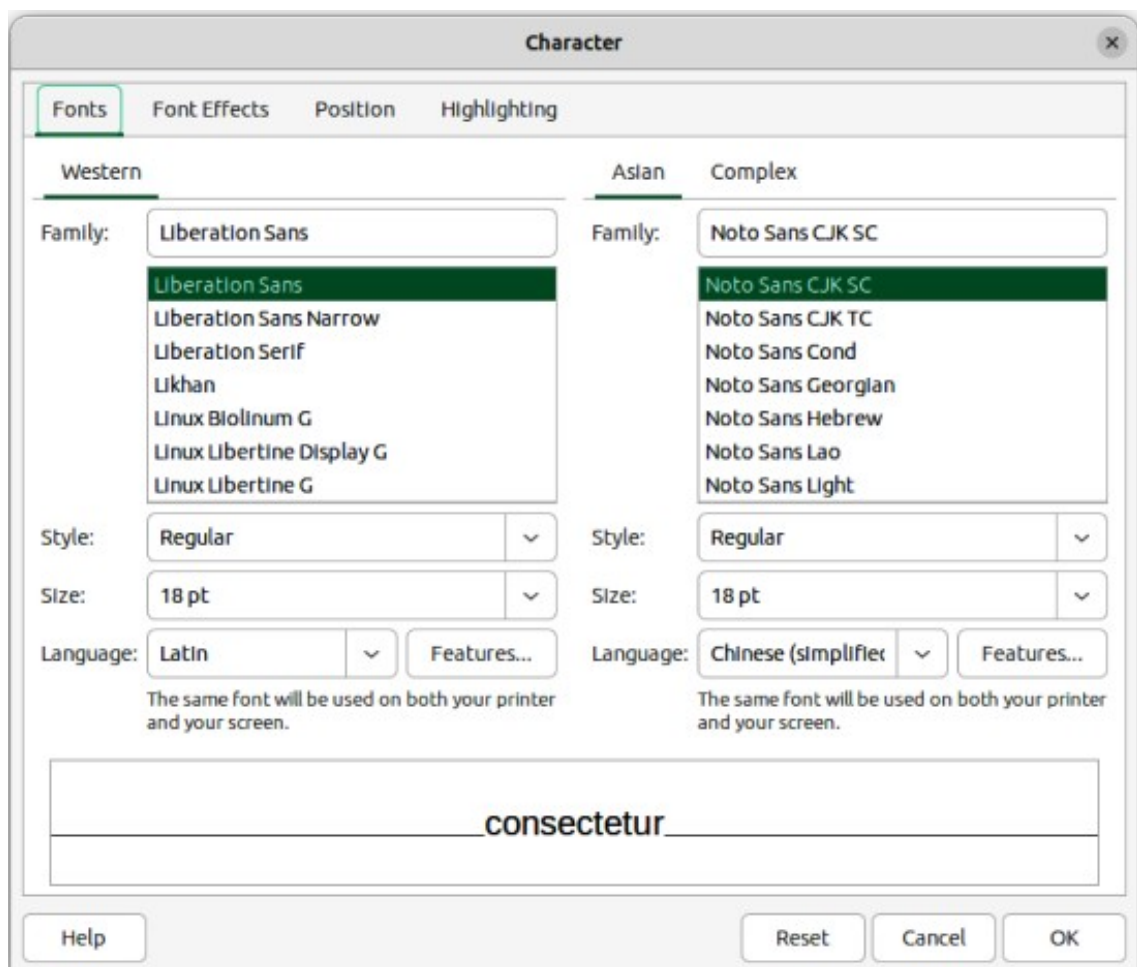

Figure 221: Character dialog — Fonts page

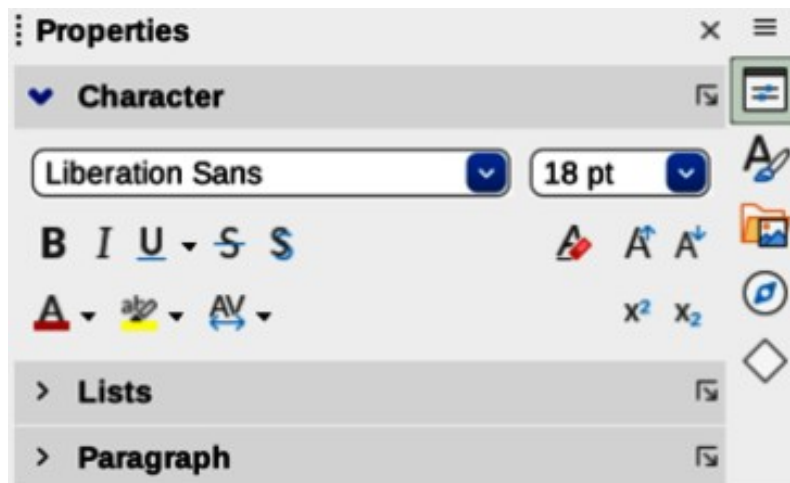

Figure 222: Character panel in Properties deck on Sidebar

- 3) Click **OK** to apply the formatting changes and close the dialog.
- 4) Click outside the text box or object to deselect the text.

✓ Note

For information on the various formatting options available for characters in the pages of the Character dialog, refer to the *Writer Guide*.

Sidebar Character panel

An alternative method of formatting text is to use the **Character** panel (Figure 222) in the Properties deck on the Sidebar. The formatting options available are limited, but similar in use to the formatting options available in the various pages of the Character dialog. Most of the options are also available on the Text Formatting toolbar.

- 1) Select a text box or object so that the selection handles on the border are displayed.
- 2) On the Sidebar, click on **Properties** to open the Properties deck.
- 3) Click on the expansion symbol on the left of the **Character** title bar to open the **Character** panel.
- 4) Format the text using the tools in the **Character** panel.
- 5) If necessary, click on **More Options** on the right of the title bar to open the Character dialog to format text.

✓ Note

For information on the various formatting options available for characters in the **Character** panel on the Sidebar, refer to the *Writer Guide*.

Unordered or ordered lists

Unordered (bulleted) and ordered (numbered) lists can be created in text boxes and objects. When creating lists in objects, Draw objects are not dynamic and do not automatically expand as a list is created.

Creating unordered or ordered lists in Draw is similar to LibreOffice Writer. For more information on unordered or ordered lists, see the *Writer Guide*.

Creating lists

Unordered or ordered lists are created in text boxes, or Draw objects as follows:

- 1) Select all the required text for a list.
- 2) Create a list using one of the following methods and default settings for lists:
 - Click on **Toggle Unordered List**, or **Toggle Ordered List** on the Text Formatting toolbar.
 - Click on **Toggle Unordered List**, or **Toggle Ordered List** in the **Lists** panel in the Properties deck on the Sidebar (Figure 223).
 - Go to **Format > Lists > Unordered List**, or **Ordered List** on the Menu bar.
- 3) To change the format of the list, click on the triangle ▼ on the right of the list icons and select a list style from the options available in the pop-up More Bullets dialog (Figures 224) or More Numbering dialog (Figure 225).



Figure 223: Lists panel in Properties deck on Sidebar

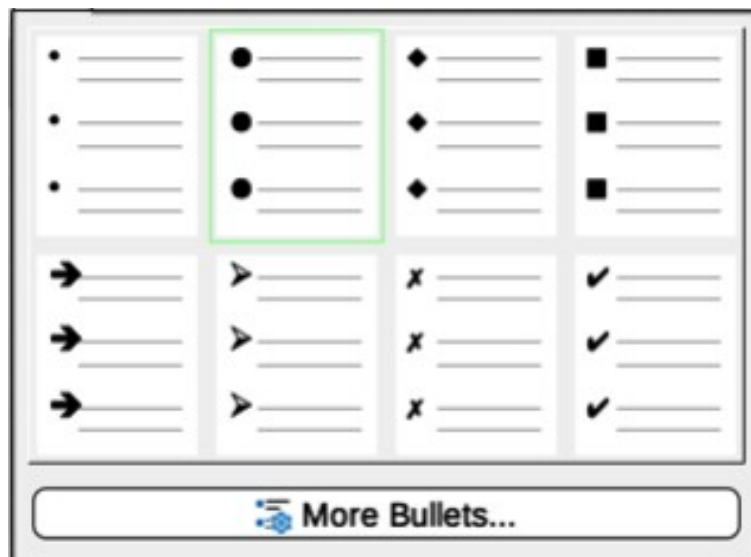

Figure 224: More Bullets dialog

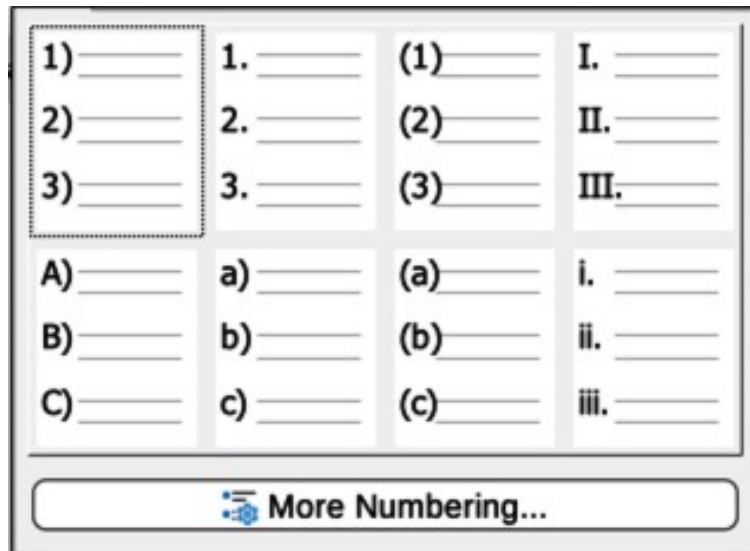

Figure 225: More Numbering dialog

Adjusting list item level and position

The level for each item in an unordered or ordered list is demoted or promoted within a list, or moved up or down in list order as follows:

- 1) Click on a list item being demoted, promoted, or moved up or down.
- 2) Demote a list item down one level at a time using one of the following methods:
 - Use the Tab key.
 - Go to **Format > Lists > Demote** on the Menu bar.
 - Use **Demote** in the **Lists** panel in the Properties deck on the Sidebar.
- 3) Promote a list item up one level at a time using one of the following methods:
 - Use the key combination *Shift+Tab*.
 - Go to **Format > Lists > Promote** on the Menu bar.
 - Use **Promote** in the **Lists** panel in the Properties deck on the Sidebar.
- 4) Change the position of a list item in the list order using one of the following methods:
 - Go to **Format > Lists > Move Up**, or **Move Down** on the Menu bar.
 - Use **Move Up**, or **Move Down** in the **Lists** panel in the Properties deck on the Sidebar.

Bullets and Numbering dialog

Use the Bullets and Numbering dialog (Figure 226) for more control over list formatting. Select text in a text box or object and open the dialog using one of the following methods:

- Go to **Format > Bullets and Numbering** on the Menu bar.
- Right-click on the selected text and select **Bullets and Numbering** from the context menu.
- Click on **More Options** on the right side of **Lists** panel title bar in the Properties deck on the Sidebar.

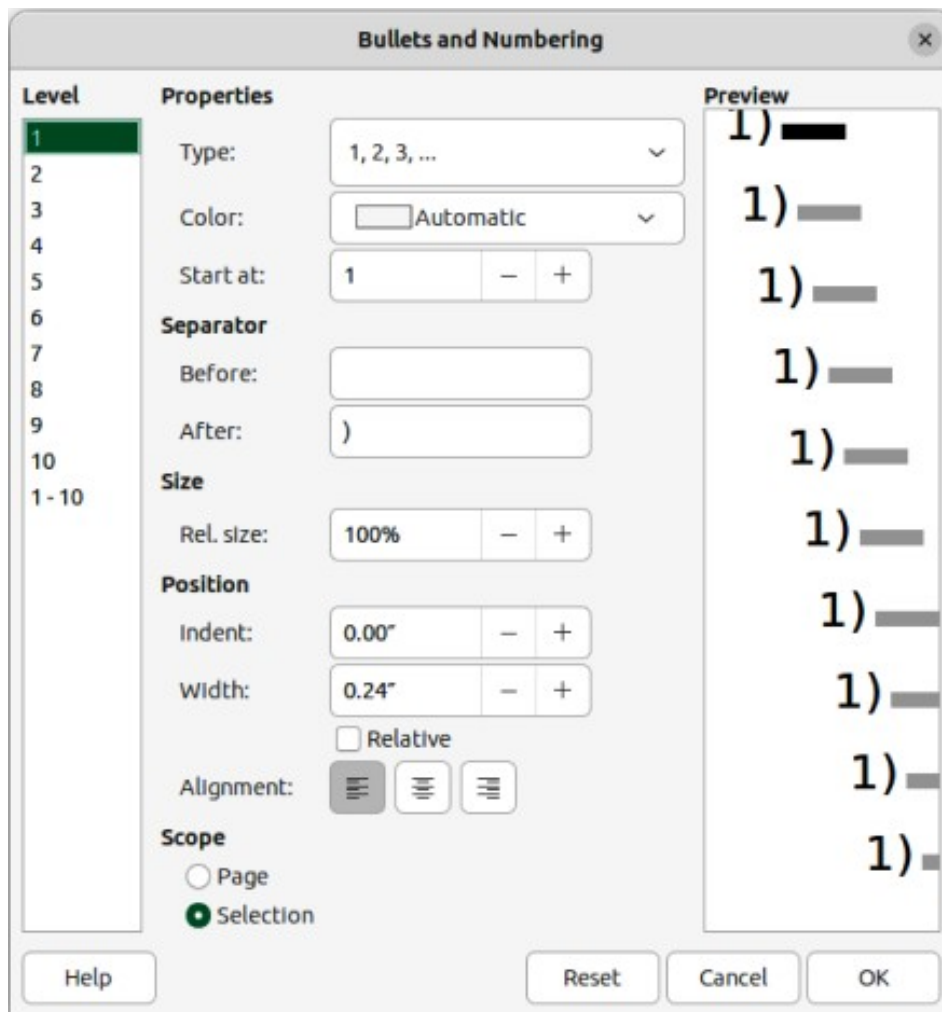

Figure 226: Bullets and Numbering dialog

- Click on **More Bullets** or **More Numbering** after clicking on the triangle ▼ on the right of **Toggle Unordered List**, or **Toggle Ordered List** on the Text Formatting toolbar, or in the **Lists** panel in the Properties deck on the Sidebar.

✓ Note

For more information on the options available in the Bullets and Numbering dialog for unordered or ordered lists, see the *Writer Guide*.

Text columns

Text in a drawing can be formatted into columns inside text boxes and objects. However, columns cannot be used on separate parts of text inside a text box or object. The whole of the text box, or object has to be used for columns. An example of text columns inside a Draw object is shown in Figure 227.

The type of columns used in Draw are continuous flow columns. This means that when text reaches the bottom of a column, text automatically flows into the next column as more text is added.

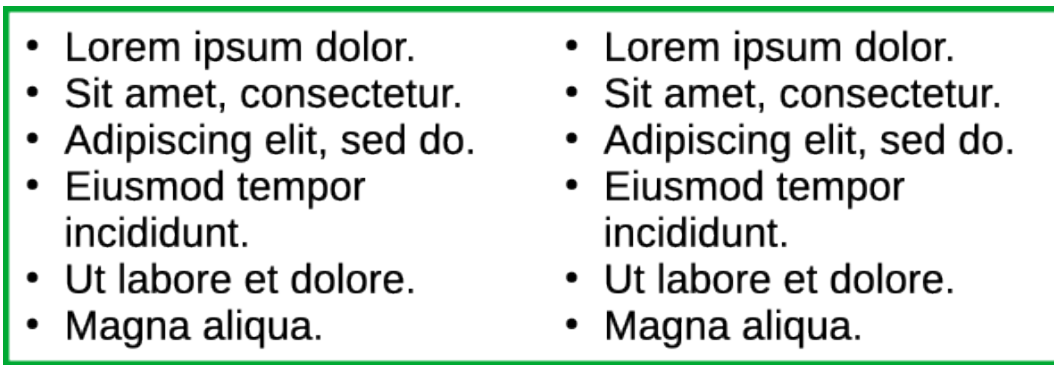

Figure 227: Example of text columns in a rectangle basic shape

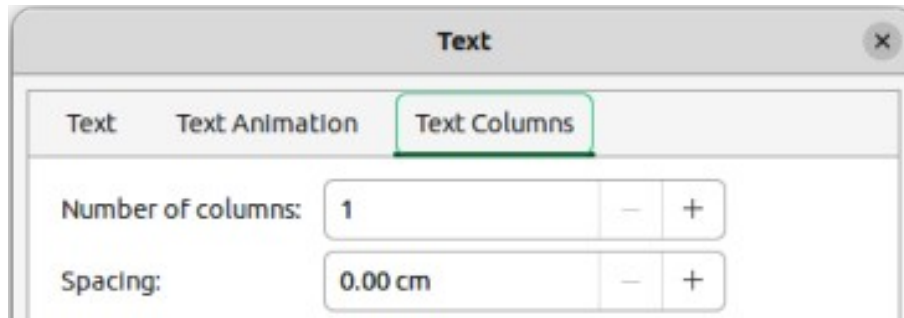

Figure 228: Text dialog — Text Columns page

Text boxes

- 1) Click the border of a text box to select it so that the selection handles are displayed indicating that the text box is in edit mode.
- 2) Open the options for text columns using one of the following methods:
 - Right-click in the text box and select **Text Attributes** from the context menu to open the Text dialog, then click on the **Text Columns** tab to open the **Text Columns** page (Figure 228),
 - Click on **Columns** in Properties on the Sidebar to open the **Columns** panel (Figure 229).
- 3) Set the number of columns required in the *Number of columns* box and the required spacing between the columns in the *Spacing* box.
- 4) Save the changes and deselect the text box using one of the following methods:
 - For the Text dialog, click **OK** to save the changes and close the dialog, then click outside the text box to deselect it.
 - For the **Columns** panel in the Properties deck on the Sidebar, click outside the text box to deselect it and save the changes.

✓ Note

Any text inside a text box, or drawing object automatically flows into column format when the changes are saved.

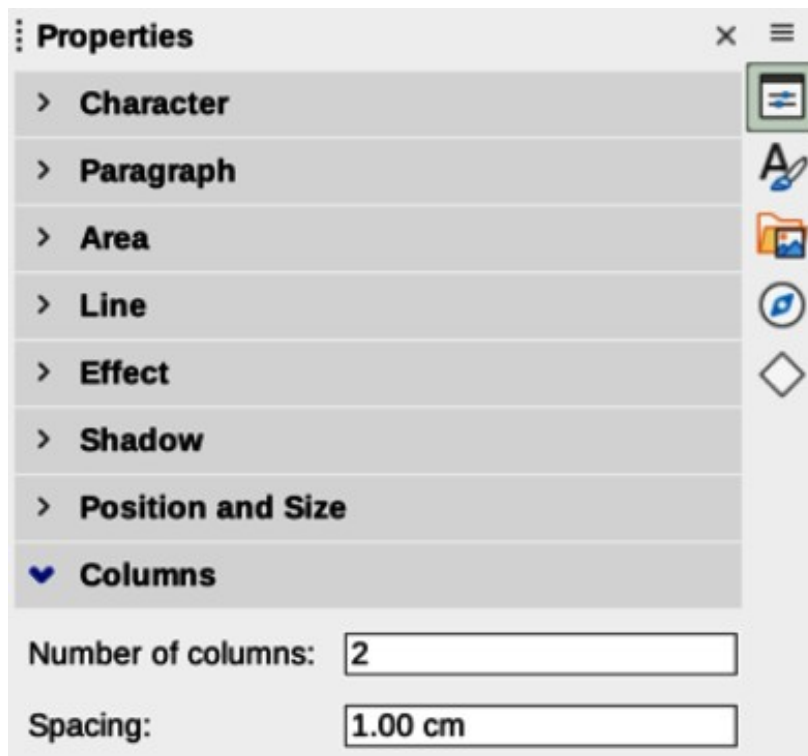

Figure 229: Columns panel in Properties deck on Sidebar

Drawing objects

- 1) Click on an object to select it so that the selection handles are displayed indicating that the object is in edit mode.
- 2) Double-click on the selected object to switch on text edit mode.
- 3) Open the options for text columns using one of the following methods:
 - Right-click in the drawing object and select **Text Attributes** from the context menu to open the Text dialog, then click on the **Text Columns** tab to open the **Text Columns** page (Figure 228),
 - Click on **Columns** in Properties on the Sidebar to open the **Columns** panel (Figure 229).
- 4) Set the number of columns required in the *Number of columns* box and the required spacing between the columns in the *Spacing* box.
- 5) Save the changes and deselect the object using one of the following methods:
 - For the Text dialog, click **OK** to save the changes and close the dialog, then click outside the object to deselect it.
 - For the **Columns** panel in the Properties deck on the Sidebar, click outside the object to deselect it and save the changes.
- 6) Double-click again on the object to switch on text edit mode.
- 7) Type or use copy and paste to enter the required text. Any text entered appears in column format.
- 8) If necessary, format the text to the drawing requirements.
- 9) Click outside the object to deselect it and save the changes.

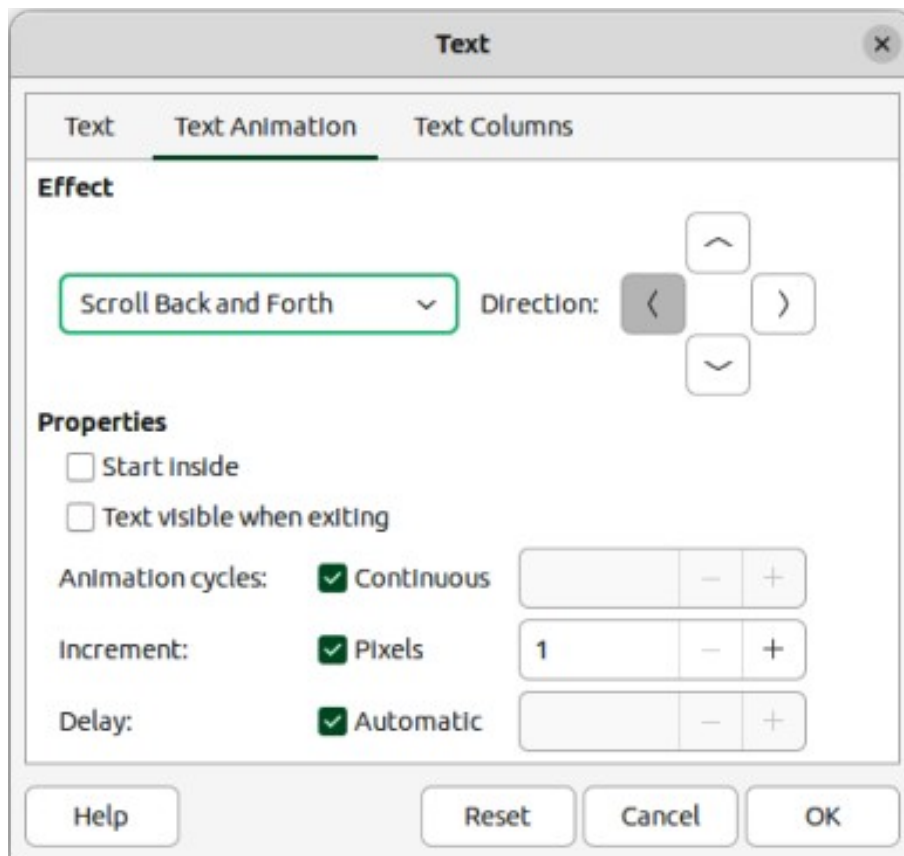

Figure 230: Text dialog — Text Animation page

Text animation

✓ Note

Text animation is not recommended in a drawing unless the drawing is going to be displayed as part of a presentation. See the *Impress Guide* for more information on text animation.

Creating text animation

- 1) Right-click on text in a text box, or drawing object and select **Text Attributes** from the context menu to open the Text dialog.
- 2) Click on **Text Animation** to open the **Text Animation** page in the Text dialog (Figure 230).
- 3) In **Effect**, select how the text appears during the text animation.
- 4) In *Direction*, select which direction the text appears from during animation.
- 5) In **Properties**, select *Start inside* for the text to be visible and inside the drawing object when applying the animation effect.
- 6) In **Properties**, select *Text visible when exiting* for the text to remain visible after applying the animation effect.
- 7) In *Animation cycles*, select either *Continuous*, or enter the number of animation cycles for the animated text.
- 8) In *Increment*, select the increment value in *Pixels* for scrolling the text.

- 9) In *Delay*, specify *Automatic*, or enter the time delay to wait before repeating the animation effect.
- 10) Click **OK** to save the changes and close the Text dialog.

Text animation options

Effect

Select the animation effect from the drop-down list to apply to the text in the selected drawing object. To remove an animation effect, select *No Effect*.

Direction

Select a scrolling direction for the animated text.

Properties

Start inside

Text is visible and inside the drawing object when applying the animation effect.

Text visible when exiting

Text remains visible after applying the animation effect.

Animation cycles

Set the looping options for the animation effect.

Continuous

Plays the animation effect continuously. To specify the number of times to play the animation effect, deselect this check box, and enter the number of cycles in the *Continuous* box.

Increment

Specifies the increment value in the *Pixels* box for scrolling the text.

Delay

Specifies the amount of time before repeating the animation effect.

Automatic

LibreOffice automatically determines the amount of time before repeating the animation effect. To manually assign a delay period, unmark this check box, and then enter a time value in the *Automatic* box.

Text callouts

A text callout is a short line of text connected by a line to highlight, or point out a feature of an illustration or drawing. Two types of text callouts (Figure 231) are available — **Callouts** for horizontal text and **Vertical Callouts** for vertical text. Text callouts in LibreOffice Draw are a legacy from the first versions of LibreOffice and are only available on the Text toolbar.

Note

Custom shape callouts can also be found by selecting **Callout Shapes** on the Drawing toolbar, or the **Callouts** panel in the Shapes deck on the Sidebar. These custom shape callouts have the same purpose as text callouts, but have different options available.

Creating text callouts

- 1) Click on **Callouts** for horizontal text, or **Vertical Callouts** for vertical text on the Text toolbar.
- 2) Click in the drawing and drag the cursor to create the callout.

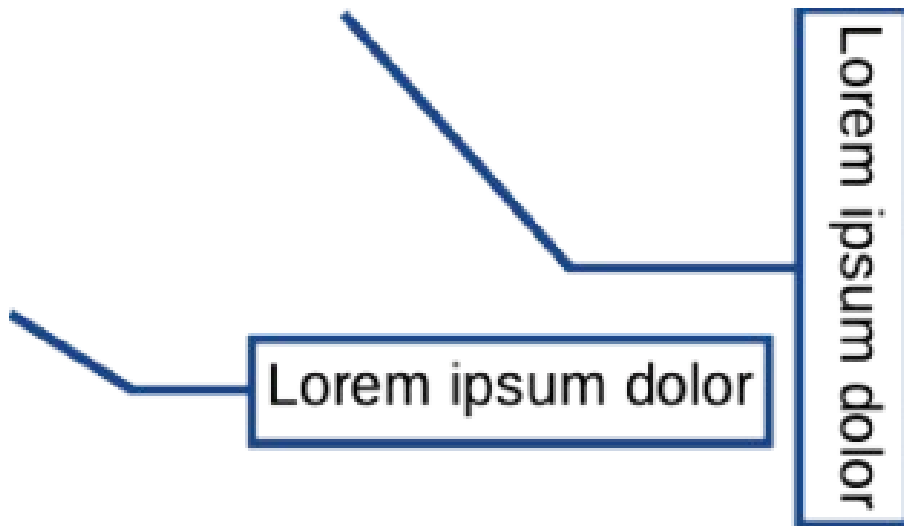

Figure 231: Example of horizontal and vertical text callouts

- 3) Double click in the callout box to enter text mode.
- 4) Type the required text, then click in a blank space in the drawing. The callout box adjusts its size horizontally and/or vertically to fit the text within the callout box.
- 5) Select the callout and click on the selection handle at the end of the connector line, then drag the end of the connector line to the required position.
- 6) With the callout still selected, click on the callout box and drag it to the required position.
- 7) Click in a blank space in the drawing to deselect the text callout and save the changes.

Editing text callouts

- 1) Double click in the callout box to enter text mode to edit and format the text. See “Formatting text” on page 211 for more information on text formatting.
- 2) Click in a blank space on the drawing to save the changes to the text.
- 3) Select the text callout so that the selection handles are displayed.
- 4) Right click on the selected text callout and select an option from the context menu to change the attributes for position, size, line, and area of the text callout. For more information, see Chapter 3, Working with Objects, and Chapter 4, Changing Object Attributes.
- 5) Click on the selection handle at the end of the connector line and drag it to change the position of the line end or the length of the connector line.
- 6) Select the text callout and open the Position and Size dialog (Figure 232) using one of the following methods:
 - Right-click on the selected callout and select **Position and Size** from the context menu.
 - Go to **Format > Position and Size** on the Menu bar.
 - Use the keyboard shortcut *F4*.

Note

The **Callout** page in the Position and Size dialog is only available when a text callout has been selected. It is not available for **Callout Shapes** that are available on the Drawing toolbar, or the **Callouts** panel in the Shapes deck on the Sidebar.

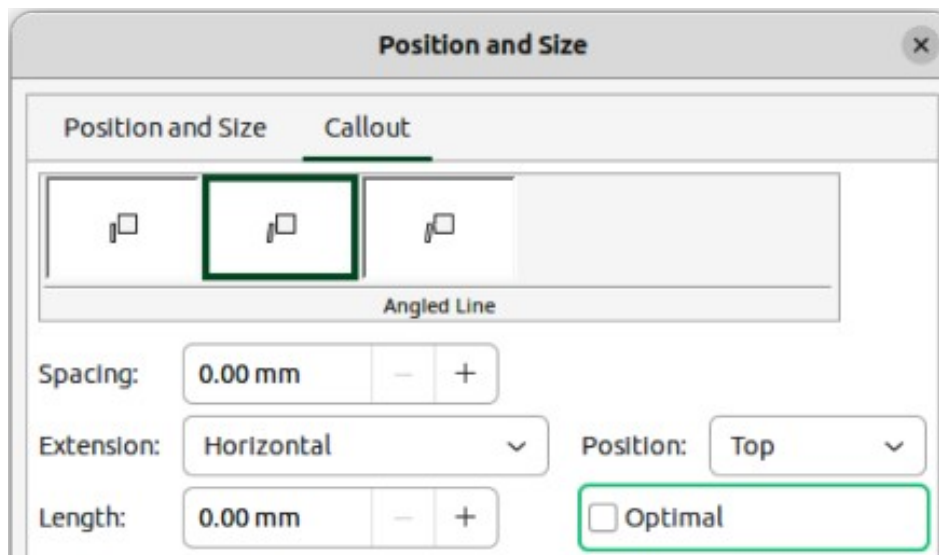

Figure 232: Position and Size dialog — Callout page

- 7) Click **Callout** to open the formatting options available for text callouts.
- 8) Select the style of text callout from **Straight Line**, **Angled Line**, or **Angled Connector Line**.
- 9) In **Spacing**, enter the amount of space required between the end of the callout line and the callout box.
- 10) In **Extension**, select from the available options how the callout line from extends the callout box.
- 11) If **From top**, or **From left** has been selected from the **Extension** drop-down list, enter a distance value in the **By:** box to create a space between the start point of the connector line and the callout box.
- 12) If **Horizontal**, or **Vertical** has been selected from the **Extension** drop-down list, enter a position setting from the **Position** drop-down list to set the position of where the connector line is attached to the text callout box.
- 13) In **Length**, enter the length of the callout line segment that extends from the callout box to the angle point of the connector line.

✓ Note

The **Length** option is only available if **Angled Connector Line** is selected as the callout style and the **Optimal** check box is not selected.

- 14) Select **Optimal** to display the angle point in a connector line at an optimal distance from the callout box.
- 15) Click in a blank space in the drawing to deselect the text callout and save the changes.

Text callout options

Callout Styles

Select the required callout style from the options available.

Spacing

Enter the amount of space required between the end of the callout line and the callout box.

Extension

Select where and how the callout line extends from the callout box.

Length

Enter the length of the callout line segment that extends from the callout box to the inflection point of the line.

Optimal

Select this option to display a single line in the optimum position.

✓ Note

The **Length** option is only available if **Angled connector line** is selected as the callout style and **Optimal** is not selected.

Tables in Draw

Tables provide information easily and quickly when used in a drawing. Tables can be added directly to a drawing eliminating the need to embed a Calc spreadsheet, or a Writer text table. However, it makes sense to embed a spreadsheet into a drawing, especially when greater functionality is required in the table. The tables provided by Draw do have a limited functionality.

Inserting tables

Tables are placed at the center of a drawing and cannot be placed into objects or shapes. Also, unlike text boxes and other objects, tables cannot be rotated.

✓ Note

When inserting tables into a drawing, the table is created using the default style with settings already applied. Currently these defaults are hard coded in LibreOffice. The table can be formatted to the drawing requirements after insertion.

Table dialog

- 1) Go to **Insert > Table** on the Menu bar to open the Insert Table dialog (Figure 233).
- 2) Enter the number of rows and columns required.
- 3) Click **OK** to insert the table in the center of a drawing and close the dialog.
- 4) Move the table into position by clicking on the border and dragging it to its new position.

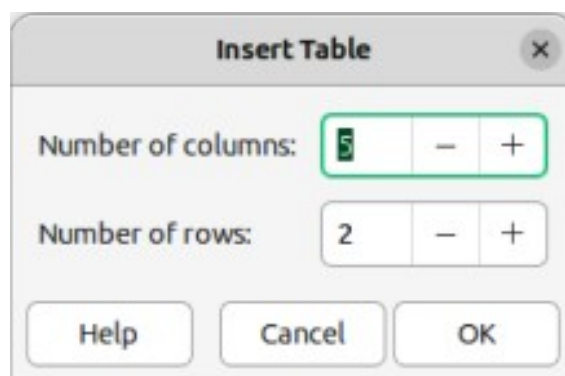

Figure 233: Insert Table dialog

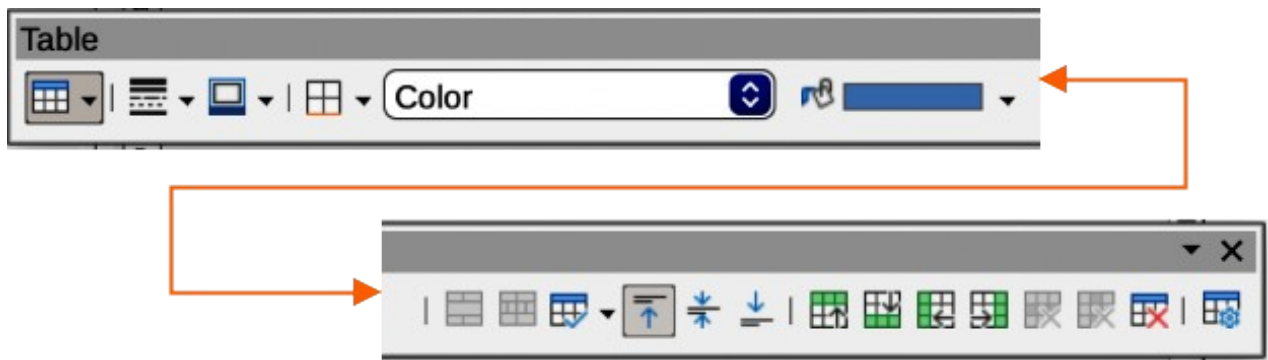

Figure 234: Table toolbar

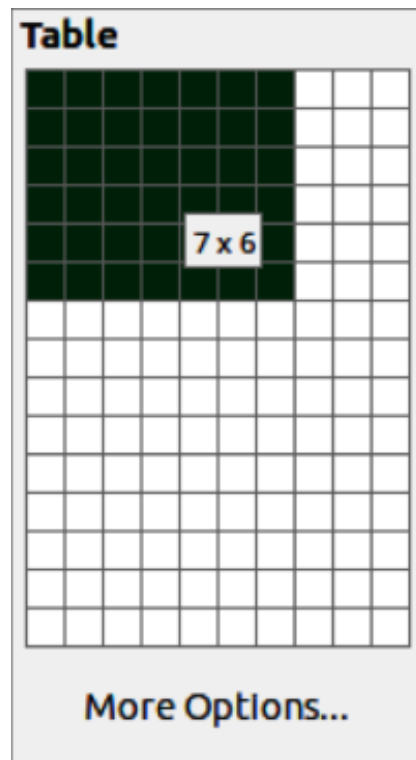

Figure 235: Table grid

Table grid

- 1) Click on **Table** on the Table toolbar (Figure 234), or Standard toolbar to open the **Table** grid (Figure 235).
- 2) Click and drag the cursor until the required number of columns and rows are selected,
- 3) Click again to insert the table into the center of a drawing and close the Table grid.
- 4) If necessary, click on **More Options** to open the Insert Table dialog to select the number of rows and columns required.
- 5) Move the table into position by clicking on the border and dragging it to its new position.

✓ Notes

If the Table toolbar is not visible, go to **View > Toolbars > Table** on the Menu bar. The Table toolbar is normally docked at the bottom of the Draw window.

The Table grid is only available on the Standard toolbar for computers using a Windows or Linux operating system.

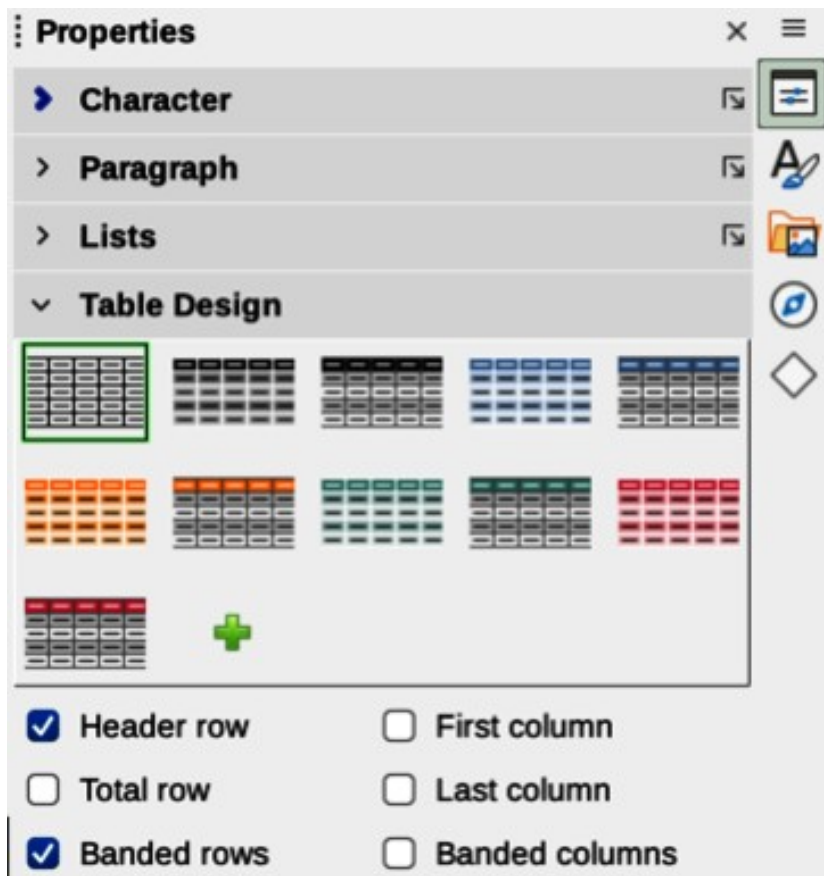

Figure 236: Table Design panel in Properties deck on Sidebar

Table Design panel

Several predefined table designs are provided in the **Table Design** panel in the Properties deck on the Sidebar (Figure 236). The **Table Design** panel is only available when a table is selected.

Inserting table designs

- 1) Insert a table into a drawing or select a table in a drawing.
- 2) Click on **Table Design** in the Properties deck on the Sidebar to open the **Table Design** panel.
- 3) Select a design for the table from the available design options.
- 4) Format the rows and columns using the available options listed below the **Table Design** panel.
- 5) Alternatively, right click on the selected table design and select the format options for the rows and columns from the context menu.

Creating table designs

- 1) Insert a table into a drawing, then select the new table.
- 2) Click on **Table Design** in the Properties deck on the Sidebar to open the **Table Design** panel, or click on Table Design on the Table toolbar.
- 3) Click on the plus sign in **Table Design** panel to create a new design.
- 4) Make sure the new design is selected, then format the rows and columns from the available options listed below the **Table Design** panel.

- 5) Alternatively, right click on the new table design and select the format options for the rows and columns from the context menu.

Table design options

Header row

Selected by default. The first row is normally a header row and is displayed with a different background from the rest of the table.

Total row

When selected, changes the background of the last row to make it stand out from other rows.

Banded rows

Selected by default. Alternate rows have different backgrounds making it easier to read data entered into the rows.

First column

When selected, highlights the first column of the table using a darker background.

Last column

When selected, highlights the last column of the table using a darker background.

Banded columns

When selected, alternate columns are highlighted with dark and light colors.

Table formatting

Format a selected table using the tools and options available on the Table toolbar, by going to **Format > Table** on the Menu bar, or using the options available in the Table Properties dialog.

Table toolbar

The Table toolbar (Figure 234 on page 226) automatically opens when a table is selected providing tools for creating and formatting a table. The default position for the toolbar is docked at the bottom of the Draw Workspace.

Table

Inserts a new table in a drawing using the Insert Table dialog or the Table grid. See “Inserting tables” on page 225 for more information on inserting tables.

Border Style

Changes the line style of the borders of selected cells. Click on the triangle ▼ next to **Border Style** to open a drop-down list and select from a range of predefined styles.

Border Color

Changes the color of the borders of selected cells. Click on the triangle ▼ next to **Border Color** to access the available LibreOffice color palettes. Select a color from a range of predefined palettes or create a custom color.

Borders

Selects a predefined border configuration for the selected table, or cells. Click on the triangle ▼ next to **Borders** to open a drop-down list to select a border configuration.

Area Style/Filling

Select the cells to be filled, then select the type of fill from the drop-down list: *None, Color, Gradient, Hatching, Bitmap, Pattern, Use Slide Background*.

Fill Color

Select a fill option from the drop-down menu. The fill options change to show the fillings available for each **Area Style/Filling** type.

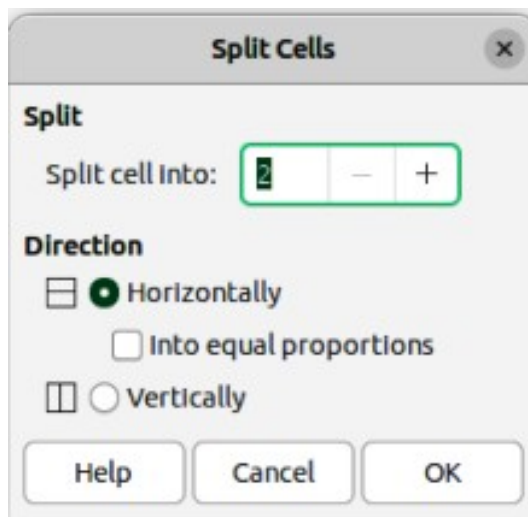

Figure 237: Split Cells dialog

Merge Cells

Merges the selected cells into one cell. Note that the contents of the merged cells are also merged. Alternatively, right-click on selected cells and select **Merge Cells** from the context menu.

Split Cells

Splits a selected cell into multiple cells either horizontally or vertically. Make sure the cursor is positioned on the cell, then click on **Split Cells** to open the Split Cells dialog (Figure 237).

In *Split cells into*, select the number of cells required when splitting a cell and whether to split the cell *Horizontally* or *Vertically*. If necessary, when splitting horizontally, select *Into equal proportions* to create cells of equal size. The contents of the split cell are kept in the original cell (left or top cell).

Optimize

Evenly distributes the selected rows and columns in a table either horizontally or vertically. Clicking on **Optimize** opens a pop-up toolbar which contains the following tools:

Minimal Row Height

Determines the minimal row height for selected rows. Minimal row height depends on the font size of the smallest character in the row.

Minimal Column Width

Defines the minimal column width for selected columns. Minimal column width depends on the shortest entry within a column.

Optimal Row Height

Determines the optimal row height for selected rows. Optimal row height depends on the font size of the largest character in the row.

Optimal Column Width

Defines the optimal column width for selected columns. Optimal column width depends on the longest entry within a column.

Distribute Rows Equally

Adjusts the height of the selected rows to match the height of the tallest row in the selection.

Distribute Columns Evenly

Adjusts the width of the selected columns to match the width of the widest column in the selection. The total width of the table cannot exceed the width of the page.

Align Top, Center Vertically, Align Bottom

Sets the vertical alignment of text in selected cells.

Insert Row Above, Insert Row Below

Click in a cell or cells to select rows and use these two tools to insert a row or rows above or below the selected rows. Alternatively, right-click on the selected rows and select **Insert > Insert Row Above** or **Insert Row Below**.

Insert Column Before, Insert Column After

Click in a cell or cells to select columns and use these two tools to insert a column or columns before or after the selected columns. Alternatively, right-click on the selected columns and select **Insert > Insert Column Before** or **Insert Column After**.

Delete Row, Delete Column, Delete Table

Click in a cell or cells to select rows or columns, then click on a tool to delete the selected rows or columns. To delete the whole table, place the cursor in a cell and select **Delete Table**. Alternatively, right-click on the selected cells and select **Delete > Delete Row**, or **Delete Column**, or **Delete Table** from the context menu.

Select Table, Select Column, Select Row

Select a table, column, or row if the same attributes are going to be applied to a table, column, or row.

Table Design

Clicking on this tool opens the **Table Design** panel in the Properties deck on the Sidebar. See “Table Design panel” on page 227 for more information.

Table Properties

Clicking on this tool opens the Table Properties dialog. Alternatively, right-click on the table and select **Table Properties** from the context menu.

Menu bar

Go to **Format > Table** on the Menu bar and select a formatting option from the submenu .

Minimal Row Height

Determines the minimal row height for selected rows. Minimal row height depends on the font size of the smallest character in the row.

Optimal Row Height

Determines the optimal row height for selected rows. Optimal row height depends on the font size of the largest character in the row.

Distribute Columns Evenly

Adjusts the width of the selected columns to match the width of the widest column in the selection. The total width of the table cannot exceed the width of the page.

Select Row

Selects the row or rows where cells have been selected in the table.

Insert Rows

Inserts rows in the table where cells have been selected in the table.

Delete Row

Deletes rows in the table where cells have been selected in the table.

Minimal Column Width

Defines the minimal column width for selected columns. Minimal column width depends on the shortest entry within a column.

Optimal Column Width

Defines the optimal column width for selected columns. Optimal column width depends on the longest entry within a column.

Distribute Columns Evenly

Adjusts the width of the selected columns to match the width of the widest column in the selection. The total width of the table cannot exceed the width of the page.

Select Column

Selects the column or columns where cells have been selected in the table.

Insert Columns

Inserts columns in the table where cells have been selected in the table.

Delete Column

Deletes columns in the table where cells have been selected in the table.

Merge Cells

Merges the selected cells into one cell. The contents of the merged cells are also merged. Alternatively, right-click on selected cells and select **Merge Cells** from the context menu.

Split Cells

Splits a selected cell into multiple cells either horizontally or vertically. Make sure that the cursor is positioned on the cell, then click on **Split Cells** to open the Split Cells dialog.

Delete Table

To delete the whole table, place the cursor in a cell and select Delete Table. Alternatively, right-click on the selected cells and select **Delete Table** from the context menu.

Select...

Selects the whole table.

Properties...

Opens the Table Properties dialog.

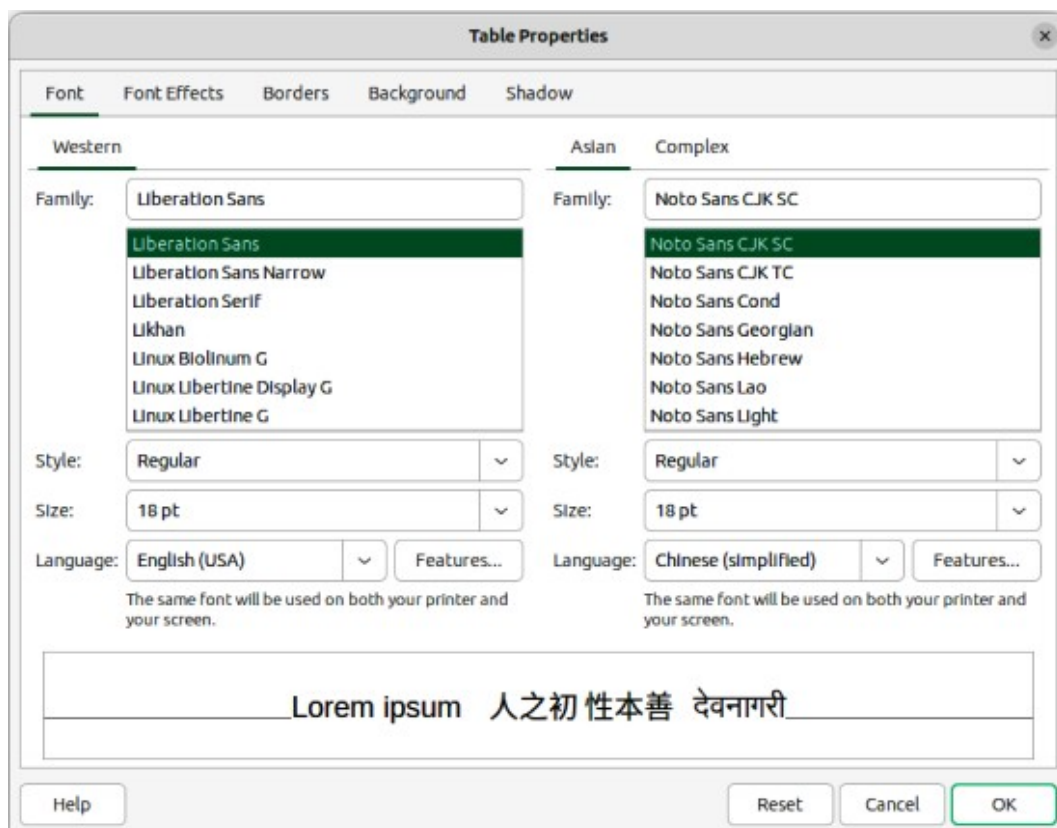

Figure 238: Table Properties dialog — Font page

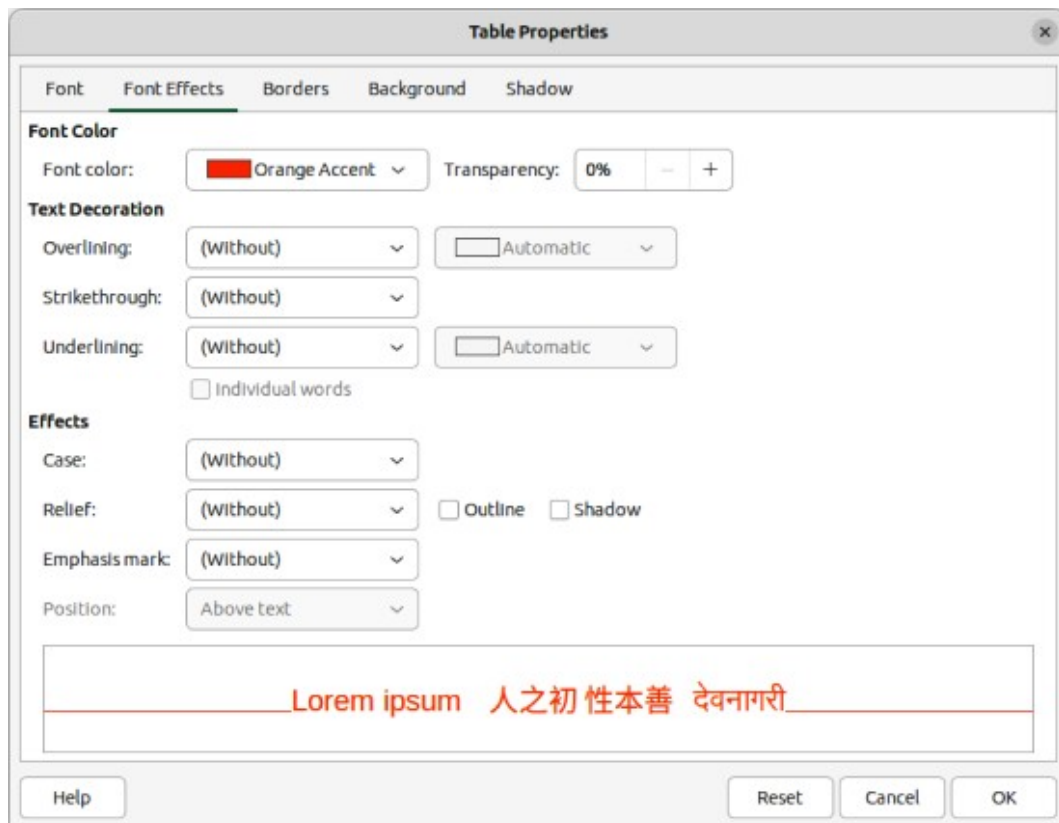

Figure 239: Table Properties dialog — Font Effects page

Table Properties dialog

The Table Properties dialog has five tabbed pages that provide formatting options for **Font**, **Font Effects**, **Borders**, **Background**, and **Shadow**. Open the Table Properties dialog using one of the following methods:

- Right-click in a table and select **Table Properties** from the context menu.
- Go to **Format > Table > Properties** on the Menu bar.
- Click on **Table Properties** on the Table toolbar.

The formatting options on each dialog page are as follows:

Font (Figure 238)

Select the required **Family**, **Style**, **Size**, and **Language** for text in the table. A sample of the font selected is displayed in the preview box. See the *Writer Guide* for more information on fonts.

Font Effects (Figure 239)

Select the required **Font Color**, **Text Decoration**, and **Effects** for the text in the table. A sample of the font effects applied to the text is displayed in the preview box. See the *Writer Guide* for more information on font effects.

Borders (Figure 240)

Select the required **Line Arrangement**, **Line**, and **Padding** for the table and cell borders. These options are similar to the tools **Border Style**, **Border Color**, and **Borders** on the Table toolbar. See Chapter 4, Changing Object Attributes for more information on the lines used for table and cell borders.

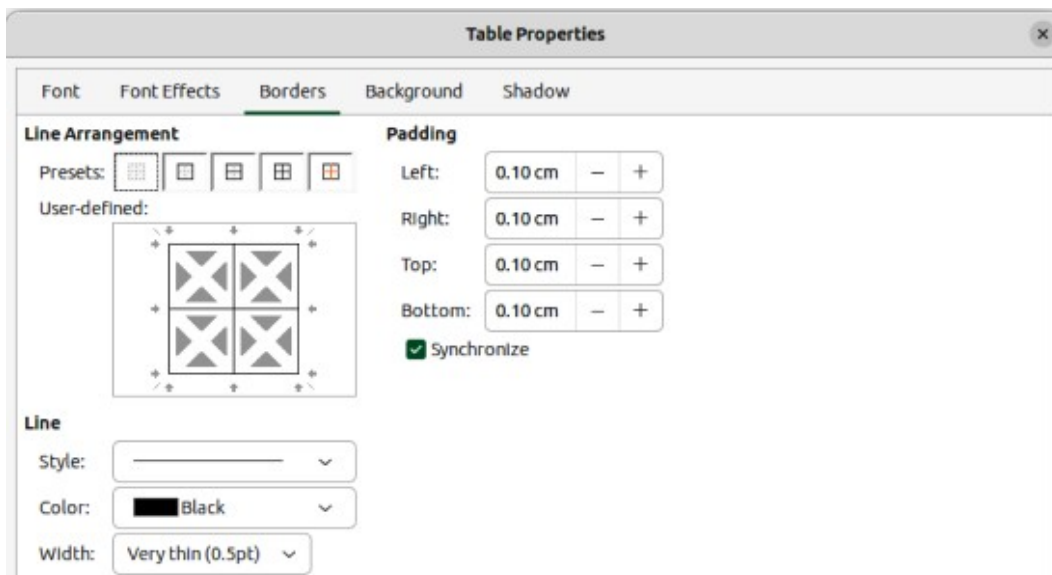

Figure 240: Table Properties dialog — Borders page

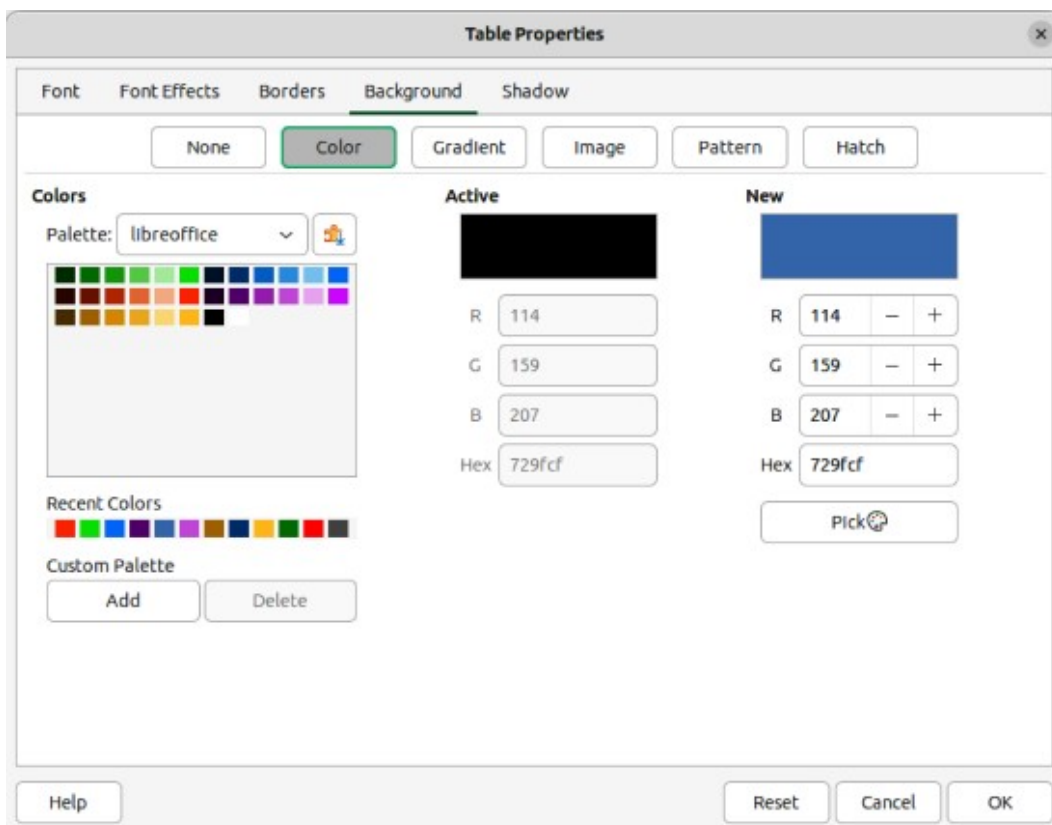

Figure 241: Table Properties dialog — Background page

Background (Figure 241)

Select a background as the area fill for the table and/or selected cells. This dialog page provides the same functions as **Area Style/Filling** tools on the Table toolbar. See Chapter 4, Changing Object Attributes for more information on area style and filling used for table and cell backgrounds.

Shadow (Figure 242)

Adds a shadow to the table. The options adjust the look and position of the shadow. See Chapter 4, Changing Object Attributes for more information on table shadows.



Figure 242: Table Properties dialog — Shadow page

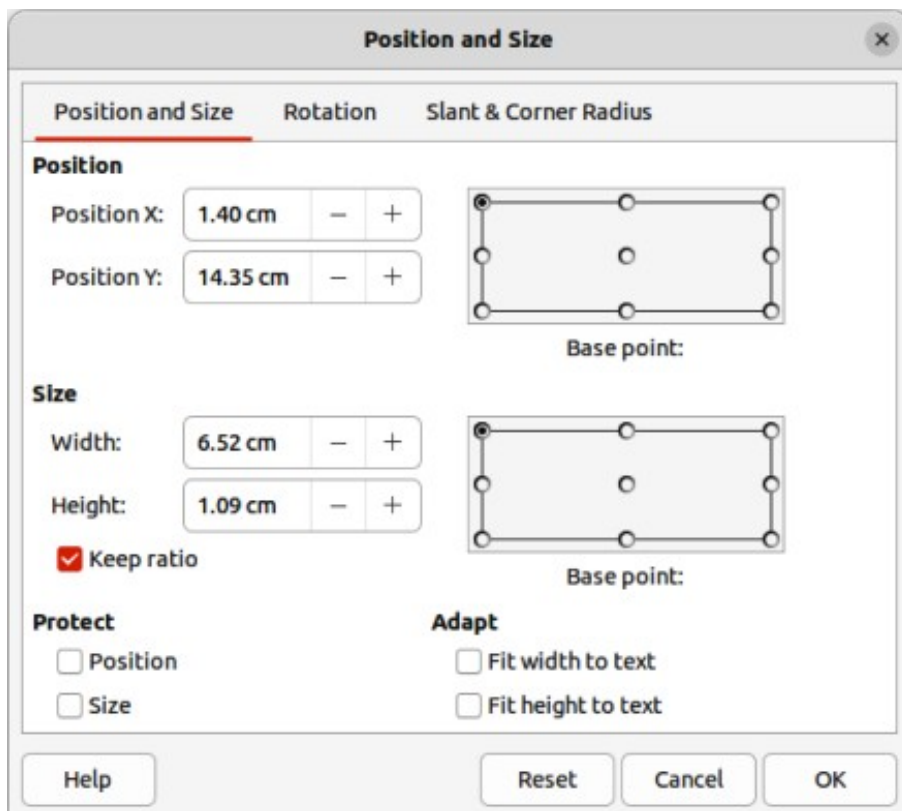

Figure 243: Position and Size dialog

Table position and size

Tables are placed into boxes when created allowing tables to be formatted as a Draw object. After selecting the table, use one of the following methods to change table position and size. See “Text boxes” on page 201 and Chapter 3, Working with Objects for more information positioning and resizing.

- Click on the table border and drag the table to a new position.
- Click and drag on a selection handle to change the table size.
- Open the Position and Size dialog and use the options available on the Position and Size page (Figure 243). The options available in the **Rotation**, and **Slant & Corner Radius** pages cannot be used for a table.

After selecting the table, use one of the following methods to open the Position and Size dialog:

- Right-click on the table and select **Position and Size** from the context menu.
- Go to **Format > Position and Size** on the Menu bar.
- Use the keyboard shortcut *F4*.

Note

When the size of a table box is changed, the table and cell contents also increases or decreases in size to match the box size.

Deleting tables

Whole table

Make sure the table is selected and the selection handles are visible on the table border, then delete the table using one of the following methods:

- Go to **Format > Table > Delete Table** on the Menu bar.
- Select **Delete Table** on the Table toolbar.
- Right-click on the table and select **Delete > Delete Table** from the context menu.

Row or column

Click in a table cell to delete the table row or column using one of the following methods. Make sure the table selection handles are NOT displayed.

- Go to **Format > Table > Delete Row**, or **Delete Column** on the Menu bar
- Select **Delete Row**, or **Delete Column** on the Table toolbar.
- Right-click and select **Delete > Delete Row**, or **Delete Column** from the context menu.

Cell contents

Delete cell contents in a table as follows:

- 1) Select the cell or cells.
- 2) Press the *Delete*, or *Backspace* key on the keyboard.

Using fields

Fields allow for the automatic insertion of text into a drawing and are used when creating templates and drawing masters. For more information on templates and master drawings, see Chapter 11, Advanced Drawing Techniques.

Inserting fields

When a field is created, a text box for the field is inserted into the center of a drawing and can be repositioned just like any other text box. See “Text boxes” on page 201 for more information.

- 1) Go to **Insert > Field** on the Menu bar and select the type of field required.
- 2) If necessary, position and resize the field text box.
- 3) If necessary, format the text used for the field information. See “Formatting text” on page 211 for more information.

Field types

Date (fixed)

Inserts the current date into a drawing as a fixed field. The date is not automatically updated. Available date formats depend on the language setting in **Tools > Options > Language Settings > Language** (macOS LibreOffice > **Preferences > Language Settings > Language**). Right-click on the date field and select the required date format from the context menu.

Date (variable)

Inserts the current date into a drawing as a variable field. The date is automatically updated each time the file is opened. Available date formats depend on the language setting in **Tools > Options > Language Settings > Language** (macOS LibreOffice > **Preferences > Language Settings > Language**). Right-click on the date field and select the required date format from the context menu.

Time (fixed)

Inserts the current time into a drawing as a fixed field. The time is not automatically updated. Available time formats depend on the language setting in **Tools > Options > Language Settings > Language** (macOS LibreOffice > **Preferences > Language Settings > Language**). Right-click on the time field and select the required time format from the context menu.

Time (variable)

Inserts the current time into a drawing as a variable field. The time is automatically updated each time the file is opened. Available time formats depend on the language setting in **Tools > Options > Language Settings > Language** (macOS LibreOffice > **Preferences > Language Settings > Language**). Right-click on the time field and select the required time format from the context menu.

Author

Inserts the first and last names of the author of the drawing. This information is taken from values entered in the LibreOffice user data. To modify this information go to **Tools > Options > LibreOffice > User Data** (macOS LibreOffice > **Preferences > LibreOffice > User Data**).

Page Number

Inserts the page number into the current drawing. Alternatively, go to **Insert > Page Number** on the Menu bar. If a page number is to be added to every page in the drawing, go to **View > Master** on the Menu bar and insert the page number field.

Page Title

Inserts the page title. The default name is *Page #* if the page has not been renamed.

Page Count

Inserts the total number of pages in a drawing.

File Name

Inserts the name of the file used for the drawing. The file name only appears after the file has been saved.

Using hyperlinks

When inserting text that can be used as a hyperlink (for example, a website address or URL), Draw formats it automatically, creates the hyperlink, and applies color and underlining. There are four types of hyperlinks and each hyperlink type requires a different procedure when inserting a hyperlink.

Tips

To prevent LibreOffice from automatically turning website addresses, or URLs into hyperlinks, go to **Tools > AutoCorrect Options > Options** on the Menu bar and deselect **URL Recognition**.

To change the color of hyperlinks, go to **Tools > Options > LibreOffice > Application Colors**, scroll to *Unvisited links* and/or *Visited links*, select the checkboxes, then select new colors from the color palettes for the links and click **OK**. Note this color change changes the color for all hyperlinks across all LibreOffice modules.

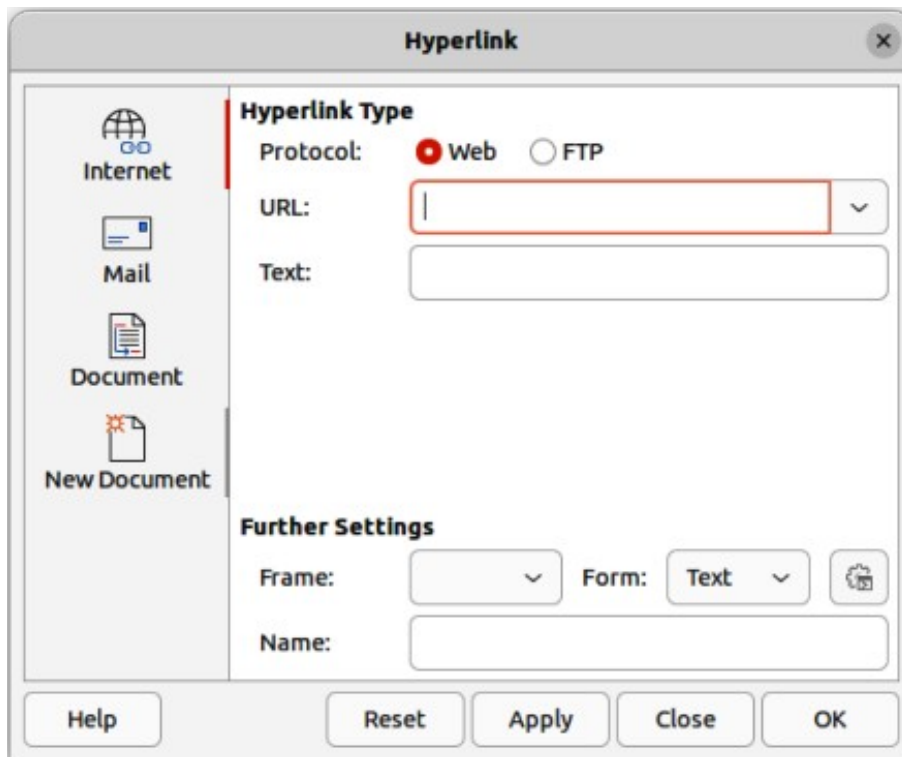

Figure 244: Hyperlink dialog — Internet page

Internet hyperlink

- 1) Click in the text box at the required position for the hyperlink.
- 2) Go to **Insert > Hyperlink** on the Menu bar, or use the keyboard shortcut *Ctrl+K* (macOS *⌘+K*) to open the Hyperlink dialog.
- 3) Select **Internet** to open the **Internet** page of the Hyperlink dialog (Figure 244).
- 4) In **Protocol**, select either *Web*, or *FTP*.
- 5) In the **URL** text box, enter the required web address for the hyperlink.
- 6) In the **Name** text box, enter a name for the hyperlink.
- 7) If necessary, enter the details required for **Further Settings**. See “Further Settings” on page 240 for more information.
- 8) Click **Apply** to insert the hyperlink and save the selections. If several hyperlinks are being created, click **Apply** after inserting each hyperlink.
- 9) Click **OK** to close the Hyperlink dialog.

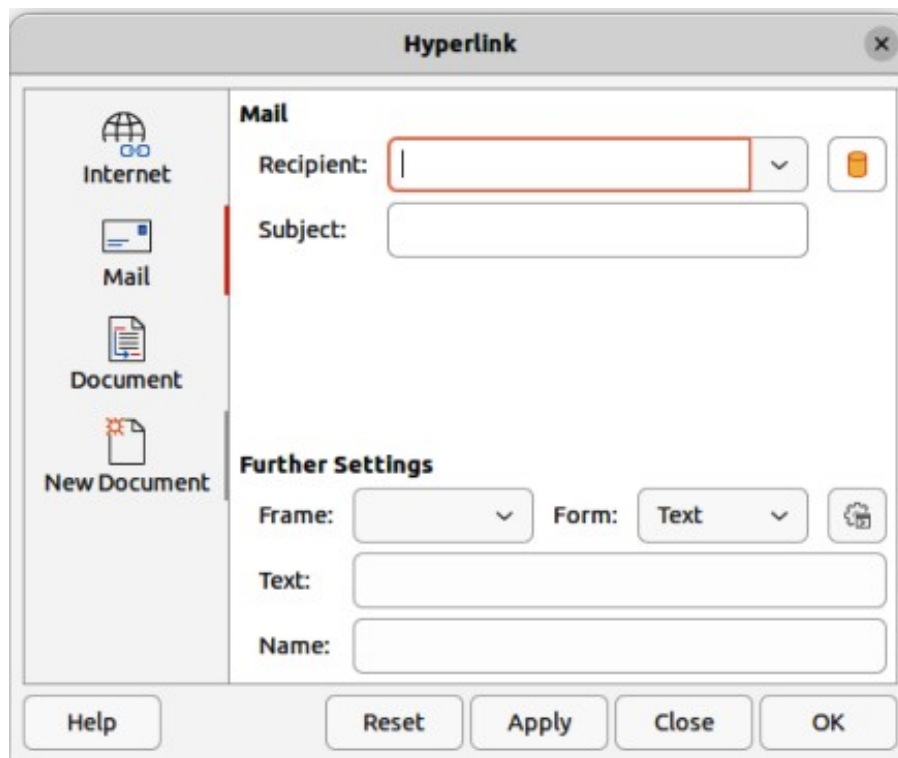

Figure 245: Hyperlink dialog — Mail page

Mail hyperlink

- 1) Click in the text box at the required position for the hyperlink.
- 2) Go to **Insert > Hyperlink** on the Menu bar, or use the keyboard shortcut *Ctrl+K* (macOS *⌘+K*) to open the Hyperlink dialog.
- 3) Select **Mail** to open the **Mail** page of the Hyperlink dialog (Figure 245).
- 4) In **Recipient** text box, enter the email details of the recipient.
- 5) In the **Subject** text box, enter a subject title.
- 6) If necessary, click on **Data Sources** to open a data source browser, then drag the email data field for the receiver from the data source browser into the **Recipient** text box.
- 7) If necessary, enter the details required for **Further Settings**. See “Further Settings” on page 240 for more information.
- 8) Click **Apply** to insert the hyperlink and save the selections. If several hyperlinks are being created, click **Apply** after inserting each hyperlink.
- 9) Click **OK** to close the Hyperlink dialog.

Document hyperlink

Creates a hyperlink to another document or to another place in a document, commonly referred to as a bookmark.

- 1) Click in the text box at the required position for the hyperlink.
- 2) Go to **Insert > Hyperlink** on the Menu bar, or use the keyboard shortcut *Ctrl+K* (macOS *⌘+K*) to open the Hyperlink dialog.
- 3) Select **Document** to open the **Document** page of the Hyperlink dialog (Figure 246).

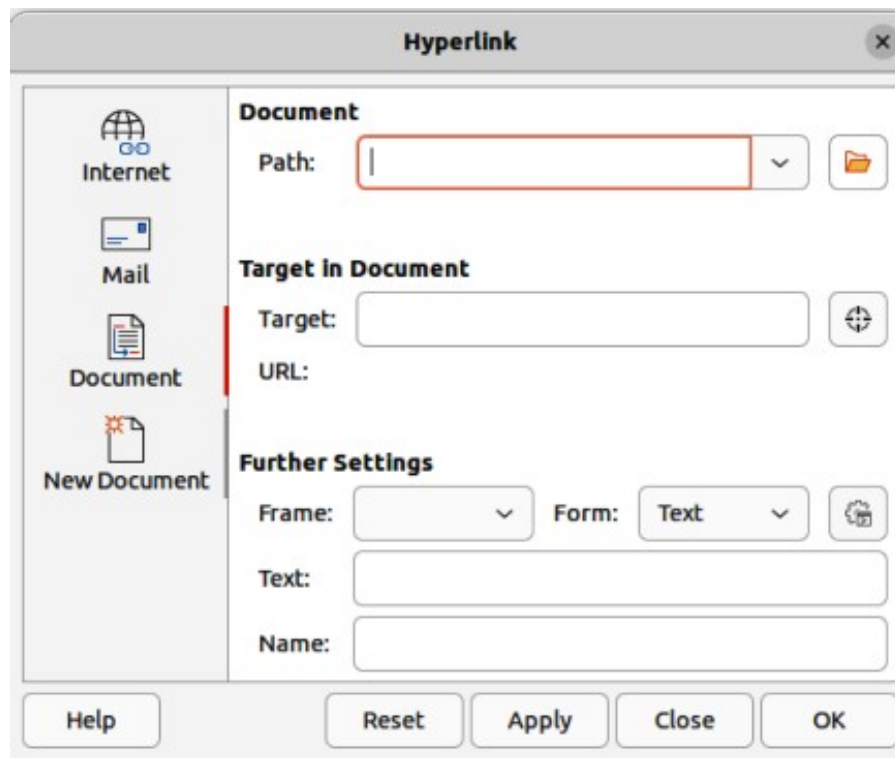

Figure 246: Hyperlink dialog — Document page

✓ Note

Leave **Path** blank if the link is to a target in the same drawing.

- 4) In the **Path** text box, enter the file path for the document.
- 5) Alternatively, click on **Open File** to open a file browser and select the file as a target for the hyperlink.
- 6) Optionally, to specify a target in a specific drawing, click on **Target in Document** to open a dialog to select a target. However, if the name of the target is known, type it into the *Target* text box.
- 7) If necessary, enter the details required for **Further Settings**. See “Further Settings” on page 240 for more information.
- 8) Click **Apply** to insert the hyperlink and save the selections. If several hyperlinks are being created, click **Apply** after inserting each hyperlink.
- 9) Click **OK** to close the Hyperlink dialog.

New Document hyperlink

Creates a new document and a hyperlink to the new document.

- 1) Click in the text box at the required position for the hyperlink.
- 2) Go to **Insert > Hyperlink** on the Menu bar, or use the keyboard shortcut *Ctrl+K* (macOS *⌘+K*) to open the Hyperlink dialog.
- 3) Select **New Document** to open the **New Document** page of the Hyperlink dialog (Figure 247).
- 4) In **New Document** select *Edit now* to edit the newly created document immediately, or *Edit later* to only create the hyperlink.

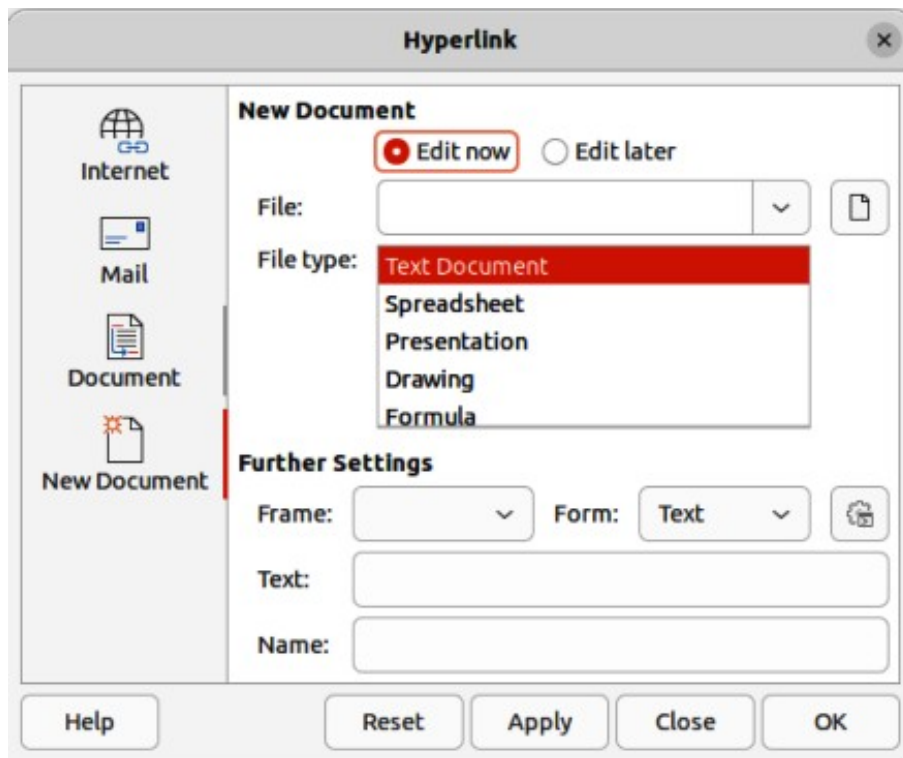

Figure 247: Hyperlink dialog — New Document page

- 5) Select the type of document to create from the **File type** drop-down list.
- 6) Click on **Select path** to open a file browser and navigate to the folder where the new document is going to be saved
- 7) Select the folder and click on **Open**. The selected folder appears in the **File** text box.
- 8) If necessary, enter the details required for **Further Settings**. See “Further Settings” on page 240 for more information.
- 9) Click **Apply** to insert the hyperlink and save the selections. If several hyperlinks are being created, click **Apply** after inserting each hyperlink.
- 10) Click **OK** to close the Hyperlink dialog.

Further Settings

The **Further Settings** section in the Hyperlink dialog is common to all hyperlink types, although some options are more relevant to specific types of links.

Frame

Enter a name for the frame in the **Frame** text box that the linked file opens in, or select a predefined frame from the list. If the **Frame** text box is empty, the linked file opens in the current browser window.

Form

Specifies whether the hyperlink is inserted as text, or as a button.

Text

Specifies the visible text, or button caption for the hyperlink.

Name

Applicable to HTML documents. It specifies the text added as a NAME attribute in the HTML code behind the hyperlink.

Editing text hyperlinks

- 1) Select the hyperlink.
- 2) Right-click on the hyperlink and select **Edit Hyperlink** from the context menu to open the Hyperlink dialog.
- 3) Make editing changes using the available options.
- 4) Click **Apply** to insert the hyperlink and save the selections. If several hyperlinks are being created, click **Apply** after inserting each hyperlink.
- 5) Click **OK** to save the changes and close the Hyperlink dialog.

Note

DO NOT click directly on the hyperlink text when editing or formatting hyperlinks. Clicking on the hyperlink text opens the hyperlink.

Formatting hyperlinks

A hyperlink is inserted in the centre of the current slide. To edit the text, the size of a hyperlink text box, or to reposition the hyperlink on the slide:

- 1) Click and drag a selection marquee over the hyperlink text to display a text box border and selection handles.
- 2) Right-click on the selected hyperlink and select the type of formatting required from the options available in the context menu.
- 3) To reposition hyperlink, click and drag on the text border to move the hyperlink on the slide.
- 4) Select **Position and Size** from the context menu, or use the *F4* key to open the Position and Size dialog. Options can be selected to move the hyperlink, or resize the text box.

Image maps

An image map defines areas of an image (called hotspots) associated with a URL (a web address or a file on the computer). Hotspots are the graphic equivalent of text hyperlinks. In Draw, clicking on a hotspot opens the linked page in the appropriate program (for example, default browser for HTML pages; LibreOffice Writer for ODT files; PDF viewer for PDF files).

Hotspots can be created in various shapes, such as rectangles, ellipses, and polygons, and include several hotspots in the same image. When a hotspot is clicked on, the URL opens in a browser window or frame that has been specified. The text that appears when the cursor hovers over a hotspot can also be specified.

Creating image maps

- 1) Select an image in a drawing to use as a hotspot.
- 2) Go to **Tools > ImageMap** on the Menu bar to open the Image Map Editor dialog (Figure 248). The main part of the dialog shows the selected image where hotspots will be defined.
- 3) Select the type of hotspot area required from the icons at the top of the Image Map Editor dialog from the options **Rectangle**, **Ellipse**, **Polygon**, or **Freeform Polygon**.
- 4) Draw the hotspot area onto the selected image.

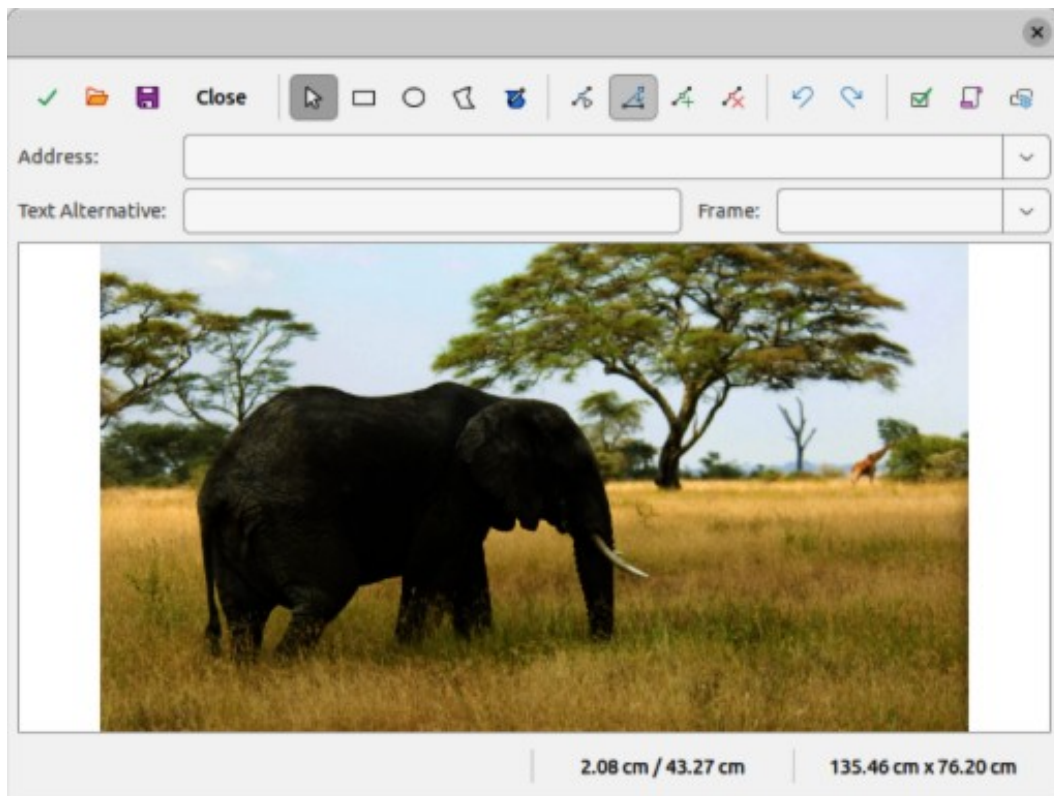

Figure 248: Image Map Editor dialog

- 5) Enter the hyperlink address for the hotspot in the **Address** text box using the address format: `file:///<path>/document_name#anchor_name`.
- 6) Click on **Apply** to apply the settings.
- 7) Click on **Save** to save the image map to a file.
- 8) Click on **Close** the Image Map Editor dialog.

Image map tools

Apply

Applies the changes.

Open

Loads into the Image Map Editor an existing image map in the MAP-CERN, MAP-NCSA or SIP StarView image map file format.

Save

Saves the image map in the MAP-CERN, MAP-NCSA, or SIP StarView image map file format.

Select

Selects a hotspot in the image map for editing.

Rectangle, Ellipse, Polygon, Freeform Polygon

Draws a hotspot on the selected image in the shape selected.

Edit Points

Change the shape of the selected hotspot by editing the anchor points.

Move Points

Move the individual anchor points of the selected hotspot.

Insert Points

Adds an anchor point at the selected point on the outline of the hotspot.

Delete Points

Deletes a selected anchor point.

Undo

Cancels the previous action.

Redo

Reapplies the previous cancelled action.

Active

Toggles the status of a selected hotspot between active and inactive.

Macro

Assign a macro that runs when the hotspot is clicked on.

Properties

Define the properties of the selected hotspot.

Address

Enter the URL for the file that opens when the selected hotspot is clicked on. The address format to be used: `file:///<path>/document_name#anchor_name`.

Text

Enter the text that is displayed when the cursor rests on the hotspot. If no text is entered, the Address is displayed.

Frame

Enter the name of the target frame for the hotspot. Standard frame name can be selected from the drop-down list and used instead.

_blank

Opens in a new browser window.

_self

Default selection and opens in the current window.

_top

File opens in the topmost frame in the hierarchy.

_parent

File opens in the parent frame of the current frame. If there is no parent frame, the current frame is used.

Graphic view

Displays the image map so that the hotspots can be selected and edited.

 **Note**

The value *_self* for the target frame will work on the vast majority of the occasions. It is not recommended to use the other values, if available, unless absolutely necessary.

Fontwork

Using Fontwork creates graphical text as objects in a drawing. Different settings for Fontwork (line, area, position, size, and more) are available to match the requirements of a drawing.

Fontwork is also available with the Writer, Calc, and Impress modules of LibreOffice, but there are small differences in the way that each LibreOffice module displays Fontwork.



Figure 249: Fontwork Gallery dialog



Figure 250: Example of creating Fontwork text

Creating Fontwork

- 1) Go to **Insert > Fontwork** on the Menu bar to open the Fontwork Gallery dialog (Figure 249).
- 2) Select a Fontwork style from the dialog.
- 3) Double click on the selected Fontwork object, or select **OK**. This closes the Fontwork Gallery dialog and the selected Fontwork object appears in the center of the drawing.
- 4) Double-click on the Fontwork object to switch on editing mode. The Fontwork text appears in the center of the image in text edit mode, as shown by the example in Figure 250.

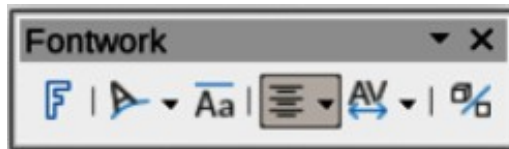

Figure 251: Fontwork toolbar



Figure 252: Fontwork Shape sub-toolbar

- 5) Highlight all of the black text to select, then type in the required text. to replace the highlighted black text.
- 6) Press the *Esc* key, or click outside the selected area to apply the change and the text appears as a Fontwork object in the center of the drawing.
- 7) If necessary reposition and resize the Fontwork object to the drawing requirements. See Chapter 3, Working With Objects and Chapter 4, Changing Object Attributes for more information.

Fontwork toolbar

The Fontwork toolbar (Figure 251) becomes visible and active on the Workspace when a Fontwork object is selected. If the toolbar is not visible, go to **View > Toolbars > Fontwork** on the Menu bar. The following tools are available for editing a Fontwork object.

Insert Fontwork Text

Opens the Fontwork Gallery dialog.

Fontwork Shape

Changes the shape of the selected object. Click on **Fontwork Shape** to open a pop-up toolbar and select a Fontwork shape for the available options. The shapes are shown in the Fontwork Shape floating sub-toolbar (Figure 252).

Fontwork Same Letter Heights

Changes the height of characters in the selected Fontwork object. Toggles between normal height where the characters have different heights to where all characters have the same height.

Fontwork Alignment

Specifies the text alignment within the frame. Options available are *Left Align*, *Center*, *Right Align*, *Word Justify*, and *Stretch Justify*.

Fontwork Character Spacing

Selects the spacing between characters and whether kerning pairs should be used. Options available are *Very Tight*, *Tight*, *Normal*, *Loose*, *Very Loose*, and *Custom*. For *Custom* spacing, input a percentage value: 100% is normal character spacing, less than 100% character spacing is tighter, and more than 100% character spacing is looser.

Toggle Extrusion

Converts the Fontwork object into a 3D shape using extrusion. See Chapter 7, 3D Objects for more information.

Modifying Fontwork

A Fontwork object is treated like any other object in Draw. It can be resized, rotated, skewed, slanted, flipped, and so on. For more information on modifying a Fontwork object, see Chapter 3, Working With Objects, Chapter 4, Changing Object Attributes, and Chapter 5, Combining Multiple Objects.

Fontwork consists of text, but only minimal text formatting options can be used with Fontwork text, for example font type, font size, **Bold**, or *Italic*.

Some of Fontwork shapes can be modified and this is indicated by a dot appearing on a selected shape. For example, change angles of a trapezoid, or parallelogram basic shapes by moving the dot displayed along with the selection handles.



LibreOffice
Community



Draw Guide 7.5

Chapter 10, Printing, Exporting and Emailing

Introduction

The procedures for printing, exporting and emailing drawings from LibreOffice Draw are examples only. Actual procedures do depend on the following:

- Type of computer.
- Computer operating system and software application being used.
- Type of printer connected to the computer.
- How the printer is connected to the computer.

✓ Note

Due to the several ways a computer can be setup, the print dialog that opens may differ from the dialogs shown in this chapter.

Default printer setup

Before printing any drawings from LibreOffice Draw, it is recommended to setup a default printer. An example printer setup procedure for LibreOffice Draw is as follows:

- 1) Go to **File > Printer Settings** on the Menu bar to open the Printer Setup dialog. An example Printer Setup dialog is shown in Figure 253.
- 2) Select the required printer from the printers listed in the *Name* drop-down list.
- 3) If necessary, click on **Properties** in the Printer Setup dialog to open a properties dialog for the selected printer and select the options required for paper and the printer.
- 4) Click **OK** to save the printer selection and close the Printer Setup dialog.

Quick printing

To quickly print a document or drawing, without changing any print settings that are already selected, click on **Print Directly** on the Standard toolbar (Figure 254). **Print Directly** sends the entire document to the default printer defined for the computer. If **Print Directly** is not visible on the Standard toolbar, it is added to the toolbar as follows:

- 1) Right-click in an empty area on the Standard toolbar and select **Visible Buttons** from the context menu.

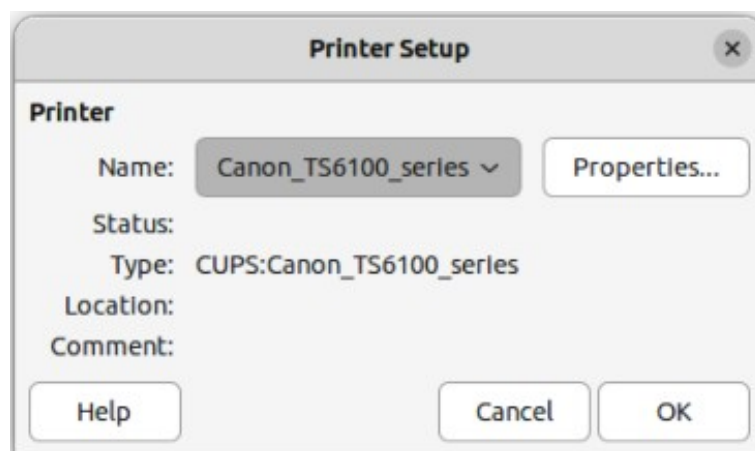

Figure 253: Example of Printer Setup dialog

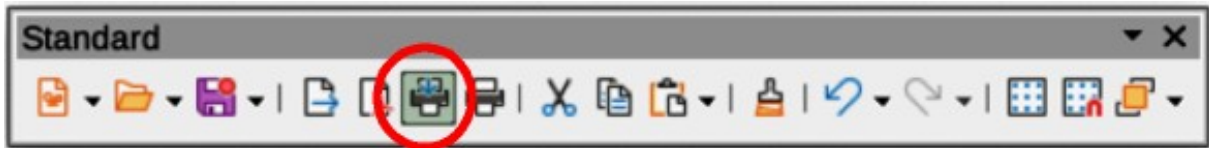

Figure 254: Standard toolbar with Print Directly installed

- 2) Select **Print Directly** from the list of available tools and the **Print Directly** tool is added to the Standard toolbar (highlighted in Figure 254).

✓ Notes

The options selected in the Print dialog only apply to the printing of the current document open in Draw. To specify default print settings for LibreOffice, go to **Tools > Options > LibreOffice > Print** (macOS **LibreOffice > Preferences > LibreOffice > Print**) on the Menu bar to open the Options LibreOffice Print dialog.

Any print options selected in the Print dialog when printing from Draw overrides the default printer settings that have been set using **Tools > Options > LibreOffice > Print** (macOS **LibreOffice > Preferences > LibreOffice > Print**) and **Tools > Options > LibreOffice Draw > Print** (macOS **LibreOffice > Preferences > LibreOffice Draw > Print**).

Linux or Windows printing

For more control over printing when using Linux or Windows operating system, open the Print dialog (Figure 255) using one of the following methods.

- Go to **File > Print** on the Menu bar.
- Use the keyboard shortcut *Ctrl+P*.
- Click on **Print** on the Standard toolbar.

General options

The following options are an example of what may be available on the **General** page of the Print dialog in Windows/Linux (Figure 255).

Printer

Select the printer to use from the printers available in the drop-down list.

Status:

Indicates if the selected printer is the default printer.

Properties

Click on **Properties** to open the properties dialog for the printer being used. The options available in this dialog depends on the type of printer connected to the computer and the computer operating system being used.

Range and Copies

All Pages

Prints all the pages in the document.

Selection

Prints the pages selected in LibreOffice Draw.

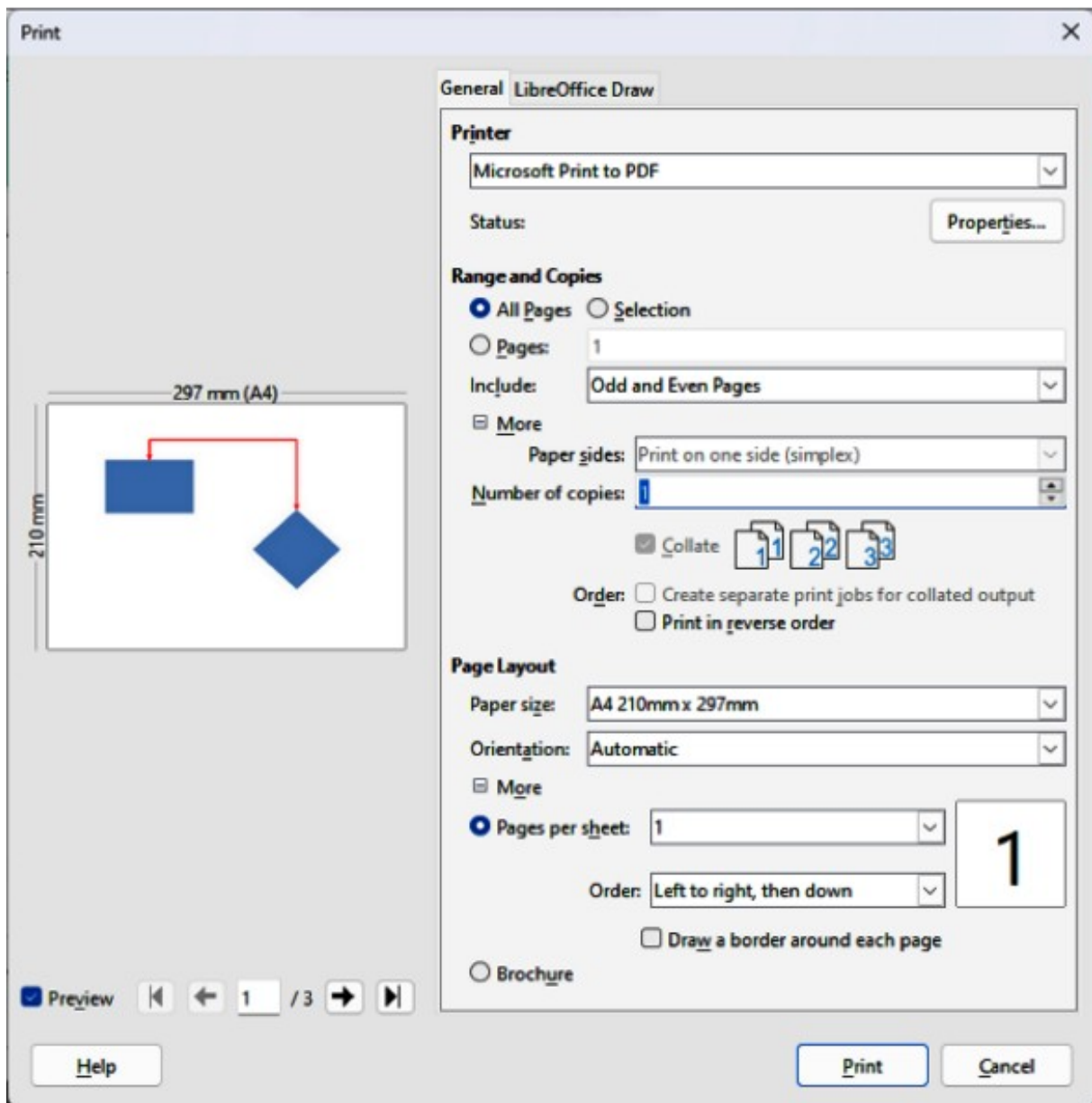

Figure 255: Example of Print dialog — General page — Windows/Linux

Pages

Select the page number(s) to print. For multiple pages, use the format 1, 3, 7 or 1 – 5, 7, 9 for page number selection.

Include

Select from the drop-down list *Odd and Even Pages*, *Odd Pages*, or *Even Pages*.

More > Paper sides

Select from the drop-down list *Print on one side (simplex)*, *Print on both sides (duplex long edge)*, or *Print on both sides (duplex short edge)*.

More > Number of copies

Enter number of printed copies required for the document.

More > Collate

Collates multiple printed copies into separate documents.

More > Order

Select from *Create separate print jobs for collated output* (only available when more than one copy is being printed), or *Print reverse order*.

Page Layout

Paper size

Select the paper size to use from drop-down list.

Orientation

Select from the drop-down list *Automatic*, *Portrait*, or *Landscape*.

More > Pages per sheet

Select from the drop-down list how many pages are printed on one sheet of paper.

More > Order

Select from the drop-down list the printing order of multiple pages on one sheet of paper.

More > Draw a border around each page

When multiple pages are printed on one sheet of paper, a border is drawn around each page.

More > Brochure

Prints the document so the pages can be folded into a brochure or booklet.

LibreOffice Draw options

The following options are an example of what may be available on the **LibreOffice Draw** page of the Print dialog in Windows/Linux (Figure 256) for the current drawing being printed:

Contents

When selected prints the *Page name* and/or *Date and time* on the drawing.

Color

Prints the drawing in *Original colors*, *Grayscale*, or *Black & white*.

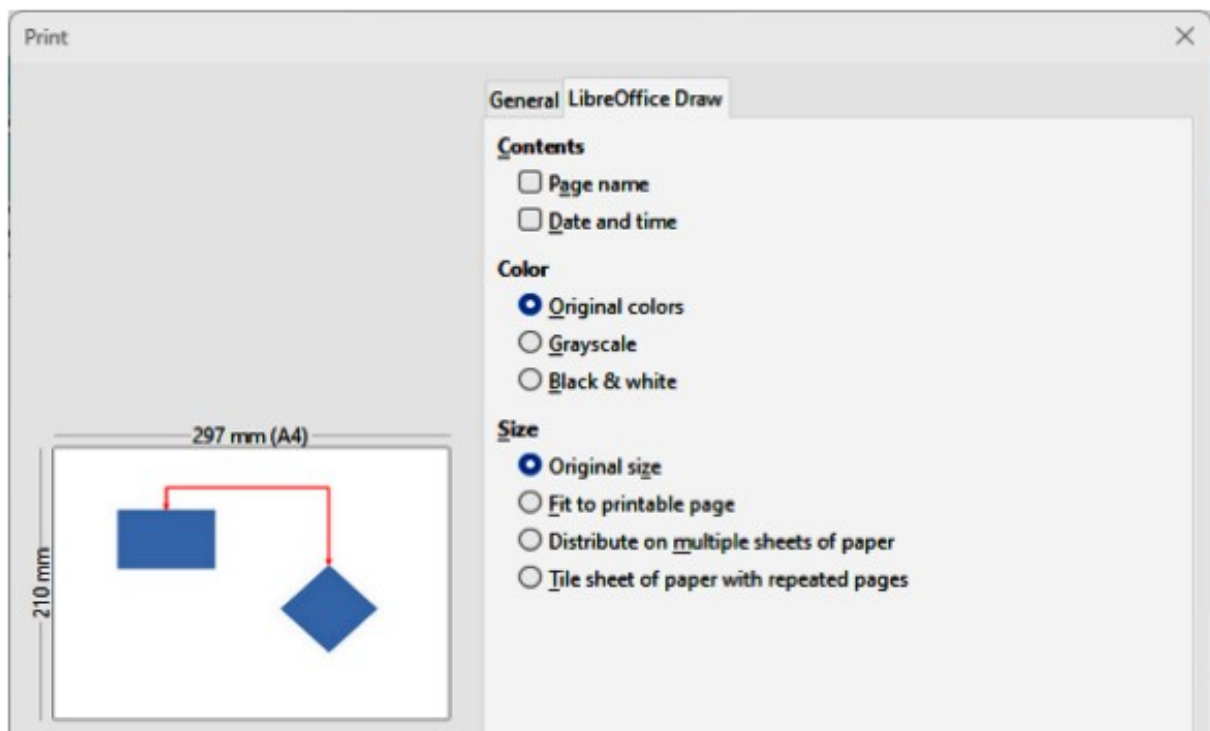

Figure 256: Example of Print dialog — LibreOffice Draw page — Windows/Linux

Size

Print the drawing using one of the following options:

Original size

Prints the drawing using its original size.

Fit to printable page

Drawing size is changed so that it fits on the paper size used for printing.

Distribute on multiple sheets of paper

Used if the drawing is too large for the paper size being used.

Tile sheet of paper with repeated pages

Used to print multiple copies of a drawing on a page.

macOS printing

For more control over printing using macOS, open and use the Print dialog (Figure 257) using one of the following methods.

- Go to **File > Print** on the Menu bar.
- Use the keyboard shortcut **⌘+P**.
- Click on **Print** on the Standard toolbar.

General printing options

The following options are an example of what may be available on the **General** page of the Print dialog in macOS (Figure 257).

Printer

Select the printer to be used from the drop-down list. If the default printer is being used, then this printer will already be selected.

Presets

Select from the drop-down list a printing preset. The presets available depend on the type of printer connected to the computer. This also includes any custom presets that have been created.

Copies

Enter the number of copies to be printed.

Pages

All

Prints all the pages in the document.

Range from

Select a range of page number(s) to print.

Selection

Select the pages to print from the **Pages** pane.

Print in Color

Select this option to print the drawing in color if the printer selected is capable of color printing. Deselect this option to print the drawing in monochrome.

Double-sided

Select this option to print the drawing double sided if the printer selected is capable of double sided printing.

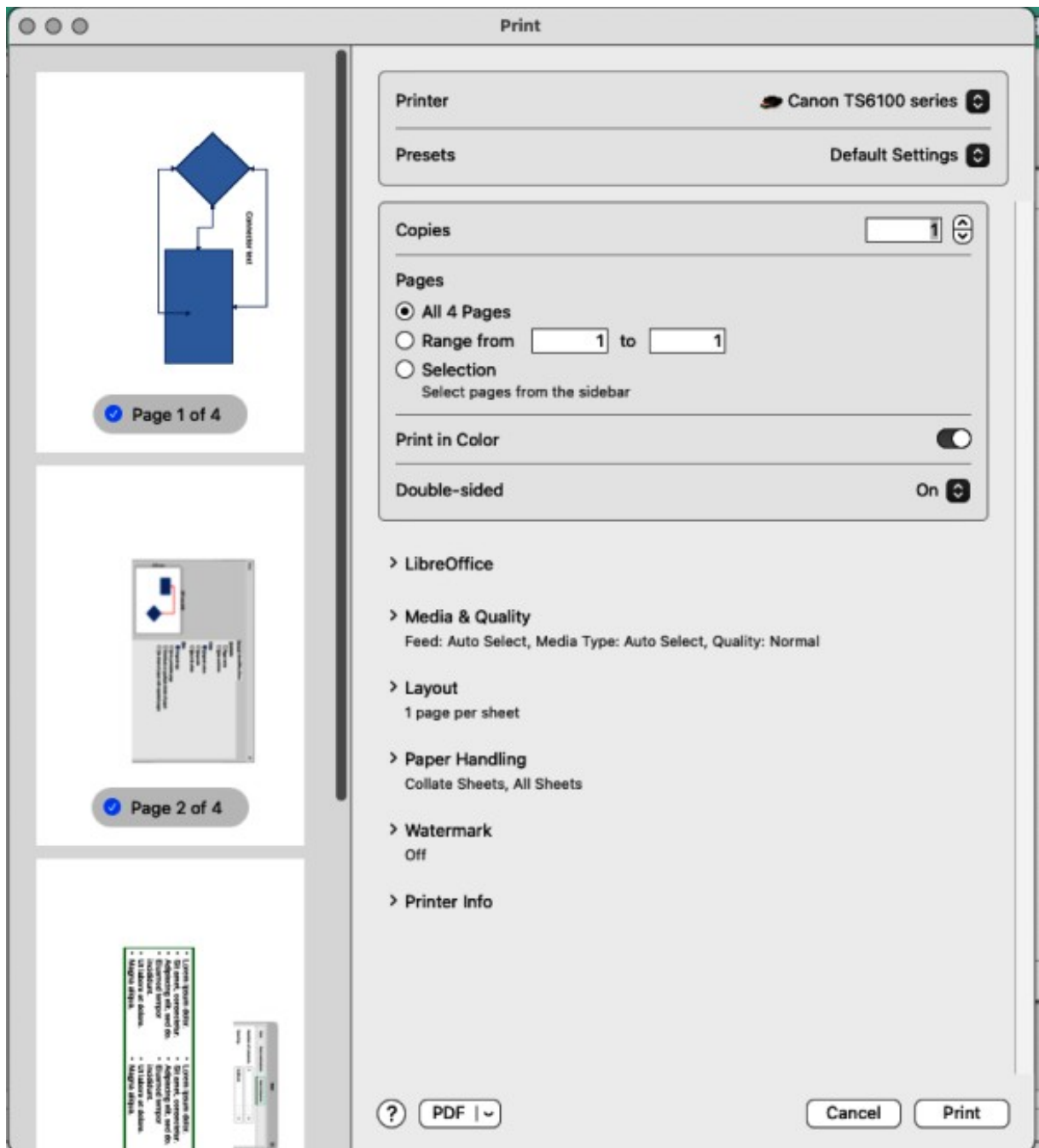

Figure 257: Example of Print dialog — General page — macOS

On

When selected, prints the drawing pages double-sided using long edge binding.

On (Short)

When selected, prints the drawing pages double-sided using short edge binding.

Media & Quality

Click on this option to open a drop-list down with the following options for media and quality.

Feed from

Select from the drop-down list the paper tray to use if the printer has more than one paper tray.

Media Type

Select from the drop-down list the paper type that has been loaded into the paper tray being used, for example Envelope, Photo, Plain Paper.

Quality

Select the level of printing quality required.

Layout

Click on this option to open a drop-list down with the following options for the document printing layout.

Pages per sheet

Select from the drop-down list how many pages are printed on one sheet of paper.

Layout Direction

Select the printing order of multiple pages on one sheet of paper.

Border

When multiple pages are printed on one sheet of paper, a border is drawn around each page.

Reverse page orientation

If LibreOffice prints the pages in the wrong order, select this option and print the document again.

Flip horizontally

If LibreOffice prints the pages in the wrong orientation, select this option and print the document again.

Paper Handling

Click on this option to open a drop-list with the following options for paper handling when printing multiple page documents.

Collate Sheets

When selected collates multiple printed copies into separate documents.

Pages to Print

Select which pages in the document to print from the drop-down list: *All pages*; *Odd only*; *Even only*.

Page Order

Select the page printing order from the drop-down list: *Automatic*; *Normal*; *Reverse*.

Scale to fit paper size

Adjusts the printed page to fit the paper size.

Destination Paper Size

Select a paper size from the options available in the drop-down list. Only available if Scale to fit paper size has been selected.

Scale Down Only

Scales down the drawing to fit the page size. Only available if the selected page size is smaller than the drawing size.

Watermark

Provides options to print watermark text on the drawing pages, for example *Confidential* if the document is of a sensitive nature.

LibreOffice Draw printing

Click on LibreOffice to open the printing options available for LibreOffice Draw (Figure 258).

Print selection only

Prints the selected pages in **Pages** pane.

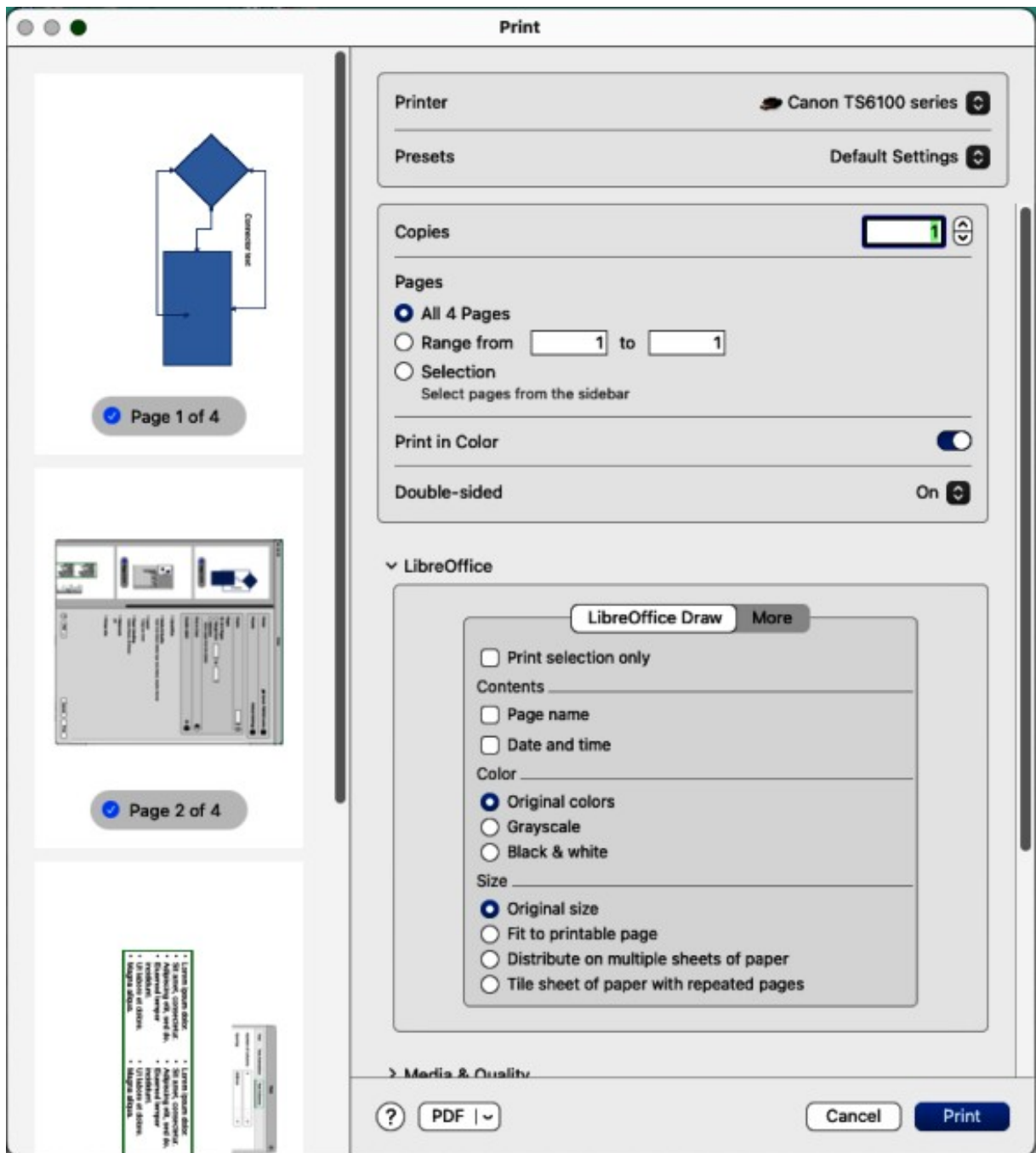

Figure 258: Example of Print dialog — LibreOffice Draw page — macOS

Contents

Prints the *Page name* and/or *Date and time* on the drawing.

Color

Prints the drawing in *Original colors*, *Grayscale*, or *Black & white*.

Size

Prints the drawing using one of the following options:

Original size

Prints the drawing using its original size.

Fit to printable page

Drawing size is changed so that it fits on the paper size used for printing.

Distribute on multiple sheets of paper

Used if the drawing is too large for the paper size being used.

Tile sheet of paper with repeated pages

Used to print multiple copies of a drawing on a page.

LibreOffice Draw More options

To access more printing options in LibreOffice Draw, click on **More** to open the **More** page for more LibreOffice Draw options (Figure 259).

Brochure

When selected, prints the document so the pages can be folded into a brochure or booklet.

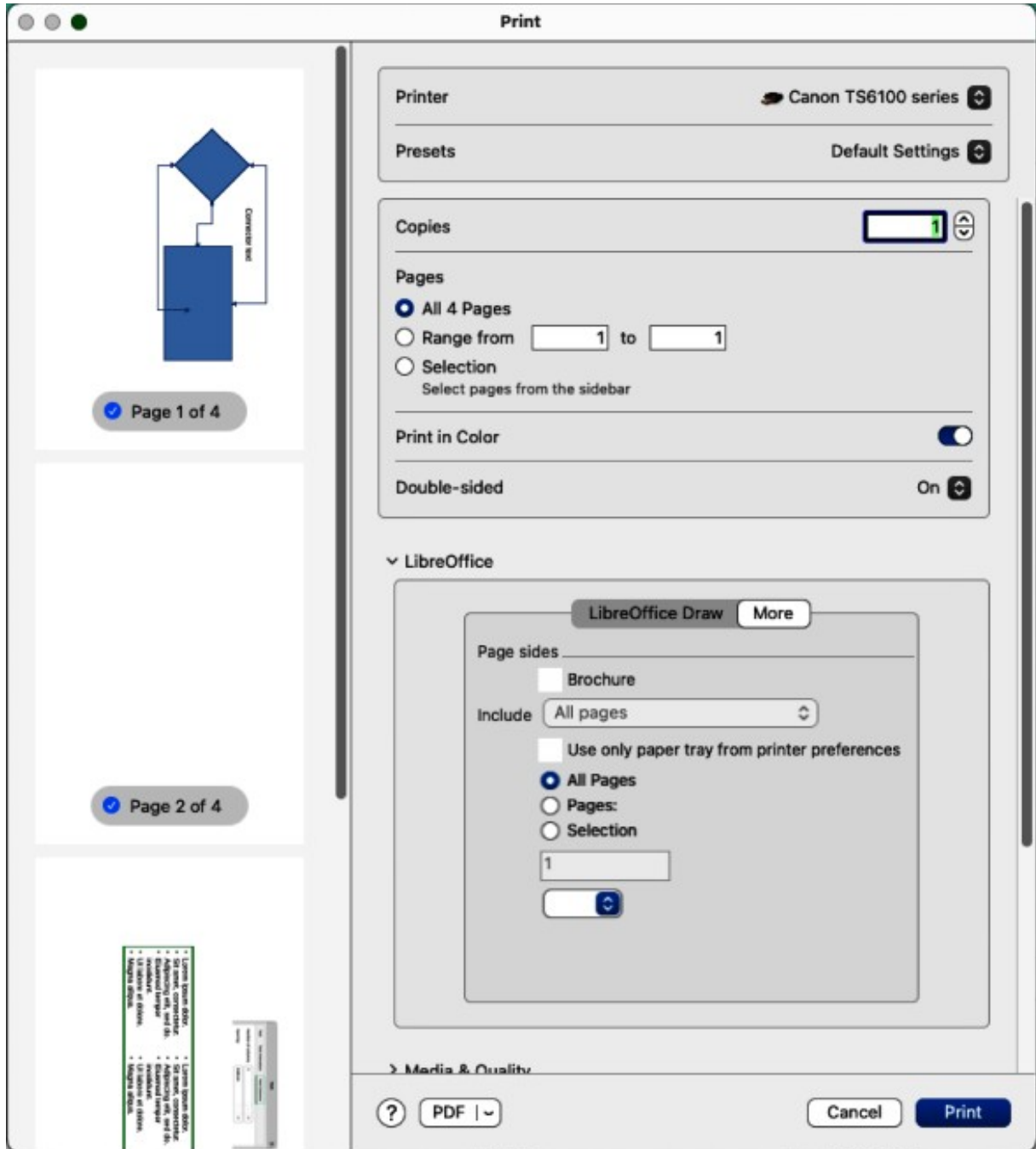

Figure 259: Example of Print dialog — LibreOffice Draw More page — macOS

Include

Select which pages to print from the drop-down list: *All pages*; *Front sides/right pages*; *Back sides/left pages*. Only available when **Brochure** is selected.

Use only paper tray from printer preferences

When selected, the printer tray selected on the printer overrides the selected tray in the printer properties on the computer.

All Pages

All the slides in the slide show are printed.

Pages

Enter the page number(s) in the text box that are to be printed. For multiple pages, use the format 1, 3, 7 or 1 — 5, 7, 9 for page number selection.

Selection

Prints the pages selected in the **Pages** pane.

Printing examples

The following printing instructions are examples only. Actual printing method may differ from these examples because printing depends on computer operating system, computer setup, and the printer being used. For more information on printing, see “Linux or Windows printing” on page 249, or “macOS printing” on page 252, and see the *Writer Guide*.

Multiple pages on a single sheet

- 1) Open the Print dialog.
- 2) Select the printer to use if more than one printer is connected to the computer.
- 3) In **Page Layout**, select the number of pages to print per sheet of paper from the *Pages per sheet* drop-down list. The preview panel on the right shows how the pages will look on a printed sheet of paper.
- 4) In **Page Layout**, select how the multiple pages are printed on the sheet of paper from the *Order* drop-down list.
- 5) If necessary, select *Draw a border around each page* to distinguish each page printed on a sheet of paper.
- 6) Click **OK** to print the document and close the Print dialog.

Individual page

- 1) Open the Print dialog,.
- 2) Select the printer to use if more than one printer is connected to the computer.
- 3) In **Ranges and Copies**, select *Pages* and enter the page number of the page to print.
- 4) Click **OK** to print the individual pages and close the Print dialog.

Range of pages

- 1) Open the Print dialog.
- 2) Select the printer to use if more than one printer is connected to the computer.
- 3) In **Ranges and Copies**, select *Pages* and enter the page numbers of the pages to print using the format, for example, 1,3,7 or 2–5,7,9 for page number selection.
- 4) Click **OK** to print the pages and close the Print dialog.

Selection printing

- 1) Select the pages in the **Pages** panel in LibreOffice Draw.
- 2) Open the Print dialog.
- 3) Select the printer to use if more than one printer is connected to the computer.
- 4) In **Ranges and Copies**, select *Selection* and then select *Odd and Even Pages*, *Even Pages*, or *Odd Pages* from the drop-down list.
- 5) Click **OK** to print the pages and close the Print dialog.

Brochure printing

In Writer, Impress, and Draw, a document can be printed as a brochure (also known as booklet printing). The pages are arranged so that when the printed pages are folded in half, the pages are in the correct order to form a brochure or booklet.

Tip

Plan the document to make it look good when printed as a brochure. Choose appropriate margins, font sizes, and so on as the pages are normally printed at half size on a sheet of paper. Experiment to get the best document format to match the capabilities of the printer being used.

Simplex printer

- 1) Open the Print dialog.
- 2) Select the printer to use if more than one printer is connected to the computer.
- 3) In **Printer**, click *Properties* to open the properties dialog for the selected printer.
- 4) Make sure the printer is set to the same orientation (portrait or landscape) as specified in the page setup for the document. Usually the orientation does not matter, but it does for brochures.
- 5) Click **OK** to close the properties dialog and return to the Print dialog.
- 6) In **Page Layout**, select *More*, then select the *Brochure* option.
- 7) In **Range and Copies**, select *Even pages*, or *Odd pages* from the *Selection* drop-down list.
- 8) Click **OK** to print the even or odd pages.
- 9) Take the printed pages out of the printer and put back into the printer in the correct orientation to print on the blank side. This may require some testing to find out what the correct arrangement is for the selected printer.
- 10) If *Even Pages* was selected, now select *Odd Pages* in **Range and Copies**. If *Odd Pages* was selected, now select *Even Pages* in **Range and Copies**.
- 11) Click **OK** to finish printing the document as a brochure and close the Print dialog.
- 12) Make sure the printed pages create a brochure when all the pages are placed in the correct order.

Duplex printer

- 1) Open the Print dialog.
- 2) Select the printer to use if more than one printer is connected to the computer.
- 3) In **Printer**, click *Properties* to open the properties dialog for the selected printer.

- 4) Make sure the printer is set to the same orientation (portrait or landscape) as specified in the page setup for the document. Usually the orientation does not matter, but it does for brochures.
- 5) Click **OK** to close the properties dialog and return to the Print dialog.
- 6) In **Range and Copies**, select **More**, then select *Print on both sides (duplex long edge)* from the *Paper sides* drop-down list. Actual options available for duplex printing depend on the printer model and the computer system being used.
- 7) In **Page Layout**, Select *More*, then select the *Brochure* option.
- 8) In **Range and Copies**, select the *All Pages* option.
- 9) Click **OK** to print the document as a brochure and close the Print dialog.

Black and white or grayscale printing

Printer settings

The following example procedure explains how to print documents in black and white or grayscale on a color printer:

- 1) Open the Print dialog.
- 2) Select the printer to use if more than one printer is connected to the computer.
- 3) Click on **LibreOffice Draw** to open the printing options page for LibreOffice Draw.
- 4) In **Color**, select *Grayscale*, or *Black & white*.
- 5) Click **OK** to print the document and close the Print dialog.

✓ Note

Some color printers may only allow printing in color regardless of the settings selected. More details can be found in the information that came with the selected printer.

i Tip

Grayscale is the best option for printing any colored text or graphics in a document on a monochrome printer. Colors printed in shades of gray give more detail. When printing color in black and white some of this detail maybe lost.

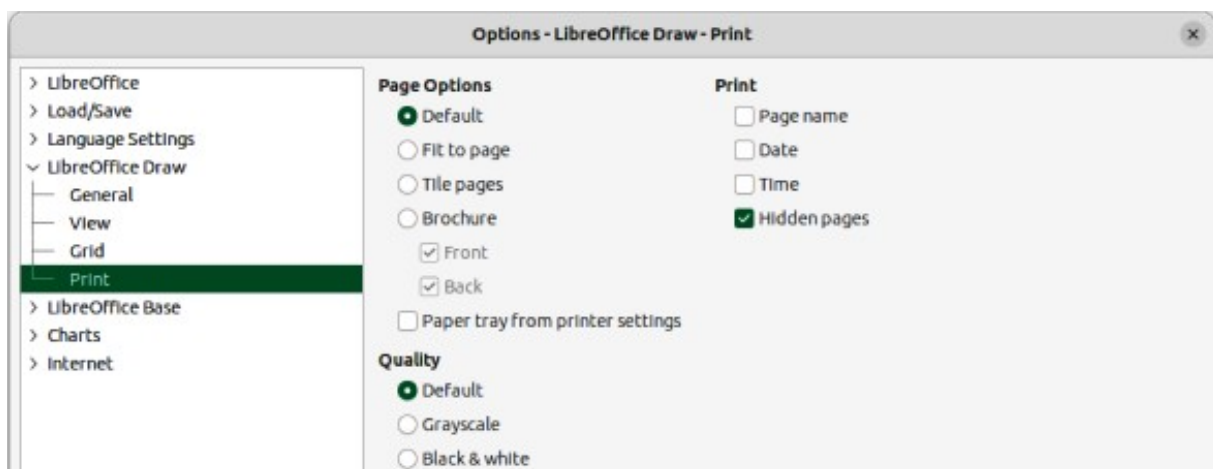

Figure 260: Options LibreOffice Draw Print dialog

LibreOffice settings

To change the LibreOffice settings to print all colored text and graphics as grayscale, or black and white:

- 1) Go to **Tools > Options > LibreOffice Draw > Print** (macOS **LibreOffice > Preferences > LibreOffice Draw > Print**) on the Menu bar to open the Options LibreOffice Draw Print dialog (Figure 260).
- 2) In **Quality**, select either the option *Grayscale*, or *Black & white*.
- 3) Click **OK** to save the change and close the Options LibreOffice Draw Print dialog.
- 4) Print the document using one of the above procedures and the document is printed as grayscale, or black and white.

Exporting

PDF format

LibreOffice can export documents as a PDF (Portable Document Format) file. This commonly accepted standard of file format is ideal for sending a file to be viewed on another computer using PDF viewing software.

Directly as PDF

Export the entire document using default PDF settings as follows:

- 1) Click on **Export Directly as PDF** on the Standard toolbar, or go to **File > Export As > Export Directly as PDF** on the Menu bar.
- 2) Enter a file name and location for the PDF file and click on **Save** to export the file as PDF.



Note

Note that page range, image compression, or other printing options are not available when creating a PDF file using this method.

Controlling PDF content and quality

For more control over the content and quality of the resulting PDF, use the options available in the PDF Options dialog (Figure 261). For more information on available options, see the *Getting Started Guide*.

- 1) Go to **File > Export As > Export as PDF** on the Menu bar to open the PDF Options dialog.
- 2) Select the required options available in the available pages in the PDF Options dialog.
- 3) Click on **Export** and a file browser window opens.
- 4) Navigate to the required location and enter a file name for the PDF being created.
- 5) Click on **Save** to export the file as PDF. The file browser window and the PDF Options dialog close.

Other formats

LibreOffice can export files in various formats, which are listed in the drop-down list of the file browser window. For more information on exporting graphics, see Chapter 6, Editing Pictures.

- 1) Go to **File > Export** on the Menu bar to open a file browser window.
- 2) Navigate to the directory where the drawing is going to be saved.

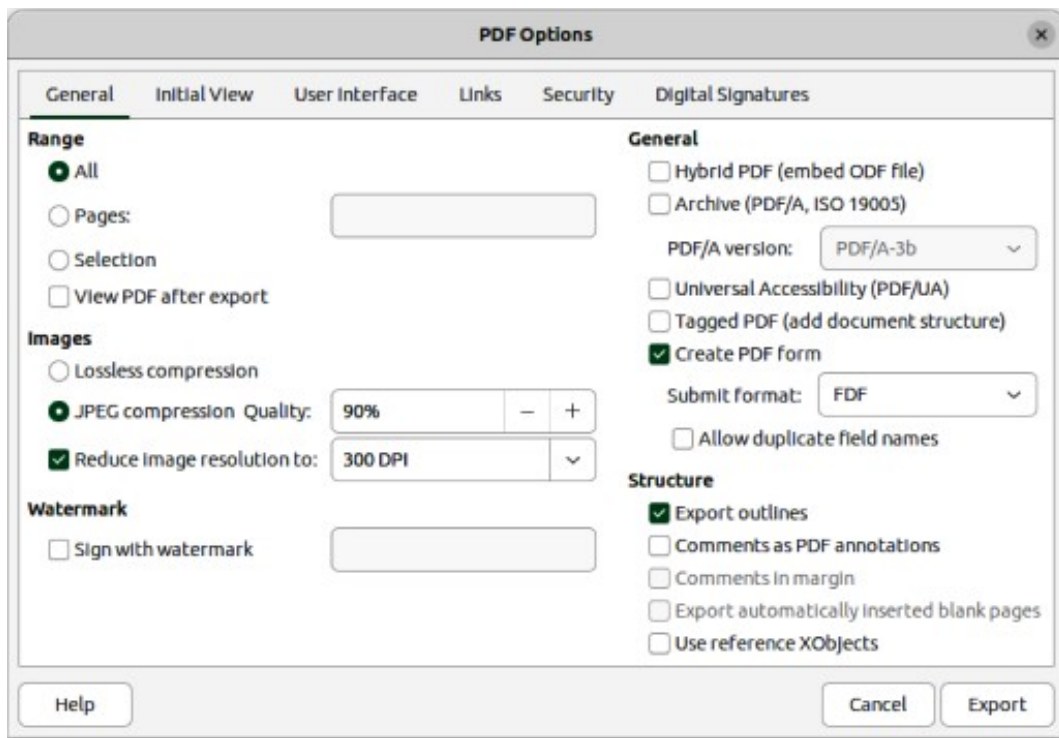

Figure 261: PDF Options dialog — General page

- 3) Specify a file name for the exported drawing in the **Name** text box.
- 4) Select the required file format from the drop-down list.
- 5) Click on **Save** to save the file and close the file browser window.

✓ Note

The content of the exported file depends on the elements selected on the drawing. If no elements are selected, the complete drawing file is exported.

Web pages (HTML) export

Drawing files can be exported as a series of web pages (HTML format) that can be viewed in any browser.

- 1) Make sure the Draw file is open in Draw.
- 2) Create a folder to contain the HTML pages that are generated and this folder will be selected as the destination for the HTML pages.
- 3) Go to **File > Export** on the menu bar to open a file browser window and navigate to the folder where the HTML version of the presentation is going to be saved.
- 4) Enter a name for the HTML file in the *Name* text box at the top of the file browser window.
- 5) At the bottom of the file browser, select *HTML Document (Impress) (.html; .htm)* format from the drop-down list.
- 6) Click on **Save** and the HTML Export dialog opens at the Assign Design page (Figure 262).
- 7) Select a design for all of the HTML pages, either from an existing design, or by creating a new design. If there is no previously saved design available, the *Existing design* option is not available.

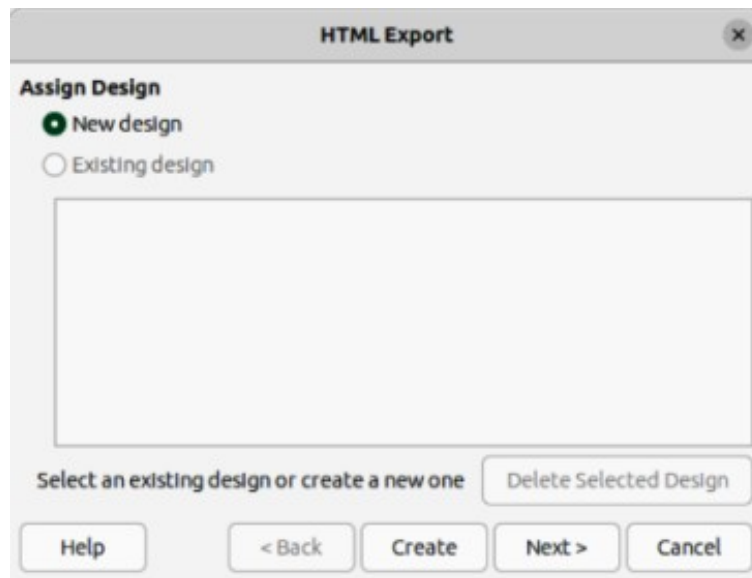

Figure 262: HTML Export dialog — Assign Design page

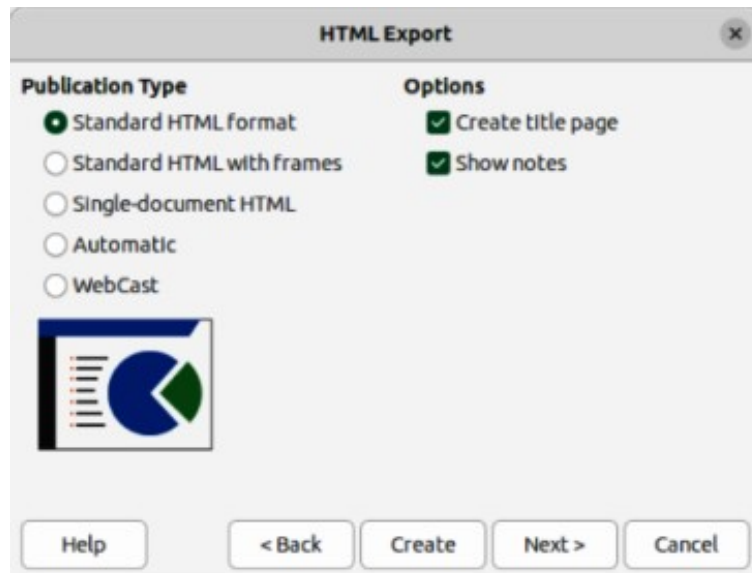

Figure 263: HTML Export dialog — Publication Type page

- 8) Click on **Next** to select the publication type to use for creating the web pages, as shown in Figure 263. The available options change depending on publication type selected.
- **Standard HTML format** — one page for each slide with navigation links to move from slide to slide.
 - **Standard HTML with frames** — one page with a navigation bar on the left-hand side and uses slide title as navigation links. Click on links to display pages in right-hand side.
 - **Single-document HTML** — creates one HTML document from the slide show.
 - **Automatic** — one page for each slide with each page set with the refresh meta tag so a browser automatically cycles from one page to the next.
 - **WebCast** — generates an ASP or Perl application to display the slides. Currently, LibreOffice has no direct support for PHP.

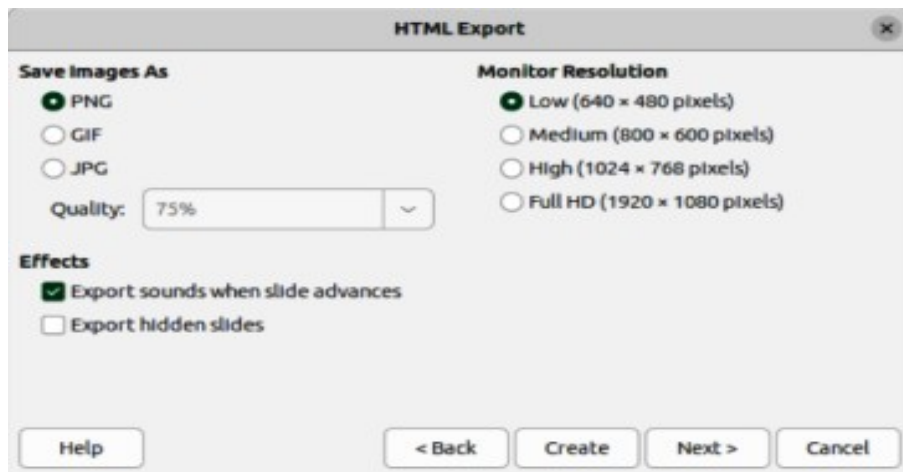

Figure 264: HTML Export dialog — Save Images As page

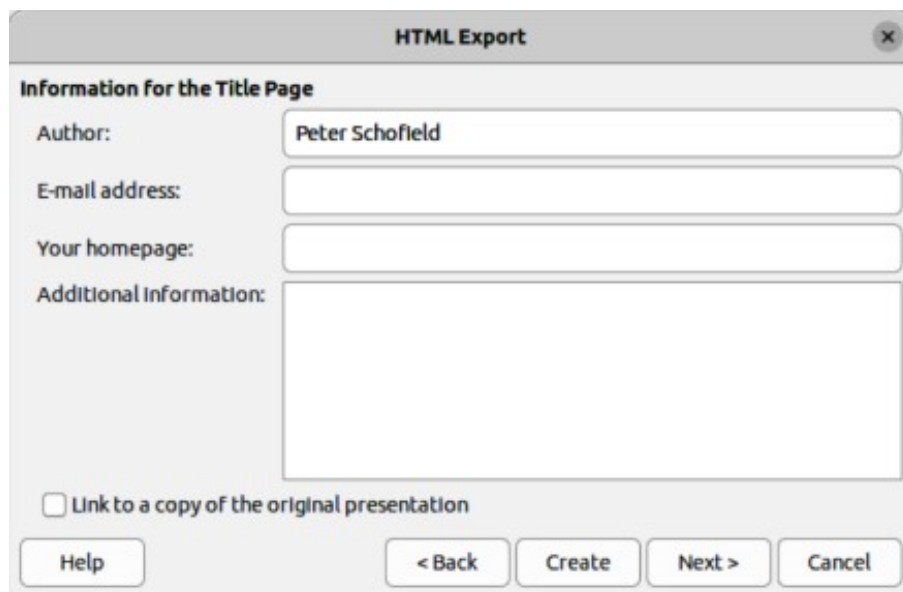

Figure 265: HTML Export dialog — Title page

- 9) Click on **Next** to select the format for saving images (PNG, GIF or JPG) from the options available in **Save Images As** (Figure 264).
- 10) In *Quality*, enter a percentage value for the images being saved. Only available if JPG format has been selected.
- 11) In **Monitor Resolution**, select the type of resolution from the options available. When selecting a monitor resolution, consider what type of display users may have. For example, if high resolution is selected, then users with a medium-resolution display have to scroll sideways to see the entire HTML page.
- 12) In **Effects**, select whether sounds and/or hidden slides are exported.
- 13) Click on **Next** and enter the necessary details for a title page (Figure 265). This page does not display if the *Create title page* option was NOT selected when selecting **Publication Type**.
- 14) Click on **Next** to select the style of navigation buttons to use when moving from one page to another from the options available in **Select Button Style** (Figure 266). If buttons are not being used, make sure *Text only* is selected.

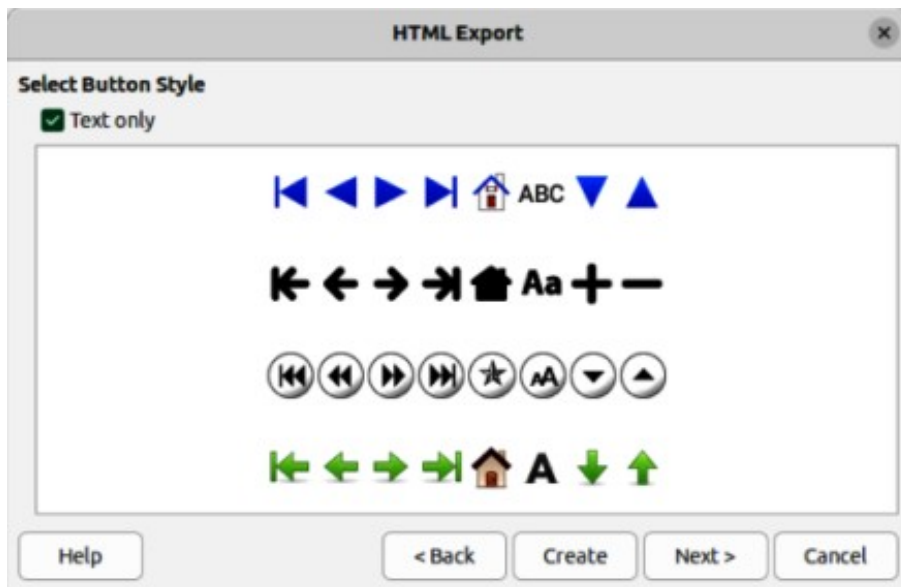

Figure 266: HTML Export dialog — Button Style page

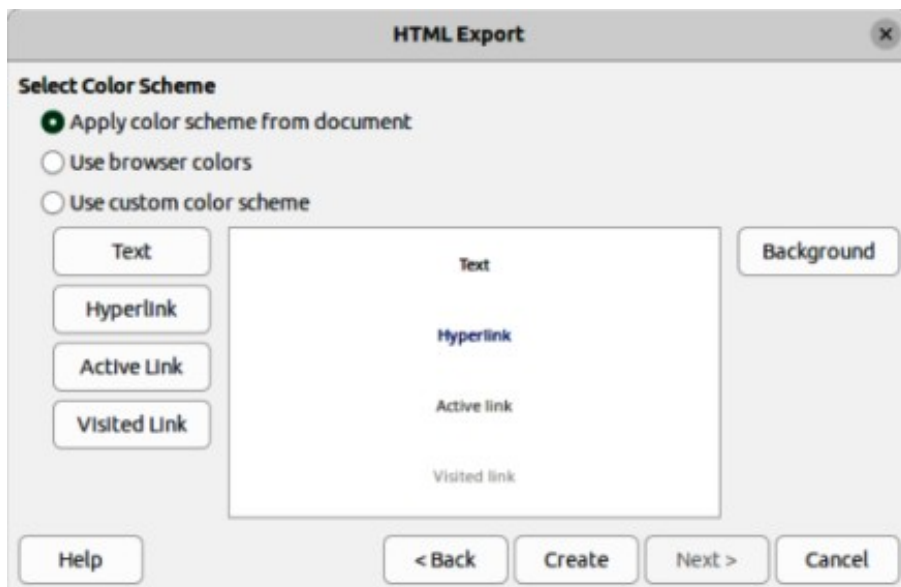

Figure 267: HTML Export dialog — Color Scheme page

- 15) Click on **Next** to select the color scheme for the web pages from the options available in **Select Color Scheme** (Figure 267). Available schemes include the existing scheme for the drawing, one based upon browser colors, and a user-defined scheme. A new scheme can be saved so that it appears on the first page of the HTML export wizard.
- 16) Click on **Create** to generate the HTML files. If this is a new design, a dialog opens to save the design for future use.

Emailing documents

LibreOffice provides several ways to send documents quickly and easily as an email attachment in ODF format (LibreOffice default format), or as a PDF. For more information on emailing documents, see the *Getting Started Guide*.

Open Document format

To email the current document in ODF format:

- 1) Go to **File > Send > Email Document** on the Menu bar. LibreOffice opens the default email program with the document attached to a new email.
- 2) In the email program, enter the recipient, subject, and message, then send the email.

PDF format

To email the current document as a PDF file:

- 1) Go to **File > Send > E-mail as PDF** on the Menu bar. and the PDF Options dialog (Figure 261 on page 261) opens.
- 2) Create a PDF file of the drawing using the options available in the PDF Options dialog, see “PDF format” on page 260 for more information. The default email application opens with the PDF file attached to a new email.
- 3) In the email application, enter the recipient, subject, and message, then send the email.

Digital signatures

A digital signature is a mathematical scheme for verifying the authenticity of digital versions of drawings or documents.

Signing a drawing digitally, a personal key or certificate is required. This personal key, stored on the computer, uses a combination of a private key, which must be kept secret, and a public key. These keys are added to a drawing when a digital signature is applied. A certificate is obtained from a certification authority, which may be a private company or a government institution.

Applying a digital signature to a drawing, a checksum is computed from the drawing content plus the personal key being used. The checksum and public key are stored together with the drawing.

Opening the drawing on another computer with a recent version of LibreOffice, the program computes the checksum again and compares it with the stored checksum. If both checksums are the same, the program opens the original, unchanged drawing.

Also, the program can display the public key information from the certificate. This information is compared with the public key that is published on the web site of the certificate authority. Whenever the drawing is changed, this change breaks the digital signature.

For a more detailed description of how to obtain, use and manage a certificate and signature validation, see the *Getting Started Guide* and **Applying Digital Signatures** in the LibreOffice Help (https://help.libreoffice.org/7.1/en-US/text/shared/guide/digitalsign_send.html?&DbPAR=WRITER&System=UNIX).

Removing personal data

It maybe necessary to remove any personal data, versions, notes, hidden information, or recorded change from drawings before being distributed, or PDFs files created.

Setting security and warning options

- 1) In **Tools > Options > LibreOffice > Security** (macOS **LibreOffice > Preferences > LibreOffice > Security**), to open Options LibreOffice Security dialog (Figure 268).
- 2) Click on **Options** to open the Security Options and Warnings dialog (Figure 269).

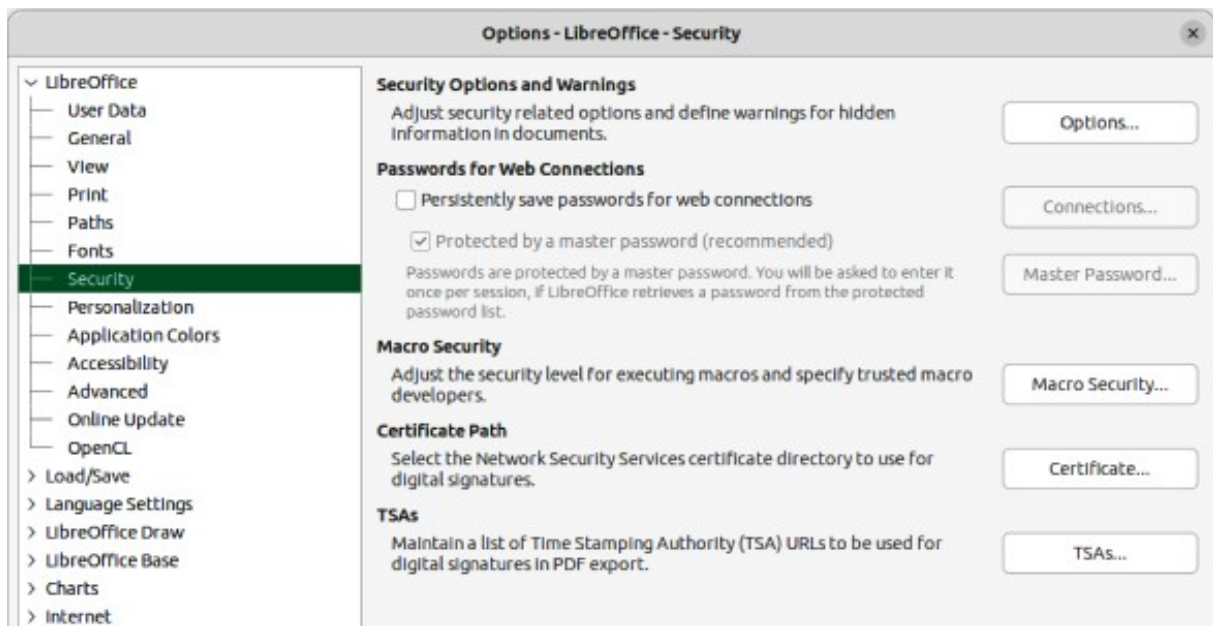

Figure 268: Options LibreOffice Security dialog

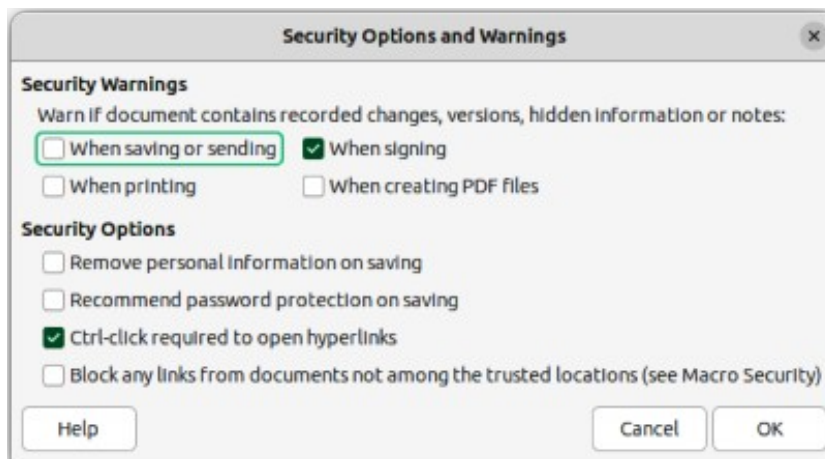

Figure 269: Security Options and Warnings dialog

- 3) Select the required options to allow LibreOffice to warn when drawings contain certain information and/or automatically remove personal information on saving.
- 4) Click **OK** to close the Security Options and Warnings dialog and save the selected options.
- 5) Click **OK** to close the Options LibreOffice Security dialog.

Removing personal data and drawing information

- 1) Open the drawing file and go to **File > Properties** on the Menu bar to open the Properties dialog (Figure 270).
- 2) Make sure the **General** page is selected and deselect the option *Apply user data*.
- 3) Click on *Reset Properties* to change the following file properties:
 - Remove any information in the created and modified fields.
 - Delete the modification and printing dates.
 - Reset the editing time to zero.

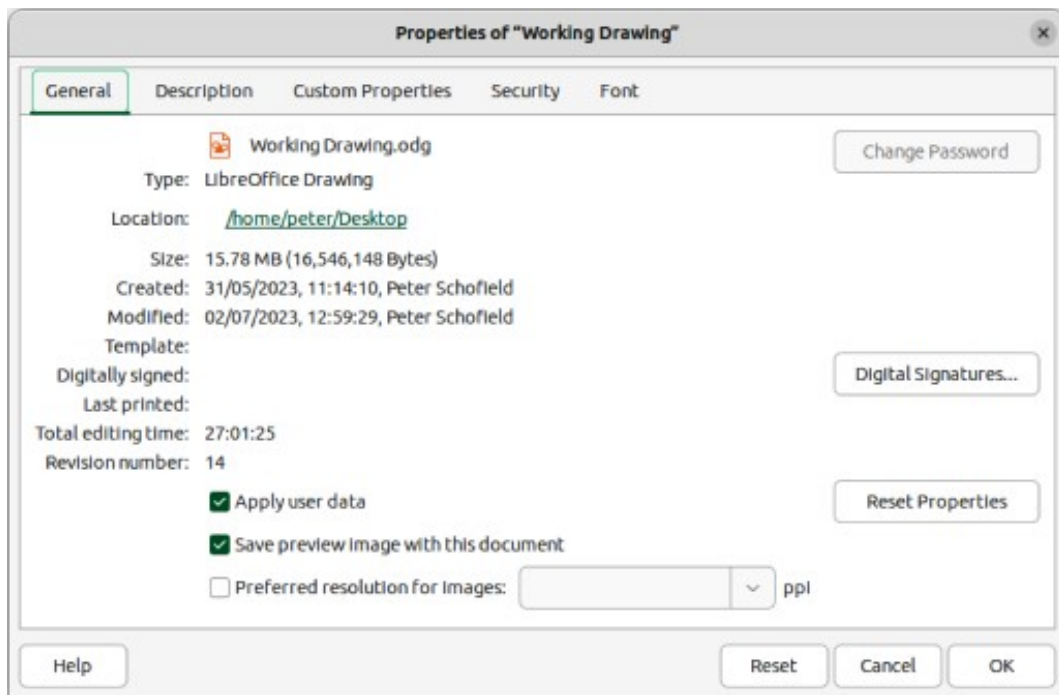

Figure 270: Properties dialog

- Reset the creation date to the current date and time.
 - Reset the version number to 1.
- 4) Click **OK** to save the changes and close the Properties dialog.

Removing version information

To remove any version information from a drawing, use one of the following methods:

- Go to **File > Versions** on the Menu bar to open a properties dialog for the drawing, then select the versions from the **Existing Versions** list for deletion and click **Delete**. The dialog automatically closes.
- Go to **File > Save As** on the Menu bar and save the drawing with a different name.

Redaction

Documents are redacted to remove or hide any sensitive information. Redaction allows the selective disclosure of information in a document while keeping other parts of the document secret.

When a redacted document is exported to a new document, any redacted portions are removed and replaced by redaction blocks of pixels. This prevents any attempt to restore or copy the original contents. A redacted document is often exported in PDF format for publication, or sharing.

Any documents that are redacted in LibreOffice Writer, Calc, or Impress are automatically transferred as a copy to LibreOffice Draw where the redaction is carried out.

Documents, spreadsheets, or presentations

- 1) Open the document to be redacted in LibreOffice Writer, Calc or Impress, then go to **Tools > Redact** on the Menu bar and the following happens:



Figure 271: Redaction toolbar

- The document is copied, prepared and transferred to LibreOffice Draw as an untitled file.
 - LibreOffice Draw opens with the untitled document displayed.
 - The Redaction toolbar (Figure 271) automatically opens. If the Redaction toolbar is not displayed, go to **View > Toolbars** on the Menu bar in LibreOffice Draw and select **Redaction**.
- 2) Go to **Tools > Redact** on the Menu bar and select either **Rectangle** or **Freeform**, or click on **Rectangle Redaction** or **Freeform Redaction** in the Redaction toolbar.
 - 3) Draw the required shapes to redact the sensitive areas in the document. The redaction shape is gray allowing the sensitive areas in the document to be visible before they are redacted.
 - 4) If necessary, click on **Export Preview PDF** to create a PDF copy of the document, then save as a PDF file. Any sensitive information in the redacted areas can then be reviewed before redaction is finalized.
 - 5) If necessary, delete the PDF copy after reviewing the redaction areas in the file.
 - 6) Go to **Tools > Redact** on the Menu bar and select either **Redacted Export (White)**, or **Redacted Export (Black)**, or click on **Redacted Export (White)**, or Redacted Export (Black) in the Redaction toolbar.
 - 7) Navigate to the folder in the file browser window that opens where the redact document is going to be saved and enter a name for the document.
 - 8) Click on **Save** to create the redacted PDF file as follows:
 - The gray redaction shapes are converted to white, or black shapes and the document is exported as a PDF
 - There is no selectable text in the PDF file and any redacted content is non-existent.

Drawings

Open a drawing in Draw, then use Steps 2) thru 8) in “Documents, spreadsheets, or presentations” above to create a redacted PDF copy of the drawing file.

✓ Note

When a redacted document is exported as a new PDF file, any redacted portions are removed from the new document and replaced by redaction blocks of pixels. This prevents any attempt to restore, or copy the original contents that have been redacted.



LibreOffice
Community



Draw Guide 7.5

Chapter 11, Advanced Draw Techniques

Drawing pages

Pages pane

Drawings created in Draw can consist of multiple pages and stored as one file on a computer. Drawing pages are displayed as thumbnails in the **Pages** pane which is used to add, rename, delete, and arrange pages in a drawing.

By default the **Pages** pane (Figure 272) appears docked on the left of the **Workspace**. If the **Pages** pane is not visible, go to **View > Page Pane** on the Menu bar. The **Pages** pane also becomes a floating window using one of the following methods:

- **Windows and Linux only** — press and hold the *Ctrl* key, then double-click in the title bar of the **Pages** pane to create a floating window.
- **macOS only** — press and hold the \mathfrak{K} key, then double-click in the title bar of the **Pages** pane to create a floating window.
- **Windows, Linux and macOS** — click in the title bar and drag the **Pages** pane to create a floating window.
- Click on the **X** on the right side of the title bar and close the **Pages** pane, or deselect **View > Page Pane** in the Menu bar.

Selecting pages

To make a page appear in the **Workspace**, select a page using one of the following methods:

- Select a page in the **Pages** pane.

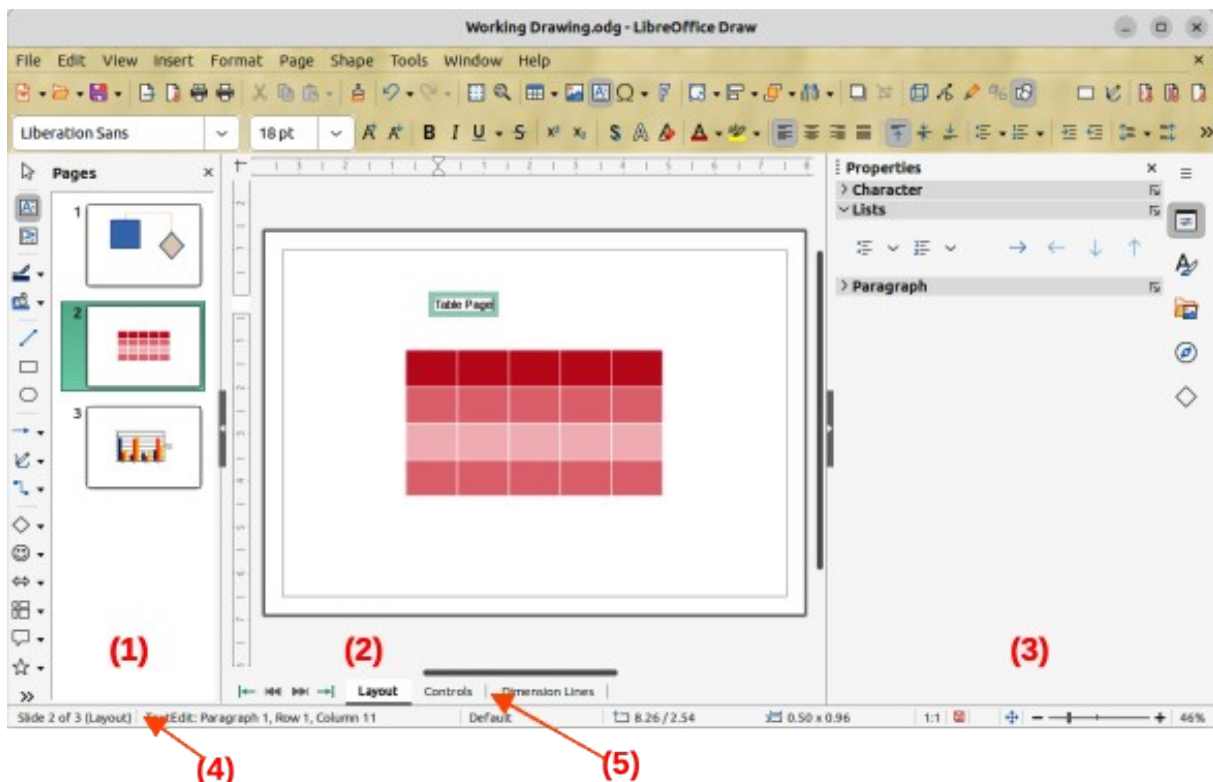

Figure 272: Draw main window

- | | |
|---------------|---------------|
| 1) Pages pane | 4) Status bar |
| 2) Workspace | 5) Layers bar |
| 3) Sidebar | |

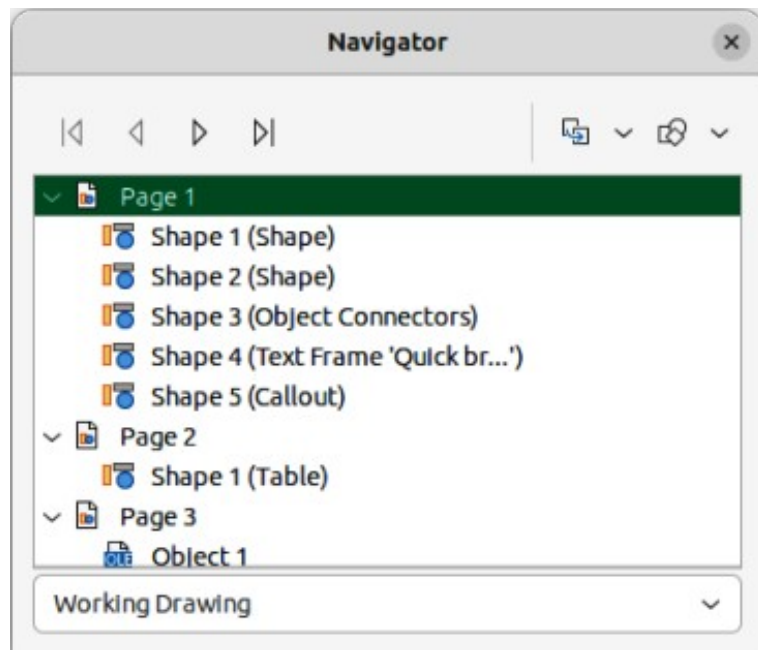

Figure 273: Navigator dialog

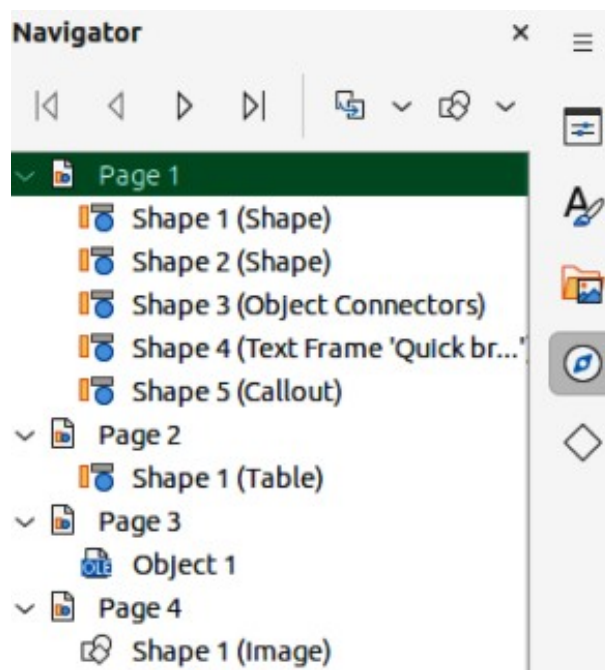

Figure 274: Navigator deck in Sidebar

- Use the keyboard shortcut **F5**, or go to **View > Navigator** on the Menu bar to open the Navigator dialog (Figure 273) and select a page from the displayed list.
- Click on **Navigator** in the Sidebar to open the Navigator deck in the Sidebar (Figure 274) and select a page from the displayed list.

Navigating pages

To navigate a multi-page drawing and select a page for editing, use one of the following methods:

- Select the required page in the **Pages** pane.
- Select the required page in the Navigator dialog, or the Navigator deck in the Sidebar.

- Go to **Page > Navigate** on the Menu bar and select one of the options from the submenu:
 - **To First Page** — moves the selection to the first page in the drawing.
 - **To Previous Page** — moves the selection backward to the previous page.
 - **To Next Page** — moves the selection forward to the next page.
 - **To Last Page** — moves the selection to the last page in the drawing.

Adding pages

Inserting new page

Insert a new page into a drawing using one of the following methods. A new page is added after the selected page in the **Pages** pane, or at the end of the pages if no page is selected.

- Go to **Page > New Page** on the Menu bar.
- Right-click in the **Pages** pane and select **New Page** from the context menu.
- Right-click on the page displayed in the **Workspace** and select **Page > New Page** from the context menu.
- Go to **Page > Insert Page from File** on the Menu bar and open the Insert File dialog. Navigate to the folder where the file is located. Select the file and click on **Open** to open the Insert Pages dialog (Figure 275). Select the required pages and click **OK** and the selected pages are inserted into the drawing.

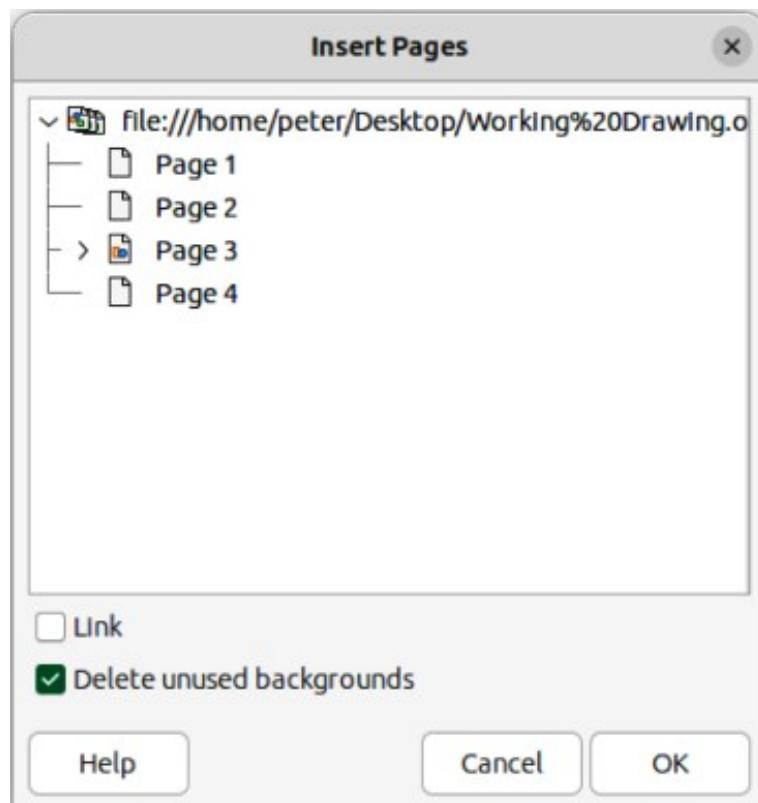

Figure 275: Insert Pages dialog

Duplicating pages

Select a page in the **Pages** pane, then use one of the following methods to insert the duplicate page after the selected page:

- Go to **Page > Duplicate Page** on the Menu bar.
- Right-click on a page in the **Pages** pane and select **Copy** from the context menu.
Right-click in a blank area of the **Pages** pane and select **Paste** from the context menu.

Renaming pages

When pages are inserted into a drawing, they are automatically named as Page 1, Page 2, and so on in the **Pages** pane, the Navigator dialog, or the Navigator deck in the Sidebar. As the page order is changed, pages are automatically renumbered making it difficult to identify the pages. To solve the problem of identifying pages, it is recommended to give each page a memorable name.

- 1) Select a page for renaming in the **Pages** pane.
- 2) Use one of the following methods and rename the selected page:
 - Go to **Page** on the Menu bar and select **Rename Page** from the submenu.
 - Right-click on the selected page in the **Pages** pane and select **Rename Page** from the context menu.
 - Right-click on the page displayed in the **Workspace** and select **Page > Rename Page** from the context menu.
- 3) In the Rename Page dialog that opens, type a new name for the page and click **OK**.

Changing page order

Use one of the following methods and change the page order in a drawing:

- Select a page thumbnail in the **Pages** pane, then click and drag the page thumbnail to change the page order.
- Select a page thumbnail in the **Pages** pane, then go to **Page > Move** on the Menu bar and select one of the following options:
 - **Page to Start** — moves the selected page to the beginning of the drawing.
 - **Page Up** — moves the selected page up one place in the page order of the drawing.
 - **Page Down** — moves the selected page down one place in the page order of the drawing.
 - **Page to End** — moves the selected page to the end of the drawing.

Deleting pages

- 1) Select a page for deletion in the **Pages** pane.
- 2) Use one of the following methods to delete the selected page:
 - Go to **Page > Delete Page** on the Menu bar.
 - Right-click on the selected page in the **Pages** pane and select **Delete Page** from the context menu.
 - Right-click on the page displayed in the **Workspace** and select **Page > Delete Page** from the context menu.

✓ Note

When deleting pages in a drawing, there is no confirmation of deletion for the selected page.

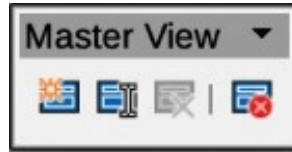

Figure 276: Master View toolbar

Master pages

A master page is a page used as a starting point for all pages in a drawing controlling the basic formatting of all pages based on the master page. It is similar to a page style in Writer, or master slide in Impress. A drawing with multiple pages can have more than one master page allowing a different look assigned to separate pages in a drawing, for example title page, contents page, and drawing pages.

A master page has a defined set of characteristics. For example, background objects (such as logos, decorative lines), text formatting, blocks of standard text, and fields such as page numbering, date, and filename.

Master page view

Go to **View > Master** on the Menu bar and open the master page view. This also opens the Master View toolbar (Figure 276). If this toolbar does not open, go to **View > Toolbars > Master View** on the Menu bar.

To return to normal page mode, click on **Close Master View** in the Master View toolbar, or go to **View > Normal** on the Menu bar.

Creating master pages

Each drawing created uses the default master page. When a drawing has multiple pages, master pages are created and added to the drawing as follows:

- 1) Go to **View > Master** on the Menu bar to open the master page view and the Master View toolbar.
- 2) Create a new master page using one of the following methods. After creation, the new master page is automatically selected.
 - Click on **New Master** in the Master View toolbar.
 - Go to **Page > New Master** on the Menu bar.
 - Right-click in the **Pages** pane and select **New Master** from the context menu.
- 3) Add the required graphic objects, logos, fields, text and so on to the selected master page, then save the drawing.
- 4) Assign the new master page to a drawing page. See “Changing master pages” on page 275 for more information.
- 5) If necessary, rename the master page with a meaningful name, see “Renaming master pages” on page 274.

Renaming master pages

Each new master page created has the default name of Default 1, Default 2, and so on. It is recommended to rename a new master page with a more meaningful name. The default master page that was created when the drawing was created can also be renamed.

- 1) Go to **View > Master** on the Menu bar to open the master page view and the Master View toolbar.
- 2) Use one of the following methods and open the Rename Master Slide dialog:
 - Click on **Rename Master** in the Master View toolbar.
 - Right-click on a master page in the **Pages** pane and select **Rename Master** from the context menu.
- 3) Enter a meaningful name for the master page in the **Name** text box in the Rename Master dialog.
- 4) Click **OK** to save the changes and close the Rename Master Slide dialog.

Changing master pages

When a drawing uses several master pages, each page in the drawing can use a different master page.

- 1) Go to **View > Normal** on the Menu bar.
- 2) In the **Pages** pane, select the page where the master page is going to be changed.
- 3) Right-click on the page in the **Workspace** and select **Change Slide Master** from the context menu to open the Available Master Slides dialog (Figure 277).
- 4) In the **Select a Slide Design** preview box, select a master page design for the selected page.

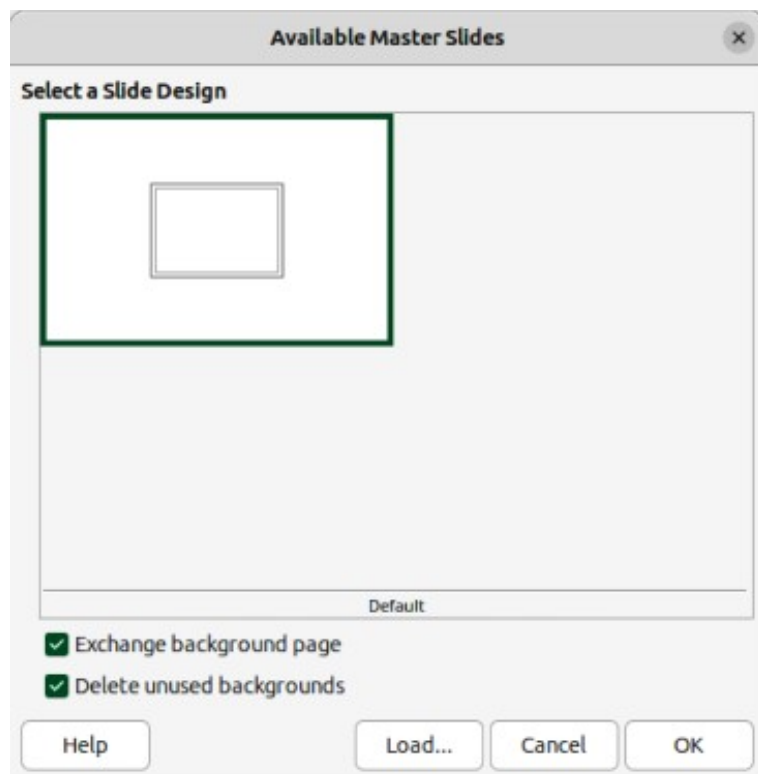

Figure 277: Available Master Slides dialog

- 5) If necessary, select **Exchange background page** to use the selected master page for all pages in the drawing.
- 6) If necessary, select **Delete unused backgrounds** to delete any master pages shown in **Select a Slide Design** preview box that have not been assigned to a page.
- 7) Click **OK** to change the selected master page and close the Available Master Slides dialog.

Deleting master pages

Deleting master pages is only available when there is more than one master page in a drawing.

- 1) Go to **View > Master** on the Menu bar to open the master page view and the Master View toolbar.
- 2) Use one of the following methods to delete a master page. The deletion of the master page is immediate and there is no confirmation
 - Select and right-click on a master page in the **Pages** pane and select **Delete Master** from the context menu.
 - Click on **Delete Master** in the Master View toolbar.
 - Go to **Page > Delete Master** on the Menu bar.

Note

The default master page created when the drawing was first created cannot be deleted. Also, if the drawing only uses one named master page, then that named master page cannot be deleted.

Master pages from templates

Master pages from templates available in LibreOffice can be used for a drawing. If the master pages from a template use a different page size, the master pages loaded into a drawing are adapted to the page size used in the drawing. This may cause some objects to be stretched, or incorrectly positioned when adapted to fit the drawing page size.

- 1) Go to **View > Master** on the Menu bar to open the master page view and the Master View toolbar.
- 2) Right-click on a master page displayed in the drawing and select **Change Master Slide** from the context menu to open the Available Master Slides dialog (Figure 277 on page 275).
- 3) Click on **Load...** to open the Load Master Slide dialog (Figure 278).
- 4) Choose a template category from the list displayed in **Categories**.
- 5) Choose a template from the list displayed in **Templates**.
- 6) If necessary, click on **Preview** to display a preview of the selected template.
- 7) Click **OK** to close the Load Master Slide dialog. The Available Master Slides dialog opens displaying the selected template in **Select a Slide Design**.
- 8) Select the master page required in **Select a Slide Design**.
- 9) If necessary, select **Exchange background page** to use the selected master page for all pages in the drawing.
- 10) If necessary, select **Delete unused backgrounds** to delete any master pages shown in **Select a Slide Design** that have not been assigned to a page.

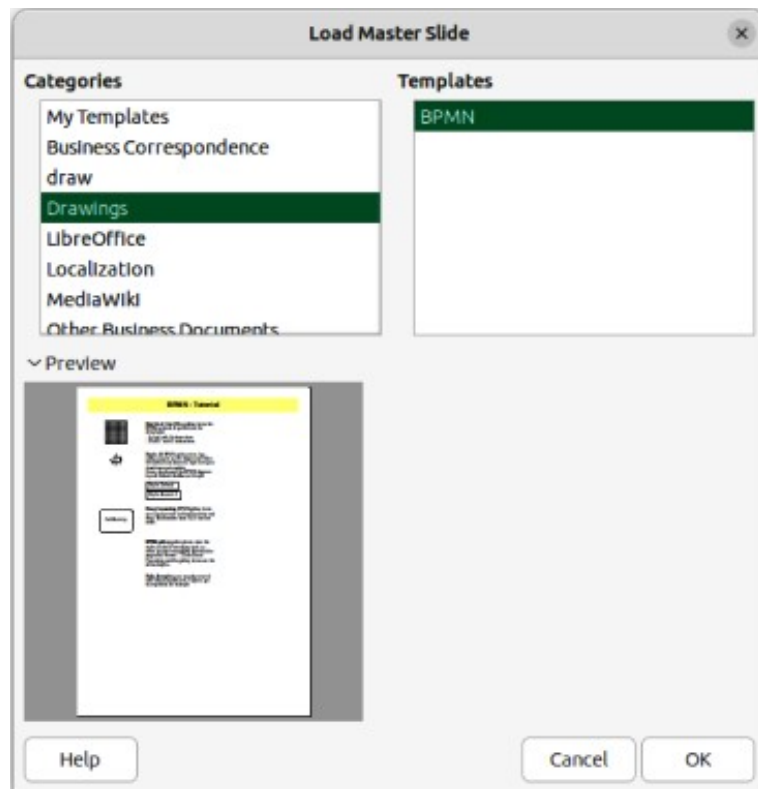

Figure 278: Load Master Slide dialog

- 11) Click **OK** to assign the selected master page to a drawing page and close the Available Master Slides dialog.

Inserting fields

- 1) Go to **View > Master** on the Menu bar to open the master page view and the Master View toolbar.
- 2) Go to **Insert > Field** on the Menu bar and select a field type from the options available on the submenu. The selected field appears in the middle of the drawing page.
- 3) Select the inserted field so that the border is displayed.
- 4) Click on the border and drag the field to the required position.
- 5) If necessary, format the text used in the field to the drawing requirements. For more information, see Chapter 9, Adding and Formatting Text.

The field types that are available for insertion as follows:

Date (fixed)

Inserts the current date into the master page as a fixed field. The date is not automatically updated.

Date (variable)

Inserts the current date into the master page as a variable field. The date is automatically updated each time the file is opened.

Time (fixed)

Inserts the current time into the master page as a fixed field. The time is not automatically updated.

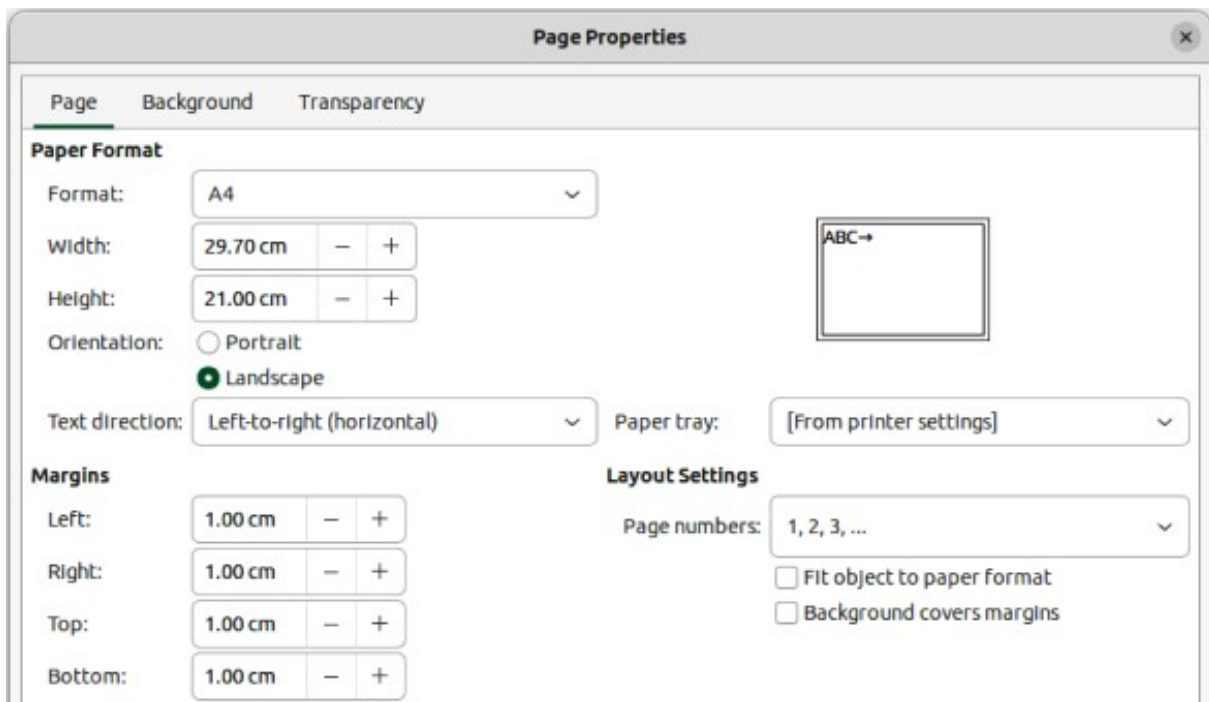

Figure 279: Page Properties dialog

Time (variable)

Inserts the current time into the master page as a variable field. The time is automatically updated each time the file is opened.

Author

Inserts the first and last names listed in the LibreOffice user data into the active page. Go to **Tools > Options > LibreOffice > User Data** (macOS **LibreOffice > Preferences > LibreOffice > User Data**) on the Menu bar to enter user data details.

Page Number

Inserts the page number into every page of the drawing. To change the number format, go to **Page > Page Properties** on the Menu bar to open the Page Properties dialog (Figure 279). Click on the **Page** tab and select a number format from the drop-down list in **Layout Settings**.

Page Title

Inserts the page title. A page title is created in Normal view by going to **Page > Rename Page** on the Menu bar and entering a title in the *Name* text box in the Rename Page dialog that opens. For more information, see “Renaming pages” on page 273.

Page Count

Inserts the total number of pages in a drawing.

File Name

Inserts the name of the active file. The name only appears after the file has been saved.

Editing field format

- 1) Go to **View > Master** on the Menu bar to open the master page view and the Master View toolbar.
- 2) Click on a field to select it and display the selection handles.
- 3) Click on the field contents and make sure the cursor is at the beginning of the field.

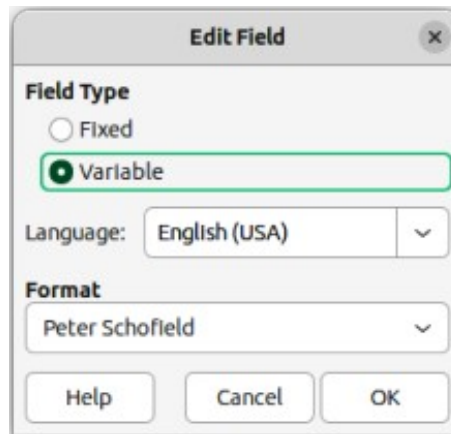

Figure 280: Edit Field dialog

- 4) Edit the field format using one of the following methods:
 - Go to **Edit > Fields** on the Menu bar to open the Edit Field dialog (Figure 280), then select format option(s) and click **OK** to save the changes.
 - Right-click on the selected field contents and select a format option from the context menu.
- 5) Click in a blank area of the master page to deselect the field.

Note

The options available in the Edit Field dialog and context menu change to match the field type that has been selected for editing.

Templates

A drawing template is used as the starting point for all new drawings. For example, a template can include a company logo, name and information on the first page of a drawing with the remaining pages in a drawing only showing the company logo and name. Templates can contain anything that regular drawings can contain, such as text, graphics, a set of styles, and so on.

All document types created using LibreOffice are based on templates. If a template is not specified when a new document is started, then the default template for that type of document is used. This default template uses a set of properties that are hard coded into LibreOffice. If necessary, the default template for drawings that is hard coded in LibreOffice can be changed, see “Default template” on page 282 for more information.

For more information on templates and obtaining templates from other sources, see the *Getting Started Guide*.

Draw does not have any predefined templates when it is installed on a computer. However, templates can be created using methods described in the following sections. Templates can be installed that have been obtained from other sources, see “Importing templates” on page 286 for more information.

Creating templates

Using Save As Template dialog

- 1) Open a drawing to use as a basis for a template, or open and edit a template to use as a basis for a new template.

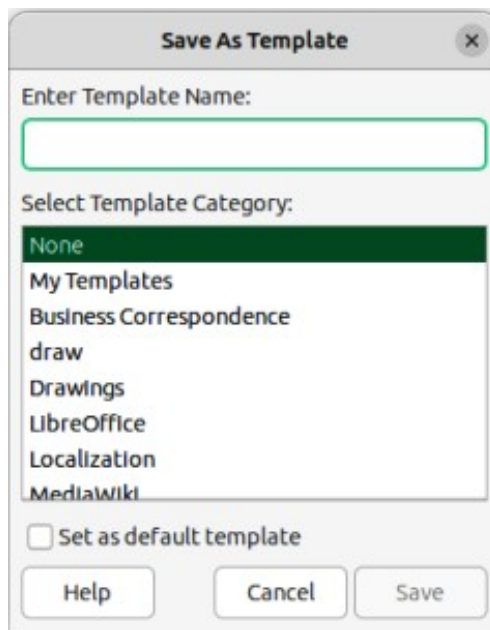

Figure 281: Save As Template dialog

- 2) Add any extra content and styles, or edit the content and styles to the template requirements.
- 3) Use one of the following methods to open the Save As Template dialog (Figure 281):
 - Go to **File > Templates > Save As Template** on the Menu bar.
 - Click on the triangle ▼ to the right of **Save** on the Standard toolbar and select **Save as Template** from the drop-down menu.
- 4) Enter a name for the template in the **Enter Template Name** text box.
- 5) Select a template category from the list available in the **Select Template Category** box.
- 6) If the new template is to be used as the default template in Draw, select the option **Set as default template**.
- 7) Click on **Save** to save the template and close the Save As Template dialog.

Using Save As command

- 1) Go to **File > Save As** on the Menu bar, or use the keyboard shortcut *Shift+Ctrl+S* (macOS *⌘+Ctrl+S*) to open the Save as dialog.
- 2) Navigate to the LibreOffice templates folder. Actual location of the LibreOffice template folder depends on the computer system and setup.
- 3) Enter a filename using the extension OTG in the *Name* box.
- 4) From the drop-down list, select *ODF Drawing Template (.otg)* as the file type.
- 5) Click on **Save** to save the template and close the dialog.

✓ Note

When saving a drawing as a template, the template must be saved in the LibreOffice templates folder for the template to be recognized and found by the LibreOffice Template Manager. See “Template folder location” on page 284 for more information.

Creating drawings from templates

Start Center

Open LibreOffice and create a new drawing from a template displayed in the **Start Center** using one of the following methods:

- Click on **Templates** in the **Start Center** to open a display of available templates for all LibreOffice applications. Click on the required template and a new document opens using the relevant LibreOffice module for the template.
- Click on the triangle ▼ to the right of **Templates** in the **Start Center**, then select **Draw Templates** to only display the LibreOffice Draw templates. Click on the required template and a new drawing opens using LibreOffice Draw.

Templates dialog

- 1) Use one of the following methods to open the Templates dialog (Figure 282):
 - Go to **File > New > Templates** on the Menu bar.
 - Go to **File > Templates > Manage Templates** on the Menu bar.
 - Use the keyboard short cut *Ctrl+Shift+N* (macOS *⌘+Shift+N*).
- 2) Select *Drawings* from the **Filter** drop-down list.
- 3) Select a category from the options available in the **All Categories** drop-list.
- 4) Select a template from the options available in the preview box.

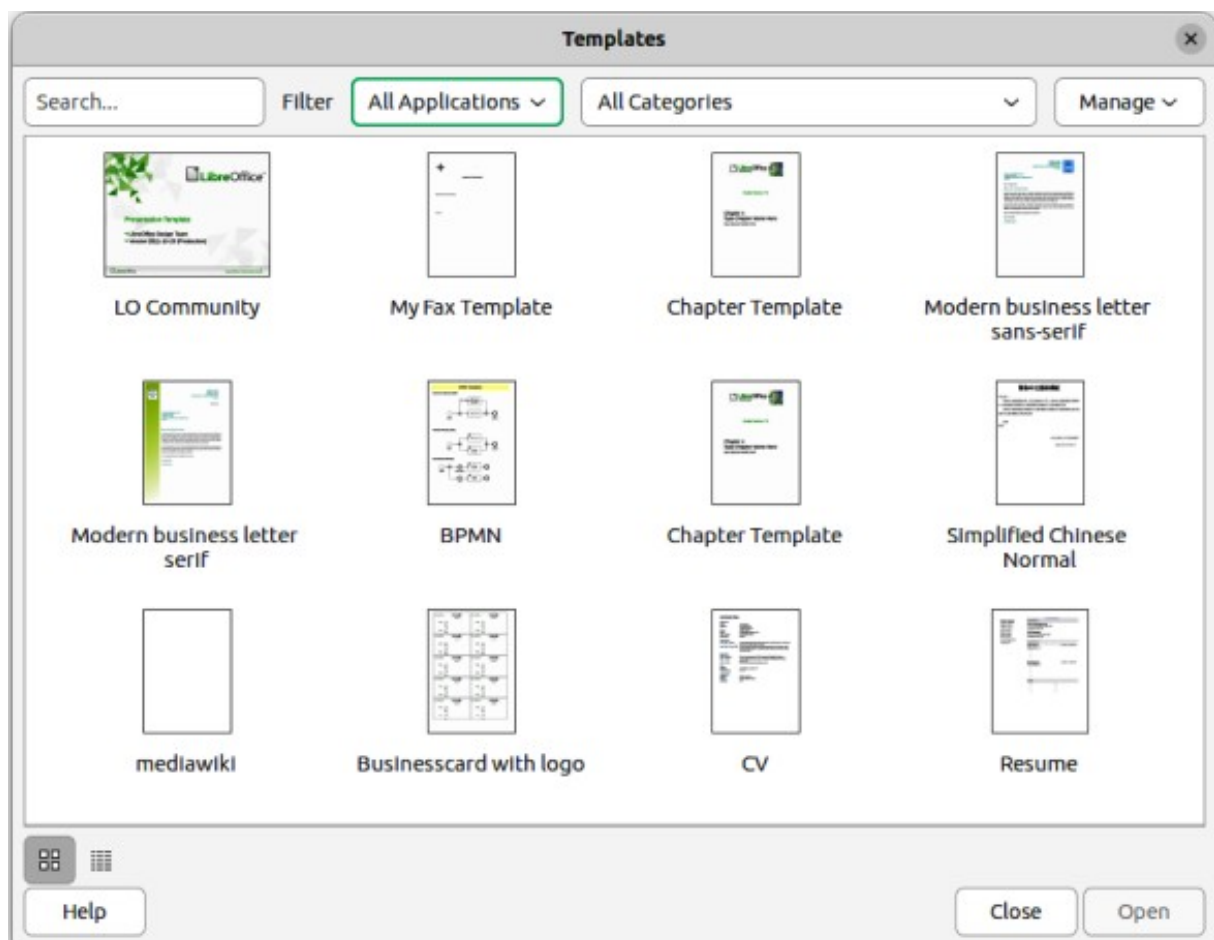

Figure 282: Templates dialog

- 5) Click **Open**, or double click on the template to create a new drawing using the selected template and close the Template dialog.
- 6) Go to **File > Save As** on the Menu bar and save the new drawing as a file using the extension ODG.

Default template

If a new drawing is created without selecting a template, LibreOffice creates the drawing using a set of properties that are hard coded in LibreOffice. However, any drawing template can be used as the default template for LibreOffice Draw. The selected template must be located in the templates folders used for LibreOffice applications and categories, see “Template folder location” on page 284 for more information.

Setting default template

- 1) Use one of the following methods to open the Templates dialog:
 - Go to **File > New > Templates** on the Menu bar.
 - Go to **File > Templates > Manage Templates** on the Menu bar.
 - Use the keyboard short cut *Ctrl+Shift+N* (macOS *⌘+Shift+N*).
- 2) Select *Drawings* from the **Filter** drop-down list.
- 3) Select a category from the options available in the **All Categories** drop-list.
- 4) Select a template from the options available in the preview box.
- 5) Right-click on the selected template and select **Set as default** from the context menu. There is no confirmation that the selected template is now the default template for new drawings. The default template is indicated by check mark at the top left corner of the template icon.
- 6) Click on **Close** to close the Templates dialog. The next time a new drawing is created, it uses the new default template.

Note

If a new drawing is suitable to use as the default template, then the drawing must be saved as a template first before it can be used as the default template. See “Creating templates” on page 279 for more information.

Resetting default template

- 1) Use one of the following methods to open the Templates dialog:
 - Go to **File > New > Templates** on the Menu bar.
 - Go to **File > Templates > Manage Templates** on the Menu bar.
 - Use the keyboard short cut *Ctrl+Shift+N* (macOS *⌘+Shift+N*).
- 2) Select *Drawings* from the **Filter** drop-down list.
- 3) Select a category from the options available in the **All Categories** drop-list.
- 4) Right-click on the default template. The default template is indicated by check mark at the top left corner of the template icon.
- 5) Select **Reset Default** from the context menu. There is no confirmation that Draw has been reset to using LibreOffice default properties. The check mark is removed from the template icon.

- 6) Click on **Close** to close the Templates dialog. The next time a new drawing is created, it uses the LibreOffice default template.

Tip

To reset all default templates for all LibreOffice modules, click on **Manage** in the Templates dialog and select **Reset All Default Templates** from the drop-down list.

Editing templates

Template styles and template content can be edited and, if necessary, reapplied to drawings that were created from that template. Any content in the drawing, but not included in the template, cannot be reapplied.

Note

Templates that were supplied with LibreOffice cannot be deleted. Only templates that have been created using LibreOffice, or imported into LibreOffice, can be edited, or deleted.

Editing

- 1) Use one of the following methods to open the Templates dialog:
 - Go to **File > New > Templates** on the Menu bar.
 - Go to **File > Templates > Manage Templates** on the Menu bar.
 - Use the keyboard short cut *Ctrl+Shift+N* (macOS *⌘+Shift+N*).
- 2) Select a template that was created using LibreOffice, or imported into LibreOffice.
- 3) Right-click on the selected template and select **Edit** from the context menu. The template opens in Draw.
- 4) Edit the template as any other drawing.
- 5) Go to **File > Save** on the Menu bar, or use the keyboard shortcut *Ctrl+S* (macOS *⌘+S*) to save the template.
- 6) Alternatively, save the edited template as a new template. See “Creating templates” on page 279 for more information.

Updating drawings from modified template

If a drawing is opened and the template has been modified, a confirmation dialog opens asking to update the styles in the drawing to the formatting used in the modified template.

- Select **Update Styles** to update any styles in the drawing that have been changed in the template and close the confirmation dialog.
- Select **Keep Old Styles** so that styles in the drawing that have been changed in the template are not updated. The confirmation dialog closes and does not appear when the document is reopened. Also, the drawing is no longer connected to the template.

Note

If **Keep Old Styles** the template is still listed under **File > Properties > General**, the template has to be reassigned to reconnect the document to the template. See “Changing templates assigned to drawings” on page 284 for more information.

Changing templates assigned to drawings

If necessary, the template originally used for a drawing can be changed to a different template, or the original template used for the drawing reassigned.

- To manually change, or reassign a template, create a new drawing from the required template and copy the contents from the old drawing into the new drawing.
- Download the Template Changer extension from the LibreOffice website at <https://extensions.libreoffice.org/en/extensions/show/template-changer> and install it into LibreOffice. Restart LibreOffice to activate the extension. Open the drawing and use **File > Templates > Change template (current document)** on the Menu bar to change the template. For more information, see the *Getting Started Guide*.

Organizing templates

LibreOffice can only locate templates that are in LibreOffice template folder. Template categories can be created and used to organize templates, for example creating separate categories for different projects or clients. Templates can also be imported and exported.

Template folder location

The template folder location in LibreOffice varies with the computer operating system. Locating the template folder on a computer is as follows:

- 1) Go to **Tools > Options > LibreOffice > Paths** (macOS **LibreOffice > Preferences > LibreOffice > Paths**) on the Menu bar to open the Options LibreOffice Paths dialog.
- 2) Scroll down to *Templates* in **Paths used by LibreOffice** to identify the template folder used by LibreOffice. The following are examples of the template folder location using different operating systems:

Windows 11 — C:\Users\peter\AppData\Roaming\LibreOffice\4\user\template

Ubuntu 23.04 — /home/peter/.config/libreoffice/4/user/template;/home/peter/Templates

macOS Ventura 13.5 — /Users/peter/Library/Application Support/LibreOffice/4/user/templates

Creating template categories

- 1) Use one of the following methods to open the Templates dialog:
 - Go to **File > New > Templates** on the Menu bar.
 - Go to **File > Templates > Manage Templates** on the Menu bar.
 - Use the keyboard short cut *Ctrl+Shift+N* (macOS *⌘+Shift+N*).
- 2) In the Filter drop-down lists, select **Drawings** as the application.
- 3) In **Manage**, select **New Category** from the drop-down list.
- 4) Enter a name in the **Enter category name** text box in the dialog that opens.
- 5) Click **OK** to save the new category in LibreOffice and close the dialog.

Renaming template categories

Template categories originally installed with LibreOffice cannot be renamed. Only template categories that have been created after the LibreOffice installation can be renamed.

- 1) Use one of the following methods to open the Templates dialog:
 - Go to **File > New > Templates** on the Menu bar.

- Go to **File > Templates > Manage Templates** on the Menu bar.
 - Use the keyboard short cut *Ctrl+Shift+N* (macOS *⌘+Shift+N*).
- 2) In the Filter drop-down lists, select **Drawings** as the application.
 - 3) Select the category for renaming from the options available in the **All Categories** drop-down list.
 - 4) In **Manage**, select **Rename Category** from the drop-down list.
 - 5) Enter a name in the **Rename Category** text box in the dialog that opens.
 - 6) Click **OK** to save the renamed category in LibreOffice and close the dialog.

✓ Note

For categories installed with LibreOffice, the options **Rename Category** and **Delete Category** are grayed out indicating that these options are not available

Deleting template categories

Template categories installed with LibreOffice cannot be deleted. Only template categories that have been created after the LibreOffice installation can be deleted.

- 1) Use one of the following methods to open the Templates dialog:
 - Go to **File > New > Templates** on the Menu bar.
 - Go to **File > Templates > Manage Templates** on the Menu bar.
 - Use the keyboard short cut *Ctrl+Shift+N* (macOS *⌘+Shift+N*).
- 2) Select the category for deletion from the options available in the **All Categories** drop-list.
- 3) In **Manage**, select **Delete Category** from the drop-down list.
- 4) Click on **Yes** in the warning message to confirm the deletion of the category.

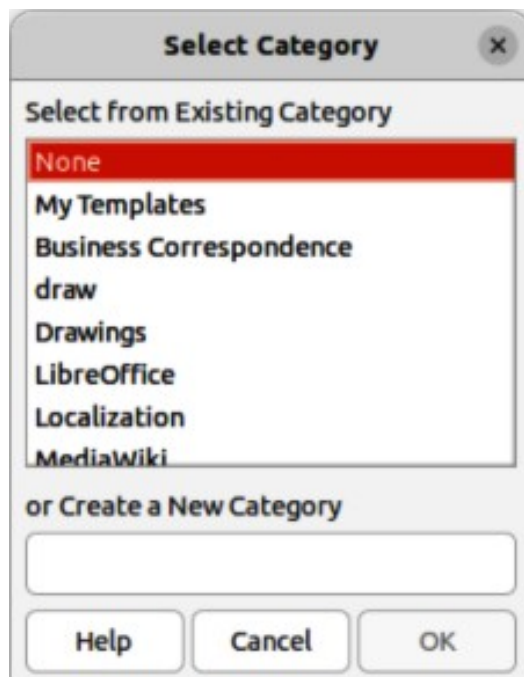

Figure 283: Select Category dialog

Moving templates

- 1) Use one of the following methods to open the Templates dialog:
 - Go to **File > New > Templates** on the Menu bar.
 - Go to **File > Templates > Manage Templates** on the Menu bar.
 - Use the keyboard short cut *Ctrl+Shift+N* (macOS *⌘+Shift+N*).
- 2) In the Filter drop-down list, select **Drawings** as the application.
- 3) Select the template category from the options available in the **All Categories** drop-down list.
- 4) Right-click on the template that is going to be moved and select **Move** from the context menu to open the Select Category dialog (Figure 283).
- 5) Select a category from **Select from Existing Category**, or enter a name for a new category in **Create a New Category**.
- 6) Click **OK** to move the template to the selected category and close the Select Category dialog.

Importing templates

Using the Extension Manager, templates can be downloaded from many sources, including the official LibreOffice template repository. For more information about using the Extension Manager to import templates, see the *Getting Started Guide*.

Save the template on a computer, then import the template into the LibreOffice template folder as follows:

- 1) Use one of the following methods to open the Templates dialog:
 - Go to **File > New > Templates** on the Menu bar.
 - Go to **File > Templates > Manage Templates** on the Menu bar.
 - Use the keyboard short cut *Ctrl+Shift+N* (macOS *⌘+Shift+N*).
- 2) Click on **Manage** and select **Import** from the context menu to open the Select Category dialog (Figure 283).
- 3) Select a category from **Select from Existing Category**, or enter a name for a new category in **Create a New Category**.
- 4) Click **OK** and a file browser window opens.
- 5) Navigate to the folder containing the template, select the template and click **Open**. The file browser closes and the template appears in the selected template category in the Templates dialog.

Exporting templates

Export a template from a template category to another location in a computer, or network, as follows:

Note

Exporting a template does not remove it from the Templates dialog, or template folder. Exporting places a copy of the template in the location specified.

- 1) Use one of the following methods to open the Templates dialog:
 - Go to **File > New > Templates** on the Menu bar.

- Go to **File > Templates > Manage Templates** on the Menu bar.
 - Use the keyboard short cut *Ctrl+Shift+N* (macOS *⌘+Shift+N*).
- 2) In the Filter drop-down list, select **Drawings** as the application.
 - 3) Select the required template category from the options available in the **All Categories** drop-down list.
 - 4) Right-click on the required template and select **Export** from the context menu to open a file browser window.
 - 5) Navigate to the folder to export the template into.
 - 6) Click **OK** and the exported template appears in the selected folder.
 - 7) Click on **Close** to close the Templates dialog.

Deleting templates

- 1) Use one of the following methods to open the Templates dialog:
 - Go to **File > New > Templates** on the Menu bar.
 - Go to **File > Templates > Manage Templates** on the Menu bar.
 - Use the keyboard short cut *Ctrl+Shift+N* (macOS *⌘+Shift+N*).
- 2) In the Filter drop-down list, select **Drawings** as the application.
- 3) Select the required template category from the options available in the **All Categories** drop-down list.
- 4) Right-click on the template being deleted and select **Delete** from the context menu.
- 5) Click on **Yes** to confirm the deletion of the template.
- 6) Click on **Close** to close the Templates dialog.

✓ Note

Templates installed with LibreOffice cannot be deleted. Only templates that have been created after the installation of LibreOffice can be deleted.

Multiple layers

Layers in LibreOffice Draw allow assembly of related elements in a drawing. Think of layers as individual workspaces that can be hidden from view, prevented from printing, or locked so that changes cannot be made.

Layers do not determine the stacking order of objects on a drawing, except for the **Controls** layer, which is always in front of all other layers. The stacking order of objects on a drawing is determined when objects are added. The stacking order of objects can be rearranged by going to **Shape > Arrange** on the Menu bar.

Layers in a drawing are indicated by tabs located at the bottom of the **Workspace** and above the **Status bar**, as shown in Figure 284. By default, the **Layout** tab is always selected when a drawing is opened. Click on another tab to select another layer in the drawing.

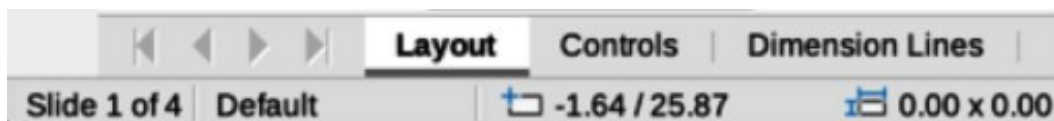

Figure 284: Example of Layers tab in Draw

✓ Notes

When a new layer is added, the layer is added to all pages in a drawing. However, when an object is added to a layer, the object is only added to the selected drawing page.

If an object is to appear on all drawing pages (for example, a company logo), add the object to the master page by going to **View > Master** on the Menu bar. See “Master pages” on page 274 for more information.

Default layers

Normal view

In **Normal** view, LibreOffice Draw provides three default layers that are visible to the user. These default layers cannot be deleted or renamed.

Layout

The default workspace where objects are normally placed.

Controls

Used for form controls that have been assigned an action. Objects on this layer are always in front of objects on other layers. To prevent form controls from being visible on a drawing, deselect the **Visible** option in the Insert Layer or Modify Layer dialog. To prevent form controls from being printed, deselect the **Printable** option in the Insert Layer or Modify Layer dialog.

Dimension Lines

When dimension lines are drawn, the dimension lines are automatically placed on this layer. To prevent dimension lines from being visible on a drawing, deselect the **Visible** option in the Insert Layer or Modify Layer dialog. To prevent dimension lines from being printed, deselect the **Printable** option in the Insert Layer or Modify Layer dialog.

Master view

In **Master** view, LibreOffice provides a single layer, **Background objects**. This layer is used to place objects that appear on every page in a drawing, for example company logo, date, page number, drawing title, and so on.

Inserting layers

- 1) Use one of the following methods to open the Insert Layer dialog (Figure 285):
 - Right-click the layer tab area at the bottom of the **Workspace** area and select **Insert Layer** from the context menu.
 - Go to **Insert > Layer** on the Menu bar.
- 2) Enter meaningful names for the layer in the **Name** and **Title** text boxes.
- 3) If necessary, enter a description for the new layer in the **Description** text box.
- 4) Select **Visible** for the layer to be visible in a drawing. When **Visible** is not selected, the layer is hidden and its name in the layer tab changes color to blue.
- 5) Select **Printable** for the layer to print when the drawing is printed. The name of a layer is underlined in the layer tab bar when **Printable** is not selected. For example, not printing a layer is useful if the layer is a draft layer for guides or annotations used in creating the drawing, but this draft layer is not required for the final printed output.

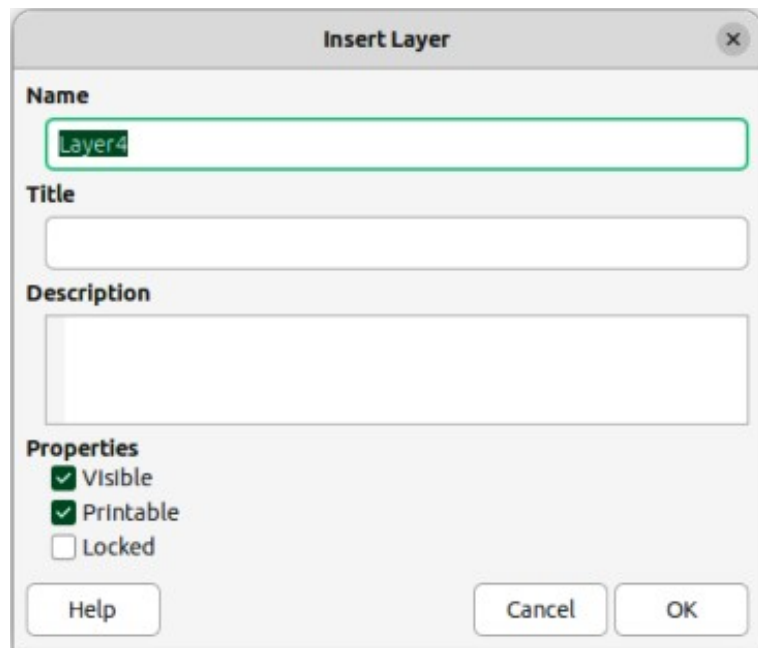

Figure 285: Insert Layer dialog

- 6) Select **Locked** to prevent any objects on a layer from deletion, editing, or moving. No additional objects can be added to a locked layer. The name of a locked layer is changes to Italic text in the layer tab bar. For example, locking a layer is useful when a base plan is to be protected while adding a new layer with other details.
- 7) Click **OK** to close the Insert Layer dialog and the new layer automatically becomes active.

Modifying layers

- 1) Select the layer that is going to be modified.
- 2) Use one of the following methods to open the Modify Layer dialog. The Modify Layer dialog is similar to the Insert Layer dialog (Figure 285):
 - Right-click the layer tab area at the bottom of the **Workspace** area and select **Modify Layer** from the context menu.
 - Go to **Format > Layer** on the Menu bar.
 - Double click on the layer tab.
- 3) Make the necessary changes to the attributes for the layer.
- 4) Click **OK** to save the changes and close the Modify Layer dialog.

Working with layers

Selecting a layer

Click on the layer name tab in the **Layers** tab bar to select and activate the layer. Objects added to the drawing are only added to the active layer. Form controls are automatically added to the **Controls** layer and dimension lines are automatically added to the **Dimension Lines** layer.

If there are several layers in a drawing, a layer tab may not be visible on the **Layers** tab bar. Use the navigation icons on the left of the **Layers** tab bar to navigate to the required layer.

Hiding layers

- 1) Select the layer that is going to be hidden and open the Modify Layer dialog. See “Modifying layers” on page 289 for more information.

- 2) Deselect **Visible** and click **OK**. The text on the layer name tab changes color to blue. Any objects placed on a hidden layer are no longer visible on the other layers of the drawing.
- 3) Alternatively, hold down the *Shift* key and click on the layer name tab to hide the layer.

Showing hidden layers

- 1) Select the hidden layer that and open the Modify Layer dialog. See “Modifying layers” on page 289 for more information.
- 2) Select **Visible** and click **OK**. The text on the layer name tab changes color to the default text color. Any objects placed on a hidden layer are now visible in the other layers of the drawing.
- 3) Alternatively, hold down the *Shift* key and click on the layer name tab to make the layer visible.

Locking layers

- 1) Select the layer that is going to be locked and open the Modify Layer dialog. See “Modifying layers” on page 289 for more information.
- 2) Select **Locked** and click **OK**. The text on the layer name tab is underlined. Locking a layer prevents any modification of the layer.
- 3) Alternatively, hold down the *Ctrl* (macOS ⌘) key and click on the name tab to lock the layer.

Unlocking layers

- 1) Select the locked layer and open the Modify Layer dialog. See “Modifying layers” on page 289 for more information.
- 2) Deselect **Locked** and click **OK**. The text on the layer name tab is no longer underlined.
- 3) Alternatively, hold down the *Ctrl* (macOS ⌘) key and click on the name tab of the locked layer to unlock it.

Renaming layers

- 1) Select the layer that is going to be renamed and open the Modify Layer dialog. See “Modifying layers” on page 289 for more information.
- 2) Enter a new name in the **Name** text box and click **OK** to save the change.
- 3) Alternatively, right-click on the name tab of the layer and select **Rename Layer** from the context menu. The text becomes editable allowing the name to be changed. Click outside the tab area to save the change.
- 4) Alternatively, hold down the *Alt* key (macOS ⌥) and click on the name tab. The text becomes editable allowing the name to be changed. Click outside the tab area to save the change.

Note

Only layers that have been added to a drawing can be renamed or deleted. The default layers **Layout**, **Controls**, **Dimension Lines** and **Background objects** cannot be renamed or deleted.

Deleting layers

- 1) Right-click on the name tab of the layer that is going to be deleted and select **Delete Layer** from the context menu.

- 2) Confirm the deletion of the layer. The layer and all of the objects on the layer are deleted from the drawing.

Moving objects between layers

If objects are selected on a layer, the **Status bar** indicates how many objects are selected. The position of the moved objects does not change in the drawing and the layer where the objects have been placed is displayed in the **Status bar**. Move the selected objects from one layer to another layer using one of the following methods:

- Click and drag the selected objects to the name tab of the destination layer, then release the cursor.
- Go to **Edit > Cut** on the Menu bar or right-click on the selected objects and select **Cut** from the context menu. Select the destination layer, then go to **Edit > Paste** on the Menu bar, or right-click on the **Workspace** and select **Paste** from the context menu.

Dimensioning

Dimensioning objects in Draw and then displaying the dimensions makes drawing look more like an engineering drawing. When dimensions are created, they are automatically placed on the **Dimension Lines** layer.

Dimensioning objects

- 1) Dimension an object using one of the following methods:
 - Click on the triangle ▼ next to **Lines and Arrows** on the Drawing toolbar to open the Lines and Arrows pop-up toolbar (Figure 286), then click on **Dimension Line** and the cursor changes shape, for example a cross.
 - Click on **Dimension Line** in the **Lines and Arrows** panel in the Shapes deck on the Sidebar (Figure 287) and the cursor changes shape, for example a cross.

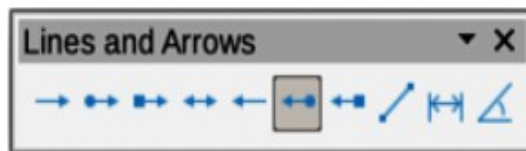

Figure 286: Lines and Arrows sub-toolbar

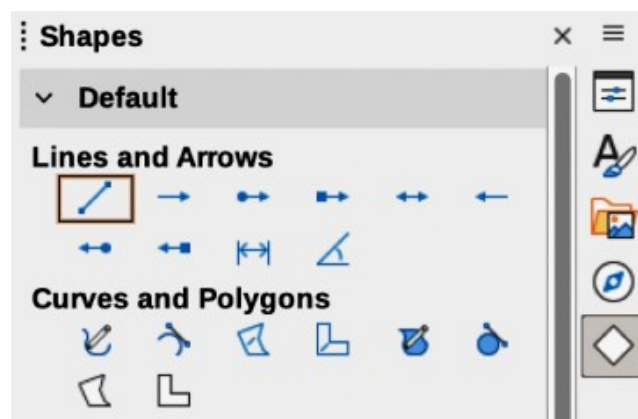

Figure 287: Lines and Arrows panel in Shapes deck on Sidebar

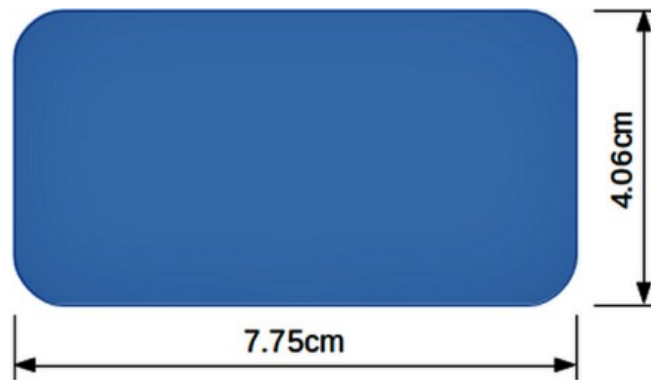

Figure 288: Example of a dimensioned object

- 2) Position the cursor at one corner of the object, then click and drag the cursor to draw the dimension line. To restrict drawing the dimension line in the horizontal or vertical direction, press and hold the *Shift* key while dragging the cursor.
- 3) Release the cursor when the end of the dimension line is reached and the dimension line is drawn. The dimension is automatically added (as shown by the example in Figure 288) and the dimension line is also placed automatically on the **Dimension Lines** layer.
- 4) To edit the text of the dimension, double-click on an unselected dimension line to enter text edit mode and make any necessary changes. Click outside the dimension line to save the changes.
- 5) To configure the dimension line, see “Configuring dimensioning” on page 292.

✓ Note

After editing the dimension text, entering text and then deleting text, save the drawing and reopen it to enable automatic measurements for dimensioning.

Configuring dimensioning

Drawing object styles

- 1) Open the Graphics Styles dialog (Figure 289) using one of the following methods:
 - Go to **Format > Styles > Edit Style** on the Menu bar.

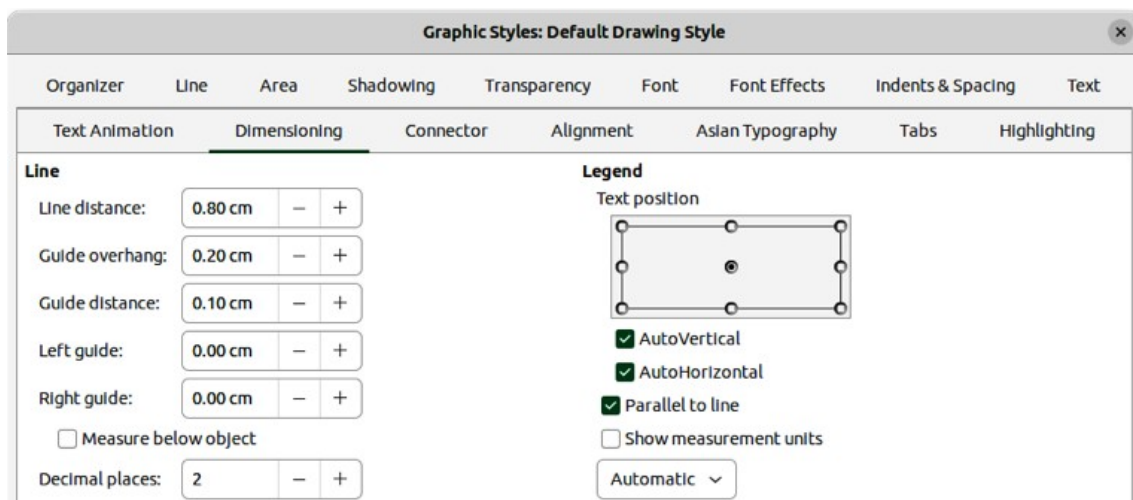

Figure 289: Graphic Styles dialog — Dimensioning page

- Use the keyboard shortcut *F11* (macOS $\text{⌘}+T$) to open the Styles deck on the Sidebar, then right-click on a style and select **Modify** from the context menu.
 - Click on **Styles** on the Sidebar to open the Styles deck, then right-click on a style and select **Modify** from the context menu.
- 2) Click on **Dimensioning** to open the **Dimensioning** page in the dialog.
 - 3) Make the changes required to dimensioning using the various options in the **Line** and **Legend** sections on the **Dimensioning** page.
 - 4) Click **OK** to save the changes and close the Graphic Styles dialog.
 - 5) To reset the dimensioning options to the default properties of the template, open the Graphics Style dialog, then click on **Standard**.

Dimension line dialog

- 1) Draw a dimension line. See “Dimensioning objects” on page 291 for more information.
- 2) Right-click on the dimension line and select **Dimensions** from the context menu to open the Dimension line dialog (Figure 290).
- 3) Make the required changes for dimensioning using the various options in the Dimension line dialog.
- 4) Click **OK** to save the changes and close the Dimension line dialog.

Dimensioning options

The dimensioning options in the **Dimensions** page in the Graphics Style dialog and the Dimension Line dialog are as follows. The preview in the dialogs changes as the following options are changed showing how the dimension line appears in a drawing.

Line

Sets distances between the dimension line, guides and the object.

Line distance

Specifies distance between the dimension line and the object or baseline. A minimum of -10mm to a maximum of 10mm can be entered in the text box. The lower the value, the closer the dimension line is to the object or baseline.

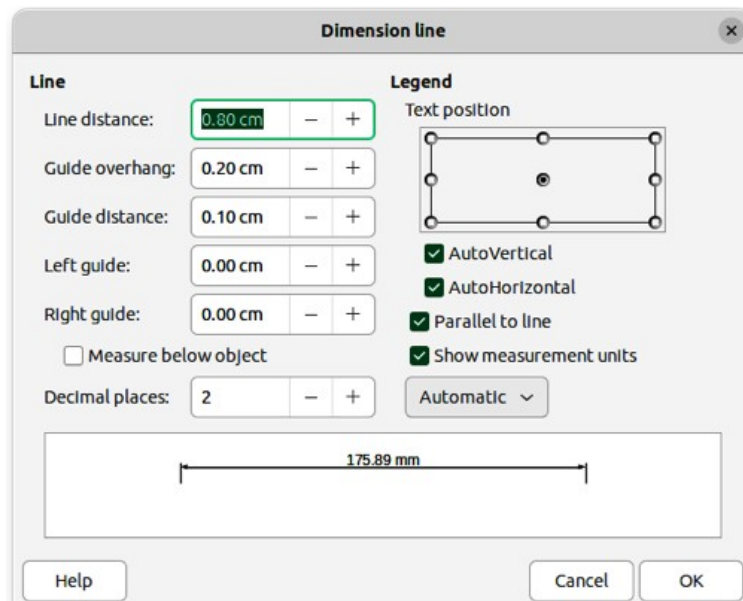

Figure 290: Dimension Line dialog

Guide overhang

Specifies distance the guide extends above or below the dimension line. A minimum of -10mm to a maximum of 10mm can be entered in the text box. Positive values cause the guide overhang to extend above the dimension line. Negative values cause the guide overhang to be below the baseline.

Guide distance

Specifies length of the right and left guides below the dimension line toward the object. A minimum of -10mm to a maximum of 10mm can be entered in the text box. Positive values extend the guides above the baseline and further away from the object. Negative values extend the guides below the baseline and closer to the object.

Left guide

Specifies length of the left guide starting at the dimension line. A minimum of -10mm to a maximum of 10mm can be entered in the text box. Positive values extend the guide below the dimension line toward the object. Negative values move the guide away from the object.

Right guide

Specifies length of the right guide starting at the dimension line. A minimum of -10mm to a maximum of 10mm can be entered in the text box. Positive values extend the guide below the dimension line toward the object. Negative values move the guide away from the object.

Measure below object

Reverses positions and lengths of the dimension line and guides set in **Line** options.

Decimal places

Specifies number of decimal places used for the display of line properties.

Legend

Sets the properties of the dimension text.

Text position

Determines position of the dimension text to the dimension line and guides. The *AutoVertical* and *AutoHorizontal* must be deselected before a text position can be assigned.

AutoVertical

Determines optimal vertical position for the dimension text.

AutoHorizontal

Determines optimal horizontal position for the dimension text.

Parallel to line

Displays, when selected, text parallel to the dimension line or, when deselected, at 90 degrees to the dimension line.

Show measurement units

Shows or hides dimension measurement units. A measurement unit is selected from the drop-down list.



Note

The dimensioning options are linked with the current drawing. Any changes made apply only to the current drawing. New drawings start with the standard properties of Draw. If the dimensioning options are to be used for future drawings, save the drawing as a template.

Tip

When dimensioning objects, it is recommended to use the zoom function, guide lines and snap functions so dimension lines can be accurately placed on an object. See Chapter 3, Working with Objects and Object Points for more information.

Drawing to scale

In Draw, the predefined **Workspace** drawing area is normally Letter or A4 page size, depending on the computer setup and the default printer connected to the computer. However, depending on the actual size of the drawn objects, it is often convenient to reduce or enlarge the drawing by scaling (for example 1:10 or 2:1).

Note

If drawing to scale, dimension configuration values in the Graphics Style dialog and the Dimension Line dialog are also to scale. For example, a value of 10mm in the dialog results in a dimension value of 300mm if the scale has been set to 1:30.

Specify the drawing scale by going to **Tools > Options > LibreOffice Draw > General** (macOS **LibreOffice > Preferences > LibreOffice Draw > General**) to open the Options dialog (Figure 291), then select a value from the **Scale** drop-down list. The default setting for this option is 1:1. When a change is made to the drawing scale, it is reflected in the rulers at the top and left side of the Workspace.

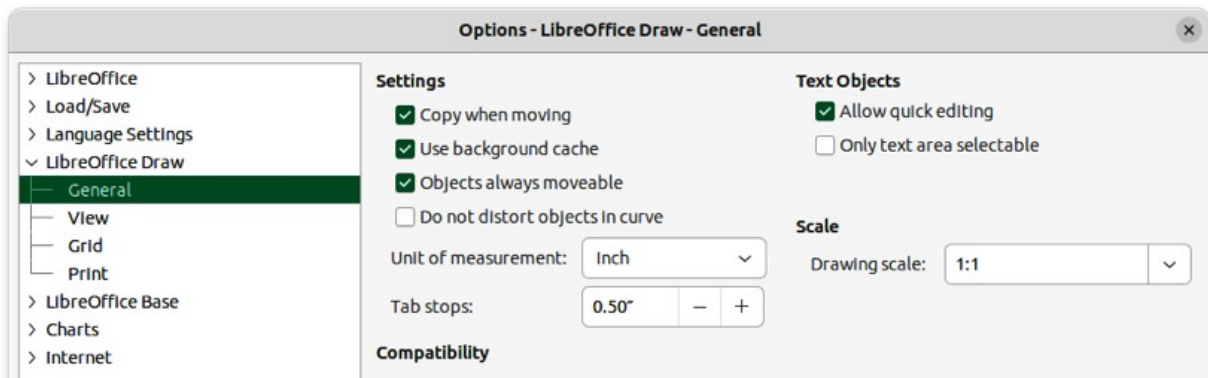

Figure 291: Options LibreOffice Draw dialog — General page

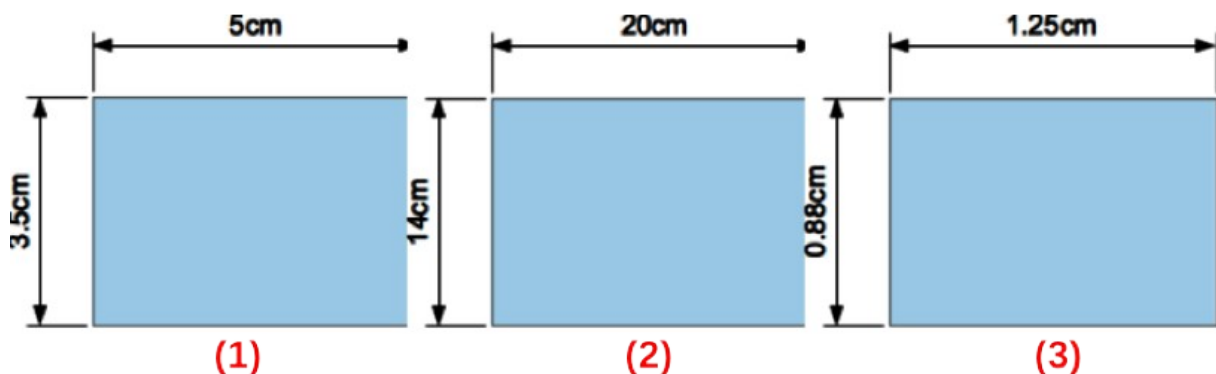

Figure 292: Example of drawing to scale

- 1) Drawing scale 1:1
- 2) Drawing scale 1:4
- 3) Drawing scale 4:1

Any change in the drawing scale has no effect on the basic drawing operations. Draw automatically calculates the necessary values (for example, dimension lines). The spacing of the grid points is independent of drawing scale as the grid is only a visual drawing aid and not a drawing element.

An increase in scale (for example 1:4) allows large objects to be drawn that would not fit into the paper size for a drawing. A decrease in drawing scale (for example 4:1) allows small objects to be drawn accurately at an increased size and make them easier to understand. Examples of drawing to scale are shown in Figure 292 where all three rectangles are the same size in the drawing.

- **Left rectangle** — drawn at the default 1:1 scale and dimensioned.
- **Center rectangle** — drawing scale changed to 1:4 and the dimensions were automatically increased by Draw to reflect the decrease in scale.
- **Right rectangle** — drawing scale changed to 4:1 and the dimensions were automatically decreased by Draw to reflect the increase in scale.

Multiple views of a drawing

Several views of the same drawing can be opened and used in LibreOffice Draw. These views are displayed in separate windows and are useful in displaying views of the drawing, for example, master page and normal page open at the same time. However, make sure that the correct view is active when saving a drawing.

To open a new window displaying the same drawing file, go to **Window > New Window** on the Menu bar. A change to the drawing in one window is immediately reflected in other open windows.

The filename in the title bar for each open window is automatically numbered as shown by the example in Figure 293. If other LibreOffice documents are open at the same time, this windows list includes all the open documents. The active window has a marker by its filename in the list.

Switch between windows by clicking on a name in the list, or by clicking on the window itself if it is visible on the display.

Use one of the following methods to close a window:

- Go to **Window > Close Window** on the Menu bar.
- Use the keyboard shortcut *Ctrl+W* (macOS *⌘+W*).
- Click on **Close** in the Menu bar of the window.



Figure 293: Example of multiple windows open in Draw

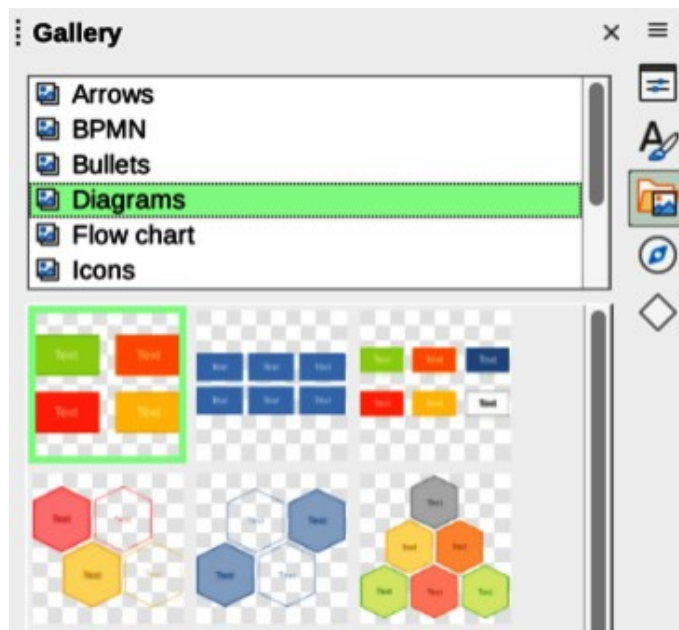

Figure 294: Gallery deck in Sidebar — Icon view

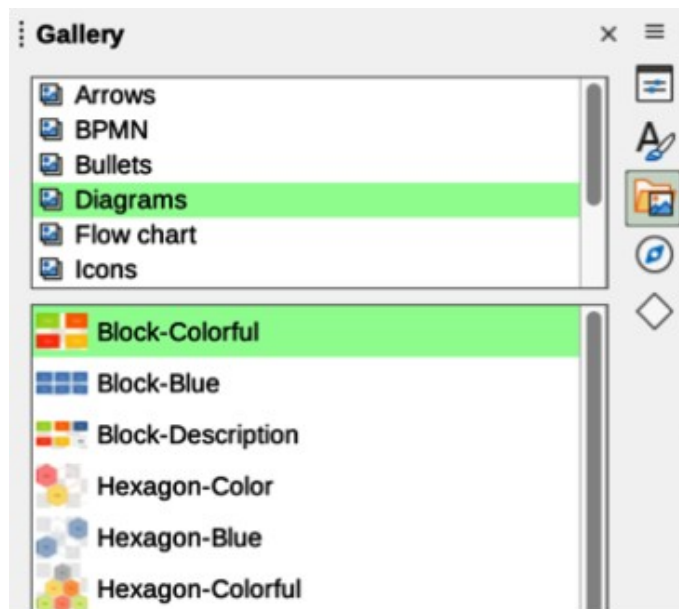

Figure 295: Gallery deck in Sidebar — Detailed view

Gallery

Draw includes several images in the Gallery. These images are grouped into themes (for example **Arrows**, **Bullets**, **Diagrams**, and so on) and are listed in alphabetical order. Click on a theme and its images are displayed below the theme list.

- To display an icon view of the images in the Gallery deck (Figure 294), click on **Icon View** at the bottom left of the Sidebar.
- To display an alphabetical view of the images in the Gallery deck (Figure 295), click on **Detailed View** at the bottom left of the Sidebar.

Using the Gallery

- 1) Click on **Gallery** on the Sidebar, or go to **Insert > Media > Gallery** on the Menu bar.
- 2) Select a theme from the available options.
- 3) Use one of the following methods to place an image into a drawing:
 - Click on an image in the Gallery deck and drag the image into a drawing.
 - Right-click on an image and select **Insert** from the context menu. The image is placed at the center of a drawing.
 - Right-click on an image and select **Copy** from the context menu then paste the image into the drawing. The image is placed at the center of the drawing.
- 4) Edit the gallery image to the drawing requirements. For more information on editing images and pictures, see Chapter 6, Editing Pictures.

Creating themes and adding images

- 1) Open the Gallery deck on the Sidebar.
- 2) Click on **New** at the bottom right of the Gallery deck to open the Properties of New Theme dialog (Figure 296).
- 3) On the **General** page, enter a name for the theme in the text box.

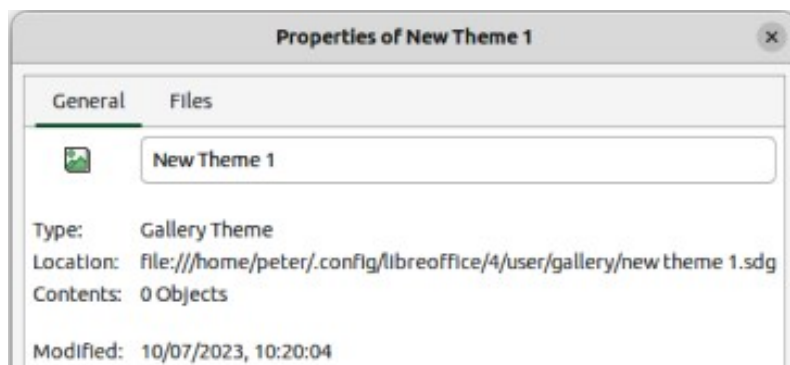

Figure 296: Properties New Theme dialog — General page

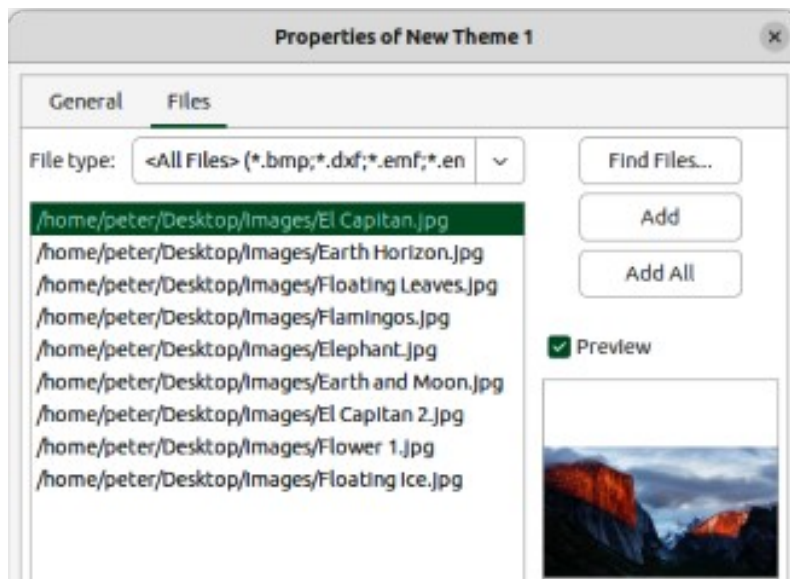

Figure 297: Properties of New Theme dialog — Files page

- 4) Click on **Files** to open the **Files** page (Figure 297).
- 5) Click on **Find Files** to open a Select Path dialog.
- 6) Navigate to the folder that contains the images required and click **OK** to select the folder and the Select Path dialog closes. A list of files contained in the folder now appear in the **Files** page as shown by the example in Figure 297.
- 7) If necessary, select the file format required for the images from the options available in the drop-down list. By default, all formats for image files are selected.
- 8) If required, click on **Preview** to display each selected image file.
- 9) Select the files required for the new theme. If necessary, press the *Ctrl* key (macOS ⌘) to select multiple files.
- 10) Click on **Add**. The selected files disappear from the file list and the images appear in the Gallery.
- 11) If all the files in the list are to be added, click **Add All**. All files disappear from the list and the images appear in the Gallery.
- 12) Click **OK** when finished adding files and close the Properties of New Theme dialog. The name of the new theme appears in the Gallery deck.

Note

If a Draw object is added to a theme, the object loses its connection to Draw graphic styles and all properties are set as direct formatting.

Deleting gallery themes and images

- 1) Right-click on a theme, or image in the Gallery and select **Delete** from the context menu.
- 2) Click on **Yes** in the confirmation dialog and the theme, or image is deleted from the Gallery.

Notes

Only themes and images that have been added to Draw can be deleted. Themes and images included with the LibreOffice installation cannot be deleted.

An image is a linked file and only the link is deleted from the Gallery. The original image file is not deleted.

Updating the Gallery

All images in the Gallery are linked files. Occasionally, it is beneficial to update a theme that has been added to Draw to make sure that all files are still accessible. Right-click on a theme that has at least one file added to the theme and select **Update** from the context menu.

Renaming themes

To rename a theme that has been added to Draw, right-click on the theme name and select **Rename** from the context menu.

Note

Only themes and images that have added to Draw can be renamed. Themes and images included with the LibreOffice installation cannot be renamed.

Colors

Draw (like all LibreOffice components) uses colors grouped into color palettes. Colors can be created to suit drawing requirements. All custom colors created are placed in the custom color palette. The following explains the color models that are used to create a custom color.

Red, Green, Blue (RGB)

The RGB color model is based on the additive color model of light waves and is designed for electronic displays and computers. This means, the more color added, the closer a color moves towards white. RGB is created using scales from 0 to 255. When black is used, the values are R=0, G=0, and B=0. When white is used, the values are R=255, G=255, and B=255. LibreOffice uses the RGB color model internally for printing in all LibreOffice modules.

Cyan, Magenta, Yellow, Key (Black) (CMYK)

It is a subtractive color model where colors are subtracted to change, or create a color. It is mainly used in printing, which is why printer ink cartridges are labeled CMYK. CMYK works on a scale of 0 to 100. When black is used, the values are C=100, M=100, Y=100, and K=100. When white is used, the values are C=0, M=0, Y=0, and K=0.

Hue, Saturation, Brightness (HSB)

HSB values are an alternative representation of the RGB color model and were designed to be more closely aligned with the way human vision perceives color-making attributes. Use HSB values to fine tune any custom colors that are created.

Tip

More information on color models and color values can be found at https://en.wikipedia.org/wiki/Color_model.

Changing colors in objects or lines

When changing colors in objects, color palettes are used to select colors. These color palettes are installed with LibreOffice and are used in all the LibreOffice modules. Using color palettes is similar across all types of objects, but accessing the color palettes does vary according to the type of object selected.

Color Bar

Although LibreOffice includes tools to precisely specify a color, it also includes a Color Bar (Figure 300) for quickly changing color in object area fills, borders, or lines.

- 1) Select an object in the drawing.

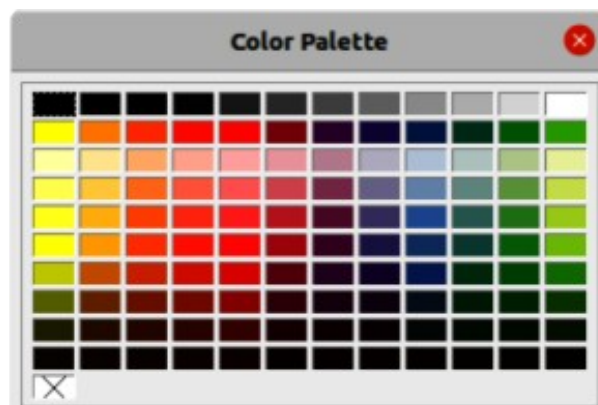

Figure 298: Color Bar (Color Palette)

- 2) Go to **View > Color Bar** on the Menu bar to open the Color Bar. When the Color Bar opens, it is labeled Color Palette.
- 3) Left click on a color to change the area fill color, or right-click on a color to change the border or line color of a selected object.
- 4) Left click on the X box in the bottom left corner of the Color Bar to remove the color from an object fill, or right-click on the X box in the bottom left corner of the Color Bar to remove the color from an object border,
- 5) To close the Color Bar, go to **View > Color Bar** on the Menu bar and deselect **Color Bar**.

✓ Note

The colors available in the Color Bar are from the Standard color palette that is part of the LibreOffice installation.

Area dialog

- 1) Select an object in the drawing.
- 2) Open the Area dialog (Figure 299) using one of the following methods:
 - Go to **Format > Area** on the Menu bar.
 - Right-click on the object and select **Area** from the context menu.
- 3) Click on **Area**, then click on **Color** to open the **Color** page.
- 4) In **Colors**, select a color palette from the *Palette* drop-down list.
- 5) Click on a color from the ones displayed in the color palette, or select a color that has been previously used from *Recent Colors*.
- 6) Click **OK** to save the changes and close the Area dialog. The selected fill color appears in the selected object.

Area panel on the Sidebar

- 1) Select an object in the drawing.
- 2) Open the **Area** panel in the Properties deck on the Sidebar (Figure 300).
- 3) Select *Color* from the **Fill** drop-down list.



Figure 299: Area dialog — Color page

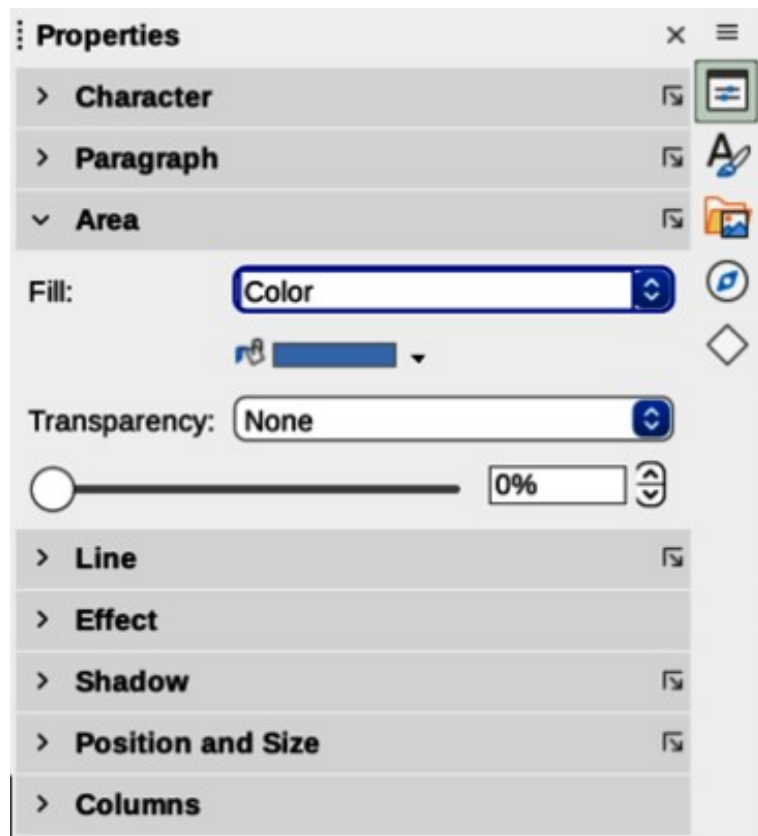

Figure 300: Area panel in Properties deck on Sidebar

- 4) Click on the triangle ▼ on the right of **Fill Color** to open the palette last used.
- 5) If necessary, select a color palette from the available palettes in the drop-down list.
- 6) Click on a color from the colors displayed in the color palette, or select a color that has been previously used from those displayed in *Recent*. The color palette closes and the selected fill color is applied to the object.

Fill Color on the Line and Filling or Drawing toolbars

- 1) Select an object in the drawing.
- 2) Click on the triangle ▼ to the right of **Fill Color** on the Line and Filling toolbar, or the Draw toolbar to open the last color palette used.
- 3) Click on a color from the colors displayed in the color palette, or select a color that has been previously used from those displayed in *Recent*. The color palette closes and the selected fill color is applied to the selected object

Line dialog

- 1) Select a line, or object in the drawing.
- 2) Open the Line dialog (Figure 301) using one of the following methods:
 - Go to **Format > Line** on the Menu bar.
 - Right-click on the line or object and select **Line** from the context menu.
- 3) Click on **Line** to open the **Line** page.
- 4) Click on the triangle ▼ to the right of **Color** to open the last color palette used.
- 5) Select a color palette to use from the available palettes in the drop-down list.

- 6) Click on a color from the colors displayed in the color palette, or select a color that has been previously used from those displayed in *Recent*. The color palette closes and the selected line color is applied to the line or object border.
- 7) Click **OK** to save the color change and close the Line dialog.

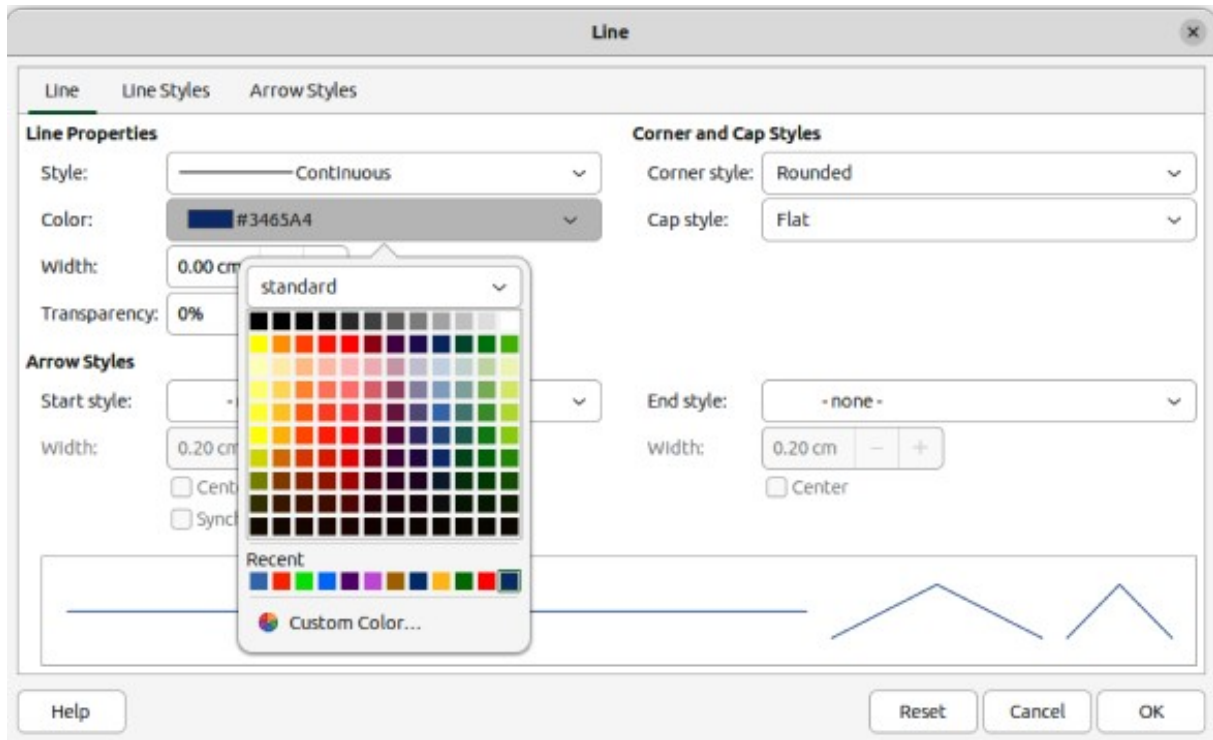

Figure 301: Line dialog — Line page

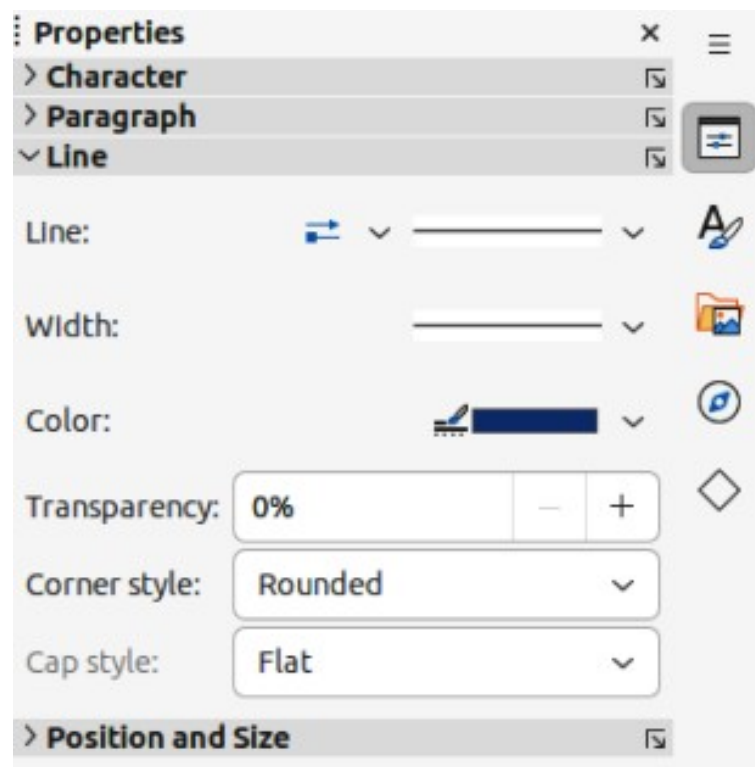

Figure 302: Line panel in Properties deck on Sidebar

Line panel on the Sidebar

- 1) Select a line, or object in the drawing.
- 2) Open the **Line** panel in the Properties deck on the Sidebar (Figure 302).
- 3) Click on the triangle ▼ to the right of **Color** to open the palette last used.
- 4) Select a color palette to use from the available palettes in the drop-down list.
- 5) Click on a color from the colors displayed in the color palette, or select a color that has been previously used from those displayed in *Recent*. The color palette closes and the selected line color is applied to the line or object border.

Line Color on the Line and Filling or Drawing toolbars

- 1) Select a line, or object in the drawing.
- 2) Click on the triangle ▼ to the right of **Line Color** on the Line and Filling toolbar, or the Draw toolbar to open the last color palette used.
- 3) Select a color palette to use from the available palettes in the drop-down list.
- 4) Click on a color from the colors displayed in the color palette, or select a color that has been previously used from those displayed in *Recent*. The color palette closes and the selected line color is applied to the line or object border.

Changing text color

Changing text color is very similar to changing the color of an area fill, object border, or line. The Text Formatting toolbar automatically opens and replaces the Line and Filling toolbar when text is selected in a drawing. If the Text Formatting toolbar does not open, go to **View > Toolbars** on the Menu bar and select **Text Formatting**.

Character dialog

- 1) Select a text box, or switch on text mode for a Draw object.
- 2) Highlight the text characters where the text color is going to be changed.
- 3) Open the Character dialog (Figure 303) using one of the following methods:
 - Go to **Format > Character** on the Menu bar.
 - Right-click on the highlighted text and select **Character** from the context menu.
- 4) Click on **Font Effects** to open the **Font Effects** page.
- 5) Click on the triangle ▼ to the right of **Font Color** to open the last color palette used.
- 6) Select a color palette to use from the available palettes in the drop-down list.
- 7) Click on a color from the colors displayed in the color palette, or select a color that has been previously used from those displayed in *Recent*. The color palette closes and the selected color is applied to the selected text.
- 8) Click **OK** to save the color change and close the Character dialog.

Character panel on the Sidebar

- 1) Select a text box, or switch on text mode for a Draw object.
- 2) Highlight the text characters where the text color is going to be changed.
- 3) Open the **Character** panel in the Properties deck on the Sidebar (Figure 304).
- 4) Click on the triangle ▼ to the right of **Font Color** to open the color palette last used.
- 5) Select a color palette to use from the available palettes in the drop-down list.

- 6) Click on a color from the colors displayed in the color palette, or select a color that has been previously used from those displayed in *Recent*. The color palette closes and the selected color is applied to the selected text.

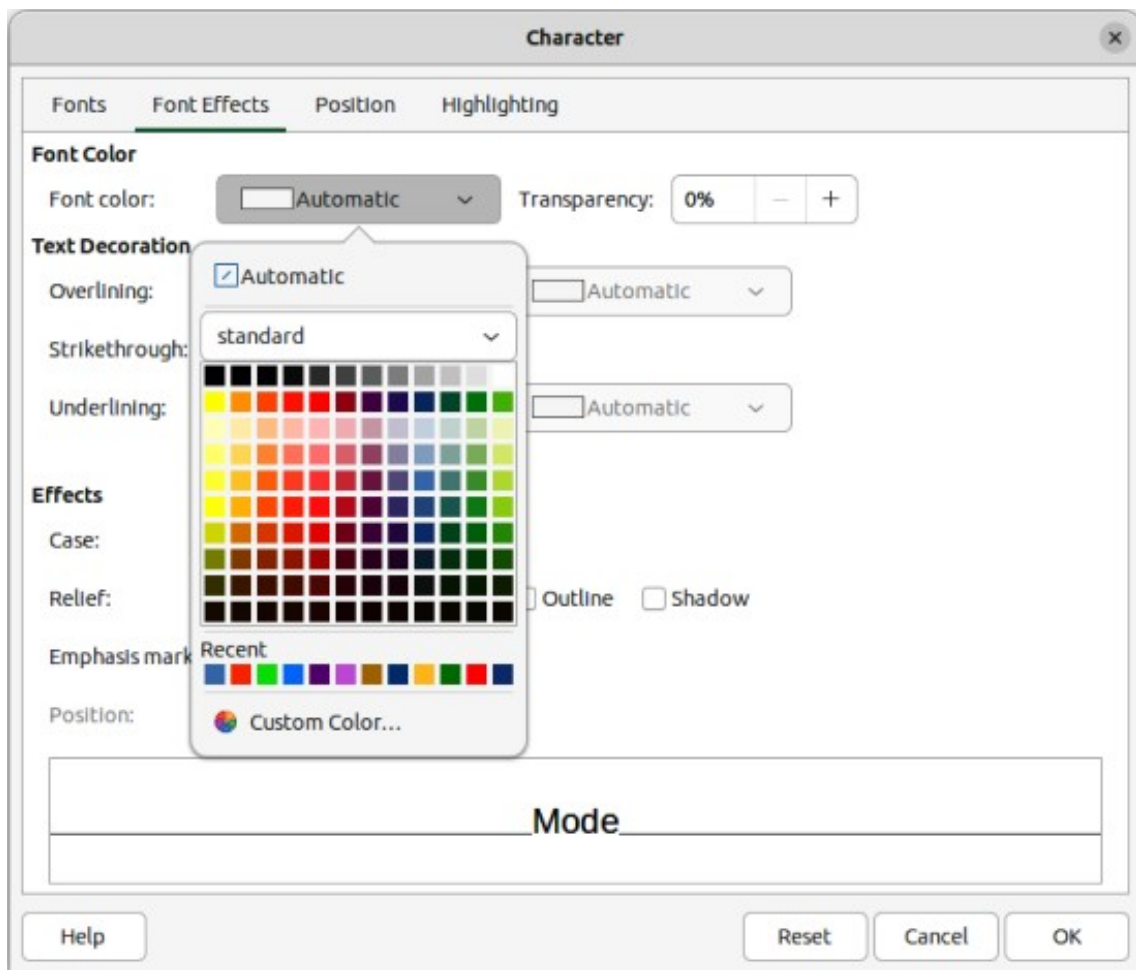

Figure 303: Character dialog — Font Effects page

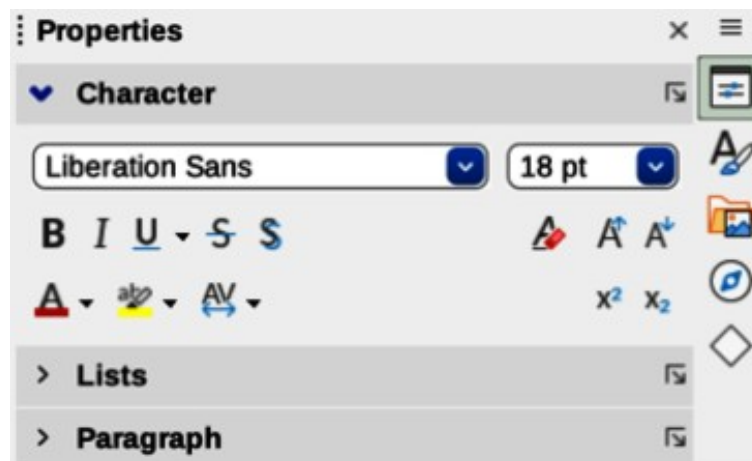

Figure 304: Character panel in Properties deck on Sidebar

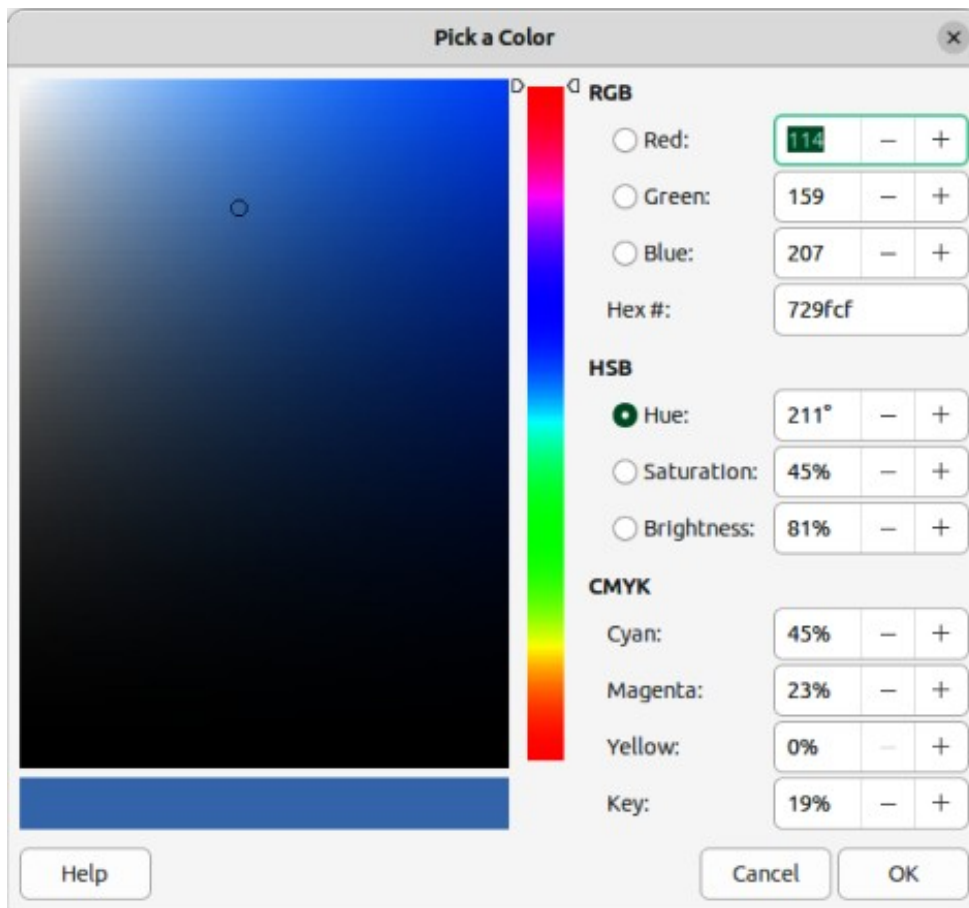

Figure 305: Pick a Color dialog

Creating colors

Using Pick a Color dialog

- 1) Select an object, or text and open the Pick a Color dialog (Figure 305) using one of the following methods:
 - Open the Area dialog, then click on **Color** to open the **Color** page and click on **Pick**.
 - Open the **Area** panel in Properties deck on the Sidebar, click on the triangle ▼ to the right of **Fill Color** to open the color palette and click on **Custom Color** at the bottom of the color palette.
 - Open the Line dialog, then open a color palette in **Color** and click on **Custom Color** at the bottom of the color palette.
 - Open the **Line** panel in Properties deck on the Sidebar, click on the triangle ▼ to the right of **Line Color** to open the color palette and click on **Custom Color** at the bottom of the color palette.
 - Open the **Character** dialog, then open a color palette in **Font color** and click on **Custom Color** at the bottom of the color palette.
 - Open the **Character** panel in Properties deck on the Sidebar, click on the triangle ▼ to the right of **Font Color** to open the color palette and click on **Custom Color** at the bottom of the color palette.
- 2) Select a color range on the vertical color bar in the Pick a Color dialog that approximately matches the custom color being created.

- 3) Click and drag the small target circle in the color box until the color matches the custom color required. The values for RGB, HSB and CMYK change as the small target circle is dragged around the color box helping to create the exact color, if the color values are known.
- 4) Alternatively, if the color values, or hex number, are known, enter these values in the appropriate text box. The values in all the text boxes change to match the new values. For example, enter HSB values, the RGB, CMYK and Hex values also change to match.
- 5) Click **OK** to save the changes and close the Pick a Color dialog.

Notes

When using the Line or Character dialog to open the Pick a Color dialog, the custom color created cannot be saved into the **Custom Palette**, or renamed with a more meaningful name. The custom color created is named using the hex value that is displayed in the Pick a Color dialog. Only the Area dialog has the ability to rename custom colors and save custom colors into the **Custom Palette**.

LibreOffice uses the RGB color model for printing in color. The RGB values of a selected color are displayed below the preview boxes.

Using Area dialog

- 1) Open the Area dialog and click on **Color** to open the **Color** page.
- 2) In **New**, enter the RGB values or, if known, the Hex value into the text boxes. The color changes in the preview box to match the values entered.
- 3) Alternatively, in **New**, use the minus and plus signs for the RGB values to decrease or increase the values. The color changes in the preview box to match the values entered.
- 4) Click **OK** to change the color and close the Area dialog.

Adding custom colors

- 1) Make sure the Area dialog is open at the **Color** page.
- 2) Select the custom color that is displayed in *Recent Colors*.
- 3) In **Custom Palette**, click on *Add* to open a Name dialog.
- 4) Enter a new name for the color in the text box.
- 5) Click **OK** to save the changes and close the Name dialog. The custom color appears in the **Custom Palette**.
- 6) Click **OK** to close the Area dialog.

Renaming custom colors

Only a custom color can be renamed using the Area dialog as follows:

- 1) Make sure the Area dialog is open at the **Color** page.
- 2) Select the custom color that is displayed in the **Custom Palette**.
- 3) Click on *Add* to open a Name dialog.
- 4) Enter a new name for the color in the text box,
- 5) Click **OK** to save the changes and close the Name dialog. The custom color appears in the **Custom Palette**.
- 6) Click **OK** to close the Area dialog.

✓ Notes

Renaming a custom color does not actually rename the custom color, but adds the custom color to the **Custom Palette** with a new name.

It is important to use a memorable names for custom colors so that they can be easily recognized in the **Custom Palette**. By default, a custom color is given a hex number, which makes it difficult identifying colors when there is more than one custom color.

Deleting custom colors

Only a custom color can be deleted using the Area dialog as follows:

- 1) Make sure the Area dialog is open at the **Color** page.
- 2) Select the custom color that is displayed in the **Custom Palette**.
- 3) Click on **Delete**. There is no confirmation given when deleting custom colors.
- 4) Click **OK** to close the Area dialog.

Bézier curves

In LibreOffice, Bézier² curves can be used in a drawing. A curve is defined by means of a start point, an end point, and, where necessary, control points. For points on the curve the terms Nodes and Anchors are often used. For more information and an explanation of the mathematical background of Bézier curves, see https://en.wikipedia.org/wiki/Bézier_curve.

Bézier curves are very useful for experimenting with the shape and form of curves. In point mode the curve alignment can be changed by dragging the points with the cursor. In the example shown in Figure 306, the curve leaves the start point P0 in the direction of the first control point P1 and arrives at the end point P3 from the direction of the second control point P2. The more distant a control point is from the start or end point, the smaller the curvature at that point.

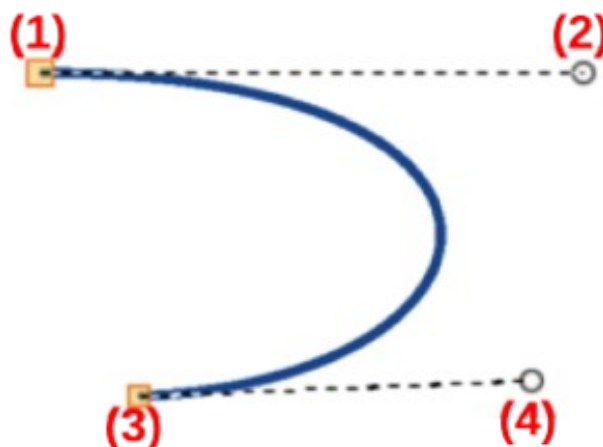

Figure 306: Example of a Bezier curve

- 1) Start point (P0)
- 2) Control point (P1)
- 3) End point (P3)
- 4) Control point (P2)

- 2) Bézier curves were invented by Pierre Bézier, an engineer working with the Renault car manufacturer, who developed the technique in the 1960s. The technology was intended to make modeling the surface of vehicles easier.

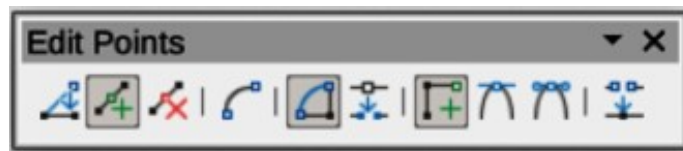

Figure 307: Edit Points toolbar

Drawing Bézier curves

- 1) Click on **Curve** in the **Curves and Polygons** panel in the Shapes deck on the Sidebar, or **Curves and Polygons** on the Drawing toolbar.
- 2) Click at the start point for the curve and drag the cursor to the approximate position of the end point for the curve.
- 3) Release the cursor and drag the end point of the curve to its end position.
- 4) Double-click when the end position of the curve is reached and a curve is drawn. The arc of the curve is determined by the distance dragged to create the end point.
- 5) Switch to points mode using one of the following methods:
 - Go to **Edit > Points** on the Menu bar.
 - If added to the toolbar, click on **Points** on the Drawing toolbar.
 - Use the keyboard shortcut *F8*.
- 6) Open the Edit Points toolbar (Figure 307) using one of the following methods. The Edit Points toolbar does not become visible until a point has been selected on a curve.
 - Go to **View > Toolbars** on the Menu bar and select **Edit Points**.
 - Use the keyboard shortcut *F8*.
 - If added to the toolbar, click on **Points** on the Drawing toolbar.
- 7) Click once on the curve to display the start and end points. The start point of the curve is larger than the end point.
- 8) Click on a start or end point to display the control points. Control points appear at the end of a dashed line connected to the selected point, as shown in Figure 308.
- 9) Click on the control point and drag it to a new position to change the shape of the curve.
- 10) When the shape of the curve is correct, release the mouse button to fix the curve.
- 11) Click anywhere on the workspace to deselect the curve and stop editing points.

Edit Points tools

After the initial opening of the Edit Points toolbar, when an object is selected that has been converted to a curve or polygon, the toolbar is displayed. The tools available on the Edit Points toolbar allow the editing of a Bézier curve and changing of the curve shape. A point on a Bézier curve has to be selected for all the tools on the Edit Points toolbar to become available.

Move Points

Click and drag on a point to move it to another location.

- The curve on both sides of the point follows the movement and changes shape as the selected point changes position.
- Click and drag on the curve between points to move the entire curve without distorting the form.

Insert Points

Activates the insert mode when selected and inserts smooth points onto a curve. Insert mode remains active after inserting points. Select **Move Points** to deactivate insert mode.

- The inserted point can be moved while insert mode is activated.
- If a corner or symmetrical point is required, insert a smooth point first and convert the point to a corner or symmetrical point.

Delete Points

Deletes selected points. If several points are to be deleted, hold down the Shift key whilst selecting points and before clicking on Delete Points.

Convert To Curve

Converts a curve into a straight line or a straight line into a curve (Figure 308).

- Select a single point and the curved segment after the point converts to a straight line, or converts a straight line segment to a curve after the point.
- When converting a segment from a curve to a straight line, each point at each end of the segment becomes a control point similar to the start or end point.
- When converting a segment from a straight line to a curve, each control point at each end of the segment becomes a smooth point.



Figure 308: Example converting curved segment to line

Close Bézier

Closes a freeform line or curve by connecting the start point with the end point creating an object with area fill.

Split Curve

Splits a curve into two or more curves. Select a point or points and click on **Split Curve** to create separate segments of a curve. Deselect the curve, then select a segment to move or edit it.

Corner Point

Converts a selected point into a corner point (Figure 309). Corner points have two movable control points independent from each other allowing a corner to be created in a curve.

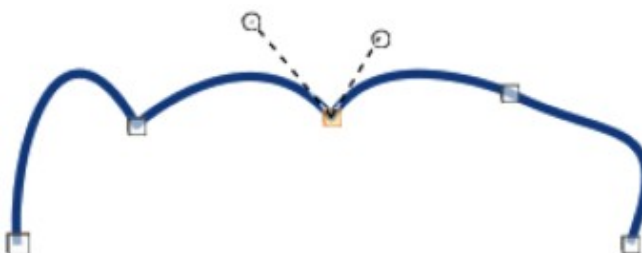

Figure 309: Example of a corner point

Smooth Transition

Converts a corner or symmetrical point into a smooth point (Figure 310). Both control points are parallel aligned and can only move simultaneously. The control points may differ in length, allowing the curvature degree to be varied.



Figure 310: Example of a smooth transition point

Symmetric Transition

Converts a corner point or a smooth point into a symmetrical point (Figure 311). Both control points are parallel aligned having the same length. These control points can only be moved simultaneously and the degree of curvature is the same in both directions.



Figure 311: Example of a symmetric transition point

Eliminate Points

Allows selection of several points before using the **Delete Points** tool. This is useful when deleting a straight line segment to create a complete curve.

Adding comments

Comments in Draw are similar to comments in Writer and Calc. For more information about adding, navigating, and replying to comments, see the *Getting Started Guide*.

Comments in Draw cannot be printed. To reply to a comment in Draw, a new comment has to be added.

- 1) Go to **Insert > Comment** on the Menu bar and a comment box (Figure 312) appears in the upper left-hand corner of a drawing. Draw automatically adds the user name and date at the bottom of the comment and places a comment marker on the drawing page.
- 2) Type or paste a comment into the comment text box.
- 3) To apply basic formatting to the text, right-click on the text and select the formatting option from the context menu.
- 4) To delete a comment, use one of the following methods:
 - Right-click in the comment box and select **Delete** from the context menu.
 - Right-click on the comment marker and select **Delete** from the context menu.
 - Click on the triangle ▼ in the bottom right of the comment box and select **Delete** from the context menu.

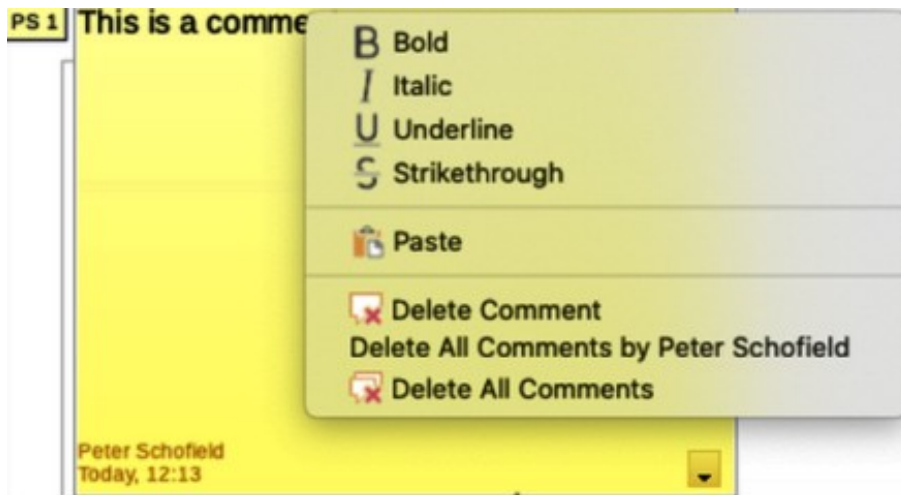

Figure 312: Example comment in Draw

- 5) To move a comment, click on the comment marker and drag it to a new position.
- 6) To hide comments, use one of the following methods:
 - Go to **View** on the Menu bar and deselect **Comments** to hide the comment and the comment marker.
 - Click on the drawing outside of the comment to hide the comment. The comment marker remains visible.
- 7) To show comments, go to **View > Comments** on the Menu bar and click on the comment marker.

✓ Note

For the user name and initials to appear in a comment, enter the user data in **Tools > Options > LibreOffice > User Data** dialog (macOS **LibreOffice > Preferences > LibreOffice > User Data**). If more than one person edits the document, each author is automatically allocated a different background color.

Coordinate system

X and Y axes

The x-axis is the horizontal position of an object and the y-axis is the vertical position of an object. The rulers do not show a minus sign if there are negative coordinates. However, the minus sign for negative coordinates is shown in the position field in the **Status Bar** and the Position and Size dialog.

Workspace

The **Workspace** in Draw is larger than the drawing page. The area outside the drawing page is one page width right and left and a half page above and below the drawing page. The size of the drawing page is indicated by highlighted portions in the horizontal and vertical rulers.

Draw objects can be drawn partly or wholly outside the drawing page and these objects are saved with the drawing. However, when the drawing is printed or exported, any object or portion of an object not on the drawing page is not included. This allows the **Workspace** area around the drawing page to be used for drafts when creating objects.

Object position

The coordinates of objects and snap guides are shown relative to the origin. The default origin for coordinates (0.00/0.00 position) is the top-left corner of the drawing page without margins or the top left corner of the drawing page where the margins intersect. To change the default origin, click and drag the intersection of the rulers in the top left corner of the **Workspace** to the desired position. Guide lines appear as the intersection is dragged from its default origin to its new position. This origin setting is only for the current view and is not saved in the document.

The area inside the default origin is the area used for the grid when the option **Snap to Grid** and **Display Grid** are selected.

To reset the default origin back to its original setting at the top-left corner of the page, double-click in the top-left corner on the **Workspace** where the horizontal and vertical rulers meet.

Accuracy

Draw internally uses integer values in 1/100 mm. Therefore, for example, it is not possible to get an exact position for 1/8 inch. Also, many dialog fields are restricted to two decimals.

To work with the maximum possible accuracy, go to **Tools > Options > LibreOffice Draw > General** (macOS **LibreOffice > Preferences > LibreOffice Draw > General**) and set the option **Unit of measurement** to *Millimeter*. The rulers show metric units after this option has been selected. To use another measurement unit for the rulers, right-click on a ruler and select the measurement unit from the context menu. The horizontal and vertical rulers can have different measurement units.



LibreOffice
Community



Draw Guide 7.5

Chapter 12, User Interface Variants

Introduction

By default, commands and tools used in LibreOffice Draw are grouped in a user interface consisting of cascading menus and toolbars. The functions and use of cascading menus and toolbars are described in the previous chapters of this user guide.

This chapter describes the user interface variants that are available for LibreOffice Draw. A user then has the option to select a user interface that suits their requirements and methods of creating drawings in LibreOffice Draw.

✓ Note

When changing the user interface, the variant can be applied only to LibreOffice Draw, or applied to all the modules in LibreOffice.

Selecting user interface

Select a user interface variant or switch between user interface variants as follows:

- 1) Go to **View > User Interface** on the Menu bar to open the Select Your Preferred User Interface dialog (Figure 313).
- 2) In **UI variants**, select one of the variants. An example of the selected variant is shown in the **Preview** box, along with a short description.
- 3) Click on **Apply to Draw** to apply the selected UI variant to LibreOffice Draw only, or click on **Apply to All** to apply the selected UI variant to all LibreOffice modules. The LibreOffice window changes to match the selected variant.
- 4) Click **Close** to close the dialog.

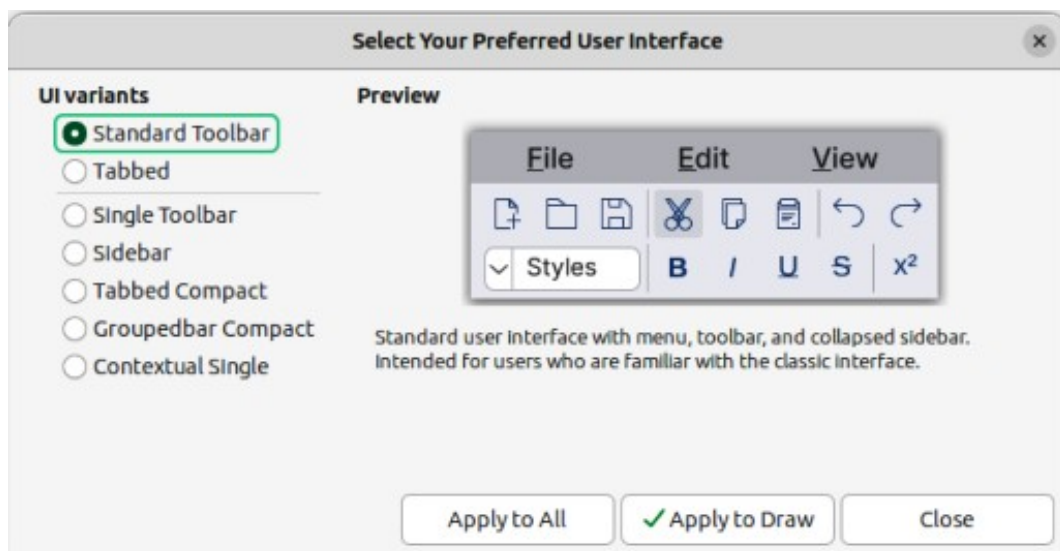

Figure 313: Select Your Preferred User Interface dialog

✓ Note

If the option **Enable experimental features** has been selected in the **Tools > Options > Advanced** dialog (macOS **LibreOffice > Preferences > LibreOffice > Advanced**), several more variants appear in **UI variants**. Being experimental, these variants are not described in this chapter.

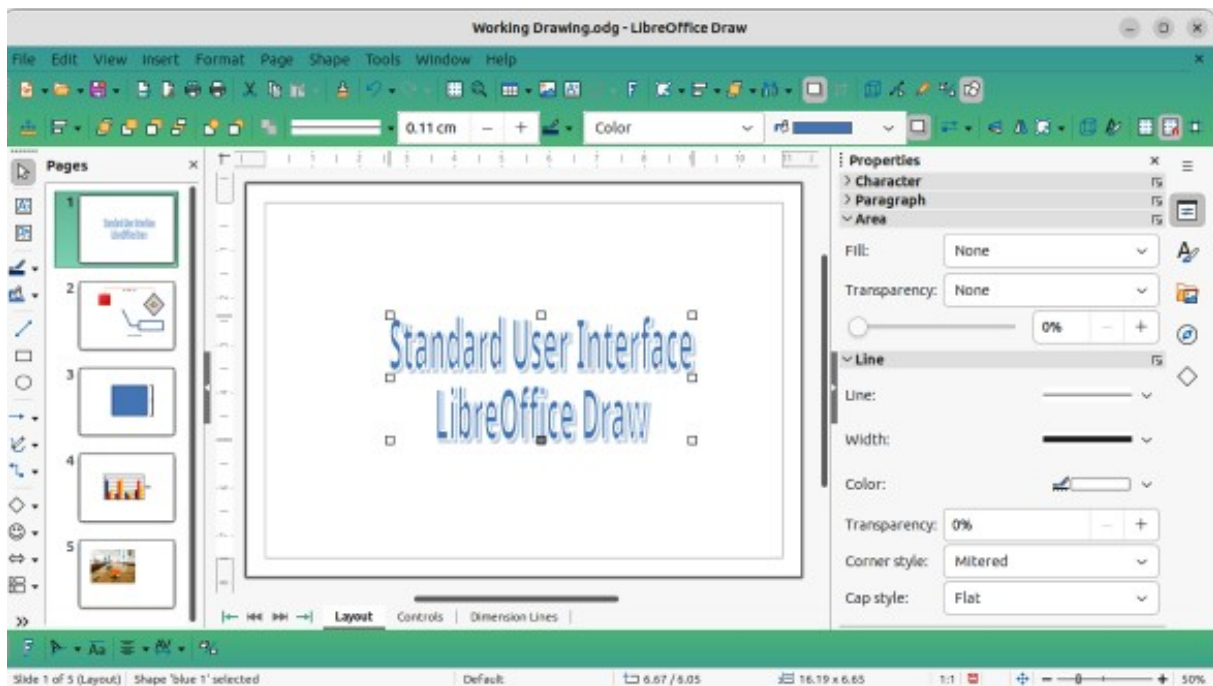

Figure 314: Standard User Interface

Standard Toolbar UI

The **Standard Toolbar** user interface is the default view when LibreOffice is installed and opened for the first time. Figure 314 shows an example of the **Standard Toolbar** user interface for LibreOffice Draw, consisting of the following. For more information, see Chapter 1, Introducing Draw.

- Menu bar at the top of the **Workspace**.
- Standard toolbar positioned below the Menu bar.
- Line and Filling toolbar positioned below the Standard toolbar.
- Drawing toolbar positioned vertically on the left of the **Workspace**.
- Sidebar positioned on the right of the **Workspace**.

Tabbed UI

The **Tabbed** user interface (Figure 315) provides a user interface similar to proprietary office applications, for example Microsoft Office. This user interface is divided into tabs, with each tab displaying a set of tools grouped by context. The context changes depending on the object selected and the LibreOffice module being used.

It includes a Menu bar, a Tab bar, and tool icons grouped in context normally used in LibreOffice Draw. If the tool icons on a tab page do not fit into the width of the Draw window, a double chevron >> appears at the right end of the row. Click on the double chevron >> to display the remaining tool icons.

On Windows and Linux operating systems, the Menu bar can be hidden or displayed by clicking on **Menubar** at the left end of the Tab bar.

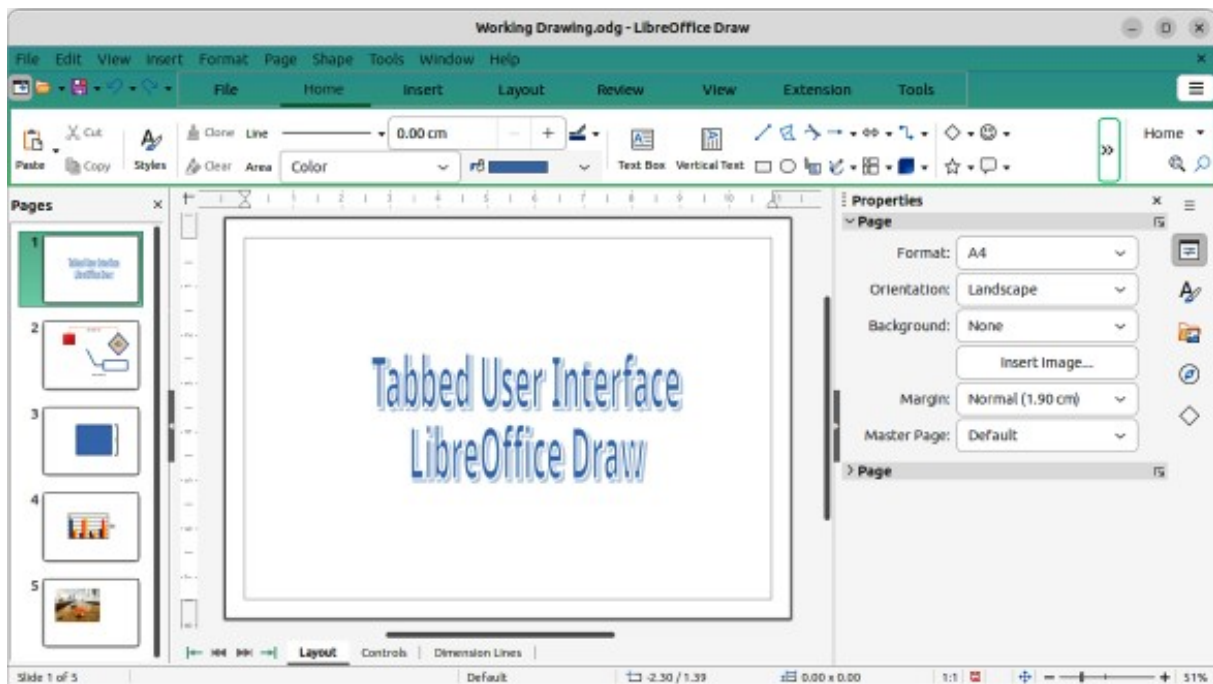

Figure 315: Tabbed User Interface

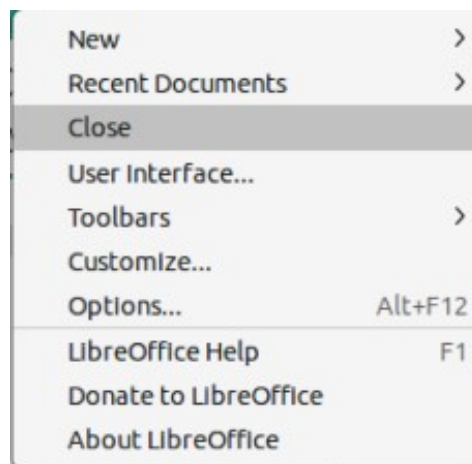

Figure 316: Tabbed UI Quick Menu

On the right of the Tab bar, a **Quick menu** (≡) (Figure 316) gives access to some commonly used commands and links. Some of the **Quick menu** items have submenus, indicated by a triangle ► or chevron > on the right. The **Quick menu** is the same for all tabs.

On the left of the Tab bar, some commonly used tools are available – **Menu bar**; **Open (Ctrl+O)**; **Save (Ctrl+S)**; **Undo (Ctrl+Z)**; **Redo (Ctrl+Y)**.

The Tabbed user interface is customized using the **Notebookbar** page of the **Customize** dialog (Figure 318) to show or hide the individual tools on the various tabs. Go to **Tools > Customize** on the Menu bar to open the **Customize** dialog. For more information on customization of LibreOffice, see the *Getting Started Guide* and the *Writer Guide*.

✓ Note

When using the Tabbed user interface, the toolbars are removed from view. If it is necessary, toolbars can be opened using **View > Toolbars** on the Menu bar or **Quick menu (≡) > Toolbars**.

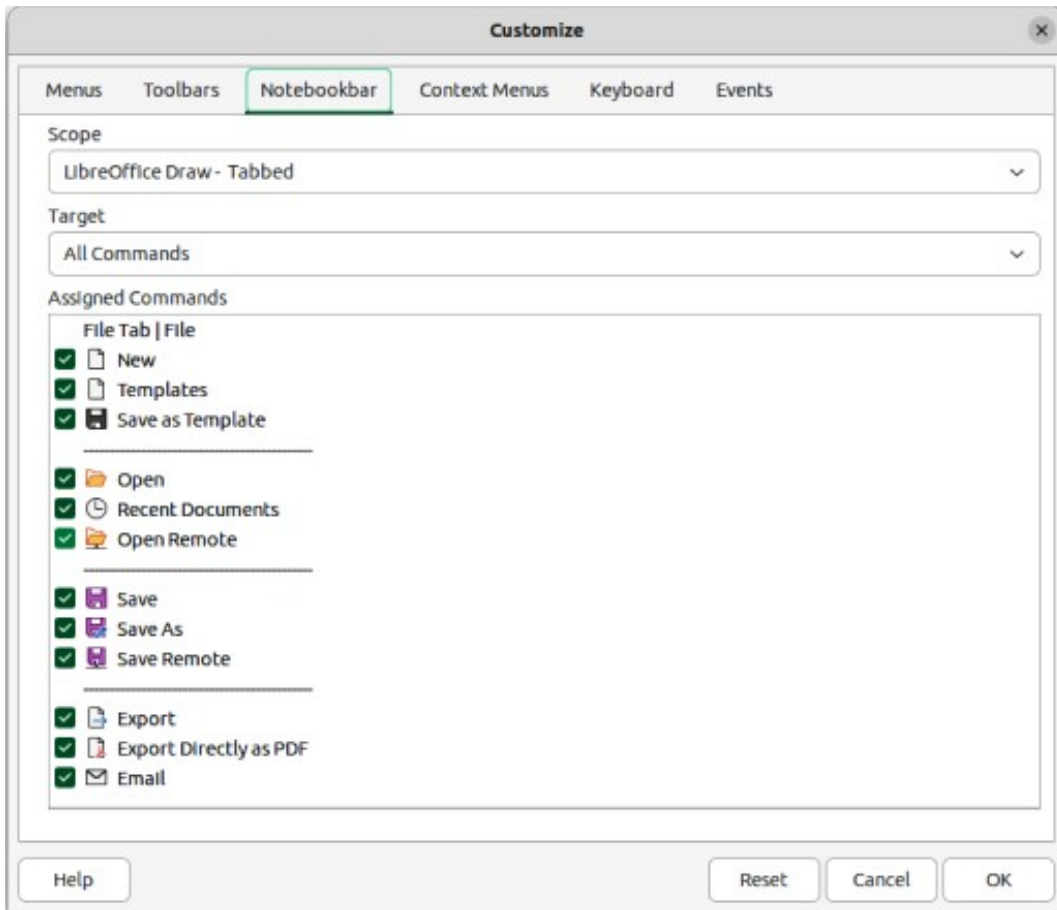

Figure 317: Customize dialog — Notebookbar page

Fixed tabs

File tab

The **File** tab (Figure Error: Reference source not found) provides tools and commands to create new documents and manage existing documents. At right end of the **File** tab has two menus:

- **File** menu providing the same commands as the tools available on the tab.
- **Help** menu providing links to a variety of resources.

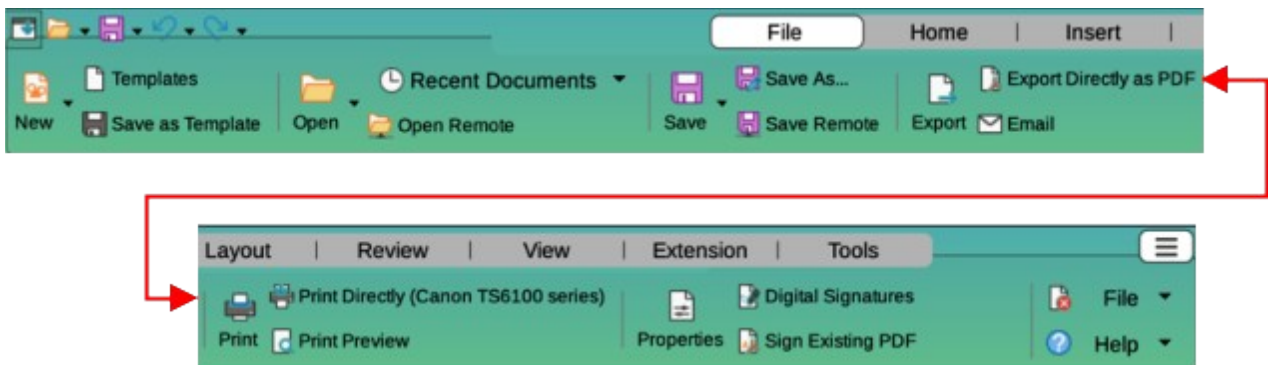

Figure 318: Tabbed User Interface — File tab

Home tab

The **Home** tab (Figure 319) provides tools and commands for cutting, copying, pasting, inserting, and formatting all types of objects such as images, tables, charts, text, and so on. Also, drawing styles can be applied and updated to match drawing requirements. The right end of the **Home** tab provides additional commands that are not available on the tab.

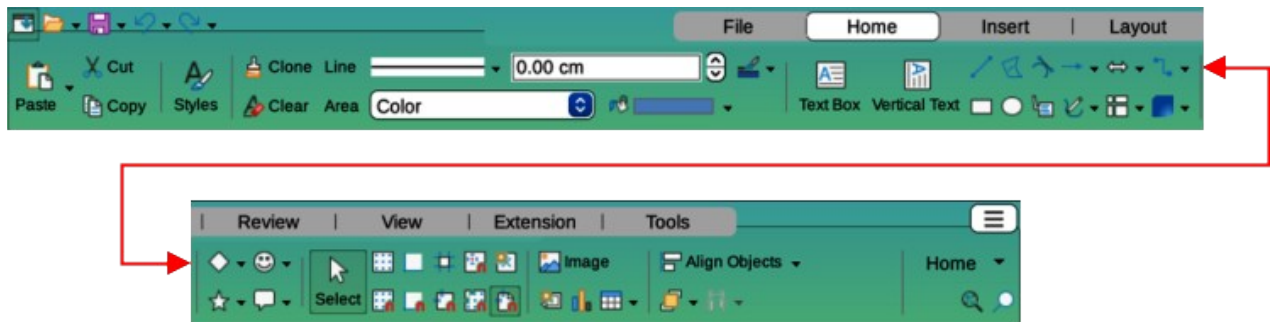

Figure 319: Tabbed User Interface — Home tab

Insert tab

The **Insert** tab (Figure 320) provides tools and commands for inserting many types of objects such as images, tables, charts, and so on. The **Insert** menu at the right end of the **Insert** tab provides some of the same tools and commands.

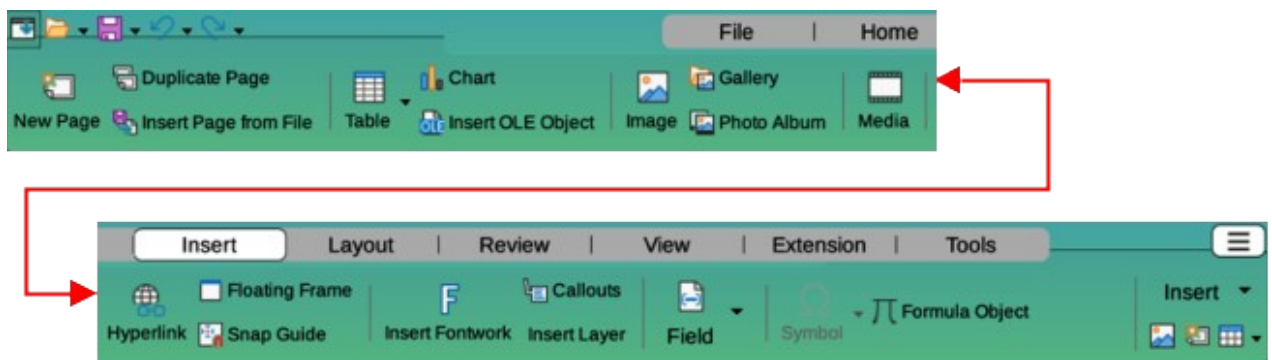

Figure 320: Tabbed User Interface — Insert tab

Layout tab

The **Layout** tab (Figure Error: Reference source not found) provides tools and commands for creating a drawing layout. The **Layout** menu at the right end of the **Layout** tab provides some of the same tools and commands.

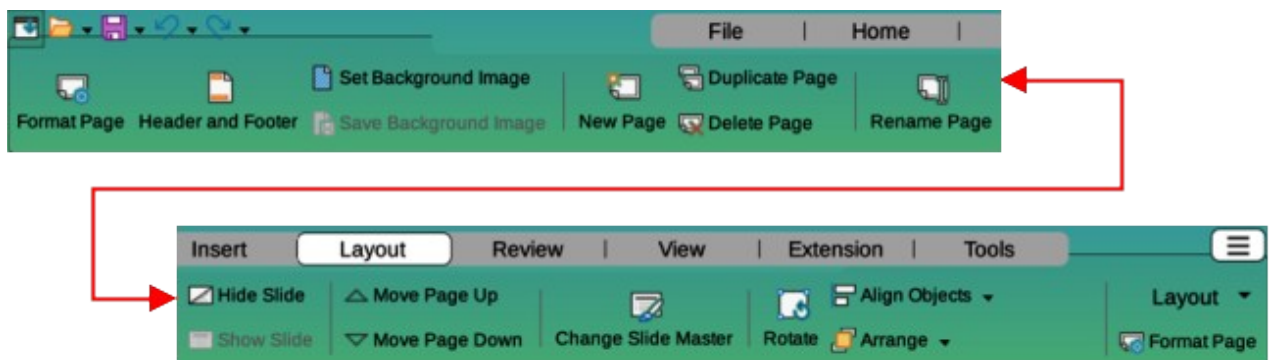

Figure 321: Tabbed User Interface — Layout tab

Review tab

The **Review** tab (Figure 322) provides tools and commands for spell checking text; inserting and deleting review comments; and redaction. The **Review** menu at the right end of the **Review** tab provides additional text editing commands. Some of these commands appear only if **Asian** or **Complex Text Layout** are selected in **Tools > Options > Language Settings > Languages** (macOS LibreOffice > Preferences > Language Settings > Languages).

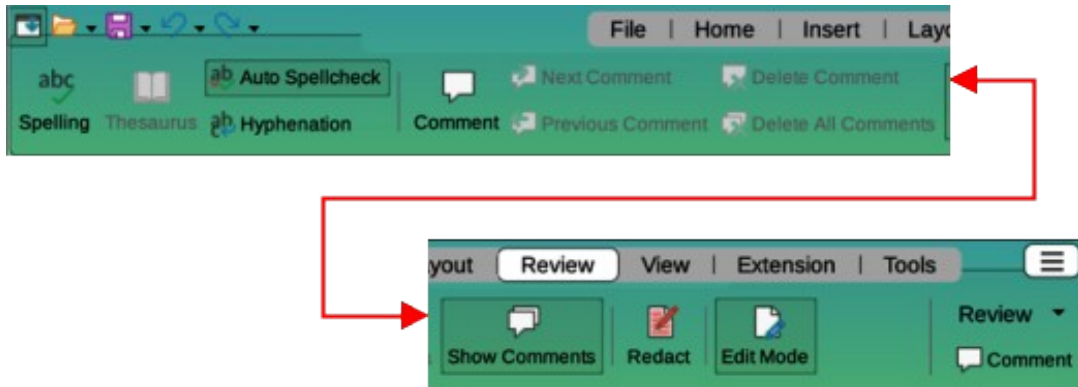

Figure 322: Tabbed User Interface — Review tab

View tab

The **View** tab (Figure 323) provides tools and commands for displaying a drawing on screen. The **View** menu at the right end of the **View** tab provides additional tools for displaying a drawing on screen.

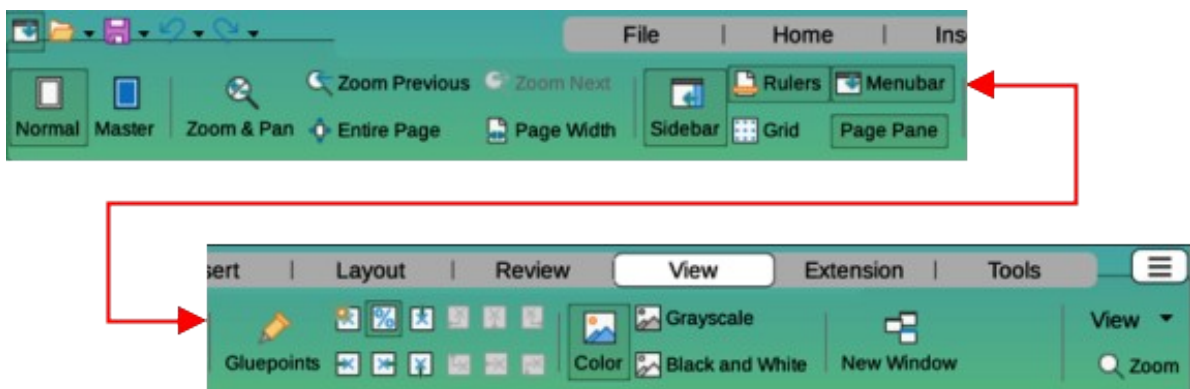

Figure 323: Tabbed User Interface — View tab

Extension tab

The **Extension** tab (Figure 324) only has the tool for the Extension Manager. This allows installation of extensions that are compatible for use in LibreOffice.



Figure 324: Tabbed User Interface — Extension tab

Tools tab

The **Tools** tab (Figure 325) provides several tools and commands for macros, color replacer, and media player. The **Tools** tab menu at the right end of the **Tools** tab provides some of the same tools and commands, plus extra tools for organizing macros and dialogs, image map, data sources, filter settings, extension manager, and options.

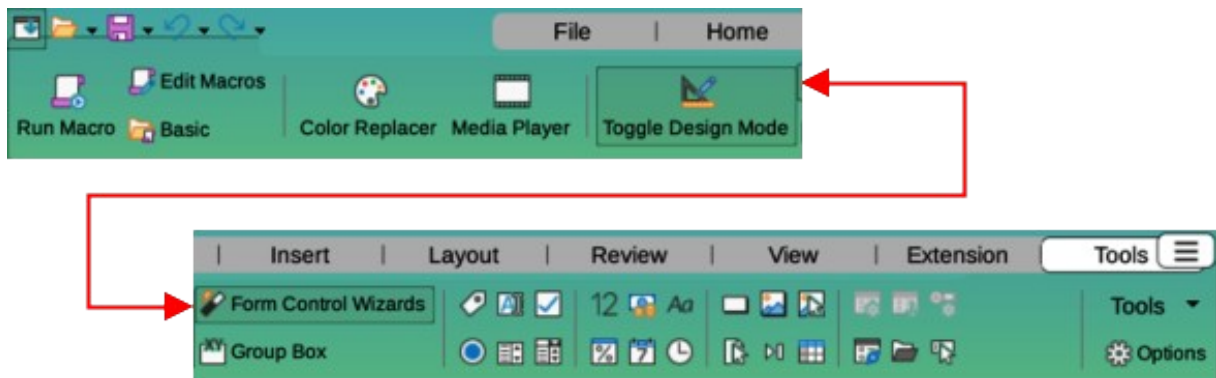

Figure 325: Tabbed User Interface — Tools tab

Additional tabs

Additional tabs appear when an object in Draw is selected and are displayed between the **View** and **Extension** tabs.

Draw tab

The **Draw** tab (Figure 326) is only available when a draw object is selected. It provides tools and commands for editing, transforming, grouping, aligning, and distributing draw objects. The **Draw** tab menu at the right end of the **Draw** tab provides a similar set of tools and commands for editing, transforming and converting draw objects.

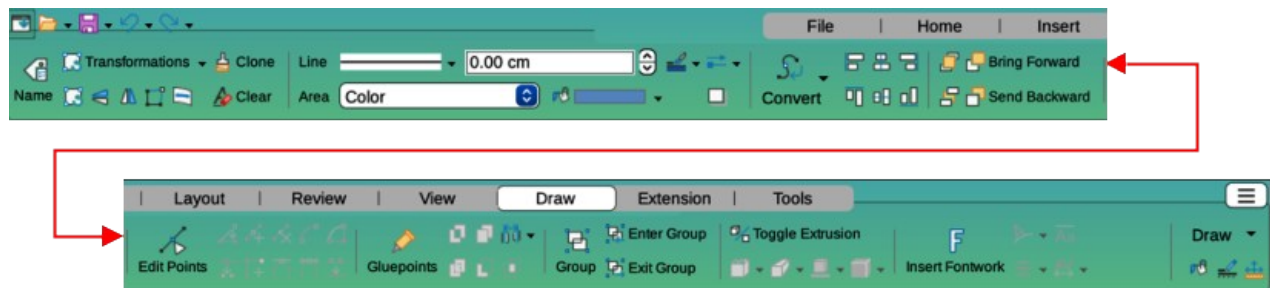

Figure 326: Tabbed User Interface — Draw tab

Image tab

The **Image** tab (Figure 327) is only available when an image is selected such as a photograph, Fontwork, OLE object, or QR code. It provides tools and commands for working with images, including captions, cropping, borders and area styles and colors, anchors, wrapping, positioning, and filtering. The **Image** tab menu at the right end of the **Image** tab provides links to dialogs for working with images.

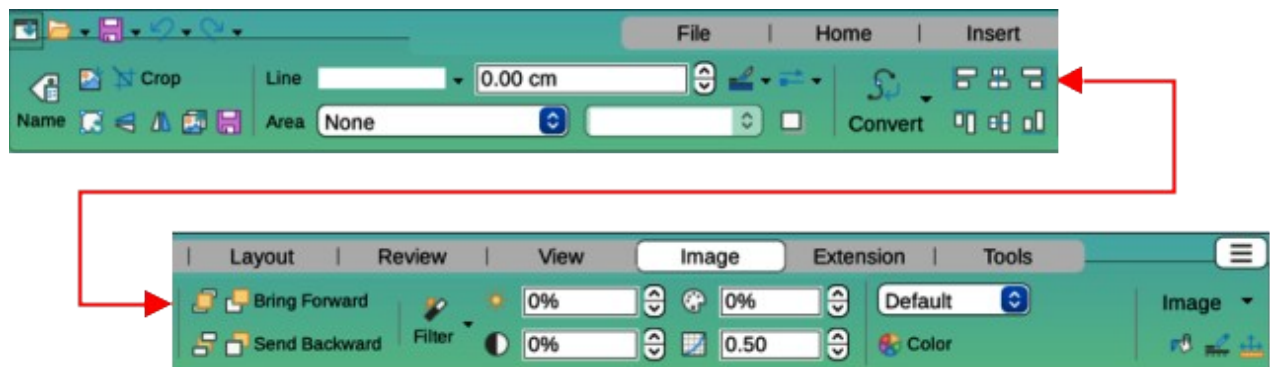

Figure 327: Tabbed User Interface — Image tab

Object tab

The **Object** tab (Figure 328) is only available when an object, such as a chart, is selected. It provides tools and commands to position, resize, choose colors and borders for the selected object. The **Object** tab menu at the right end of the **Object** tab provides extra tools and commands matching the type of object selected.

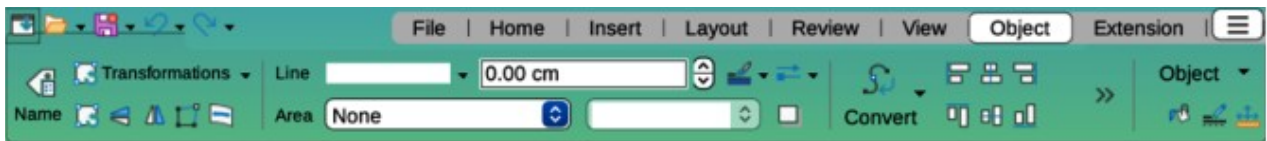

Figure 328: Tabbed User Interface — Object tab

Table tab

The **Table** tab (Figure 329) is only available when a table is selected. It provides tools and commands to format a table to the drawing requirements. The **Table** tab menu at the right end of the **Table** tab provides extra tools for editing a table.

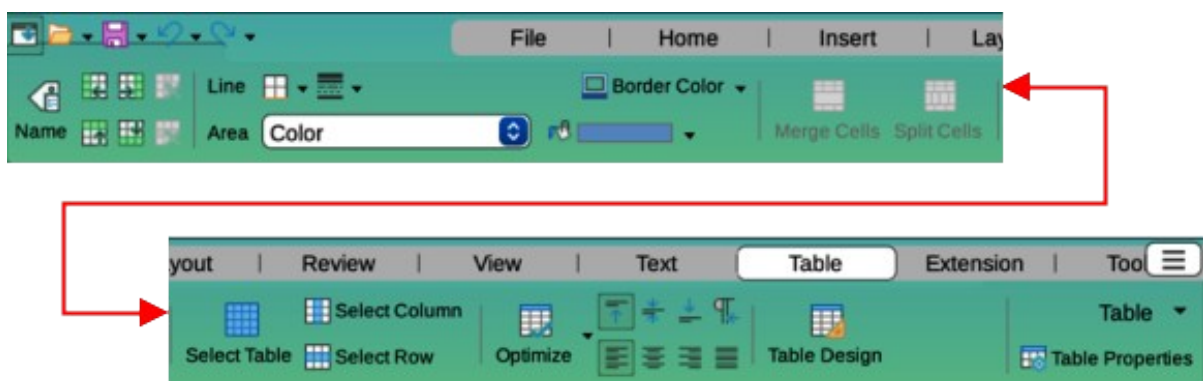

Figure 329: Tabbed User Interface — Table tab

Media tab

The **Media** tab (Figure 330) is only available when a media object is selected. It provides tools and commands for positioning and running an audio or video file. The **Media** tab menu at the right end of the **Media** tab provides extra tools for editing a media object.

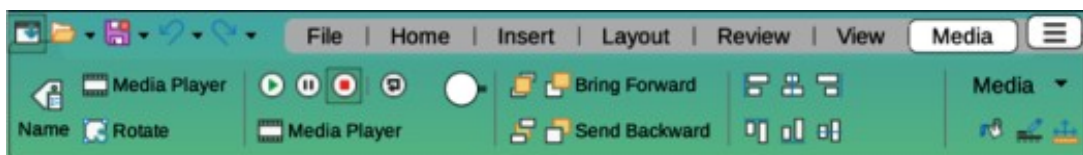

Figure 330: Tabbed User Interface — Media tab

Single Toolbar & Sidebar UI

When selected, the **Single Toolbar** and **Sidebar** user interfaces (Figure 331) only show the Menu bar with no toolbars. However, toolbars can be added to either user interface by going to **View > Toolbars** on the Menu bar and selecting the required toolbar from the options available. For more information on toolbars, see Appendix B, Toolbars in this guide and the *Getting Started Guide*.

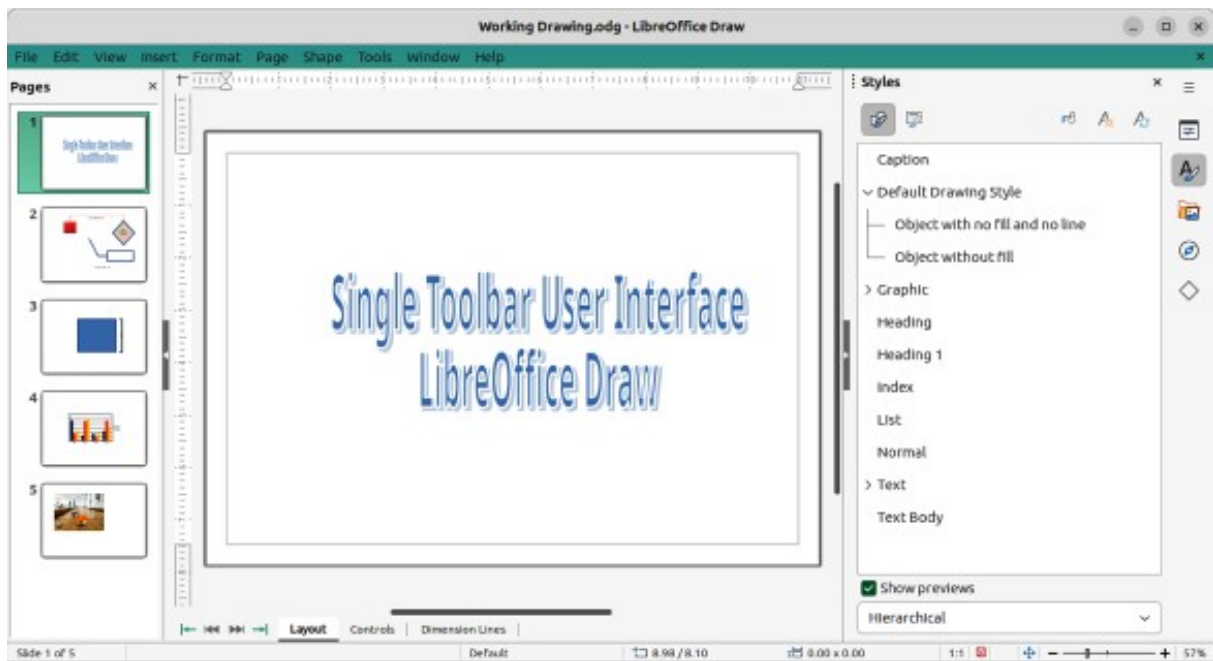

Figure 331: Single Toolbar & Sidebar User Interfaces



Figure 332: Tabbed Compact User Interface

Tabbed Compact UI

The **Tabbed Compact** user interface has the same tabs as the **Tabbed** user interface, but the commands on each tab are arranged as a single row of tools and commands. Some tools have drop-down menus with extra options. Figure 332 shows an example of the **File** tab in the **Tabbed Compact** user interface. When displayed, clicking on the double chevron >> on the right of the tab bar displays more tools and commands for editing an object.

The tab menu on the right of the **Tabbed Compact** user interface provides the same tools and commands as the tab menus in the **Tabbed** user interface, see “Tabbed UI” on page 317 for more information.

Groupedbar Compact UI

The **Groupedbar Compact** user interface provides access to tools and commands in groups using icons for frequently used tools and drop-down menus for other tools and commands. Figure 333 shows an example of a Compact Groupedbar user interface with a text object selected in a Draw document and is organized as sets of tools and menus. The tools and menus that are available change to suit the type of object selected. Clicking on the double chevron >> displays more tools for editing an object.

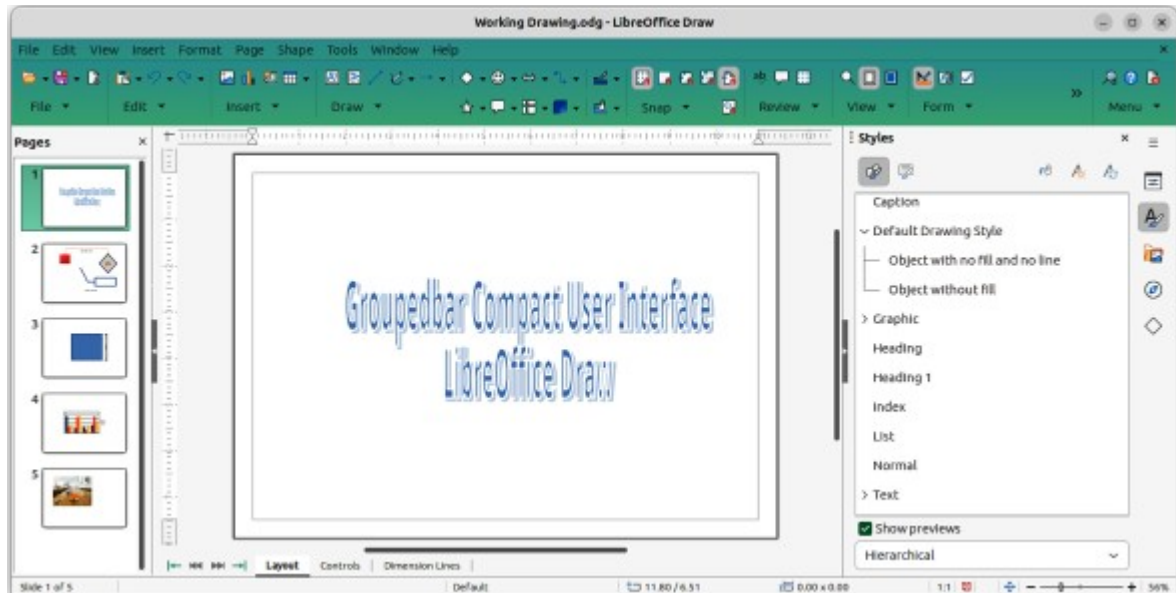

Figure 333: Groupedbar Compact User Interface

Contextual Single UI

The **Contextual Single** user interface displays a single toolbar for the type of selected object. Figure 334 shows an example of **Contextual Single** user interface when a draw object is selected. Clicking on the double chevron >> displays more options for editing an object.

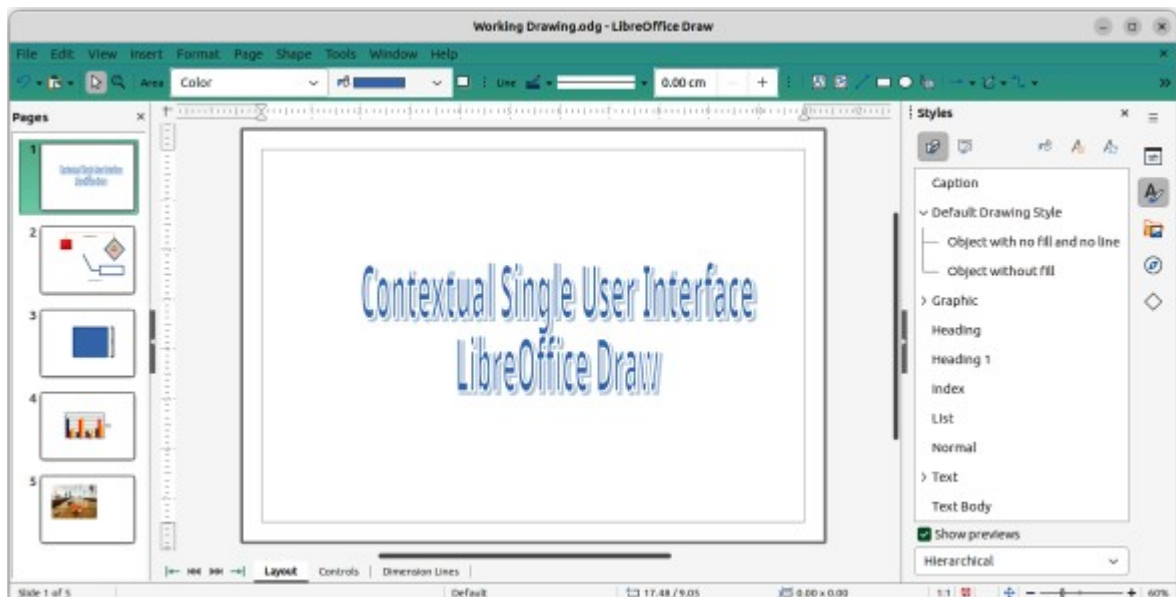

Figure 334: Contextual Single User Interface



LibreOffice
Community



Draw Guide 7.5

Appendix A, Keyboard Shortcuts

Introduction

LibreOffice can be used without requiring a pointing device, such as a mouse or trackball, by using the available keyboard shortcuts in Draw. Tasks as varied and complex as docking and undocking toolbars and windows, or changing the size or position of objects are accomplished using keyboard shortcuts. Although LibreOffice has an extensive set of keyboard shortcuts, each LibreOffice module has keyboard shortcuts that are specific to that module.

For help with LibreOffice keyboard shortcuts, or using LibreOffice with a keyboard only, search the LibreOffice Help using the “shortcut” or “accessibility” as keywords.

Keyboard shortcuts can also be defined in LibreOffice. For example, assign keyboard shortcuts to standard Draw functions or macros and save them for use with Draw, or with other modules in LibreOffice. To customize keyboard shortcuts, see the *Getting Started Guide* for more information.

macOS keyboard shortcuts

Some keystrokes and menu items are different in macOS from those used in Windows or Linux operating systems. This due to the way the different operating systems work and the different types of keyboards used. Also, labelling on the keyboards may vary depending on the age of a computer and style of keyboard being used. The following information shows the most common variations in macOS for keyboard shortcuts and labelling.

Shift, Control and Alt keys

<i>Windows or Linux</i>	<i>macOS</i>
<i>Control or Ctrl</i>	⌘ or <i>Cmd</i> or <i>Command</i>
<i>Alt</i>	⌥ or <i>Option</i> or <i>Alt</i>
<i>Shift</i> or ⇧	<i>Shift</i> or ⇧
<i>Caps Lock</i>	⇧ or <i>Caps Lock</i>
<i>Control or Ctrl</i>	^ or <i>Control</i> or <i>Ctrl</i>

Home and End keys

<i>Windows or Linux</i>	<i>macOS</i>
<i>Home</i>	<i>Fn+Left Arrow</i>
<i>End</i>	<i>Fn+Right Arrow</i>

Page Up and Page Down

<i>Windows or Linux</i>	<i>macOS</i>
<i>Screen Up</i>	<i>Fn+Up Arrow</i>
<i>Page Up</i>	⌥ or <i>Option</i> or <i>Alt+Fn+Up Arrow</i>
<i>Screen Down</i>	<i>Fn+Down Arrow</i>
<i>Page Down</i>	⌥ or <i>Option</i> or <i>Alt+Fn+Down Arrow</i>

✓ Note

Some keyboard shortcuts are not available for macOS computers and are indicated in the following tables by a blank cell.

Draw function key and keyboard shortcuts

Draw function keys

Windows Linux	macOS	Effect
<i>F1</i>	<i>F1</i>	Opens LibreOffice Draw help.
<i>F2</i>	<i>F2</i>	Switches to text edit mode and opens the Text Formatting toolbar.
<i>F3</i>	<i>F3</i>	Enters a group of objects for editing.
<i>Shift+F3</i>	<i>Shift+F3</i>	Opens the Duplicate dialog of a selected object.
<i>Ctrl+F3</i>	⌘+ <i>F3</i>	Exits a group of objects.
<i>F4</i>	<i>F4</i>	Opens the Position and Size dialog of a selected object.
<i>F5</i>	<i>F5</i>	Opens the Navigator.
<i>F6</i>	<i>F6</i>	Forward navigation of the emphasis within the on screen elements.
<i>Shift+F6</i>	<i>Shift+F6</i>	Backward navigation of the emphasis within the on screen elements.
<i>F7</i>	<i>F7</i>	Starts the spelling checker. Only available in text editing mode.
<i>Shift+F7</i>	<i>Shift+F7</i>	Switches on or off the automatic spell checking. Only available in text editing mode.
<i>Ctrl+F7</i>	⌘+ <i>F7</i>	Opens the Thesaurus dialog for the language being used. Only available in text editing mode.
<i>F8</i>	<i>F8</i>	Opens the Edit Points toolbar.
<i>Ctrl+Shift+F8</i>	⌘+ <i>Shift+F8</i>	Fits text to frame of a selected object.
<i>Shift+F10</i>	<i>Shift+F10</i>	Opens the context menu of a selected object.
<i>F11</i>	⌘+ <i>T</i>	Opens the Styles deck on the Sidebar.

Draw keyboard shortcuts

Windows Linux	macOS	Effect
<i>Plus (+)</i>	<i>Fn+Shift++</i>	Zooms in.
<i>Minus (-)</i>	<i>Fn+--</i>	Zooms out.
<i>Times (×)</i> on number pad	<i>Times (*)</i> on numeric keyboard	Fits the drawing to fill the Workspace view.
<i>Divide (÷)</i> on number pad	<i>Divide (/)</i> on numeric keyboard	Zooms in on the selected object.

<i>Ctrl+Shift+G</i>	<i>⌘+Shift+G</i>	Groups selected objects.
<i>Shift+Ctrl+Alt+G</i>	<i>⌘+Shift+⌘+G</i>	Ungroups selected group.
<i>Ctrl+click</i>	<i>⌘+click</i>	Enters a group to edit individual objects in the group. Click outside the group to return to normal view.
<i>Ctrl+Shift+K</i>	<i>⌘+Shift+K</i>	Combines selected objects.
<i>Ctrl+Shift+Alt+K</i>	<i>⌘+Shift+⌘+K</i>	Splits a selected object that has been combined from a group of two or more objects.
<i>Ctrl++</i>	<i>⌘++</i>	Brings current selection forward.
<i>Ctrl+Shift++</i>	<i>⌘+Shift++</i>	Brings current selection to the front.
<i>Ctrl+-</i>	<i>⌘+-</i>	Sends current selection backward.
<i>Ctrl+Shift+-</i>	<i>⌘+Shift+-</i>	Sends current selection to the back.
<i>Page Up</i>	<i>⌘+Fn+Up Arrow</i>	Switches to previous page. No function on the first page.
<i>Page Down</i>	<i>⌘+Fn+Down Arrow</i>	Switches to next page. No function on the last page.
<i>Ctrl+Page Up</i>	<i>⌘+Fn+Up Arrow</i>	Switches to previous layer.
<i>Ctrl+Page Down</i>	<i>⌘+Fn+Down Arrow</i>	Switches to next layer.
<i>Arrow</i>	<i>Arrow</i>	Moves a selected object in the direction of the arrow.
<i>Ctrl+Arrow</i>	<i>Ctrl+Arrow</i>	Moves the page view in the direction of the arrow.
<i>Left Arrow</i>	<i>Left Arrow</i>	With Pages Pane selected, switches to the previous page in a drawing. No function on the first page.
<i>Right Arrow</i>	<i>Right Arrow</i>	With Pages Pane selected, switches to the next page in a drawing. No function on the last page.
<i>Shift</i>	<i>Shift</i>	When selecting objects, adds or removes object to or from a selection of objects.
<i>Shift</i>	<i>Shift</i>	Hold down <i>Shift</i> then click and drag a selection handle when resizing an object to maintain the proportions of the object.
<i>Shift</i>	<i>Shift</i>	Hold down the <i>Shift</i> key while moving a selected object to constrain the movement in multiples of 45 degrees.
<i>Shift</i>	<i>Shift</i>	Hold down the <i>Shift</i> key before selecting several adjacent objects or characters. Click at the start of a selection, move to the end of the selection.
<i>Ctrl</i>	<i>⌘</i>	Hold down the <i>Ctrl</i> (<i>⌘</i>) key, then click and drag a selected object to create a copy of the object.
<i>Alt</i>	<i>⌘</i>	Hold down the <i>Alt</i> (<i>⌘</i>) key and draw or resize an object from the centre of the object.
<i>Alt</i>	<i>⌘</i>	Hold down the <i>Alt</i> (<i>⌘</i>) key when selecting an object that is behind the currently selected object.
<i>Alt+ Shift</i>	<i>⌘+Shift</i>	Hold down the <i>Alt</i> (<i>⌘</i>)+ <i>Shift</i> keys when selecting an object that is in front of the currently selected object.

<i>Tab</i>	<i>Tab</i>	Selects objects in the order in which they were created.
<i>Shift+Tab</i>	<i>Shift+Tab</i>	Selects objects in the reverse order in which they were created.
<i>Esc</i>	<i>Esc</i>	Exits current mode.
<i>Enter</i>	<i>Enter</i>	Enters text mode if a text object in the drawing is selected.
<i>Ctrl+Enter</i>	<i>⌘+Enter</i>	Inserts a new page after the selected page in a drawing.
<i>Home</i>	<i>Fn+Left Arrow</i>	Selects the first page in a drawing.
<i>End</i>	<i>Fn+Right Arrow</i>	Selects the last page in a drawing.

Editing text keyboard shortcuts

Windows Linux	macOS	Effect
<i>Ctrl+-</i>	<i>⌘+-</i>	Inserts a custom hyphen (soft hyphen) in text at the cursor position.
<i>Ctrl+Shift+-</i>	<i>⌘+Shift+-</i>	Inserts a non-breaking hyphen (hard hyphen) in text at the cursor position.
<i>Ctrl+Shift+Space</i>	<i>⌘+Shift+Space</i>	Inserts a non-breaking space, which is not used for hyphenation and is not expanded if the text is justified.
<i>Shift+Enter</i>	<i>Shift+Enter</i>	Inserts a line break without paragraph change.
<i>Left arrow</i>	<i>Left arrow</i>	Moves the cursor one character to the left.
<i>Shift+Left arrow</i>	<i>Shift+Left arrow</i>	Moves the cursor one character to the left and selects the character.
<i>Ctrl+Left arrow</i>	<i>⌘+Left arrow</i>	Moves the cursor to the beginning of the previous word.
<i>Ctrl+Shift+Left arrow</i>	<i>⌘+Shift+Left arrow</i>	Moves the cursor to the left and selects the word on the left.
<i>Right arrow</i>	<i>Right arrow</i>	Moves the cursor one character to the right.
<i>Shift+Right arrow</i>	<i>Shift+Right arrow</i>	Moves the cursor one character to the right and selects the character.
<i>Ctrl+Right arrow</i>	<i>⌘+Right arrow</i>	Moves the cursor to the beginning of the next word.
<i>Ctrl+Shift+Right arrow</i>	<i>⌘+Shift+Right arrow</i>	Moves the cursor to the right and selects the word on the right.
<i>Up arrow</i>	<i>Up arrow</i>	Moves the cursor up one line.
<i>Shift+Up arrow</i>	<i>Shift+Up arrow</i>	Moves the cursor up one line in the text and selects the lines of text.
<i>Ctrl+Up arrow</i>	<i>⌘+Up arrow</i>	Moves the cursor to the beginning of the paragraph.
<i>Ctrl+Shift+Up arrow</i>	<i>⌘+Shift+Up arrow</i>	Moves the cursor to the beginning of the paragraph. Selects the text in the paragraph from the cursor position to the beginning of the paragraph.
<i>Down arrow</i>	<i>Down arrow</i>	Moves the cursor down one line.

<i>Shift+Down arrow</i>	<i>⌘+Down arrow</i>	Moves the cursor down one line in the text and selects the lines of text.
<i>Ctrl+Down arrow</i>	<i>⌘+Down arrow</i>	Moves the cursor to the end of the paragraph.
<i>Ctrl+Shift+Down arrow</i>	<i>⌘+Shift+Down arrow</i>	Moves the cursor to the end of the paragraph. Selects the text in the paragraph from the cursor position to the end of the paragraph.
<i>Ctrl+Backspace</i>	<i>⌘+Backspace</i>	Deletes the text from the cursor position to the beginning of the word.
<i>Ctrl+Shift+Backspace</i>	<i>⌘+Shift+Backspace</i>	Deletes the text from the cursor position to the beginning of the sentence.

Menu function key and keyboard shortcuts

Function key and keyboard shortcuts listed in the following tables are available in each menu category on the Menu bar. The tables give menu item or sub-item, operating system validity, and effect or purpose of the shortcut.

Note

The menus listed below are in the same order as displayed on the Menu bar from left to right.

LibreOffice

The LibreOffice menu is only available for macOS computers.

Menu item or sub-item	macOS	Effect
Preferences	⌘+,	Opens the Options dialog.
Hide LibreOffice	⌘+H	Temporarily hides LibreOffice, but does not close LibreOffice.
Exit LibreOffice	⌘+Q	Closes LibreOffice. Make sure all LibreOffice files are saved before using.

File menu

Menu item or sub-item	Windows Linux	macOS	Effect
New	<i>Ctrl+N</i>	⌘+N	Opens a new drawing.
Templates	<i>Shift+Ctrl+N</i>	⌘+Shift+N	Opens the Drawings category in the Templates dialog.
Open	<i>Ctrl+O</i>	⌘+O	Opens a file browser allowing navigation to a folder and file selection.
Manage Templates	<i>Shift+Ctrl+N</i>	⌘+Shift+N	Opens the Drawings category in the Templates dialog.
Save	<i>Ctrl+S</i>	⌘+S	Saves the open drawing.
Save As	<i>Ctrl+Shift+S</i>	⌘+Shift+S	Opens a file browser allowing navigation to a folder and save the open drawing as a new file.

Print	<i>Ctrl+P</i>	⌘+P	Opens the Print dialog allowing selection of how the drawing is printed.
Exit LibreOffice	<i>Ctrl+Q</i>	⌘+Q	Closes LibreOffice. Make sure all files are saved before using.

Edit Menu

Menu item or sub-item	Windows Linux	macOS	Effect
Undo	<i>Ctrl+Z</i>	⌘+Z	Undoes the previous editing action.
Redo	<i>Ctrl+Y</i>	⌘+Y	Reverses the action of the last Undo command.
Cut	<i>Ctrl+X</i>	⌘+X	Deletes the selected object and places it on the clipboard.
Copy	<i>Ctrl+C</i>	⌘+C	Copies the selected object to the clipboard.
Paste	<i>Ctrl+V</i>	⌘+V	Inserts the contents of the clipboard at the location of the cursor replacing any selected text or objects.
Paste Special > Paste Special	<i>Ctrl+Shift+V</i>	⌘+Shift+V	Pastes the contents of the clipboard at the cursor position in a format that is specified using the Paste Special dialog.
Duplicate	<i>Shift+F3</i>	<i>Shift+F3</i>	When an object is selected, opens the Duplicate dialog providing options for duplicating a selected object.
Select All	<i>Ctrl+A</i>	⌘+A	Selects all the pages and objects in a drawing.
Find	<i>Ctrl+F</i>	⌘+F	Opens the Find toolbar.
Replace	<i>Ctrl+H</i>	⌘+⌘+F	Opens the Find and Replace dialog.
Points	<i>F8</i>	<i>F8</i>	Opens the Edit Points toolbar if there is an object on the drawing that uses editable points, for example a freeform line.
Edit Mode	<i>Ctrl+Shift+M</i>	⌘+Shift+M	Allows a read only drawing to be edited if the user has writer permission.

View menu

Menu item or sub-item	Windows Linux	macOS	Effect
Rulers	<i>Ctrl+Shift+R</i>	⌘+Shift+R	Switches the rulers off and on in the Workspace.
Sidebar	<i>Ctrl+F5</i>	⌘+F5	Opens or closes the Sidebar.
Styles	<i>F11</i>	⌘+T	Opens or closes the Styles deck on the Sidebar.
Navigator	<i>F5</i>	<i>F5</i>	Opens the Navigator dialog.

Insert menu

Menu item or sub-item	Windows Linux	macOS	Effect
Text Box	<i>F2</i>	<i>F2</i>	Switches to text edit mode and opens the Text Formatting toolbar.
Comment	<i>Ctrl+Alt+C</i>	<i>⌘+⌘+C</i>	Inserts a new comment box onto the selected page.
Hyperlink	<i>Ctrl+K</i>	<i>⌘+K</i>	Opens the Hyperlink dialog.
Insert non-breaking space	<i>Ctrl+Shift+Space</i>	<i>⌘+Shift+Space</i>	Inserts a non-breaking space at the cursor position.
Insert Narrow No-break Space	<i>Alt+Shift+Space</i>	<i>⌘+Shift+Space</i>	Inserts a narrow non-breaking space at the cursor position.
No-width Optional Break	<i>Ctrl+/</i>	<i>⌘+ /</i>	Inserts a narrow no-width optional break at the cursor position.

Format menu

Menu item or sub-item	Windows Linux	macOS	Effect
Bold	<i>Ctrl+B</i>	<i>⌘+B</i>	Applies Bold format to selected text.
Italic	<i>Ctrl+I</i>	<i>⌘+I</i>	Applies <i>Italic</i> format to selected text.
Superscript	<i>Ctrl+Shift+P</i>	<i>⌘+Shift+P</i>	Reduces the font size of the selected text and raises the text above the baseline.
Subscript	<i>Ctrl+Shift+B</i>	<i>⌘+Shift+B</i>	Reduces the font size of the selected text and lowers the text below the baseline.
Increase Size	<i>Ctrl+]]</i>	<i>⌘+]]</i>	Increases the point size of selected text.
Decrease Size	<i>Ctrl+[[</i>	<i>⌘+[[</i>	Decreases the point size of selected text.
Line Spacing 1	<i>Ctrl+1</i>	<i>⌘+1</i>	Sets the line spacing in a paragraph to a single line.
Line Spacing 5	<i>Ctrl+5</i>	<i>⌘+5</i>	Sets the line spacing in a paragraph to one and half lines.
Line Spacing 2	<i>Ctrl+2</i>	<i>⌘+2</i>	Sets the line spacing in a paragraph to two lines.
Left	<i>Ctrl+L</i>	<i>⌘+L</i>	Sets the paragraph alignment to left aligned.
Center	<i>Ctrl+E</i>	<i>⌘+E</i>	Sets the paragraph alignment to center aligned.
Right	<i>Ctrl+R</i>	<i>⌘+R</i>	Sets the paragraph alignment to right aligned.
Justified	<i>Ctrl+J</i>	<i>⌘+J</i>	Sets the paragraph alignment to justified.
Clear Direct Formatting	<i>Ctrl+M</i>	<i>⌘+M</i>	Removes direct formatting that has been applied without using styles.
Edit Style	<i>Alt+P</i>	<i>⌘+P</i>	Opens the Graphic Styles dialog to edit a selected style.

Manage Styles	<i>F11</i>	⌘+T	Opens or closes the Styles deck on the Sidebar.
Position and Size	<i>F4</i>	<i>F4</i>	Opens the Position and Size dialog of a selected object.

Shape menu

Menu item or sub-item	Windows Linux	macOS	Effect
Bring to Front	<i>Ctrl+Shift++</i>	⌘+Shift++	Moves a selected object to the front of other objects.
Bring Forward	<i>Ctrl++</i>	⌘++	Moves a selected object in front of the forward object.
Send Backward	<i>Ctrl+-</i>	⌘+-	Moves a selected object behind the backward object.
Send to Back	<i>Ctrl+Shift+-</i>	⌘+Shift+-	Moves a selected object to the back of other objects.
Group	<i>Ctrl+Shift+G</i>	⌘+Shift+G	Groups selected objects.
Ungroup	<i>Ctrl+Alt+Shift+G</i>	⌘+⌘+Shift+G	Ungroups selected group.
Enter Group	<i>F3</i>	<i>F3</i>	Enters a group of objects for editing.
Exit Group	<i>Ctrl+F3</i>	⌘+F3	Exits a group of objects.
Combine	<i>Ctrl+Shift+K</i>	⌘+Shift+K	Combines two or more selected objects into a single shape.
Split	<i>Ctrl+Shift+Alt+K</i>	⌘+⌘+Shift+K	Splits a combined object into individual objects.
Duplicate	<i>Shift+F3</i>	<i>Shift+F3</i>	When an object is selected, opens the Duplicate dialog providing options for duplicating a selected object.

Tools menu

Menu item or sub-item	Windows Linux	macOS	Effect
Spelling	<i>F7</i>		Starts spelling checker. Only available in text editing mode.
Automatic Spell Checking	<i>Shift+F7</i>	<i>Shift+F7</i>	Switches on or off the automatic spell checking. Only available in text editing mode.
Thesaurus	<i>Ctrl+F7</i>	⌘+F7	Opens the thesaurus dialog for the language being used. Only available in text editing mode.
Extension Manager	<i>Ctrl+Alt+E</i>	⌘+⌘+E	Opens the Extension Manager dialog.
Options	<i>Alt+F12</i>		Opens the Options LibreOffice dialog.

Windows menu

Menu item or sub-item	Windows Linux	macOS	Effect
Closes Window	<i>Ctrl+W</i>	⌘+W	Closes the active window. If there is only one window, closes LibreOffice.

Help menu

Menu item or sub-item	Windows Linux	macOS	Effect
LibreOffice Help	<i>F1</i>	<i>F1</i>	Opens a browser application at the LibreOffice Help pages.
Search Commands	<i>Shift+Esc</i>		Opens a dialog to search for a command.

General function key and keyboard shortcuts

Opening menus and menu items

Windows Linux	macOS	Effect
<i>Alt+<?></i> (Windows only) <i>F6+<?></i> (Linux only)		Press the <i>Alt</i> key first, then select the underlined character of the menu to be opened. The <i><?></i> is the underlined character in the menu. For example, <i>Alt+F</i> opens the File menu. With the menu open, menu items have an underlined character. To access these menu items directly, press the underlined character key. Where two menu items have the same underlined character, press the character key again to move to the next item. If an item in a menu has no underlined character, click on the menu item directly.
<i>Esc</i>	<i>Esc</i>	Closes an open menu.
<i>F6</i>	<i>F6</i>	Repeatedly pressing <i>F6</i> cycles the focus through the following objects: Menu bar (Windows and Linux operating systems only) Each toolbar from top to bottom and from left to right Each free window from left to right Drawing
<i>Shift+F6</i>	<i>Shift+F6</i>	Repeatedly pressing <i>Shift+F6</i> cycles the focus in the opposite direction.
<i>Ctrl+F6</i>	⌘+F6	Cycles the focus back to the drawing.
<i>F10</i>		Switches the access on or off for the Menu bar.

Accessing Menu bar commands

- Press *F6* selects the first item on the Menu bar (the File menu).
- Press the right arrow selects the next menu to the right.

- Press the left arrow selects the previous menu to the left.
- Press the *Home* and *End* keys selects the first or last item on the Menu bar.
- Press the down arrow to open a selected menu. An additional press on the down arrow or up arrow moves the selection through the menu commands.
- Press the right arrow to open any submenus on the selected menu. Submenus are indicated by a triangle ► or chevron > next to the menu item.
- Press *Enter* to execute the selected menu command.

Accessing toolbar commands

- Press F6 repeatedly until the first tool on a toolbar is selected.
- Using the right and left arrows selects a tool on a horizontal toolbar, or the up and down arrows selects a tool on a vertical toolbar.
- Pressing the *Home* key selects the first tool on a toolbar, or the *End* key selects the last tool on a toolbar.
- Pressing *Enter* activates the selected tool.
- Pressing the right arrow opens any sub-toolbar on a selected toolbar. Sub-toolbars are indicated by a triangle ▼ next to the tool.
- Pressing *Ctrl+Enter* inserts a selected draw object. The draw object is placed in the center of the drawing, with a predefined size.

Controlling dialogs

When any dialog is open, one element (for example a button or option field) indicates focus by highlighting, a check mark, or a dotted box around the field or button name.

<i>Windows Linux</i>	<i>Effect</i>
<i>Enter</i>	Activates the selected option. Where no option is selected, <i>Enter</i> is the equivalent to clicking on OK .
<i>Esc</i>	Closes a dialog without saving any changes made while it was open, the equivalent to selecting Cancel .
<i>Up/Down arrow keys</i>	Moves focus up and down a list. Increases or decreases the value of a variable. Moves focus vertically within a section of dialog.
<i>Left/Right arrow keys</i>	Moves focus horizontally within a section of a dialog.
<i>Tab</i>	Advances focus to the next section or element of a dialog.
<i>Shift+Tab</i>	Moves the focus to the previous section or element in a dialog.
<i>Alt+Down Arrow</i>	Shows the options available in a drop-down list.
<i>Spacebar</i>	Checks or selects an empty checkbox. Clears or deselects a checked checkbox.

Toolbar function key and keyboard shortcuts

Draw provides several toolbars for the creation and editing of drawings. Some tools on the Draw toolbars can be activated using a function key, or keyboard shortcut.

✓ Note

The Draw toolbars are listed in the same order displayed in the context menu that opens when **View > Toolbars** is selected on the Menu bar.

Drawing

<i>Tool name</i>	<i>Windows Linux</i>	<i>macOS</i>	<i>Effect</i>
Insert Text Box	<i>F2</i>	<i>F2</i>	Switches to text edit mode and opens the Text Formatting toolbar.
Edit Points	<i>F8</i>	<i>F8</i>	Opens the Edit Points toolbar if there is an object on the drawing that uses editable points, for example a freeform line.

Find

<i>Tool name</i>	<i>Windows Linux</i>	<i>macOS</i>	<i>Effect</i>
Find and Replace	<i>Ctrl+H</i>	<i>⌘+⌘+H</i>	Finds and replaces all instances of text in a drawing.

Form Design

<i>Tool name</i>	<i>Windows Linux</i>	<i>macOS</i>	<i>Effect</i>
Bring to Front	<i>Ctrl+Shift++</i>	<i>⌘+Shift++</i>	Moves a selected object to the front of other objects.
Send to Back	<i>Ctrl+Shift+-</i>	<i>⌘+Shift+-</i>	Moves a selected object to the back of other objects.
Group	<i>Ctrl+Shift+G</i>	<i>⌘+Shift+G</i>	Groups selected objects.
Ungroup	<i>Ctrl+Alt+Shift+G</i>	<i>⌘+⌘+Shift+G</i>	Ungroups selected group.
Enter Group	<i>F3</i>	<i>F3</i>	Enters a group of objects for editing.
Exit Group	<i>Ctrl+F3</i>	<i>⌘+F3</i>	Exits a group of objects.

Image

<i>Tool name</i>	<i>Windows Linux</i>	<i>macOS</i>	<i>Effect</i>
Position and Size	<i>F4</i>	<i>F4</i>	Opens the Position and Size dialog of a selected object.
Bring to Front	<i>Ctrl+Shift++</i>	<i>⌘+Shift++</i>	Moves a selected object to the front of other objects.
Bring Forward	<i>Ctrl++</i>	<i>⌘++</i>	Moves a selected object in front of the forward object.
Send Backward	<i>Ctrl+-</i>	<i>⌘+-</i>	Moves a selected object behind the backward object.

Send to Back	<i>Ctrl+Shift+-</i>	<i>⌘+Shift+-</i>	Moves a selected object to the back of other objects.
--------------	---------------------	------------------	---

Line and Filling

Tool name	Windows Linux	macOS	Effect
Position and Size	<i>F4</i>	<i>F4</i>	Opens the Position and Size dialog of a selected object.
Bring to Front	<i>Ctrl+Shift++</i>	<i>⌘+Shift++</i>	Moves a selected object to the front of other objects.
Bring Forward	<i>Ctrl++</i>	<i>⌘++</i>	Moves a selected object in front of the forward object.
Send Backward	<i>Ctrl+-</i>	<i>⌘+-</i>	Moves a selected object behind the backward object.
Send to Back	<i>Ctrl+Shift+-</i>	<i>⌘+Shift+-</i>	Moves a selected object to the back of other objects.
Styles	<i>F11</i>	<i>⌘+T</i>	Opens the Styles deck on the Sidebar.

Standard

Tool name	Windows Linux	macOS	Effect
New	<i>Ctrl+N</i>	<i>⌘+N</i>	Opens a new drawing.
Templates	<i>Ctrl+Shift+N</i>	<i>⌘+Shift+N</i>	Opens the Templates dialog to create a new drawing using a template.
Open	<i>Ctrl+O</i>	<i>⌘+O</i>	Opens the Open file browser to allow navigation to a folder and selection of a drawing.
Save	<i>Ctrl+S</i>	<i>⌘+S</i>	Saves the open document.
Save As	<i>Ctrl+Shift+S</i>	<i>⌘+Shift+S</i>	Opens the Save as file browser to save the open drawing as a new drawing.
Edit Mode	<i>Ctrl+Shift+M</i>	<i>⌘+Shift+M</i>	Switches on edit mode when a drawing is in read only mode.
Print	<i>Ctrl+P</i>	<i>⌘+P</i>	Opens the Print dialog to select how to print the drawing.
Cut	<i>Ctrl+X</i>	<i>⌘+X</i>	Deletes the selected object and places it on the clipboard.
Copy	<i>Ctrl+C</i>	<i>⌘+C</i>	Copies the selected object to the clipboard.
Paste	<i>Ctrl+V</i>	<i>⌘+V</i>	Places the object on the clipboard into the document.
Clear	<i>Ctrl+M</i>	<i>^+M</i>	Removes direct formatting that has been applied without using styles.
Undo	<i>Ctrl+Z</i>	<i>⌘+Z</i>	Undoes the previous editing action.
Redo	<i>Ctrl+Y</i>	<i>⌘+Y</i>	Reverses the action of the last Undo command.

Spelling	<i>F7</i>	<i>F7</i>	Starts the spelling checker. Only available in text editing mode.
Auto Spellcheck	<i>Shift+F7</i>	<i>Shift+F7</i>	Switches on or off the automatic spell checking. Only available in text editing mode.
Text Box	<i>F2</i>		Switches to text edit mode and opens the Text Formatting toolbar.
Insert Hyperlink	<i>Ctrl+K</i>		Opens the Hyperlink dialog.
Position and Size	<i>F4</i>		Opens the Position and Size dialog of a selected object.
Edit Points	<i>F8</i>		Opens the Edit Points toolbar if there is an object on the drawing that uses editable points, for example a freeform line.

Standard (Viewing Mode)

<i>Tool name</i>	<i>Windows Linux</i>	<i>macOS</i>	<i>Effect</i>
Save As	<i>Ctrl+Shift+S</i>	<i>⌘+Shift+S</i>	Opens the Save as file browser so you can save the open document as a new document.
Edit Mode	<i>Ctrl+Shift+M</i>	<i>⌘+Shift+M</i>	Switches on edit mode when a document is in read only mode.
Print	<i>Ctrl+P</i>	<i>⌘+P</i>	Opens the Print dialog so that you can select how you want to print the document.
Copy	<i>Ctrl+C</i>	<i>⌘+C</i>	Copies the selected object to the clipboard.
Find and Replace	<i>Ctrl+H</i>	<i>⌘+⌘+F</i>	Opens the Find and Replace dialog.

Text Formatting

<i>Tool name</i>	<i>Windows Linux</i>	<i>macOS</i>	<i>Effect</i>
Increase	<i>Ctrl+]]</i>	<i>⌘+]]</i>	Increases the point size of selected text.
Decrease	<i>Ctrl+[[</i>	<i>⌘+[[</i>	Decreases the point size of selected text.
Bold	<i>Ctrl+B</i>	<i>⌘+B</i>	Applies Bold format to selected text.
Italic	<i>Ctrl+I</i>	<i>⌘+I</i>	Applies <i>Italic</i> format to selected text.
Superscript	<i>Ctrl+Shift+P</i>	<i>⌘+Shift+P</i>	Reduces the font size of the selected text and raises the text above the baseline.
Subscript	<i>Ctrl+Shift+B</i>	<i>⌘+Shift+B</i>	Reduces the font size of the selected text and lowers the text below the baseline.
Clear	<i>Ctrl+M</i>	<i>⌘+M</i>	Removes direct formatting that has been applied without using styles.
Left	<i>Ctrl+L</i>	<i>⌘+L</i>	Sets the paragraph alignment to left aligned.

Center	<i>Ctrl+E</i>	⌘+E	Sets the paragraph alignment to center aligned.
Right	<i>Ctrl+R</i>	⌘+R	Sets the paragraph alignment to right aligned.
Justified	<i>Ctrl+J</i>	⌘+J	Sets the paragraph alignment to justified.
Select All	<i>Ctrl+A</i>	⌘+A	Selects all the text in a text box.



LibreOffice
Community



Draw Guide 7.5

Appendix B, Toolbars

Introduction

Draw provides several toolbars for creating drawings. Each toolbar has a default set of tools when LibreOffice is installed on a computer. To improve the usability of a toolbar, additional tools can be added, see “Editing toolbars” on page 347 for more information.

Note

The toolbar icons displayed in this user guide may differ from what is displayed on a computer screen. Toolbar icons depend on the computer operating system being used and how LibreOffice has been set up. For more information on customizing LibreOffice and the toolbars, see the *Getting Started Guide*.

Using toolbars

To display and make a toolbar active, go to **View > Toolbars** on the Menu bar. A submenu opens with an alphabetical list of toolbars available for creating drawings. Click on a toolbar name to display it and make it active. Active toolbars are indicated by highlighting or a check mark next to the toolbar name.

Draw toolbars available

3D-Objects	Form Design	Options
3D-Settings	Form Navigation	Redaction
Align Objects	Gluepoints	Standard
Comments	Image	Standard (Viewing Mode)
Distribute Selection	Insert	Table
Drawing	Legacy Circles and Ovals	Text
Edit Points	Legacy Rectangles	Text Formatting
Find	Line and Filling	Transformations
Fontwork	Master View	Zoom
Form Controls	Media Playback	

Note

Some toolbars, although selected in **View > Toolbars** on the Menu bar, do not display until an object of the correct type is selected. For example, the Image toolbar only displays when an image is selected.

Closing toolbars

To close a toolbar, use one of the following methods:

- Go to **View > Toolbars** on the Menu bar and deselect the toolbar.
- Right-click on a tool on a toolbar and select **Close Toolbar** from the context menu.
- Click on the **X** in the right corner of the title bar of a floating toolbar.

Moving toolbars

Docked toolbars

By default, some toolbars are docked into position in the Draw main window. For example, in the Draw main window, the Standard toolbar is docked at the top and the Drawing toolbar on the left side. Docked toolbars can be undocked and moved to a new docked position on the main window or left as a floating toolbar. Before moving a toolbar, the toolbar must be unlocked.

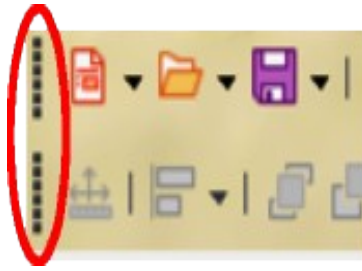

Figure 335: Toolbar handles highlighted

- 1) Move the cursor over the small vertical handle at the left end of the toolbar (highlighted in Figure 335). The cursor changes to a moving cursor for the computer system and setup.
- 2) Click and drag the toolbar to a new location. This can be a new docked position or a floating toolbar. A hashed border appears around the toolbar indicating the toolbar position as it is dragged.
- 3) Release the toolbar when the required position is reached.

 **Note**

If the small vertical bar is not visible at the left end of a docked toolbar, then the toolbar is locked into position. A docked toolbar must be unlocked before it can be moved. See “Locking toolbars” on page 346 for more information.

Floating toolbars

To move a floating toolbar, click on the title bar and drag it to a new floating location. Release the toolbar when it is in the required position. A floating toolbar does not have to be positioned on the Draw main window for it to function.

Floating sub-toolbars

Some tools on a toolbar have a triangle ▼ to the right of the tool indicating that more tools are available on a sub-toolbar, for example **Basic Shapes** on the Drawing toolbar. Sub-toolbars can be turned into floating toolbars and moved into a new position as follows:

- 1) Move the cursor over the horizontal handle at the top of the sub-toolbar (highlighted in Figure 336). The cursor changes to the moving cursor used for the computer system and setup.
- 2) Click and drag the sub-toolbar to a new location creating a floating sub-toolbar.
- 3) Release the sub-toolbar when the required position is reached.
- 4) To close the floating sub-toolbar, right-click on the triangle ▼ in the sub-toolbar title bar and select **Close Toolbar** from the context menu.
- 5) Alternatively, click on the **X** in the right corner of the title bar of a floating sub-toolbar

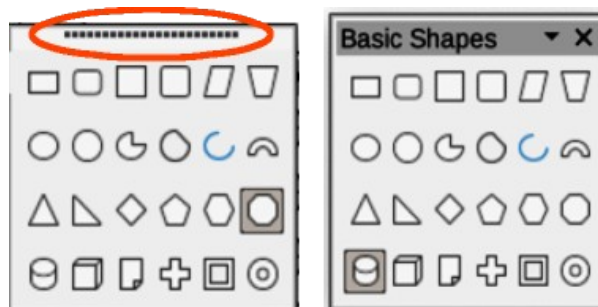

Figure 336: Creating floating sub-toolbar

Docking a floating toolbar

To dock a floating toolbar, use one of the following methods:

- Click on the title bar and drag it to the top, bottom, left side, or right side of the main window. When the toolbar reaches a docking position, a hashed border appears at the docked position. Release the toolbar and it is docked in the required position.
- Right-click on the toolbar and select **Dock Toolbar** from the context menu. The toolbar moves into a docked position. If the position is not suitable, move the toolbar to a new docked position.
- To dock all floating toolbars that are active, right-click on the toolbar and select **Dock All Toolbars** from the context menu.

Locking toolbars

Docked toolbars

When a toolbar has been docked into position, the toolbar is locked into position preventing the toolbar from becoming a floating toolbar.

- To lock a toolbar into a docked position, right-click in a blank area on the toolbar and select **Lock Toolbar Position** in the context menu. The small vertical or horizontal bar at the left end or top of the toolbar disappears indicating that the toolbar is locked.
- To unlock a toolbar, right-click in a blank area on the toolbar and click on **Lock Toolbar Position** in the context menu. A small vertical or horizontal bar appears at the left end or top of the toolbar indicating that the toolbar is unlocked. This bar is also used to move the toolbar.

✓ Notes

The **Lock Toolbar Position** is used for locking and unlocking a toolbar, acting like an on/off switch.

Some toolbars cannot be docked or locked into position. This is indicated by the options **Dock Toolbar** and/or **Lock Toolbar Position** being grayed out making both options unavailable.

Locking toolbars and sub-toolbars

To prevent ALL toolbars and sub-toolbars from becoming floating toolbars, all toolbars and sub-toolbars are locked as follows:

- 1) Save the drawing that is open in Draw.
- 2) Go to **View > Toolbars** on the Menu bar and select **Lock Toolbars** from the context menu.
- 3) Select **Restart Now** in the Restart LibreOffice dialog that opens to activate the **Lock Toolbars** option.
- 4) To unlock all toolbars and sub-toolbars so they can be repositioned, repeat Steps 1 thru 3. The **Lock Toolbars** option is an on/off switch.

✓ Note

Using the **Lock Toolbars** option affects all toolbars and sub-toolbars available in LibreOffice modules.

Editing toolbars

When LibreOffice is installed on a computer, it includes a set of toolbars suitable for each LibreOffice component. Each toolbar has a default set of visible tools. Tools can be added or deleted, and toolbars can be customized.

Adding tools

- 1) Right-click in a blank area on a toolbar, or click on the triangle ▼ on the right of the toolbar title bar.
- 2) Select **Visible Buttons** from the context menu to display a list of available tools.
- 3) Click on the tool required and the tool appears in the toolbar. The list of available tools closes automatically. A check mark next to the tool, or highlighting around the tool, indicates that the tool is already installed on the toolbar.

Note

When adding tools using **Visible Buttons**, the tool is added to the toolbar at the same position as the tool appears in the **Visible Buttons** list. That is, the top tool in **Visible Buttons** list appears at the left end of the toolbar and the bottom tool in the list appears at the right end of the toolbar.

Removing tools

- 1) Right-click in a blank area on a toolbar, or click on the triangle ▼ on the right of the toolbar title bar.
- 2) Select **Visible Buttons** from the context menu to display a list of available tools.
- 3) Click on the tool no longer required to deselect it and the tool is removed from the toolbar. The highlighting or check mark is also removed. The list of available tools closes automatically.

Customizing toolbars

Extra tools and commands that are not available in **Visible Buttons** can be added to a toolbar using customization (**View > Toolbars > Customize** on the Menu bar). Customization also allows the creation of new toolbars if a specific set of tools are required for a specific task. For information on customizing toolbars, see the *Getting Started Guide*.

Toolbars

- The number of tools visible on a toolbar depend on the computer setup and operating system being used to create a drawing.
- The tools displayed on the toolbars in this appendix are examples only. Actual tools displayed depend on computer setup, operating system and user preferences.
- The tools already installed on a toolbar are indicated in **Visible Buttons** either by the tool icon being highlighted or by a check mark. This indication depends on computer setup and computer operating system being used.
- On some toolbars, tool icons may have a triangle ▼ to the right of the icon. Click on this triangle to open a list of options, toolbar, or sub-toolbar.
- Some tools also have the option of using a keyboard shortcut instead of clicking on the tool. For a full list of keyboard shortcuts that are available in Draw, see Appendix A, Keyboard Shortcuts.

3D-Objects

The 3D-Objects toolbar (Figure 337) provides tools for creating 3D objects. Go to **View > Toolbars > 3D-Objects** on the Menu bar. Alternatively, click on the triangle ▼ next to the **3D-Objects** icon displayed on the Drawing toolbar to open a submenu giving access to the available 3D objects.

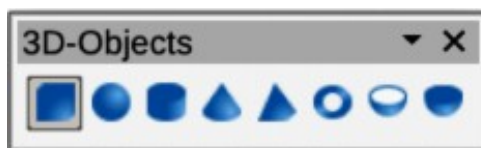

Figure 337: 3D-Objects toolbar

The tools available in **Visible Buttons** for the 3D-Objects toolbar are numbered from left to right when installed on the toolbar.

- | | |
|-------------|----------------|
| 1) Cube | 5) Pyramid |
| 2) Sphere | 6) Torus |
| 3) Cylinder | 7) Shell |
| 4) Cone | 8) Half Sphere |

3D-Settings

The 3D-Settings toolbar (Figure 338) and its tools only become active when an object has been converted to 3D using **Toggle Extrusion** and the converted object is selected.

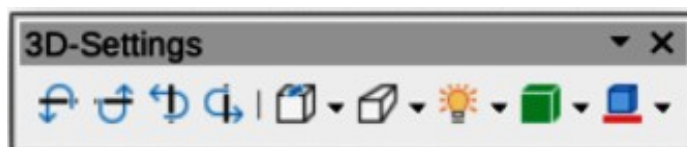

Figure 338: 3D-Settings toolbar

The tools available in **Visible Buttons** for the 3D-Settings toolbar are numbered from left to right when installed on the toolbar.

- | | |
|---------------------|--------------|
| 1) Toggle Extrusion | 6) Depth |
| 2) Tilt Down | 7) Direction |
| 3) Tilt Up | 8) Lighting |
| 4) Tilt Left | 9) Surface |
| 5) Tilt Right | 10) 3D Color |

The following tools on this toolbar have a triangle ▼ on the right of the icon. Click on this triangle to open a drop-down menu giving access to various options as follows:

- **Depth** — 3D extrusion depth – *0cm; 1cm; 2.5cm; 5cm; 10cm; Infinity; Custom*. The measurement unit depends on the settings in **Tools > Options > LibreOffice Draw > General** (macOS **LibreOffice > Preferences > LibreOffice Draw > General**).
- **Direction** — 3D extrusion direction and type – *Parallel; Perspective*.
- **Lighting** — lighting direction and lighting level of 3D extrusion – *Bright; Normal; Dim*.
- **Surface** — surface type of 3D extrusion – *Wire Frame; Matt; Plastic; Metal*.
- **3D Color** — color of 3D extrusion. Select a color from one of the available color palettes.

The Comments toolbar (Figure 340) provides tool for adding, deletion, and navigation of comments in a drawing. To use comments, it is recommended to add the name and initials of all users in **Tools > Options > LibreOffice > User Data** (macOS **LibreOffice > Preferences > LibreOffice > User Data**) so that comments can be easily identified.

The tools available in **Visible Buttons** for the Comments toolbar are numbered from left to right when installed on the toolbar.

Align Objects

- | | |
|---------------------|------------------------|
| 1) Comment | 4) Delete Comment |
| 2) Previous Comment | 5) Delete All Comments |

The Align Objects toolbar (Figure 339) provides tools for aligning several objects in a drawing to improve the visual impact of

The tools available in **Visible Buttons** for the Align Objects toolbar are numbered from left to right when installed on the toolbar.

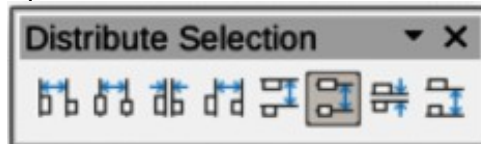

The tools available in **Visible Buttons** for the Distribute Selection toolbar are numbered from left to right when installed on the toolbar.

Figure 341: Distribute Selection toolbar

Distribute Selection

The Distribute Selection toolbar (Figure 341) provides tools for distributing three or more selected objects evenly along the horizontal axis or vertical axis. Also, the spacing between objects can be evenly distributed.

The tools available in **Visible Buttons** for the Distribute Selection toolbar are numbered from left to right when installed on the toolbar.

- | | |
|-------------------------|-----------------------|
| 1) Horizontally Left | 5) Vertically Top |
| 2) Horizontally Center | 6) Vertically Center |
| 3) Horizontally Spacing | 7) Vertically Spacing |
| 4) Horizontally Right | 8) Vertically Bottom |

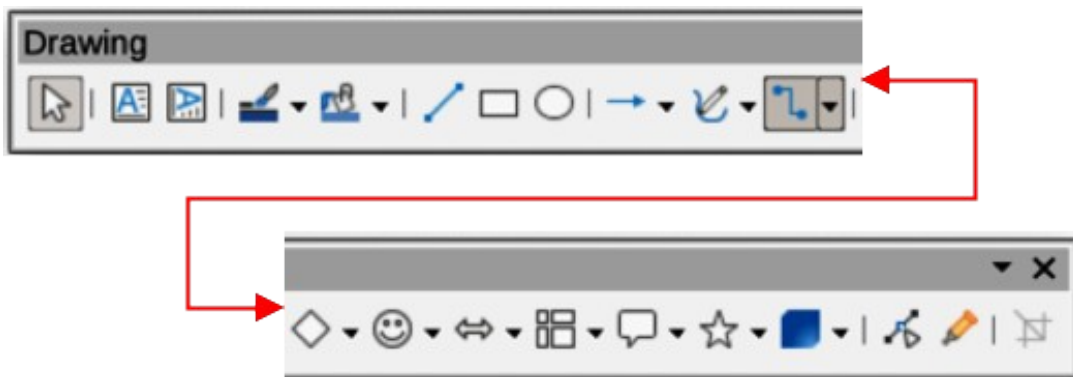

Figure 342: Drawing toolbar

Drawing

The Drawing toolbar (Figure 342) provides the majority of the tools normally used to create graphic objects in a drawing. By default, this toolbar is normally docked on the left side of the Workspace.

Some tool shapes on the Drawing toolbar change depending on the last tool that had previously been selected and used.

- Click on the triangle ▼ to the right of a tool to open a pop-up toolbar. Select the required shape to add to a drawing.

- To create a sub-toolbar, click and drag at the top of the pop-up toolbar to an empty area on the main window. See “Sub-toolbars” on page 361 for more information on the tools available for sub-toolbars.

The tools available in **Visible Buttons** for the Drawing toolbar are numbered from left to right when installed on the toolbar.

- | | |
|---|---|
| 1) Select | 21) Stars and Banners (Star Shapes in Visible Buttons) |
| 2) Zoom & Pan | 22) 3D Objects |
| 3) Zoom | 23) Rotate |
| 4) Text Box | 24) Flip |
| 5) Vertical Text | 25) Align Objects |
| 6) Insert Fontwork | 26) Arrange |
| 7) Line Color | 27) Select at least three objects to distribute (Distribution in visible Buttons) |
| 8) Fill Color | 28) Shadow |
| 9) Line | 29) Crop Image (Crop in Visible Buttons) |
| 10) Rectangle | 30) Filter |
| 11) Ellipse | 31) Points (Edit Points in Visible Buttons) |
| 12) Line Ends with Arrow | 32) Show Gluepoints Function (Gluepoints in Visible Buttons) |
| 13) Lines and Arrows | 33) To Curve |
| 14) Curves and Polygons | 34) To Polygon |
| 15) Connectors | 35) To 3D |
| 16) Basic Shapes | 36) TO 3D Rotation Object |
| 17) Symbol Shapes | 37) Toggle Extrusion |
| 18) Block Arrows (Arrow Shapes in Visible Buttons) | 38) Insert |
| 19) Flowchart (Flowchart Shapes in Visible Buttons) | 39) Controls |
| 20) Callouts (Callout Shapes in Visible Buttons) | |



Figure 343: Edit Points toolbar

Edit Points

The Edit Points toolbar (Figure 353) provides tools for editing the points of a curve or an object that has been converted to a curve. The toolbar only becomes active when an object is selected and one of the following methods is used to open the toolbar:

- Click on **Edit Points** on the Drawing toolbar.
- Use the keyboard shortcut *F8*.

The tools available in **Visible Buttons** for the Edit Points toolbar are numbered from left to right when installed on the toolbar.

- | | |
|---------------------|--------------------------|
| 1) Edit Points | 7) Split Curve |
| 2) Move Points | 8) Corner Point |
| 3) Insert Points | 9) Smooth Transition |
| 4) Delete Points | 10) Symmetric Transition |
| 5) Convert to Curve | 11) Eliminate Points |
| 6) Close Bezier | |

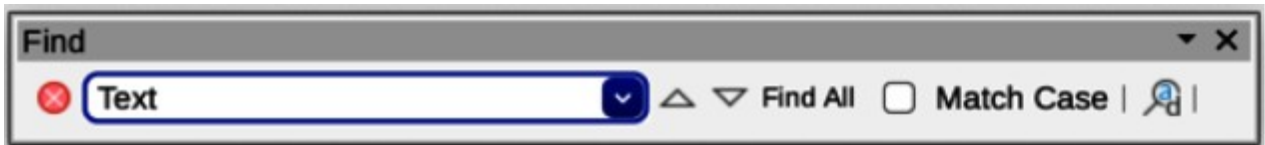

Figure 344: Find toolbar

Find

The Find toolbar (Figure 354) opens by default in the bottom left corner of the Draw main window. This toolbar is normally docked at the bottom left of the Draw main window above the **Status Bar**. However, it can be undocked and made into a floating toolbar.

The tools available in **Visible Buttons** for the Find toolbar are numbered from left to right when installed on the toolbar.

- | | |
|-------------------|-------------------------------|
| 1) Close Find Bar | 5) Find All |
| 2) Find Values | 6) Match Case |
| 3) Find Previous | 7) Find and Replace |
| 4) Find Next | 8) [place holder for message] |

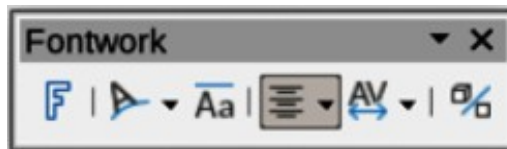

Figure 345: Fontwork toolbar

Fontwork

The Fontwork toolbar (Figure 355) is used creating and formatting graphical text objects in a drawing. This toolbar only becomes active when a Fontwork graphical text object in the drawing has been selected.

Some tools on the Fontwork toolbar have a triangle ▼ to the right of the tool. Click on the triangle to open a pop-up toolbar or drop-down option list.

- **Fontwork Shape** — select a shape for the Fontwork graphical text object from available options.
- **Fontwork Alignment** — select paragraph alignment from available options.
- **Fontwork Character Spacing** — select character spacing from available options.

The tools available in **Visible Buttons** for the Fontwork toolbar are numbered from left to right when installed on the toolbar.

- | | |
|---------------------------------|-------------------------------|
| 1) Insert Fontwork Text | 4) Fontwork Alignment |
| 2) Fontwork Shape | 5) Fontwork Character Spacing |
| 3) Fontwork Same Letter Heights | 6) Toggle Extrusion |



Figure 346: Form Controls toolbar

Form Controls

The Form Controls toolbar (Figure 356) provides the tools for creating an interactive form allowing controls to be added to a form in a drawing (for example a button that opens another drawing or document).

The tools available in **Visible Buttons** for the Form Controls toolbar are numbered from left to right when installed on the toolbar.

- | | |
|--------------------------------|---------------------|
| 1) Select | 15) Formatted Field |
| 2) Design Mode | 16) Date Field |
| 3) Toggle Form Control Wizards | 17) Numerical Field |
| 4) Form Design | 18) Group Box |
| 5) Control Properties | 19) Time Field |
| 6) Form Properties | 20) Currency Field |
| 7) Label | 21) Pattern Field |
| 8) Text Box | 22) Table Control |
| 9) Check Box | 23) Navigation Bar |
| 10) Option Button | 24) Image Control |
| 11) List Box | 25) File Selection |
| 12) Combo Box | 26) Spin Button |
| 13) Push Button | 27) Scrollbar |
| 14) Image Button | |

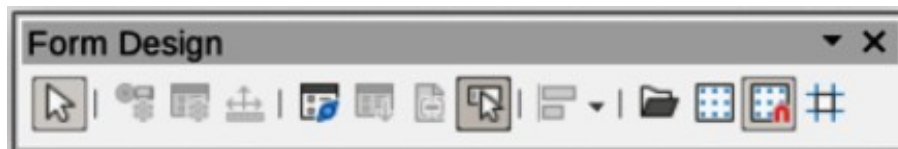

Figure 347: Form Design toolbar

Form Design

The Form Design toolbar (Figure 357) allows editing of a form in **Design Mode**. Controls of the form cannot be activated, or its contents edited, when in **Design Mode**. However, the position and size of the controls can be changed, properties edited, added or deleted in **Design Mode**.

The tools available in **Visible Buttons** for the Form Design toolbar are numbered from left to right when installed on the toolbar.

- | | |
|----------------------------|----------------------------|
| 1) Select | 11) Group |
| 2) Control Properties | 12) Ungroup |
| 3) Form Properties | 13) Enter Group |
| 4) Position and Size | 14) Exit Group |
| 5) Form Navigator | 15) Align Objects |
| 6) Activation Order | 16) Open in Design Mode |
| 7) Add Field | 17) Display Grid |
| 8) Automatic Control Focus | 18) Snap to Grid |
| 9) Bring to Front | 19) Helplines While Moving |
| 10) Send to Back | |



Figure 348: Form Navigation toolbar

Form Navigation

The Form Navigation toolbar (Figure 358) provides tools for editing a database table or controlling the data view. It is normally displayed at the bottom of a document that contains fields linked to a database. It is only active when forms are connected to a database and Figure 358 displays an inactivate toolbar.

The Form Navigation toolbar allows movement within records as well as inserting and deleting records. If data is saved in a form, the changes are transferred to the database. This toolbar also provides tools providing sort, filter, and search functions for data records.

The tools available in **Visible Buttons** for the Form Navigation toolbar are numbered from left to right when installed on the toolbar.

- | | |
|-------------------------|--------------------------|
| 1) Find Record | 13) Delete Record |
| 2) Record | 14) Refresh |
| 3) Absolute Record | 15) Refresh Control |
| 4) Text -> Record | 16) Sort |
| 5) Total No. of Records | 17) Sort Ascending |
| 6) First Record | 18) Sort Descending |
| 7) Previous Record | 19) AutoFilter |
| 8) Next Record | 20) Apply Filter |
| 9) Last Record | 21) Form-Based Filters |
| 10) New Record | 22) Reset Filter/Sort |
| 11) Save Record | 23) Data source as Table |
| 12) Undo: Data entry | |

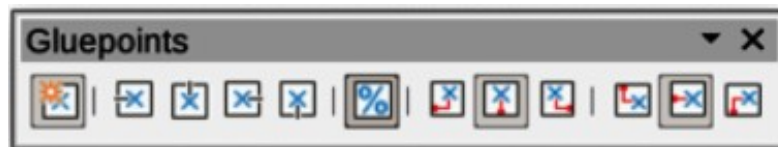

Figure 349: Gluepoints toolbar

Gluepoints

The Gluepoints toolbar (Figure 359) provides tools for inserting a gluepoint or modifying the properties of a gluepoint. A gluepoint is a point where a connector is attached to an object. By default, LibreOffice automatically places a gluepoint at the center of each side of the bounding rectangle for every object created.

The tools available in **Visible Buttons** for the Gluepoints toolbar are numbered from left to right when installed on the toolbar.

- | | |
|--------------------------|--------------------------------|
| 1) Insert Gluepoint | 7) Gluepoint Horizontal Left |
| 2) Exit Direction Left | 8) Gluepoint Horizontal Center |
| 3) Exit Direction Top | 9) Gluepoint Horizontal Right |
| 4) Exit Direction Right | 10) Gluepoint Vertical Top |
| 5) Exit Direction Bottom | 11) Gluepoint Vertical Center |
| 6) Gluepoint Relative | 12) Gluepoint Vertical Bottom |

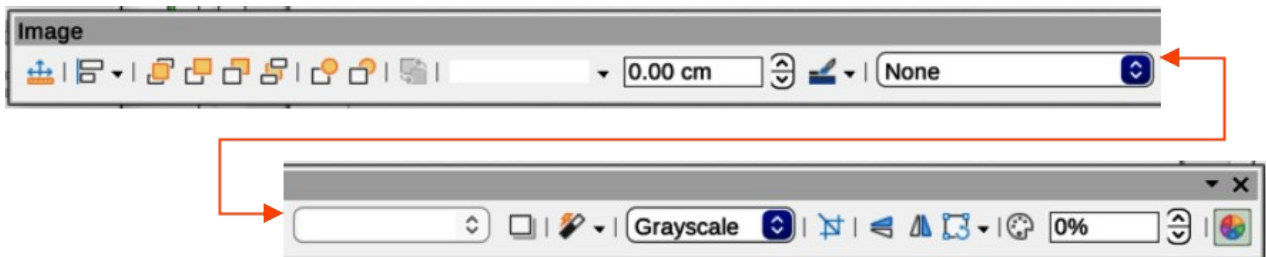

Figure 350: Image toolbar

Image

The Image toolbar (Figure 350) provides tools for editing, modifying, align, repositioning and resizing images. The toolbar only becomes active and available when an image is selected in a drawing. The Image toolbar automatically replaces the Line and Filling toolbar when it activates.

The tools available in **Visible Buttons** for the Image toolbar are numbered from left to right when installed on the toolbar.

- | | |
|------------------------|------------------------|
| 1) Position and Size | 17) Line Style |
| 2) Align Objects | 18) Line Width |
| 3) Left | 19) Line Color |
| 4) Centered | 20) Area Style/Filling |
| 5) Right | 21) Fill Color |
| 6) Top | 22) Shadow |
| 7) Center | 23) Filter |
| 8) Bottom | 24) Image Mode |
| 9) Arrange | 25) Crop |
| 10) Bring to Front | 26) Vertically |
| 11) Bring Forward | 27) Horizontally |
| 12) Send Backward | 28) Transformations |
| 13) Send to Back | 29) Transparency |
| 14) In Front of Object | 30) Color |
| 15) Behind Object | 31) Line |
| 16) Reverse | 32) Area |



Figure 351: Insert toolbar

Insert

The Insert toolbar (Figure 351) provides tools for inserting objects into a drawing such as table, images, media, formulas, charts, and OLE objects.

The tools available in **Visible Buttons** for the Insert toolbar are numbered from left to right when installed on the toolbar.

- | | |
|--------------------------|---|
| 1) New Page | 6) Insert Audio or Video (Media in Visible Buttons) |
| 2) Floating Frame | 7) Formula Object |
| 3) Insert Page from File | 8) Chart |
| 4) Table | 9) OLE Object |
| 5) Image | |

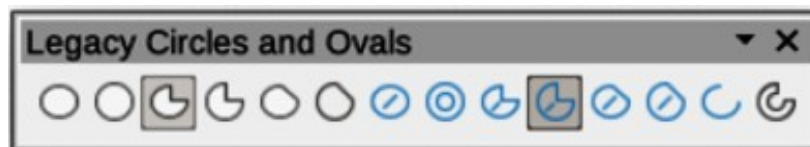

Figure 352: Legacy Circles and Ovals toolbar

Legacy Circles and Ovals

The Legacy Circles and Ovals toolbar (Figure 352) provides tools for inserting different types of circles and ovals into a drawing.

The tools available in **Visible Buttons** for the Legacy Circles and Ovals toolbar are numbered from left to right when installed on the toolbar.

- | | |
|----------------------|-------------------------------|
| 1) Insert Ellipse | 8) Circle, Unfilled |
| 2) Circle | 9) Ellipse Pie, Unfilled |
| 3) Ellipse Pie | 10) Circle Pie, Unfilled |
| 4) Circle Pie | 11) Ellipse Segment, Unfilled |
| 5) Ellipse Segment | 12) Circle Segment, Unfilled |
| 6) Circle Segment | 13) Arc |
| 7) Ellipse, Unfilled | 14) Circle Arc |



Figure 353: Legacy Rectangles toolbar

Legacy Rectangles

The Legacy Rectangles toolbar (Figure 353) provides tools to insert different types of rectangles and squares into a drawing.

The tools available in **Visible Buttons** for the Legacy Rectangles toolbar are numbered from left to right when installed on the toolbar.

- | | |
|-----------------------|--------------------------------|
| 1) Insert Rectangle | 5) Rectangle, Unfilled |
| 2) Square | 6) Square, Unfilled |
| 3) Rectangle, Rounded | 7) Rounded Rectangle, Unfilled |
| 4) Rounded Square | 8) Rounded Square, Unfilled |

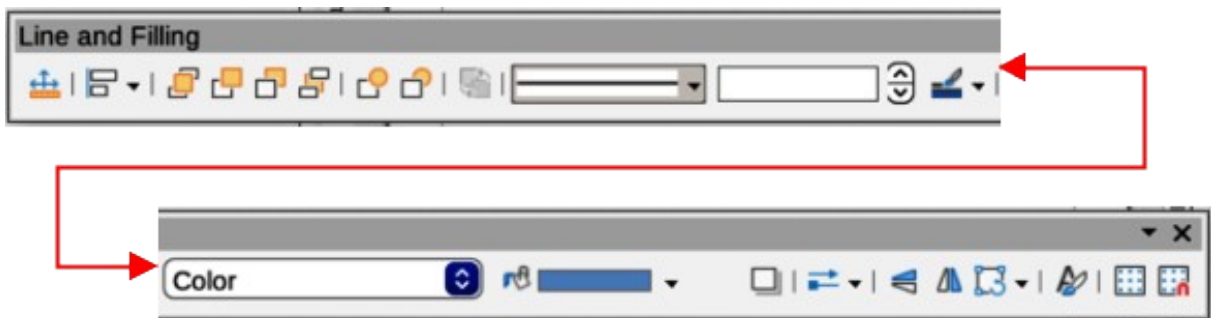

Figure 354: Line and Filling toolbar

Line and Filling

The Line and Filling toolbar (Figure 354) provides tools and drop-down lists for editing lines, arrows, and object borders. Available tools depends on the type of object selected for editing.

The tools available in **Visible Buttons** for the Line and Filling toolbar are numbered from left to right when installed on the toolbar.

- | | |
|----------------------|------------------------|
| 1) Position and Size | 14) In Front of Object |
| 2) Align Objects | 15) Behind Object |
| 3) Left | 16) Reverse |
| 4) Centered | 17) Line Style |
| 5) Right | 18) Line Width |
| 6) Top | 19) Line Color |
| 7) Center | 20) Area Style/Filling |
| 8) Bottom | 21) Fill Color |
| 9) Arrange | 22) Shadow |
| 10) Bring to Front | 23) Arrow Style |
| 11) Bring Forward | 24) Vertically |
| 12) Send Backward | 25) Horizontally |
| 13) Send to Back | 26) Transformations |

- 27) Line
- 28) Area
- 29) 3D Effects
- 30) Image Map
- 31) Animation

- 32) Interaction
- 33) Show the Styles Sidebar
- 34) Display Grid
- 35) Helplines While Moving



Figure 355: Master View toolbar

Master View

The Master View toolbar (Figure 355) provides tools for creating, renaming, deleting, and closing the master view. This toolbar is only active when Draw is in master view mode.

The tools available in **Visible Buttons** for the Master View toolbar are numbered from left to right when installed on the toolbar.

- 1) New Master
- 2) Rename Master
- 3) Delete Master
- 4) Close Master View

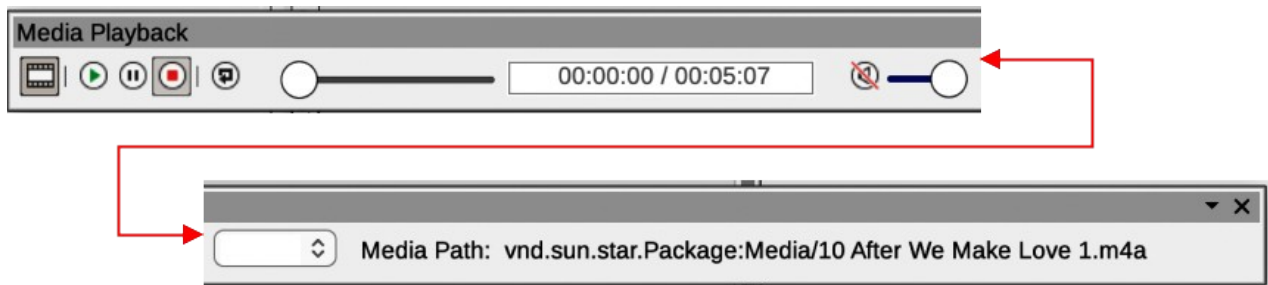

Figure 356: Media Playback toolbar

Media Playback

The Media Playback toolbar (Figure 356) provides the standard tools required for inserting, viewing, playing, and listening to audio and video files. The toolbar only becomes active when a media file is selected. Draw supports many different media formats depending on the computer operating system being used.

The tools available in **Visible Buttons** for the Media Playback toolbar are numbered from left to right when installed on the toolbar.

- 1) Insert Audio or Video
- 2) Play
- 3) Pause
- 4) Stop
- 5) Repeat
- 6) Position
- 7) Mute
- 8) Volume
- 9) View



Figure 357: Options toolbar

Options

The Options toolbar (Figure 357) provides tools for editing various settings for drawings. For example, how objects snap to the grid when being moved or resized.

The tools available in **Visible Buttons** for the Options toolbar are numbered from left to right when installed on the toolbar.

- | | |
|--|-----------------------------------|
| 1) Rotation Mode after Clicking Object | 8) Snap to Object Borders |
| 2) Display Grid | 9) Snap to Object Points |
| 3) Display Snap Guides | 10) Allow Quick Editing |
| 4) Helplines While Moving | 11) Select Text Area Only |
| 5) Snap to Grid | 12) Double-click to edit Text |
| 6) Snap to Snap Guides | 13) Modify Object with Attributes |
| 7) Snap to Page Margins | 14) Exit All Groups |

Redaction

The Redaction toolbar (Figure 358) is used to block portions of a drawing when protecting sensitive information. Redaction helps enterprises and organizations to comply with regulations on confidentiality or privacy.

When a redacted drawing is exported, any redacted portions are removed from the drawing and replaced by redaction blocks of pixels. This prevents any attempt in restoring or copying the original contents. A redacted drawing is often exported as PDF for publication or sharing.

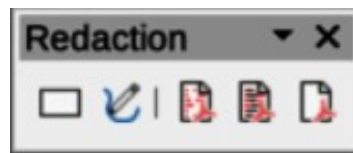

Figure 358: Redaction toolbar

The tools available in **Visible Buttons** for the Redaction toolbar are numbered from left to right when installed on the toolbar.

- | | |
|----------------------------|----------------------------|
| 1) Rectangle | 4) Redacted Export (Black) |
| 2) Freeform | 5) PDF |
| 3) Redacted Export (White) | |



Figure 359: Standard toolbar

Standard

The Standard toolbar (Figure 359) is common to all LibreOffice components providing the most common tools used for creating and editing documents using LibreOffice. The Standard toolbar differs between LibreOffice components to allow for different toolsets used in creating different types of documents.

The tools available in **Visible Buttons** for the Standard toolbar are numbered from left to right when installed on the toolbar.

- | | |
|----------------|--------------|
| 1) Load URL | 6) Save |
| 2) New | 7) Save As |
| 3) Templates | 8) Email |
| 4) Open | 9) Edit Mode |
| 5) Open Remote | 10) Export |

- | | |
|---|---|
| 11) Export Directly as PDF | 35) Insert Hyperlink (Hyperlink in Visible Buttons) |
| 12) Print Directly | 36) Transformations |
| 13) Print | 37) Flip |
| 14) Cut | 38) Position and Size |
| 15) Copy | 39) Align Objects |
| 16) Paste | 40) Distribution |
| 17) Clone Formatting (Clone in Visible Buttons) | 41) Shadow |
| 18) Clear | 42) Crop |
| 19) Undo | 43) Filter |
| 20) Redo | 44) 3D Effects |
| 21) Spelling | 45) Edit Points |
| 22) Auto Spellcheck | 46) Gluepoints |
| 23) Display Grid (Grid in Visible Buttons) | 47) Toggle Extrusion |
| 24) Helplines While Moving | 48) Show Draw Functions (Draw Functions in Visible Buttons) |
| 25) Zoom & Pan | 49) LibreOffice Help |
| 26) Object Zoom | 50) What's That |
| 27) Zoom | 51) Go to First Page |
| 28) Table | 52) Go to Previous Page |
| 29) Insert Image (Image in Visible Buttons) | 53) Go to Next Page |
| 30) Insert Chart (Chart in Visible Buttons) | 54) Go to Last Page |
| 31) Insert Text Box (Text Box in Visible Buttons) | 55) Move Page to Start |
| 32) Insert Special Characters (Symbol in Visible Buttons) | 56) Move Page Up |
| 33) Vertical Text | 57) Move Page Down |
| 34) Insert Fontwork Text | 58) Move Page to End |

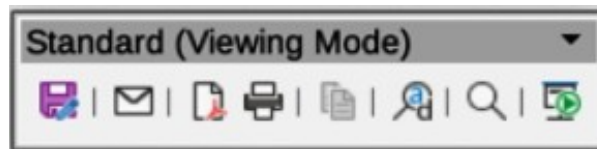

Figure 360: Standard (Viewing Mode) toolbar

Standard (Viewing Mode)

The Standard (Viewing Mode) toolbar (Figure 360) provides tools for saving, editing, and distributing a drawing.

The tools available in **Visible Buttons** for the Standard (Viewing Mode) toolbar are numbered from left to right when installed on the toolbar.

- | | |
|--|---|
| 1) Save As | 6) Export as EPUB (EPUB in Visible Buttons) |
| 2) Toggle Edit Mode (Edit Mode in Visible Buttons) | 7) Print Directly |
| 3) Toggle Read Only Mode (Read Only Mode in Visible Buttons) | 8) Print |
| 4) Attach to Email (Email in Visible Buttons) | 9) Copy |
| 5) Export Directly as PDF | 10) Find and Replace |
| | 11) Zoom |

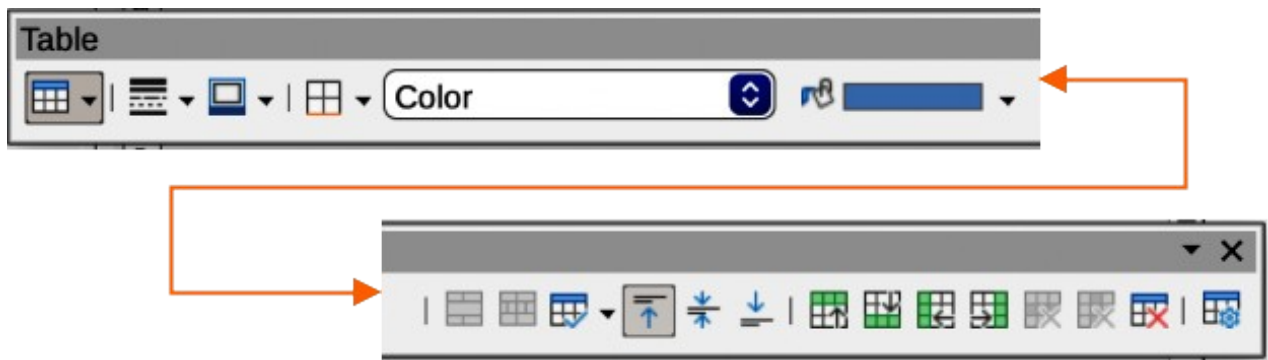

Figure 361: Table toolbar

Table

The Table toolbar (Figure 361) provides tools and options for editing and formatting a table inserted into a drawing. This toolbar only becomes active when a table is selected.

The tools available in **Visible Buttons** for the Table toolbar are numbered from left to right when installed on the toolbar.

- | | |
|---|--------------------------|
| 1) Table | 13) Insert Row Above |
| 2) Border Style | 14) Insert Row Below |
| 3) Border Color | 15) Insert Column Before |
| 4) Borders (Shift to overwrite) | 16) Insert Column After |
| 5) Area Style/Filling | 17) Delete Row |
| 6) Fill Color | 18) Delete Column |
| 7) Merge Cells | 19) Delete Table |
| 8) Split Cells | 20) Select Table |
| 9) Optimize | 21) Select Column |
| 10) Align Top (Top in Visible Buttons) | 22) Select Row |
| 11) Center Vertically (Center in Visible Buttons) | 23) Table Design |
| 12) Align Bottom (Bottom in Visible Buttons) | 24) Table Properties |

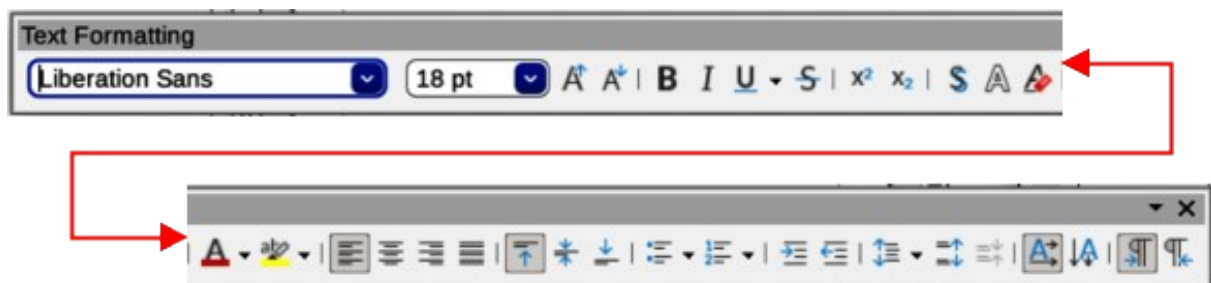

Figure 362: Text Formatting toolbar

Text Formatting

The Text Formatting toolbar (Figure 362) provides tools for formatting text and alignment commands. This toolbar becomes active when text in a text box or graphic object has been selected and it automatically replaces the Line and Filling toolbar.

The tools available in **Visible Buttons** for the Text Formatting toolbar are numbered from left to right when installed on the toolbar.

- | | |
|---|---------------------|
| 1) Font Name | 5) Bold |
| 2) Font Size | 6) Italic |
| 3) Increase Font Size (Increase in Visible Buttons) | 7) Underline |
| 4) Decrease Font Size (Decrease in Visible Buttons) | 8) Double Underline |
| | 9) Strikethrough |
| | 10) Overline |

- | | |
|---|--|
| 11) Superscript | 26) Align Right (Right in Visible Buttons) |
| 12) Subscript | 27) Justified |
| 13) Toggle Shadow (Shadow in Visible Buttons) | 28) Align Top (Top in Visible Buttons) |
| 14) Apply outline attribute to font. Not all fonts implement this attribute. (Outline Font Effect in Visible Buttons) | 29) Center Vertically (Center in Visible Buttons) |
| 15) Clear | 30) Align Bottom (Bottom in Visible Buttons) |
| 16) lowercase | 31) Set Line Spacing (Line Spacing in Visible Buttons) |
| 17) UPPERCASE | 32) Character Spacing |
| 18) Small capitals | 33) Increase Paragraph Spacing (Increase in Visible Buttons) |
| 19) Font Color | 34) Decrease Paragraph Spacing (Decrease in Visible Buttons) |
| 20) Character Highlighting Color | 35) Text direction from left to right |
| 21) Toggle Unordered List (Unordered List in Visible Buttons) | 36) Text direction from top to bottom |
| 22) Toggle Ordered List (Ordered List in Visible Buttons) | 37) Left-To-Right |
| 23) Outline Format | 38) Right-To-Left |
| 24) Align Left (Left in Visible Buttons) | 39) Select All |
| 25) Align Center (Center in Visible Buttons) | 40) Character |
| | 41) Paragraph |

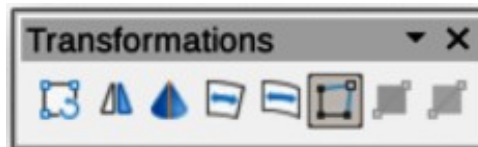

Figure 363: Transformations toolbar

Transformations

The Transformations toolbar (Figure 363) provides tools for modifying the shape, orientation, or fill of selected objects.

The tools available in **Visible Buttons** for the Transformations toolbar are numbered from left to right when installed on the toolbar.

- | | |
|--------------------------------|---|
| 1) Rotate | 6) Distort |
| 2) Flip | 7) Interactive transparency tool (Transparency tool in Visible Buttons) |
| 3) In 3D Rotation Object | 8) Interactive gradient tool (Gradient tool in Visible Buttons) |
| 4) Set in Circle (perspective) | |
| 5) Set to circle (slant) | |



Figure 364: Zoom toolbar

Zoom

The Zoom toolbar (Figure 364) provides tools for reducing or enlarging the screen display of the current drawing.

The tools available in **Visible Buttons** for the Zoom toolbar are numbered from left to right when installed on the toolbar.

- | | |
|-------------|------------------|
| 1) Zoom In | 3) 100% |
| 2) Zoom Out | 4) Zoom Previous |

- | | |
|--|----------------|
| 5) Zoom Next | 9) Object Zoom |
| 6) Entire Page | 10) Zoom & Pan |
| 7) Page Width | 11) Shift |
| 8) Optimal View (Optimal in Visible Buttons) | |

Sub-toolbars



Figure 365: 3D-Objects sub-toolbar

3D-Objects

Clicking on the triangle ▼ to the right of **3D-Objects** on the Drawing toolbar opens the 3D-Objects sub-toolbar (Figure 365). Select the required 3D object for insertion into a drawing.

✓ Note

The 3D-Objects sub-toolbar is identical to the 3D-Objects toolbar available at **View > Toolbars** on the Menu bar.

The tools available in **Visible Buttons** for the 3D-Objects sub-toolbar are numbered from left to right when installed on the sub-toolbar.

- | | |
|-------------|----------------|
| 1) Cube | 5) Pyramid |
| 2) Sphere | 6) Torus |
| 3) Cylinder | 7) Shell |
| 4) Cone | 8) Half Sphere |

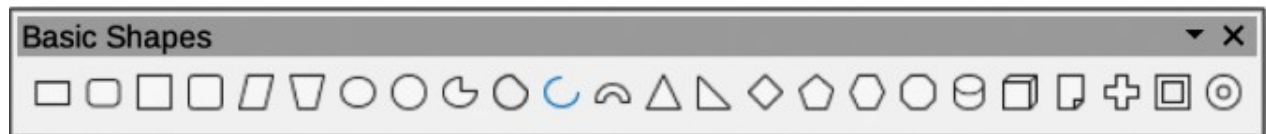

Figure 366: Basic Shapes sub-toolbar

Basic Shapes

Clicking on the triangle ▼ to the right of **Basic Shapes** on the Drawing toolbar opens the Basic Shapes sub-toolbar (Figure 366). Select the required basic shape for insertion into a drawing.

The tools available in **Visible Buttons** for the Basic Shapes sub-toolbar are numbered from left to right when installed on the sub-toolbar.

- | | |
|-----------------------|------------------------|
| 1) Rectangle | 13) Isosceles Triangle |
| 2) Rectangle, Rounded | 14) Right Triangle |
| 3) Square | 15) Diamond |
| 4) Square, Rounded | 16) Regular Pentagon |
| 5) Parallelogram | 17) Hexagon |
| 6) Trapezoid | 18) Octagon |
| 7) Ellipse | 19) Cylinder |
| 8) Circle | 20) Cube |
| 9) Circle Pie | 21) Folded Corner |
| 10) Circle Segment | 22) Cross |
| 11) Arc | 23) Frame |
| 12) Block Arc | 24) Ring |



Figure 367: Block Arrows sub-toolbar

Block Arrows

Clicking on the triangle ▼ to the right of **Block Arrows** on the Drawing toolbar opens the Block Arrows sub-toolbar (Figure 367). Select the required block arrow for insertion into a drawing.

The tools available in **Visible Buttons** for the Block Arrows sub-toolbar are numbered from left to right when installed on the sub-toolbar.

- | | |
|-------------------------|----------------------------------|
| 1) Right Arrow | 14) Pentagon |
| 2) Left Arrow | 15) Striped Right Arrow |
| 3) Down Arrow | 16) Up, right and Down Arrow |
| 4) Up Arrow | 17) Notched Right Arrow |
| 5) Left and Right Arrow | 18) Up and Right Arrow |
| 6) Up and Down Arrow | 19) Right Arrow Callout |
| 7) Circular Arrow | 20) Left Arrow Callout |
| 8) S-shaped Arrow | 21) Down Arrow Callout |
| 9) Split Arrow | 22) Up Arrow Callout |
| 10) Right or Left Arrow | 23) Left and Right Arrow Callout |
| 11) 4-way Arrow | 24) Up and Down Arrow Callout |
| 12) Corner Right Arrow | 25) 4-way Arrow Callout |
| 13) Chevron | 26) Up and Right Arrow Callout |



Figure 368: Callouts sub-toolbar

Callouts

Clicking on the triangle ▼ to the right of **Callouts** on the Drawing toolbar to open the Callouts sub-toolbar (Figure 368). Select the required callout for insertion into a drawing.

The tools available in **Visible Buttons** for the Callouts sub-toolbar are numbered from left to right when installed on the sub-toolbar.

- | | |
|--------------------------------|-------------------|
| 1) Rectangular Callout | 5) Line Callout 1 |
| 2) Rounded Rectangular Callout | 6) Line Callout 2 |
| 3) Round Callout | 7) Line Callout 3 |
| 4) Cloud | |

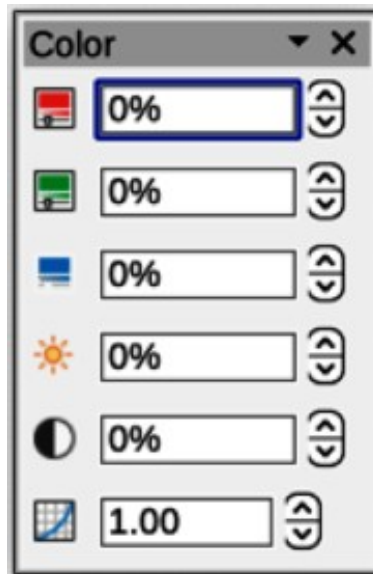

Figure 369: Color sub-toolbar

Color

The Color sub-toolbar (Figure 369) provides tools for editing the color properties of a selected object. After selecting an image or graphic to open the Image toolbar, click on **Color** on the Image toolbar opening the Color sub-toolbar.

The tools available on the Color sub-toolbar are as follows:

- **Red** — specifies the proportion of red RGB color components for the selected graphic object. Values from -100% (no red) to +100% (full red) are possible.
- **Green** — specifies the proportion of green RGB color components for the selected graphic object. Values from -100% (no green) to +100% (full green) are possible.
- **Blue** — specifies the proportion of blue RGB color components for the selected graphic. Values from -100% (no blue) to +100% (full blue) are possible.
- **Brightness** — specifies the brightness for the selected graphic object. Values from -100% (only black) to +100% (only white) are possible.
- **Contrast** — specifies the contrast for viewing the selected graphic image. Values from -100% (no contrast at all) to +100% (full contrast) are possible.
- **Gamma** — specifies the gamma value for the view of the selected object, which affects the brightness of the mid-tone values. Values from 0.10 (minimum Gamma) to 10 (maximum Gamma) are possible.



Figure 370: Connectors sub-toolbar

Connectors

Clicking on the triangle ▼ to the right of **Connectors** on the Drawing toolbar opens the Connectors sub-toolbar (Figure 370). Select the required connector for insertion into a drawing.

The tools available in **Visible Buttons** for the Connectors sub-toolbar are numbered from left to right when installed on the sub-toolbar.

- | | |
|--|---|
| 1) Connector Ends with Arrow | 13) Connector Ends with Circle |
| 2) Straight Connector Ends with Arrow | 14) Straight Connector Ends with Circle |
| 3) Curved Connector Ends with Arrow | 15) Curved Connector Ends with Circle |
| 4) Line Connector Ends with Arrow | 16) Line Connector Ends with Circle |
| 5) Connector | 17) Connector Starts with Circle |
| 6) Straight Connector | 18) Straight Connector starts with Circle |
| 7) Curved Connector | 19) Curved Connector Starts with Circle |
| 8) Line Connector | 20) Line Connector Starts with Circle |
| 9) Connector Starts with Arrow | 21) Connector with Circles |
| 10) Straight Connector starts with Arrow | 22) Straight Connector with Circle |
| 11) Curved Connector Starts with Arrow | 23) Curved Connector with Circle |
| 12) Line Connector Starts Arrow | 24) Line Connector with Circle |



Figure 371: Curves and Polygons sub-toolbar

Curves and Polygons

Clicking on the triangle ▼ to the right of **Curves and Polygons** on the Drawing toolbar opens the Curves and Polygons sub-toolbar (Figure 371). Select the required curve or polygon for insertion into a drawing.

The tools available in **Visible Buttons** for the Curves and Polygons sub-toolbar are numbered from left to right when installed on the sub-toolbar.

- | | |
|--------------------------|------------------|
| 1) Curve, Filled | 5) Curve |
| 2) Polygon, Filled | 6) Polygon |
| 3) Polygon (45°), Filled | 7) Polygon (45°) |
| 4) Freeform Line, Filled | 8) Freeform Line |



Figure 372: Flowchart sub-toolbar

Flowchart

Clicking on the triangle ▼ to the right of **Flowchart** on the Drawing toolbar opens the Flowchart sub-toolbar (Figure 372). Select the required flowchart shape for insertion into a drawing.

The tools available in **Visible Buttons** for the Flowchart sub-toolbar are numbered from left to right when installed on the sub-toolbar.

- | | |
|----------------------------------|-----------------------------------|
| 1) Flowchart: Process | 12) Flowchart: Manual Operation |
| 2) Flowchart: Alternate Process | 13) Flowchart: Connector |
| 3) Flowchart: Decision | 14) Flowchart: Off-page Connector |
| 4) Flowchart: Data | 15) Flowchart: Card |
| 5) Flowchart: Predefined Process | 16) Flowchart: Punched Tape |
| 6) Flowchart: Internal Storage | 17) Flowchart: Summing Junction |
| 7) Flowchart: Document | 18) Flowchart: Or |
| 8) Flowchart: Multidocument | 19) Flowchart: Collate |
| 9) Flowchart: Terminator | 20) Flowchart: Sort |
| 10) Flowchart: Preparation | 21) Flowchart: Extract |
| 11) Flowchart: Manual Input | 22) Flowchart: Merge |

- | | |
|----------------------------------|--------------------------------------|
| 23) Flowchart: Stored Data | 26) Flowchart: Magnetic Disc |
| 24) Flowchart: Delay | 27) Flowchart: Direct Access Storage |
| 25) Flowchart: Sequential Access | 28) Flowchart: Display |



Figure 373: Image Filter sub-toolbar

Image Filter

Clicking on the triangle ▼ to the right of **Filter** on the Image toolbar opens the Image Filter sub-toolbar (Figure 373). Select the required filter to change how an image appears on the display.

The filters available on the Image Filter sub-toolbar are as follows:

- **Invert** — inverts the color values of a color image, or the brightness values of a greyscale image. Apply the filter again to revert the effect.
- **Smooth** — softens or blurs the image by applying a low pass filter.
- **Sharpen** — sharpens the image by applying a high pass filter.
- **Remove Noise** — removes noise by applying a median filter.
- **Solarization** — opens a dialogue box for defining solarization. Solarization refers to an effect that looks like what can happen when there is too much light during photo development. The colors become partly inverted.
- **Aging** — all pixels are set to their gray values, and then the green and blue color channels are reduced by the amount specified. The red color channel is not changed.
- **Posterize** — opens a dialogue box to determine the number of poster colors. This effect is based on the reduction of the number of colors. It makes photos look like paintings.
- **Pop Art** — converts an image to a pop-art format.
- **Charcoal Sketch** — displays the image as a charcoal sketch. The contours of the image are drawn in black, and the original colors are suppressed.
- **Relief** — displays a dialogue box for creating reliefs. Selecting the position of the imaginary light source determines the type of shadow created, and how the graphic image looks in relief.
- **Mosaic** — joins small groups of pixels into rectangular areas of the same color. The larger the individual rectangles are, the fewer details the graphic image has.



Figure 374: Lines and Arrows sub-toolbar

Lines and Arrows

Clicking on the triangle ▼ to the right of **Lines and Arrows** on the Drawing toolbar opens the Lines and Arrows sub-toolbar (Figure 374). Select the required line or arrow for insertion into a drawing.

The tools available in **Visible Buttons** for the Lines and Arrows sub-toolbar are numbered from left to right when installed on the sub-toolbar.

- | | |
|---------------------------|---------------------------|
| 1) Line Ends with Arrow | 6) Line with Arrow/Circle |
| 2) Line with Circle/Arrow | 7) Line with Arrow/Square |
| 3) Line with Square/Arrow | 8) Insert Line |
| 4) Line with Arrows | 9) Dimension Line |
| 5) Line Starts with Arrow | 10) Line (45°) |



Figure 375: Stars and Banners sub-toolbar

Stars and Banners

Clicking on the triangle ▼ to the right of **Stars and Banners** on the Drawing toolbar opens the Stars and Banners sub-toolbar (Figure 375). Select the required star or arrow for insertion into a drawing.

The tools available in **Visible Buttons** for the Stars and Banners sub-toolbar are numbered from left to right when installed on the sub-toolbar.

- | | |
|------------------|---------------------------|
| 1) 4-Point Star | 7) Explosion |
| 2) 5-Point Star | 8) Vertical Scroll |
| 3) 6-Point Star | 9) Horizontal Scroll |
| 4) 8-Point Star | 10) Signet |
| 5) 12-Point Star | 11) Doorplate |
| 6) 24-Point Star | 12) 6-Point Star, Concave |



Figure 376: Symbol Shapes sub-toolbar

Symbol Shapes

Clicking on the triangle ▼ to the right of **Symbol Shapes** on the Drawing toolbar to open the Symbol Shapes sub-toolbar (Figure 376). Select the required symbol shape for insertion into a drawing.

The tools available in **Visible Buttons** for the Symbol Shapes sub-toolbar are numbered from left to right when installed on the sub-toolbar.

- | | |
|-------------------|--------------------|
| 1) Smiley Face | 10) Square Bevel |
| 2) Heart | 11) Octagon Bevel |
| 3) Sun | 12) Diamond Bevel |
| 4) Moon | 13) Double Bracket |
| 5) Cloud | 14) Left Bracket |
| 6) Lightning Bolt | 15) Right Bracket |
| 7) Flower | 16) Double Brace |
| 8) Prohibited | 17) Left Brace |
| 9) Puzzle | 18) Right Brace |



Draw Guide

Working With Vector Graphics

About this book:

This book covers the main features of Draw, the vector graphics component of LibreOffice. Using Draw, a wide variety of graphical images can be created.

Vector graphics store and display a picture as simple geometric elements such as lines, circles, and polygons rather than as a collection of pixels (points on the screen). This permits simpler storage and supports precise scaling of the picture elements.

Draw is fully integrated into LibreOffice. This simplifies exchanging graphics with Writer, Calc, and Impress. Images can be exported in many formats for use in other programs.

About the authors:

This book was written by volunteers from the LibreOffice community. Profits from the sales of the printed edition are used to benefit the community.

A PDF version of this book can be downloaded free from:
<https://documentation.libreoffice.org/en/>

About LibreOffice:

LibreOffice is the free, libre, and open source personal productivity suite from The Documentation Foundation. It runs on Windows, macOS, and GNU/Linux. Support and documentation is free from a large, dedicated community of users, contributors, and developers.

Get involved as a volunteer and work in many areas: development, quality assurance, documentation, translation, user support, and more.

Download LibreOffice for free from:
<https://libreoffice.org/downloads/>

For commercial use:

Work with certified LibreOffice professionals for any business needs, from deployment or conversion from other office suits, staff training, or custom development needs.

For information on professional support services, go to
<https://www.libreoffice.org/get-help/professional-support/>