



**LibreOffice**  
The Document Foundation

## Getting Started Guide

### *Chapter 9*

### *Getting Started with Math*

*LibreOffice's Equation Editor*

## Copyright

---

This document is Copyright © 2010 by its contributors as listed below. You may distribute it and/or modify it under the terms of either the GNU General Public License (<http://www.gnu.org/licenses/gpl.html>), version 3 or later, or the Creative Commons Attribution License (<http://creativecommons.org/licenses/by/3.0/>), version 3.0 or later.

All trademarks within this guide belong to their legitimate owners.

## Contributors

Ron Faile Jr.

## Feedback

Please direct any comments or suggestions about this document to:  
[documentation@libreoffice.org](mailto:documentation@libreoffice.org)

## Acknowledgments

This chapter is based on Chapter 9 of *Getting Started with OpenOffice.org*. The contributors to that chapter are:

Daniel Carrera  
Agnes Belzunce  
Peter Kupfer  
Ian Laurenson  
Janet M. Swisher  
Jean Hollis Weber

## Publication date and software version

Published 16 December 2010. Based on LibreOffice 3.3.

## Note for Mac users

---

Some keystrokes and menu items are different on a Mac from those used in Windows and Linux. The table below gives some common substitutions for the instructions in this chapter. For a more detailed list, see the application Help.

<i>Windows/Linux</i>	<i>Mac equivalent</i>	<i>Effect</i>
<b>Tools</b> → <b>Options</b> menu selection	<b>LibreOffice</b> → <b>Preferences</b>	Access setup options
<i>Right-click</i>	<i>Control+click</i>	Open context menu
<i>Ctrl (Control)</i>	⌘ ( <i>Command</i> )	Used with other keys
<i>F5</i>	<i>Shift+⌘+F5</i>	Open the Navigator
<i>F11</i>	⌘+T	Open Styles & Formatting window

# Contents

---

Copyright.....	2
Note for Mac users.....	2
What is Math?.....	4
Getting started.....	4
Entering a formula.....	5
The Elements window.....	5
Right-click menu.....	7
Markup.....	7
Greek characters.....	8
Customizations.....	10
Formula editor as a floating window.....	10
How can I make a formula bigger?.....	11
Formula layout.....	12
Brackets are your friends.....	12
Equations over more than one line.....	12
How do I add limits to my sum/integral?.....	12
Brackets with matrices look ugly!.....	13
How do I make a derivative?.....	14
How do I align my equations at the equals sign?.....	14
Numbering equations.....	15

## What is Math?

Math is LibreOffice's component for writing mathematical equations. It is most commonly used as an equation editor for text documents, but it can also be used with other types of documents or stand-alone. When used inside Writer, the equation is treated as an object inside the text document.

### Note

The equation editor is for writing equations in symbolic form, as in equation 1. If you want to evaluate a numeric value, see the *Calc Guide*.

$$\frac{df(x)}{dx} = \ln(x) + \tan^{-1}(x^2) \quad (1)$$

## Getting started

To insert an equation, choose **Insert** → **Object** → **Formula**.

The equation editor opens at the bottom of the screen, and the floating Elements window (called “Selection” before Math 3.2 and “Formula Elements” in Math 3.2) may appear. You will also see a small box with a gray border in your document, where the formula will be displayed.

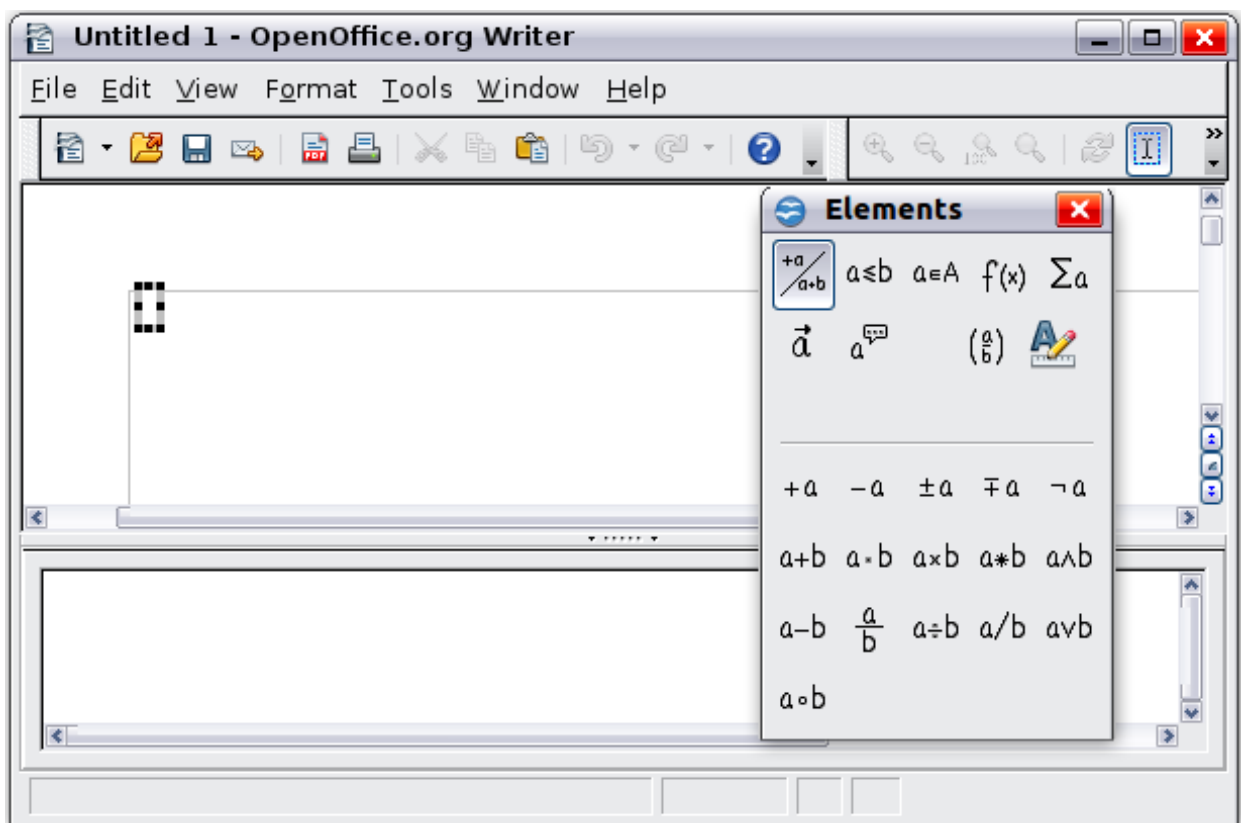

Figure 1. Equation Editor, Elements window, and location of resulting equation.

## Entering a formula

The equation editor uses a markup language to represent formulas. For example, `%beta` creates the Greek character beta ( $\beta$ ). This markup is designed to read similar to English whenever possible. For example, `a over b` produces a fraction:  $\frac{a}{b}$ .

You can enter a formula in three ways:

- Select a symbol from the Elements window.
- Right-click on the equation editor and select the symbol from the context menu.
- Type markup in the equation editor.

The context menu and the Elements window insert the markup corresponding to a symbol. This provides a convenient way to learn the Math markup.

### Note

Click on the document body to exit the formula editor.  
Double-click on a formula to enter the formula editor again.

## The Elements window

The simplest method for entering a formula is to use the Elements window.

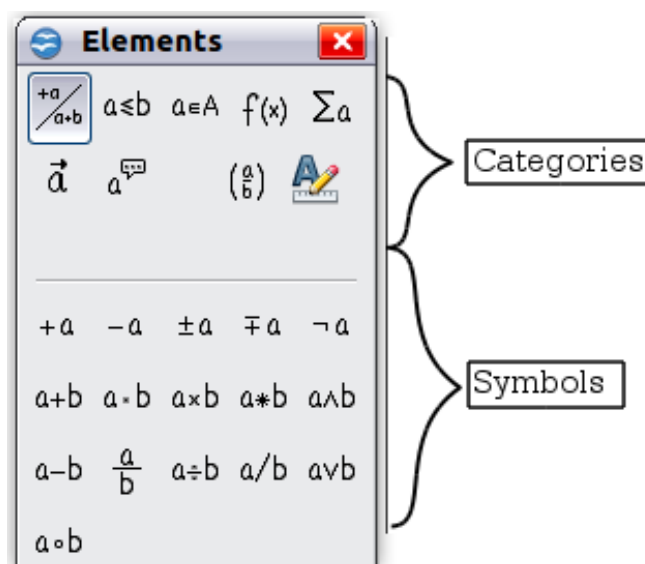

Figure 2. Symbols are divided into categories

The Elements window is divided into two main parts.

- The **top** shows the symbol categories. Click on these to change the list of symbols.
- The **bottom** shows the symbols available in the current category.

### Tip

You can hide or show the Elements window with **View** → **Elements**.

### Example 1: $5 \times 4$

For this example we will enter a simple formula:  $5 \times 4$ . On the Elements window:

- 1) Select the top-left button of the categories (top) section.

2) Click on the multiplication symbol.

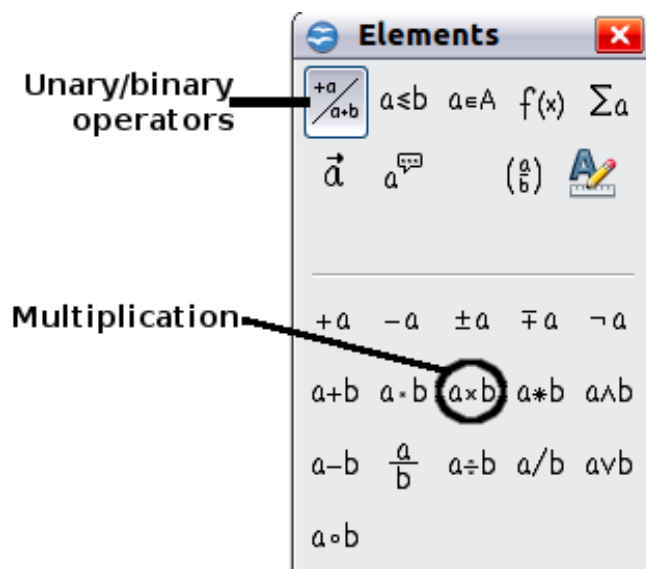

Figure 3. Selecting the multiplication symbol

When you select the multiplication symbol on the Elements window, two things happen:

- The equation editor shows the markup:  $\langle ? \rangle \text{ times } \langle ? \rangle$
- The body of the document shows a gray box like this:  $\square \times \square$

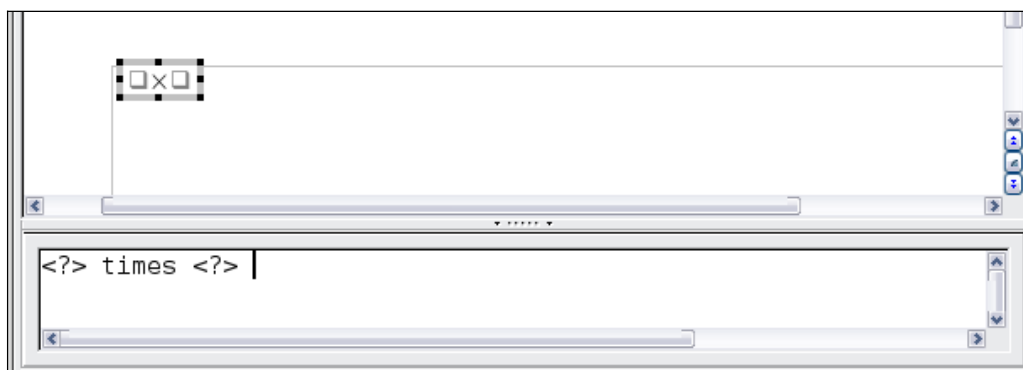

Figure 4. Result of selecting the multiplication symbol

The  $\langle ? \rangle$  symbols shown in Figure 4 are placeholders that you can replace by other text, for example 5 and 4. The equation will update automatically, and the result should resemble Figure 5.

**Tip**

To keep the equation from updating automatically, choose **View** → **AutoUpdate display** from the menu bar. To update a formula manually, press **F9** or choose **View** → **Update**.

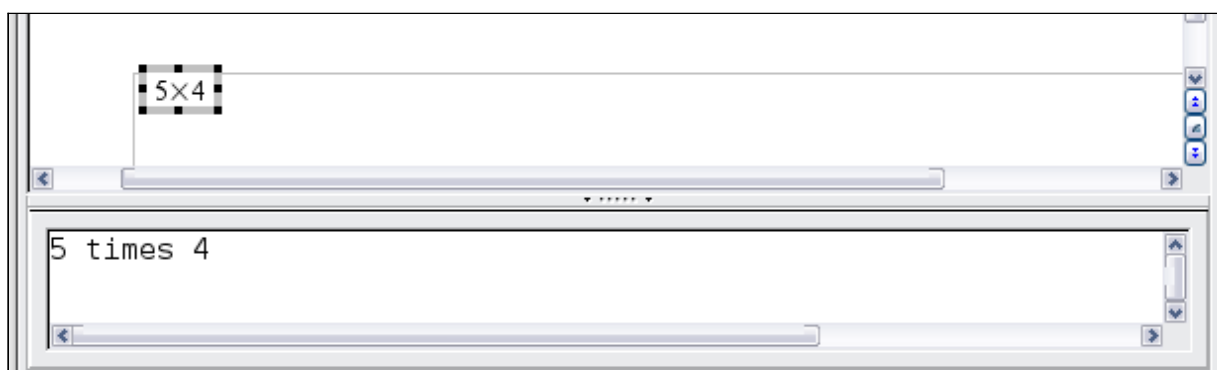

Figure 5. Result of entering 5 and 4 next to the times operator

## Right-click menu

Another way to access mathematical symbols is to right-click on the equation editor. This pops up the menu shown in Figure 6. The items in this menu correspond exactly to those in the Elements window.

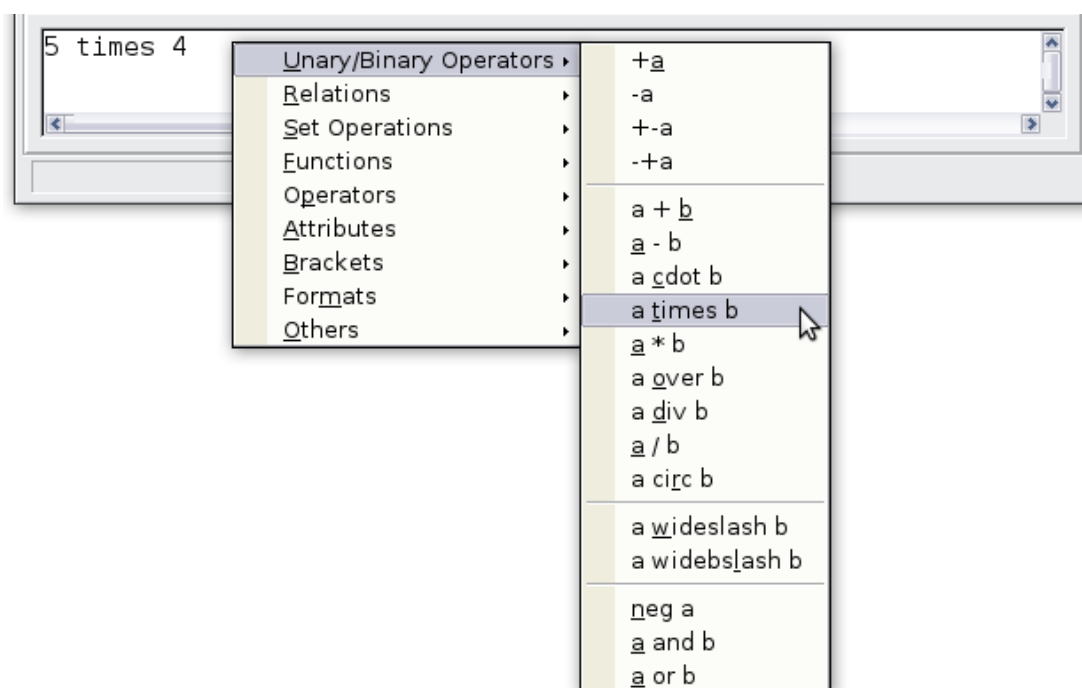

Figure 6. Right-click menu

## Markup

You can type the markup directly in the equation editor. For example, you can type 5 times 4 to obtain  $5 \times 4$ . If you know the markup, this can be the fastest way to enter a formula.

### Tip

The formula markup resembles the way the formula reads in English.

Below is a short list of common equations and their corresponding markup.

<b>Display</b>	<b>Command</b>	<b>Display</b>	<b>Command</b>
$a=b$	a = b	$\sqrt{a}$	sqrt {a}
$a^2$	a^2	$a_n$	a_n
$\int f(x) dx$	int f(x) dx	$\sum a_n$	sum a_n
$a \leq b$	a <= b	$\infty$	infinity
$a \times b$	a times b	$x \cdot y$	x cdot y

## Greek characters

Greek characters (  $\alpha$  ,  $\beta$  ,  $\gamma$  ,  $\theta$  , and so on) are common in mathematical formulas. *These characters are not available in the Elements window or on the right-click menu.* Fortunately, the markup for Greek characters is simple: Type a % sign followed the name of the character, in English. (In localized versions of LibreOffice, these names are localized.)

- To write a *lowercase* character, type the name of the character in lowercase.
- To write an *uppercase* character, type the name of the character in uppercase.

See the table below for some examples.

<b>Lowercase</b>	<b>Uppercase</b>
%alpha → $\alpha$	%ALPHA → $A$
%beta → $\beta$	%BETA → $B$
%gamma → $\gamma$	%GAMMA → $\Gamma$
%psi → $\psi$	%PSI → $\Psi$
%phi → $\phi$	%PHI → $\Phi$
%theta → $\theta$	%THETA → $\Theta$

### Note

A complete table of Greek characters is provided in the *Math Guide*.

Another way to enter Greek characters is by using the Symbols catalog window. Choose **Tools** → **Catalog**. Under *Symbol set*, select **Greek** and double-click on a Greek letter from the list. The markup name of the character is shown below the list window.



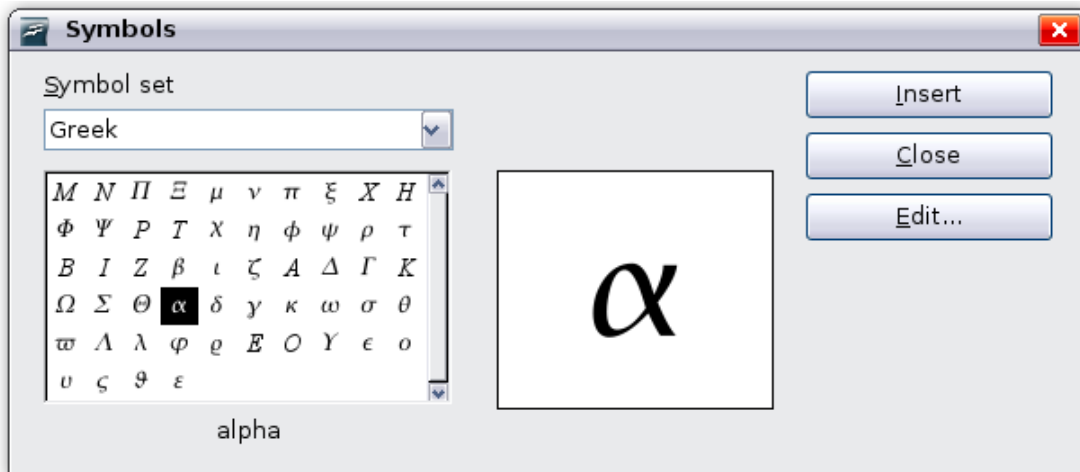

Figure 7. Symbols catalog—used for entering Greek characters and some special symbols.

**Example 2:**  $\pi \simeq 3.14159$

For this example we will suppose that:

- We want to enter the above formula (the value of pi rounded to 5 decimal places).
- We know the name of the Greek character (pi).
- But we do not know the markup associated with the  $\simeq$  symbol.

**Step 1:** Type % followed by the text pi. This displays the Greek character  $\pi$ .

**Step 2:** Open the Elements window (**View** → **Elements**).

**Step 3:** The  $\simeq$  symbol is a relation, so we click on the Relations button. If you hover the mouse over this button you see the tooltip *Relations* (Figure 8).

Figure 9 shows the Elements window after clicking the Relations button. The symbol we want is circled.

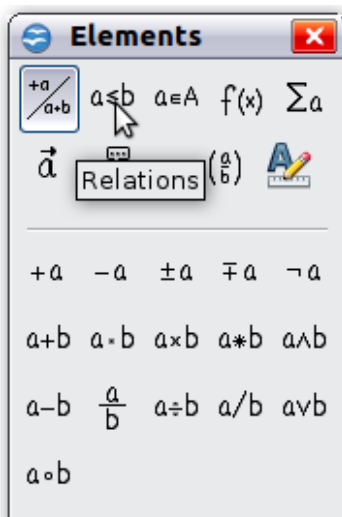

Figure 8. Tooltip indicates the Relations button

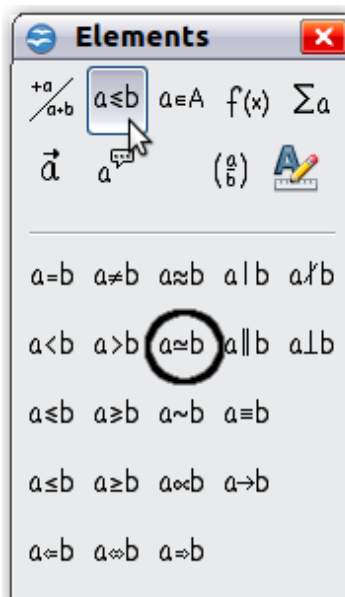

Figure 9. After selecting Relations

**Step 4:** Click on the  $a \simeq b$  symbol. The equation editor now shows the markup `%pi<?> simeq <?>`.

**Step 5:** Delete the `<?>` text and add 3.14159 at the end of the equation. We end up with the markup `%pi simeq 3.14159`. The result is shown in Figure 10.

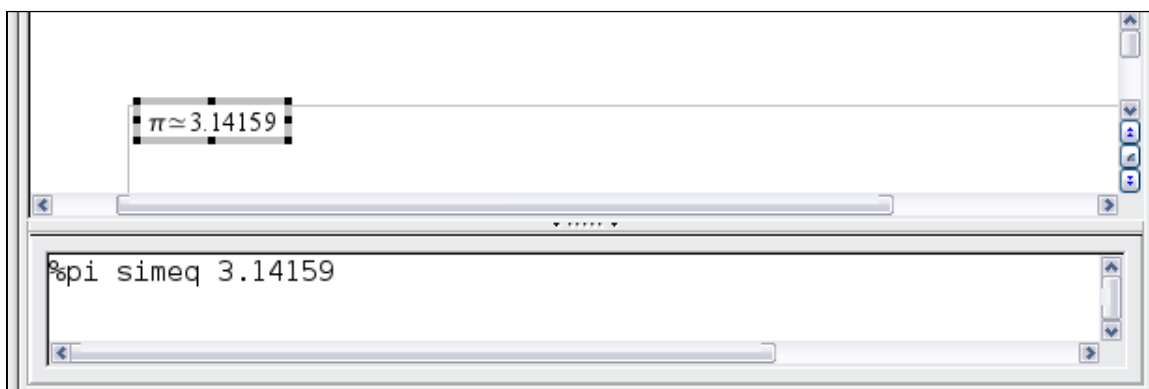

Figure 10. Final result

## Customizations

---

### Formula editor as a floating window

The formula editor can cover a large part of the Writer window. To turn the formula editor into a floating window, do this:

- 1) Hover the mouse over the editor frame, as shown in Figure 11.
- 2) Hold down the *Control* key and double-click.

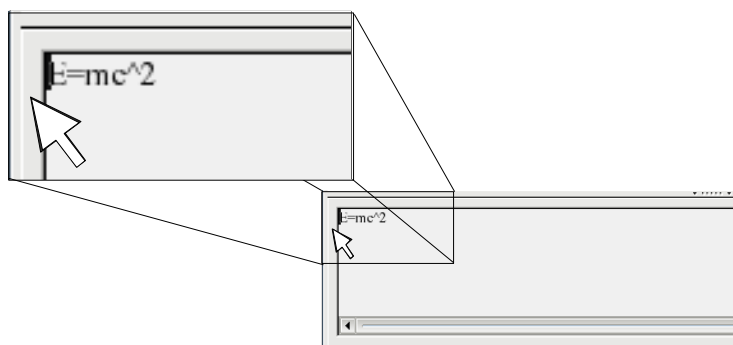

Figure 11. Hold down the *Control* key and double-click on the border of the formula editor to turn it into a floating window.

Figure 12 shows the result. You can dock the floating window again by using the same steps. Hold down the *Control* key and double-click the window frame.



Figure 12. Formula editor as a floating window

## How can I make a formula bigger?

This is one of the most common questions people ask about Math. The answer is simple, but not intuitive:

- 1) Start the formula editor and choose **Format** → **Font size**.

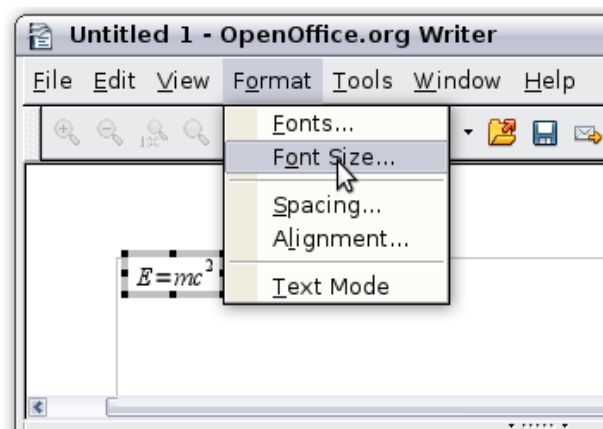

Figure 13. Changing the font size for a formula

- 2) Select a larger font size under *Base size* (top-most entry).

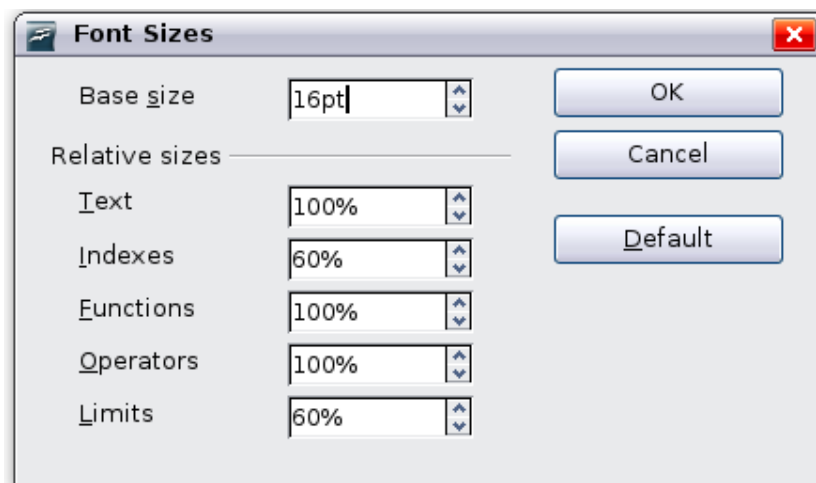

Figure 14. Edit Base size (top) to make a formula bigger.

The result of this change is illustrated in Figure 15.

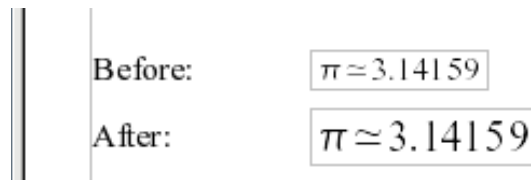

Figure 15. Result of changing the base font size.

## Formula layout

---

The most difficult part of using Math comes when writing complicated formulas. This section provides some advice.

### Brackets are your friends

Math knows nothing about order of operation. You must use brackets to state the order of operations explicitly. Consider the following example.

Markup	Result
2 over x + 1	$\frac{2}{x} + 1$
2 over {x + 1}	$\frac{2}{x+1}$

### Equations over more than one line

Suppose you want to type an equation covering more than one line. For example:  $x=3$   
 $y=1$

Your first reaction would be to simply press the *Enter* key. However, if you press the *Enter* key, though the markup goes to a new line, the resulting equation does not. You must type the newline command explicitly. This is illustrated in the table below.

Markup	Result
x = 3 y = 1	$x=3 y=1$
x = 3 newline y = 1	$x=3$ $y=1$

### How do I add limits to my sum/integral?

The sum and int commands can (optionally) take the parameters *from* and *to*. These are used for lower and upper limits respectively. These parameters can be used singly or together. Limits for integrals are usually treated as subscripts and superscripts.

Markup	Result
sum from k = 1 to n a_k	$\sum_{k=1}^n a_k$
int from 0 to x f(t) dt or int_0^x f(t) dt	$\int_0^x f(t) dt$ or $\int_0^x f(t) dt$
int from Re f	$\int_{\mathbb{R}} f$
sum to infinity 2^{-n}	$\sum_{n=0}^{\infty} 2^{-n}$

**Note** For more details on integrals and sums, see the *Math Guide*.

## Brackets with matrices look ugly!

For background, we start with an overview of the matrix command.

Markup	Result
matrix { a # b ## c # d }	$\begin{matrix} a & b \\ c & d \end{matrix}$

**Note** Rows are separated by two #'s and entries within each row are separated by one #.

The first problem people have with matrices is that brackets do not scale with the matrix.

Markup	Result
( matrix { a # b ## c # d } )	$\begin{pmatrix} a & b \\ c & d \end{pmatrix}$

Math provides scalable brackets. That is, the brackets grow in size to match the size of their contents. Use the commands *left*( and *right*) to make scalable brackets.

Markup	Result
left( matrix { a # b ## c # d } right)	$\left( \begin{matrix} a & b \\ c & d \end{matrix} \right)$

**Tip** Use *left[* and *right]* to obtain square brackets.

## How do I make a derivative?

Making derivatives essentially comes down to one trick: *Tell Math it's a fraction*.

In other words, you have to use the *over* command. Combine this with either the letter *d* (for a total derivative) or the *partial* command (for a partial derivative) to achieve the effect of a derivative.

**Note**

Notice that we have to use braces (squiggly brackets) to make the derivative.

<b>Markup</b>	<b>Result</b>
<code>{df} over {dx}</code>	$\frac{df}{dx}$
<code>{partial f} over {partial y}</code>	$\frac{\partial f}{\partial y}$
<code>{partial^2 f} over {partial t^2}</code>	$\frac{\partial^2 f}{\partial t^2}$

### How do I align my equations at the equals sign?

Math does not have a command for aligning equations on a particular character, but you can use a matrix to do this, as shown below.

<b>Markup</b>	<b>Result</b>
<code>matrix{   alignr x+y # {}={} # alignl 2 ##   alignr x # {}={} # alignl 2-y }</code>	$\begin{array}{rcl} x + y & = & 2 \\ x & = & 2 - y \end{array}$

The empty braces around = are necessary because = is a binary operator and thus needs an expression on each side.

You can reduce the spacing around = if you change the inter-column spacing of the matrix:

- 1) With the equation editor open, choose **Format** → **Spacing** from the menu bar.
- 2) In the Spacing dialog (Figure 16), click the **Category** button and select **Matrices** in the drop-down menu.
- 3) Enter **0%** for Column spacing and click **OK**.

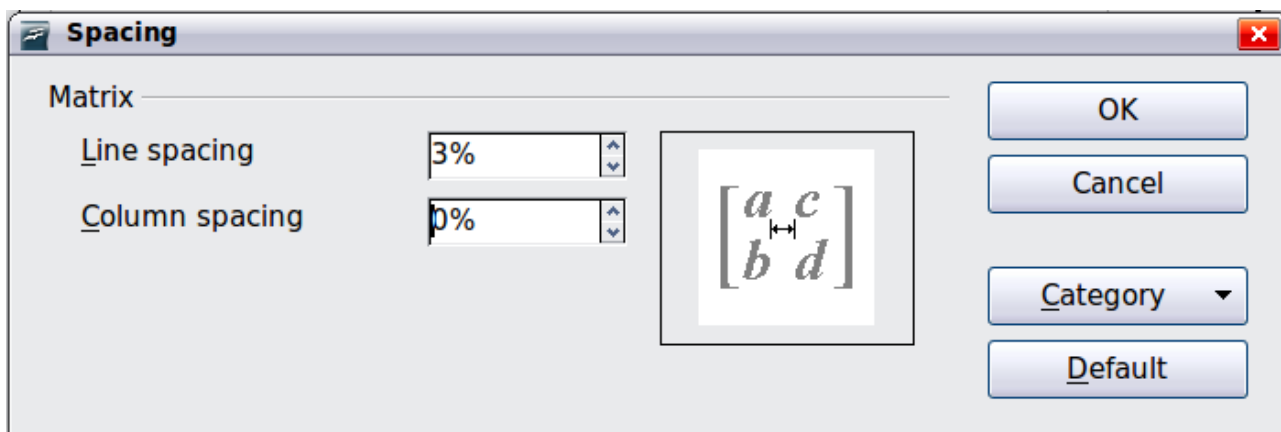

Figure 16: Changing spacing in a matrix formula

## Numbering equations

Equation numbering is one of Math's best hidden features. The steps are simple, but obscure:

- 1) Start a new line.
- 2) Type `fn` and then press `F3`.

The `fn` is replaced by a numbered formula:

$$E = mc^2 \tag{2}$$

Now you can double-click on the formula to edit it. For example, here is the Riemann Zeta function:

$$\zeta(z) = \sum_{n=1}^{\infty} \frac{1}{n^z} \tag{3}$$

You can reference an equation ("as shown in Equation (2)") with these steps:

- 1) Choose **Insert** → **Cross-reference** from the menu bar.
- 2) On the *Cross-references* tab (Figure 17), under *Type*, select *Text*.
- 3) Under *Selection*, select the equation number.
- 4) Under *Format*, select *Reference*.
- 5) Click **Insert**.

Done! If you later add more equations to the paper before the referenced equation, all the equations will automatically renumber and the cross-references will update.

### Tip

To insert the equation number without parenthesis around it, choose *Numbering* instead of *Reference* under *Format*.

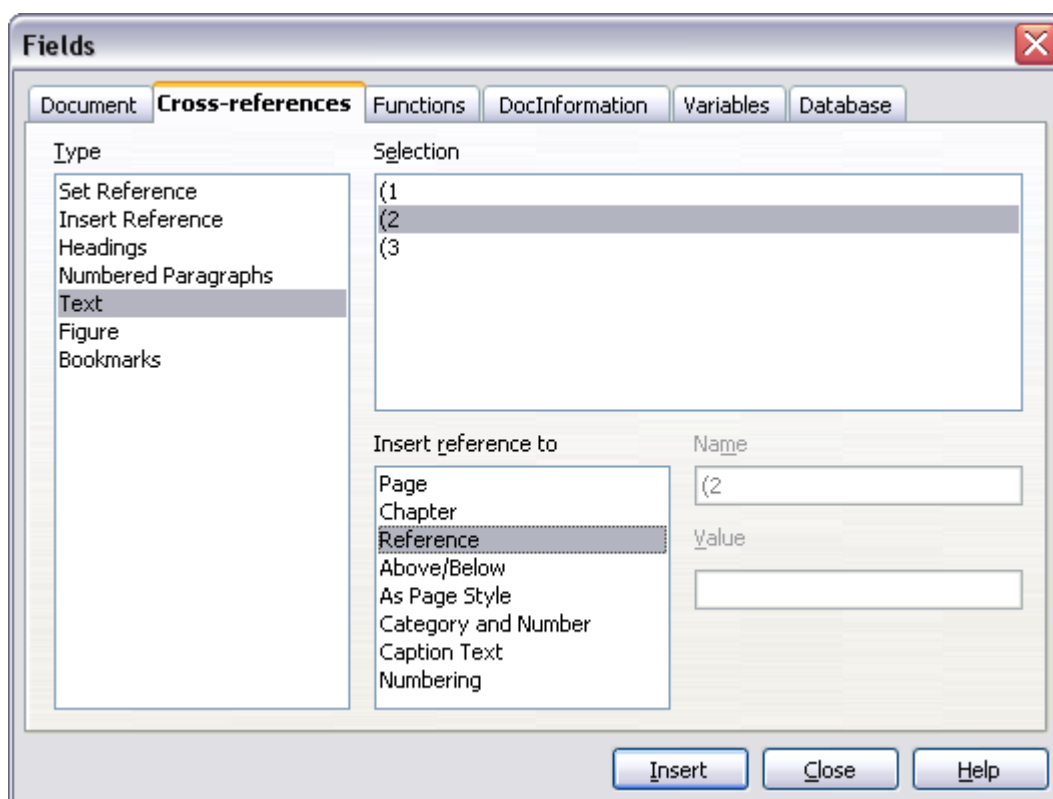

Figure 17. Inserting a cross-reference to an equation number